

# ***Nikon***

with **WARRANTY**

DIGITAL CAMERA

# **D850**

## **User's Manual (with Warranty)**

- Read this manual thoroughly before using the camera.
- To ensure proper use of the camera, be sure to read "For Your Safety" (page x).
- After reading this manual, keep it in a readily accessible place for future reference.

**En**

To get the most from your camera, please be sure to read all instructions thoroughly and keep them where they will be read by all who use the product.

### **Symbols and Conventions**

To make it easier to find the information you need, the following symbols and conventions are used:



This icon marks cautions; information that should be read before use to prevent damage to the camera.



This icon marks notes; information that should be read before using the camera.



This icon marks references to other sections in this manual.

Menu items, options, and messages displayed in the camera monitor are shown in **bold**.

Throughout this manual, smartphones and tablets are referred to as “smart devices”.

### **Camera Settings**

The explanations in this manual assume that default settings are used.

#### **For Your Safety**

Before using the camera for the first time, read the safety instructions in “For Your Safety” (□ x).

### **Nikon User Support**

Visit the site below to register your camera and keep up-to-date with the latest product information. You will find answers to frequently asked questions (FAQs) and can contact us for technical assistance.

*<http://www.europe-nikon.com/support>*

**D850 Model Name: N1608**

## ■ ■ **The Menu Guide (PDF)**

For more information on menu options and subjects such as how to connect the camera to a printer or television, download the camera *Menu Guide* from the Nikon website as described below. The *Menu Guide* is in pdf format and can be viewed using Adobe Reader or Adobe Acrobat Reader.



- 1 On your computer, launch a web browser and open the Nikon manual download site at <http://downloadcenter.nikonimglib.com/>
- 2 Navigate to the page for the desired product and download the manual.

## ■ ■ **Online Manuals (HTML)**

To view Nikon manuals in a web browser:

- 1 Launch the browser and open the Nikon manual site at <http://onlinemanual.nikonimglib.com/d850/en/>
- 2 Select the desired product and open the online manual.



### **Use Only Nikon Brand Accessories**

Only Nikon brand accessories certified by Nikon specifically for use with your Nikon digital camera are engineered and proven to operate within its operational and safety requirements. THE USE OF NON-NIKON ACCESSORIES COULD DAMAGE YOUR CAMERA AND MAY VOID YOUR NIKON WARRANTY.

## Package Contents

Be sure all items listed here were included with your camera.



- BF-1B body cap (1)

- D850 digital camera  
(1)

- 
- EN-EL15a rechargeable Li-ion battery with terminal cover (14, 16)
  - MH-25a battery charger (comes with either an AC wall adapter or power cable of a type and shape that varies with the country or region of sale; 14)
  - HDMI/USB cable clip
  - UC-E22 USB cable
  - AN-DC18 strap (14)
  - User's Manual (this guide)
  - SnapBridge Connection Guide (for D-SLR Cameras)
  - Warranty (printed on the back cover of this manual)

Purchasers of the lens kit option should confirm that the package also includes a lens. *Memory cards are sold separately.* Cameras purchased in Japan display menus and messages in English and Japanese only; other languages are not supported. We apologize for any inconvenience this may cause.

### ViewNX-i and Capture NX-D Computer Software

Use ViewNX-i to fine-tune photos or to copy pictures to a computer for viewing, or Capture NX-D to fine-tune pictures that have been copied to a computer and to convert NEF (RAW) images to other formats.

These applications are available for download from:

<http://downloadcenter.nikonimglib.com/>

You can also visit this website for the latest information on Nikon software, including system requirements.

# Table of Contents

Package Contents .....	ii
For Your Safety .....	x
Notices.....	xiv
<b>Introduction</b>	<b>1</b>
<hr/>	
<b>Getting to Know the Camera</b> .....	<b>1</b>
Camera Body .....	1
The Control Panel .....	5
The Viewfinder Display .....	7
The Diopter Adjustment Control .....	9
Using the Tilting Monitor.....	10
Using the Touch Screen .....	12
<b>First Steps</b>	<b>14</b>
<hr/>	
Attach the Camera Strap.....	14
Charge the Battery .....	14
Insert the Battery and a Memory Card .....	16
Attach a Lens .....	19
Basic Setup .....	21
<b>Tutorial</b>	<b>24</b>
<hr/>	
<b>Camera Menus: An Overview</b> .....	<b>24</b>
Using Camera Menus .....	25
<b>Basic Photography and Playback</b> .....	<b>30</b>
The Battery Level and Number of Exposures Remaining.....	30
“Point-and-Shoot” Photography.....	32
Viewing Photographs .....	35

---

<b>Autofocus</b> .....	<b>41</b>
Choosing a Focus Mode .....	41
Choosing an AF-Area Mode .....	42
<b>Manual Focus</b> .....	<b>44</b>
<b>Using the <i>i</i> Button</b> .....	<b>45</b>
Split-Screen Display Zoom.....	48
Silent Live View Photography.....	49
Negative Digitizer .....	52
<b>The Live View Display</b> .....	<b>54</b>
The Information Display .....	55
<b>Touch Photography (Touch Shutter)</b> .....	<b>56</b>
<b>Movies</b> .....	<b>59</b>

---

<b>Recording Movies</b> .....	<b>59</b>
Indices .....	64
Using the <i>i</i> Button .....	65
Image Area: Choosing a Movie Crop.....	68
Frame Size, Frame Rate, and Movie Quality .....	69
The Live View Display .....	71
The Information Display .....	72
Taking Photos in Movie Mode.....	73
<b>Viewing Movies</b> .....	<b>76</b>
<b>Editing Movies</b> .....	<b>78</b>
Trimming Movies .....	78
Saving Selected Frames .....	82

<b>Image Recording Options</b>	<b>83</b>
Image Area .....	83
Image Quality.....	88
Image Size.....	91
Using Two Memory Cards.....	93
<b>Focus</b>	<b>94</b>
Autofocus .....	94
Autofocus Mode.....	98
AF-Area Mode .....	100
Focus Point Selection .....	105
Focus Lock.....	108
Manual Focus .....	111
<b>Release Mode</b>	<b>113</b>
Choosing a Release Mode.....	113
Power Source and Frame Rate.....	114
Self-Timer Mode (⌚) .....	116
Mirror up Mode (MUP) .....	118
<b>ISO Sensitivity</b>	<b>119</b>
Manual Adjustment .....	119
Auto ISO Sensitivity Control .....	121

<b>Exposure</b>	<b>124</b>
Metering .....	124
Exposure Mode .....	126
P: Programmed Auto .....	128
S: Shutter-Priority Auto .....	129
A: Aperture-Priority Auto .....	130
M: Manual .....	131
Long Time-Exposures (M Mode Only) .....	133
Shutter-Speed and Aperture Lock .....	136
Autoexposure (AE) Lock .....	137
Exposure Compensation .....	139
Bracketing .....	142
<b>White Balance</b>	<b>156</b>
White Balance Options .....	156
Fine-Tuning White Balance .....	161
Choosing a Color Temperature .....	163
Preset Manual .....	165
Viewfinder Photography .....	166
Live View (Spot White Balance) .....	169
Managing Presets .....	172
<b>Image Enhancement</b>	<b>175</b>
Picture Controls .....	175
Selecting a Picture Control .....	175
Modifying Picture Controls .....	177
Preserving Detail in Highlights and Shadows .....	180
Active D-Lighting .....	180
High Dynamic Range (HDR) .....	182











<b>Optional Flash Units</b>	<b>187</b>
Using a Flash .....	187
On-Camera Flash Photography .....	190
Flash Modes .....	192
Flash Compensation .....	194
FV Lock .....	196
Flash Info for Shoe-Mounted Units.....	198
Remote Flash Units .....	202
<b>Other Shooting Options</b>	<b>203</b>
The  Button.....	203
Using the Command Dials .....	207
The <i>i</i> button .....	208
Two-Button Reset: Restoring Default Settings.....	209
Focus Shift Photography .....	212
Non-CPU Lenses .....	218
Location Data.....	221
<b>More About Playback</b>	<b>223</b>
Viewing Images .....	223
Full-Frame Playback.....	223
Thumbnail Playback .....	223
Playback Controls .....	224
Using the Touch Screen .....	226
The <i>i</i> Button.....	228
Photo Information .....	229
Taking a Closer Look: Playback Zoom.....	238
Protecting Photographs from Deletion .....	240

Rating Pictures .....	241
Selecting Photos for Upload.....	243
Selecting Individual Photos.....	243
Selecting Multiple Photos .....	244
Deleting Photographs .....	245
During Playback.....	245
The Playback Menu .....	246
<b>Menu List</b>	<b>248</b>

---

### Camera Menus

More information on camera menus is available in a *Menu Guide* that can be downloaded from the Nikon website ( i).

 The Playback Menu: Managing Images.....	248
 The Photo Shooting Menu: Shooting Options .....	250
 The Movie Shooting Menu: Movie Shooting Options.....	256
 Custom Settings: Fine-Tuning Camera Settings.....	260
 The Setup Menu: Camera Setup.....	271
 The Retouch Menu: Creating Retouched Copies.....	278
 My Menu/  Recent Settings .....	280

---

<b>Compatible Lenses.....</b>	<b>281</b>
<b>The Nikon Creative Lighting System (CLS).....</b>	<b>288</b>
<b>Other Accessories.....</b>	<b>296</b>
<b>Optional MB-D18 Battery Packs .....</b>	<b>299</b>
Parts of the MB-D18 .....	299
Using the Battery Pack.....	302
Specifications .....	310
<b>Caring for the Camera .....</b>	<b>311</b>
Storage .....	311
Cleaning .....	311
Image Sensor Cleaning.....	312
<b>Caring for the Camera and Battery: Cautions.....</b>	<b>319</b>
<b>Troubleshooting.....</b>	<b>324</b>
Battery/Display .....	324
Shooting .....	325
Playback .....	328
Bluetooth and Wi-Fi (Wireless Networks) .....	329
Miscellaneous .....	329
<b>Error Messages.....</b>	<b>330</b>
<b>Specifications.....</b>	<b>336</b>
<b>AF-S NIKKOR 24–120mm f/4G ED VR Lenses .....</b>	<b>351</b>
<b>Approved Memory Cards .....</b>	<b>360</b>
<b>Memory Card Capacity.....</b>	<b>362</b>
<b>Battery Life .....</b>	<b>365</b>
<b>Index.....</b>	<b>367</b>
<b>Warranty Terms - Nikon Europe Service Warranty.....</b>	<b>377</b>

## For Your Safety

To prevent damage to property or injury to yourself or to others, read "For Your Safety" in its entirety before using this product.

Keep these safety instructions where all those who use this product will read them.

**⚠ DANGER:** Failure to observe the precautions marked with this icon carries a high risk of death or severe injury.

**⚠ WARNING:** Failure to observe the precautions marked with this icon could result in death or severe injury.

**⚠ CAUTION:** Failure to observe the precautions marked with this icon could result in injury or property damage.



### WARNING

**• Do not use while walking or operating a motor vehicle.**

Failure to observe this precaution could result in accidents or other injury.

**• Do not disassemble or modify this product. Do not touch internal parts that become exposed as the result of a fall or other accident.**

Failure to observe these precautions could result in electric shock or other injury.

**• Should you notice any abnormalities such as the product producing smoke, heat, or unusual odors, immediately disconnect the battery or power source.**

Continued operation could result in fire, burns or other injury.

**• Keep dry. Do not handle with wet hands. Do not handle the plug with wet hands.**

Failure to observe these precautions could result in fire or electric shock.

**• Do not let your skin remain in prolonged contact with this product while it is on or plugged in.**

Failure to observe this precaution could result in low-temperature burns.

**• Do not use this product in the presence of flammable dust or gas such as propane, gasoline or aerosols.**

Failure to observe this precaution could result in explosion or fire.

- **Do not directly view the sun or other bright light source through the lens or camera.**

Failure to observe this precaution could result in visual impairment.

---

- **Do not aim the flash or AF-assist illuminator at the operator of a motor vehicle.**

Failure to observe this precaution could result in accidents.

---

- **Keep this product out of reach of children.**

Failure to observe this precaution could result in injury or product malfunction. In addition, note that small parts constitute a choking hazard. Should a child swallow any part of this product, seek immediate medical attention.

---

- **Do not entangle, wrap or twist the straps around your neck.**

Failure to observe this precaution could result in accidents.

---

- **Do not use batteries, chargers, or AC adapters not specifically designated for use with this product. When using batteries, chargers, and AC adapters designated for use with this product, do not:**

- **Damage, modify, forcibly tug or bend the cords or cables, place them under heavy objects, or expose them to heat or flame.**
- **Use travel converters or adapters designed to convert from one voltage to another or with DC-to-AC inverters.**

Failure to observe these precautions could result in fire or electric shock.

---

- **Do not handle the plug when charging the product or using the AC adapter during thunderstorms.**

Failure to observe this precaution could result in electric shock.

---

- **Do not handle with bare hands in locations exposed to extremely high or low temperatures.**

Failure to observe this precaution could result in burns, or frostbite.

---



## CAUTION

- **Do not leave the lens pointed at the sun or other strong light sources.**

Light focused by the lens could cause fire or damage to product's internal parts. When shooting backlit subjects, keep the sun well out of the frame. Sunlight focused into the camera when the sun is close to the frame could cause fire.

---

- **Turn this product off when its use is prohibited. Disable wireless features when the use of wireless equipment is prohibited.**

The radio-frequency emissions produced by this product could interfere with equipment onboard aircraft or in hospitals or other medical facilities.

---

- **Remove the battery and disconnect the AC adapter if this product will not be used for an extended period.**

Failure to observe this precaution could result in fire or product malfunction.

---

- **Do not touch moving parts of the lens or other moving parts.**

Failure to observe this precaution could result in injury.

---

- **Do not fire the flash in contact with or in close proximity to the skin or objects.**

Failure to observe this precaution could result in burns or fire.

---

- **Do not leave the product where it will be exposed to extremely high temperatures, for an extended period such as in an enclosed automobile or in direct sunlight.**

Failure to observe this precaution could result in fire or product malfunction.

---



## **DANGER (Batteries)**

- **Do not mishandle batteries.**

Failure to observe the following precautions could result in the batteries leaking, overheating, rupturing, or catching fire:

- Use only rechargeable batteries approved for use in this product.
  - Do not expose batteries to flame or excessive heat.
  - Do not disassemble.
  - Do not short-circuit the terminals by touching them to necklaces, hairpins, or other metal objects.
  - Do not expose batteries or the products in which they are inserted to powerful physical shocks.
- 

- **Do not attempt to recharge EN-EL15a rechargeable batteries using chargers not specifically designated for this purpose.**

Failure to observe this precaution could result in the batteries leaking, overheating, rupturing, or catching fire.

---

- **If battery liquid comes into contact with the eyes, rinse with plenty of clean water and seek immediate medical attention.**

Delaying action could result in eye injuries.

---



## WARNING (Batteries)

- **Keep batteries out of reach of children.**

Should a child swallow a battery, seek immediate medical attention.

- **Do not immerse batteries in water or expose to rain.**

Failure to observe this precaution could result in fire or product malfunction. Immediately dry the product with a towel or similar object should it become wet.

- **Discontinue use immediately should you notice any changes in the batteries, such as discoloration or deformation. Cease charging EN-EL15a rechargeable batteries if they do not charge in the specified period of time.**

Failure to observe these precautions could result in the batteries leaking, overheating, rupturing, or catching fire.

- **Prior to disposal, insulate battery terminals with tape.**

Overheating, rupture, or fire may result should metal objects come into contact with the terminals. Recycle or dispose of batteries in accord with local regulations.

- **If battery liquid comes into contact with a person's skin or clothing, immediately rinse the affected area with plenty of clean water.**

Failure to observe this precaution could result in skin irritation.

## Notices

- No part of the manuals included with this product may be reproduced, transmitted, transcribed, stored in a retrieval system, or translated into any language in any form, by any means, without Nikon's prior written permission.
- Nikon reserves the right to change the appearance and specifications of the hardware and software described in these manuals at any time and without prior notice.
- Nikon will not be held liable for any damages resulting from the use of this product.
- While every effort has been made to ensure that the information in these manuals is accurate and complete, we would appreciate it were you to bring any errors or omissions to the attention of the Nikon representative in your area (address provided separately).

### **Notice for Customers in Canada**

CAN ICES-3 B / NMB-3 B

### **Notices for Customers in Europe**

**CAUTION: RISK OF EXPLOSION IF BATTERY IS REPLACED BY AN INCORRECT TYPE. DISPOSE OF USED BATTERIES ACCORDING TO THE INSTRUCTIONS.**

This symbol indicates that electrical and electronic equipment is to be collected separately.



The following apply only to users in European countries:

- This product is designated for separate collection at an appropriate collection point. Do not dispose of as household waste.
- Separate collection and recycling helps conserve natural resources and prevent negative consequences for human health and the environment that might result from incorrect disposal.
- For more information, contact the retailer or the local authorities in charge of waste management.

This symbol on the battery indicates that the battery is to be collected separately.



The following apply only to users in European countries:

- All batteries, whether marked with this symbol or not, are designated for separate collection at an appropriate collection point. Do not dispose of as household waste.
- For more information, contact the retailer or the local authorities in charge of waste management.



## Notices for Customers in the U.S.A.

### The Battery Charger

## IMPORTANT SAFETY INSTRUCTIONS—SAVE THESE INSTRUCTIONS

## DANGER—TO REDUCE THE RISK OF FIRE OR ELECTRIC SHOCK, CAREFULLY FOLLOW THESE INSTRUCTIONS

For connection to a supply not in the U.S.A., use an attachment plug adapter of the proper configuration for the power outlet if needed. This power unit is intended to be correctly oriented in a vertical or floor mount position.

### Federal Communications Commission (FCC) Radio Frequency Interference Statement

This equipment has been tested and found to comply with the limits for a Class B digital device, pursuant to Part 15 of the FCC rules. These limits are designed to provide reasonable protection against harmful interference in a residential installation. This equipment generates, uses, and can radiate radio frequency energy and, if not installed and used in accordance with the instructions, may cause harmful interference to radio communications. However, there is no guarantee that interference will not occur in a particular installation. If this equipment does cause harmful interference to radio or television reception, which can be determined by turning the equipment off and on, the user is encouraged to try to correct the interference by one or more of the following measures:

- Reorient or relocate the receiving antenna.
- Increase the separation between the equipment and receiver.
- Connect the equipment into an outlet on a circuit different from that to which the receiver is connected.
- Consult the dealer or an experienced radio/television technician for help.



**Nikon**  
D850

#### CAUTIONS

##### *Modifications*

The FCC requires the user be notified that any changes or modifications made to this device that are not expressly approved by Nikon Corporation may void the user's authority to operate the equipment.

##### *Interface Cables*

Use the interface cables sold or provided by Nikon for your equipment. Using other interface cables may exceed the limits of Class B Part 15 of the FCC rules.

##### **Notice for Customers in the State of California**

**WARNING:** Handling the cord on this product may expose you to lead, a chemical known to the State of California to cause birth defects or other reproductive harm. *Wash hands after handling.*

Nikon Inc., 1300 Walt Whitman Road, Melville, New York 11747-3064, U.S.A.  
Tel.: 631-547-4200

## **Power Cable**

**At voltages over AC 125 V (U.S.A. only):** The power cable must be rated for the voltage in use, be at least AWG no. 18 gauge, and have SVG insulation or better with a NEMA 6P-15 plug rated for AC 250 V 15 A.

## **Notice Concerning Prohibition of Copying or Reproduction**

Note that simply being in possession of material that has been digitally copied or reproduced by means of a scanner, digital camera, or other device may be punishable by law.

### **• Items prohibited by law from being copied or reproduced**

Do not copy or reproduce paper money, coins, securities, government bonds, or local government bonds, even if such copies or reproductions are stamped "Sample."

The copying or reproduction of paper money, coins, or securities which are circulated in a foreign country is prohibited.

Unless the prior permission of the government has been obtained, the copying or reproduction of unused postage stamps or post cards issued by the government is prohibited.

The copying or reproduction of stamps issued by the government and of certified documents stipulated by law is prohibited.

### **• Cautions on certain copies and reproductions**

The government has issued cautions on copies or reproductions of securities issued by private companies (shares, bills, checks, gift certificates, etc.), commuter passes, or coupon tickets, except when a minimum of necessary copies are to be provided for business use by a company. Also, do not copy or reproduce passports issued by the government, licenses issued by public agencies and private groups, ID cards, and tickets, such as passes and meal coupons.

### **• Comply with copyright notices**

Under copyright law, photographs or recordings of copyrighted works made with the camera cannot be used without the permission of the copyright holder. Exceptions apply to personal use, but note that even personal use may be restricted in the case of photographs or recordings of exhibits or live performances.

### ***Disposing of Data Storage Devices***

Please note that deleting images or formatting memory cards or other data storage devices does not completely erase the original image data. Deleted files can sometimes be recovered from discarded storage devices using commercially available software, potentially resulting in the malicious use of personal image data. Ensuring the privacy of such data is the user's responsibility.

Before discarding a data storage device or transferring ownership to another person, erase all data using commercial deletion software, or format the device and then completely refill it with images containing no private information (for example, pictures of empty sky). Care should be taken to avoid injury when physically destroying data storage devices.

Before discarding the camera or transferring ownership to another person, you should also use the **Reset all settings** option in the camera setup menu to delete any personal network information.

## **AVC Patent Portfolio License**

THIS PRODUCT IS LICENSED UNDER THE AVC PATENT PORTFOLIO LICENSE FOR THE PERSONAL AND NON-COMMERCIAL USE OF A CONSUMER TO (i) ENCODE VIDEO IN COMPLIANCE WITH THE AVC STANDARD ("AVC VIDEO") AND/OR (ii) DECODE AVC VIDEO THAT WAS ENCODED BY A CONSUMER ENGAGED IN A PERSONAL AND NON-COMMERCIAL ACTIVITY AND/OR WAS OBTAINED FROM A VIDEO PROVIDER LICENSED TO PROVIDE AVC VIDEO. NO LICENSE IS GRANTED OR SHALL BE IMPLIED FOR ANY OTHER USE. ADDITIONAL INFORMATION MAY BE OBTAINED FROM MPEG LA, L.L.C. SEE <http://www.mpegla.com>

## **Use Only Nikon Brand Electronic Accessories**

Nikon cameras are designed to the highest standards and include complex electronic circuitry. Only Nikon brand electronic accessories (including chargers, batteries, AC adapters, and flash accessories) certified by Nikon specifically for use with this Nikon digital camera are engineered and proven to operate within the operational and safety requirements of this electronic circuitry.

The use of non-Nikon electronic accessories could damage the camera and may void your Nikon warranty. The use of third-party rechargeable Li-ion batteries not bearing the Nikon holographic seal shown at right could interfere with normal operation of the camera or result in the batteries overheating, igniting, rupturing, or leaking.

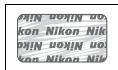

For more information about Nikon brand accessories, contact a local authorized Nikon dealer.

### 🔍 **Before Taking Important Pictures**

Before taking pictures on important occasions (such as at weddings or before taking the camera on a trip), take a test shot to ensure that the camera is functioning normally. Nikon will not be held liable for damages or lost profits that may result from product malfunction.

### 🔍 **Life-Long Learning**

As part of Nikon's "Life-Long Learning" commitment to ongoing product support and education, continually-updated information is available on-line at the following sites:

- **For users in the U.S.A.:** <http://www.nikonusa.com/>
- **For users in Europe and Africa:** <http://www.europe-nikon.com/support/>
- **For users in Asia, Oceania, and the Middle East:** <http://www.nikon-asia.com/>

Visit these sites to keep up-to-date with the latest product information, tips, answers to frequently-asked questions (FAQs), and general advice on digital imaging and photography. Additional information may be available from the Nikon representative in your area. See the following URL for contact information: <http://imaging.nikon.com/>

## ■ ■ **Bluetooth and Wi-Fi (Wireless LAN)**

This product is controlled by the United States Export Administration Regulations (EAR). The permission of the United States government is not required for export to countries other than the following, which as of this writing are subject to embargo or special controls: Cuba, Iran, North Korea, Sudan, and Syria (list subject to change).

The use of wireless devices may be prohibited in some countries or regions. Contact a Nikon-authorized service representative before using the wireless features of this product outside the country of purchase.

### **Notice for Customers in the U.S.A. and Canada**

This device complies with part 15 of FCC Rules and Industry Canada's licence-exempt RSSs. Operation is subject to the following two conditions: (1) this device may not cause harmful interference, and (2) this device must accept any interference received, including interference that may cause undesired operation.

### **FCC WARNING**

The FCC requires the user to be notified that any changes or modifications made to this device that are not expressly approved by Nikon Corporation may void the user's authority to operate the equipment.

### **FCC Radio Frequency Interference Statement**

Note: This equipment has been tested and found to comply with the limits for a Class B digital device, pursuant to part 15 of the FCC Rules. These limits are designed to provide reasonable protection against harmful interference in a residential installation. This equipment generates, uses and can radiate radio frequency energy and, if not installed and used in accordance with the instructions, may cause harmful interference to radio communications. However, there is no guarantee that interference will not occur in a particular installation. If this equipment does cause harmful interference to radio or television reception, which can be determined by turning the equipment off and on, the user is encouraged to try to correct the interference by one or more of the following measures:

- Reorient or relocate the receiving antenna.
- Increase the separation between the equipment and receiver.
- Connect the equipment into an outlet on a circuit different from that to which the receiver is connected.
- Consult the dealer or an experienced radio/TV technician for help.

### **Co-location**

This transmitter must not be co-located or operated in conjunction with any other antenna or transmitter.

Nikon Inc., 1300 Walt Whitman Road, Melville, New York 11747-3064, U.S.A.  
Tel.: 631-547-4200

### **FCC/IC RF Exposure Statement**

The available scientific evidence does not show that any health problems are associated with using low power wireless devices. There is no proof, however, that these low power wireless devices are absolutely safe. Low power Wireless devices emit low levels of radio frequency energy (RF) in the microwave range while being used. Whereas high levels of RF can produce health effects (by heating tissue), exposure of low-level RF that does not produce heating effects causes no known adverse health effects. Many studies of low-level RF exposures have not found any biological effects. Some studies have suggested that some biological effects might occur, but such findings have not been confirmed by additional research. This product has been tested and found to comply with FCC/IC radiation exposure limits set forth for an uncontrolled environment and meets the FCC radio frequency (RF) Exposure Guidelines and RSS-102 of the IC radio frequency (RF) Exposure rules. Please refer to the SAR test report that was uploaded to FCC website.

### **Notices for Customers in Europe**

Hereby, Nikon Corporation declares that the radio equipment type D850 is in compliance with Directive 2014/53/EU.



The full text of the EU declaration of conformity is available at the following internet address: [http://imaging.nikon.com/support/pdf/DoC\\_D850.pdf](http://imaging.nikon.com/support/pdf/DoC_D850.pdf).

### **Notice for Customers in Singapore**

Trade Name: **Nikon**  
Model: D850

This device complies with radio-frequency regulations. The content of certification labels not affixed to the device is given below.

Complies with  
IMDA Standards  
DA103423

### **Notice for Customers in Nigeria**

Connection and use of this communications  
equipment is permitted by the Nigerian  
Communications Commission

## **Security**

Although one of the benefits of this product is that it allows others to freely connect for the wireless exchange of data anywhere within its range, the following may occur if security is not enabled:

- **Data theft:** Malicious third-parties may intercept wireless transmissions to steal user IDs, passwords, and other personal information.
- **Unauthorized access:** Unauthorized users may gain access to the network and alter data or perform other malicious actions. Note that due to the design of wireless networks, specialized attacks may allow unauthorized access even when security is enabled.
- **Unsecured networks:** Connecting to open networks may result in unauthorized access. Use secure networks only.



# Introduction

## Getting to Know the Camera

Take a few moments to familiarize yourself with camera controls and displays. You may find it helpful to bookmark this section and refer to it as you read through the rest of the manual.

### Camera Body

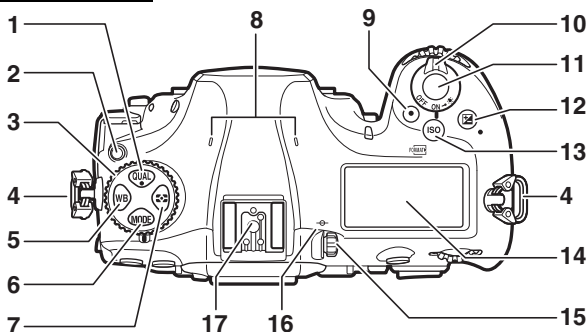

<b>1</b> QUAL button .....	88, 91	<b>10</b> Power switch .....	21
<b>2</b> Release mode dial lock release .....	113	<b>11</b> Shutter-release button .....	32
<b>3</b> Release mode dial .....	113	<b>12</b> button .....	139, 209
<b>4</b> Eyelet for camera strap .....	14	<b>13</b> ISO /  button .....	119, 271
<b>5</b> WB button .....	156	<b>14</b> Control panel .....	5
<b>6</b> MODE button .....	126	<b>15</b> Diopter adjustment control .....	9
<b>7</b> button .....	124	<b>16</b> Focal plane mark () .....	112
<b>8</b> Stereo microphone .....	65	<b>17</b> Accessory shoe .....	
<b>9</b> Movie-record button .....	59	(for optional flash unit) ...	187, 296

## Camera Body (Continued)

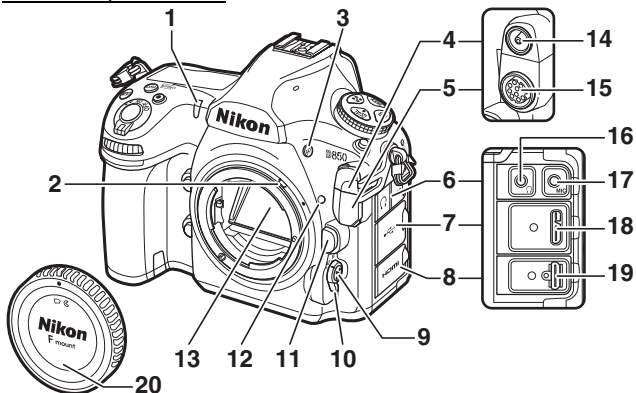

<b>1</b> Self-timer lamp ..... 116	<b>12</b> Lens mounting mark ..... 19
<b>2</b> Meter coupling lever	<b>13</b> Mirror..... 118, 315
<b>3</b> BKT button ..... 142	<b>14</b> Flash sync terminal ..... 188
<b>4</b> Flash sync terminal cover ..... 188	<b>15</b> Ten-pin remote terminal ..... 296
<b>5</b> Ten-pin remote terminal cover	<b>16</b> Headphone connector ..... 67, 72
<b>6</b> Audio connector cover	<b>17</b> Connector for external microphone ..... 296
<b>7</b> USB connector cover	<b>18</b> USB connector ..... 296
<b>8</b> HDMI connector cover	<b>19</b> HDMI connector ..... 296
<b>9</b> AF-mode button ..... 41, 42, 98, 100	<b>20</b> Body cap..... 19, 296
<b>10</b> Focus-mode selector ..... 41, 94, 111	
<b>11</b> Lens release button.....20	

### **✓ Close the Connector Cover**

Close the connector cover when the connectors are not in use. Foreign matter in the connectors can interfere with data transfer.

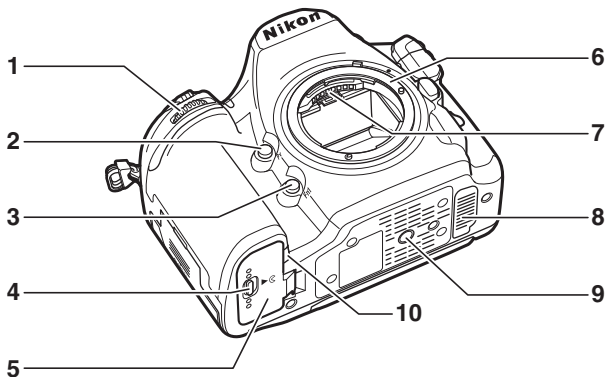

- |  |   |
|--|---|
| <b>1</b> Sub-command dial                        | <b>7</b> CPU contacts   |
| <b>2</b> <b>P</b> button ..... 44, 127, 268, 270 | <b>8</b> Contact cover for optional MB-D18 multi-power battery pack ..... 299 |
| <b>3</b> <b>Fn1</b> button ..... 268, 270        | <b>9</b> Tripod socket  |
| <b>4</b> Battery-chamber cover latch ..... 16    | <b>10</b> Power connector cover   |
| <b>5</b> Battery-chamber cover ..... 16, 18      |   |
| <b>6</b> Lens mount ..... 19, 112                |   |

#### **✓ The Speaker**

Do not place the speaker in close proximity to magnetic devices. Failure to observe this precaution could affect the data recorded on the magnetic devices.

## Camera Body (Continued)

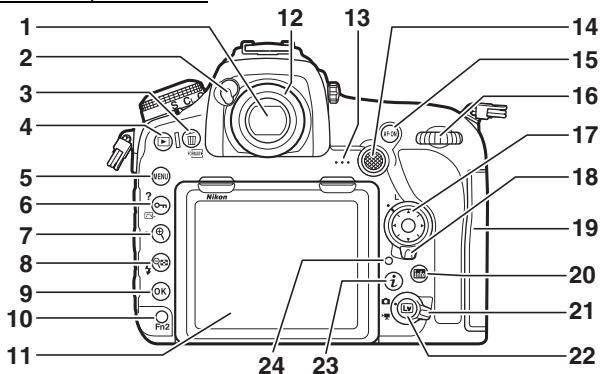

<b>1</b> Viewfinder .....7, 9, 116	<b>14</b> Sub-selector ..... 106, 108, 137, 268, 270
<b>2</b> Eyepiece shutter lever ..... 116	<b>15</b> <b>AF-ON</b> button .....99, 109, 261, 268
<b>3</b> /  button .....36, 245, 271	<b>16</b> Main command dial
<b>4</b> button .....35, 223	<b>17</b> Multi selector ..... 25, 34, 268, 269
<b>5</b> <b>MENU</b> button .....24, 248	<b>18</b> Focus selector lock ..... 105
<b>6</b> /  /  button .....25, 175, 240	<b>19</b> Memory card slot cover ..... 16, 18
<b>7</b> button .....40, 238	<b>20</b> button ..... 55, 72, 198, 203
<b>8</b> /  button ..... 192, 194, 223, 238	<b>21</b> Live view selector ..... 37, 59
<b>9</b> button .....25, 224	<b>22</b> button ..... 37, 59, 169, 270
<b>10</b> <b>Fn2</b> button ..... 242, 268, 270	<b>23</b> button ..... 45, 65, 208, 228
<b>11</b> Tilting monitor ...10, 12, 37, 59, 223	<b>24</b> Memory card access lamp .....32
<b>12</b> Viewfinder eyepiece .....9, 116	
<b>13</b> Speaker ..... 3, 76	

## The Control Panel

The control panel shows a variety of camera settings when the camera is on. The items shown here appear the first time the camera is turned on; information on other settings can be found in the relevant sections of this manual.

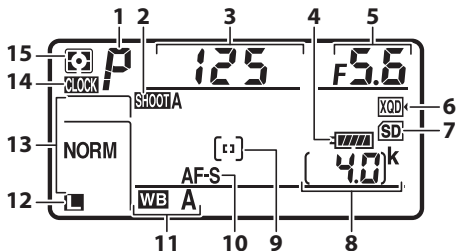



1	Exposure mode .....	126	9	AF-area mode .....	100
2	Photo shooting menu bank .....	250	10	Autofocus mode .....	98
3	Shutter speed .....	129, 131	11	White balance.....	156
4	Battery indicator .....	30	12	Image size (JPEG and TIFF images) .....	91
5	Aperture (f-number) .....	130, 131	13	Image quality .....	88
6	XQD card icon .....	16, 93	14	<b>CLOCK</b> ("clock not set") indicator	
7	SD card icon .....	16, 93	15	Metering .....	124
8	Number of exposures remaining .....	31, 362			

### The **CLOCK** ("clock not set") Indicator

The camera clock is powered by an independent, rechargeable power source, which is charged as necessary when the main battery is installed or the camera is powered by an optional power connector and AC adapter (□ 296). Two days of charging will power the clock for about three months. If the **CLOCK** icon flashes in the control panel, the clock has been reset and the date and time recorded with any new photographs will not be correct. Set the clock to the correct time and date using the **Time zone and date > Date and time** option in the setup menu (□ 271).

### LCD Illuminators

Rotating the power switch toward  activates the backlights for the buttons and control panel, making it easier to use the camera in the dark.

After the power switch is released, the backlights will remain lit for a few seconds while the standby timer is active or until the shutter is released or the power switch is rotated toward  again.

*Power switch*

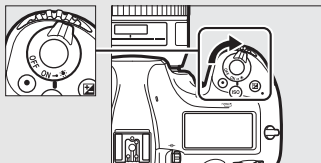

### The Control Panel and Viewfinder Displays

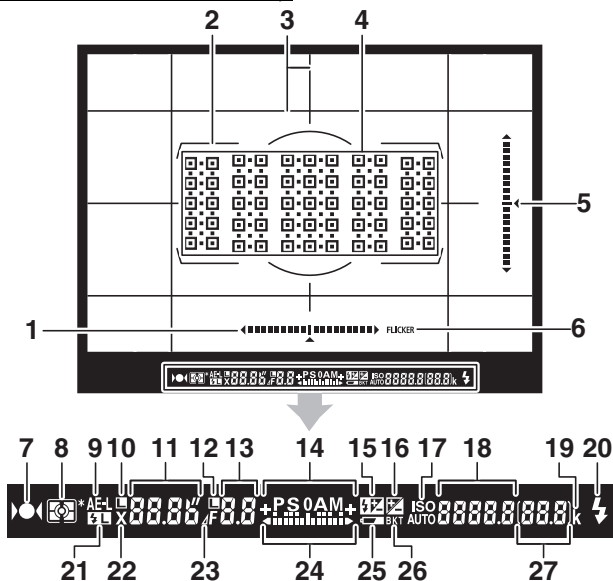

The brightness of the control panel and viewfinder displays varies with temperature, and the response times of the displays may drop at low temperatures. This is normal and does not indicate a malfunction.

## The Viewfinder Display



1	Roll indicator <sup>1,2</sup>	8	Metering .....	124	
2	AF area brackets .....	9	9	Autoexposure (AE) lock .....	137
3	Framing grid (displayed when <b>On</b> is selected for Custom Setting d9, <b>Viewfinder grid display</b> ) ...	265	10	Shutter speed lock icon ...	136, 268
4	Focus points .....	94, 105, 261	11	Shutter speed .....	129, 131
5	Pitch indicator <sup>1,3</sup>			Autofocus mode .....	98
6	Flicker detection .....	254	12	Aperture lock icon .....	136, 268
7	Focus indicator .....	32, 108, 112	13	Aperture (f-number) .....	130, 131
				Aperture (number of stops) .....	130

14	Exposure mode .....	126	22	Flash sync indicator .....	266
15	Flash compensation indicator .....	194	23	Aperture stop indicator .....	130
16	Exposure compensation indicator .....	139	24	Exposure indicator .....	132
17	ISO sensitivity indicator .....	119		Exposure compensation display.....	139
	Auto ISO sensitivity indicator .....	121	25	Low battery warning .....	30
18	ISO sensitivity .....	119	26	Exposure/flash bracketing indicator .....	143
	Preset white balance recording indicator .....	165		WB bracketing indicator .....	148
	Active D-Lighting amount .....	180		ADL bracketing indicator .....	152
	AF-area mode .....	100	27	Number of exposures remaining.....	31, 362
19	"k" (appears when memory remains for over 1000 exposures).....	31		Number of shots remaining before memory buffer fills .....	115, 362
20	Flash-ready indicator <sup>4</sup> .....	187		Exposure compensation value .....	139
21	FV lock indicator .....	196		Flash compensation value .....	194
				PC mode indicator	

- 1 Can be displayed by pressing a button to which **Viewfinder virtual horizon** has been assigned using Custom Setting f1 (**Custom control assignment**,  268).
- 2 Functions as a pitch indicator when camera is rotated to take pictures in "tall" (portrait) orientation.
- 3 Functions as a roll indicator when camera is rotated to take pictures in "tall" (portrait) orientation.
- 4 Displayed when an optional flash unit is attached ( 187). The flash-ready indicator lights when the flash is charged.

**Note:** Display shown with all indicators lit for illustrative purposes.

### **No Battery**

When the battery is totally exhausted or no battery is inserted, the display in the viewfinder will dim. This is normal and does not indicate a malfunction. The viewfinder display will return to normal when a fully-charged battery is inserted.



## The Diopter Adjustment Control

Lift the diopter adjustment control and rotate it until the viewfinder display, focus points, and AF area brackets are in sharp focus. When operating the control with your eye to the viewfinder, be careful not to put your fingers or fingernails in your eye. Push the diopter adjustment control back in once you have adjusted focus to your satisfaction.

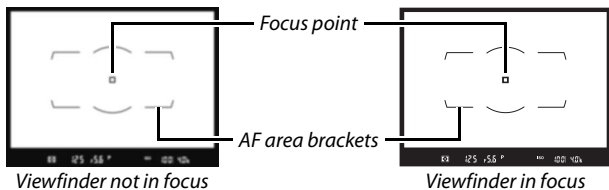
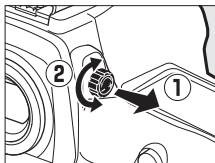

### Diopter-Adjustment Viewfinder Lenses

Corrective lenses (available separately;  296) can be used to further adjust viewfinder diopter. Before attaching a diopter-adjustment viewfinder lens, remove the DK-17F viewfinder eyepiece by closing the viewfinder shutter to release the eyepiece lock (1) and then grasping the eyepiece lightly between your finger and thumb and unscrewing it as shown (2).

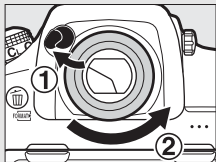

## Using the Tilting Monitor

The monitor can be angled and rotated as shown below.

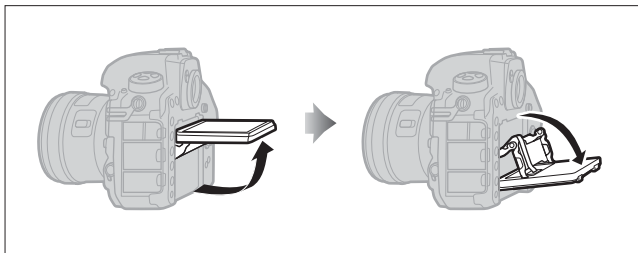

**Normal use:** The monitor is normally used in storage position.

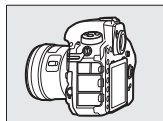

**Low-angle shots:** Tilt the monitor up to take shots in live view with the camera held low.

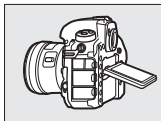

**High-angle shots:** Tilt the monitor down to take shots in live view with the camera held high.

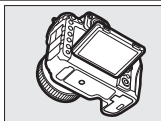

### ✔ Using the Monitor

Rotate the monitor gently, stopping when you feel resistance. *Do not use force.* Failure to observe these precautions could damage the camera or monitor. If the camera is mounted on a tripod, care should be taken to ensure that the monitor does not contact the tripod.

Do not lift or carry the camera by the monitor. Failure to observe this precaution could damage the camera. If the monitor is not being used to take photographs, return it to the storage position.

Do not touch the area to the rear of the monitor or allow liquid to contact the inner surface. Failure to observe these precautions could cause product malfunction.

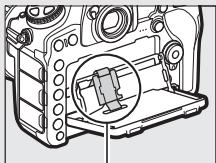

*Be particularly careful not to touch this area.*

## Using the Touch Screen

The touch-sensitive monitor supports the following operations:

---

### **Flick**

Flick a finger a short distance left or right across the monitor.

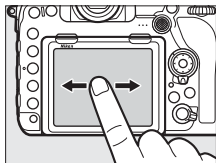

### **Slide**

Slide a finger over the monitor.

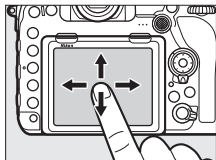

### **Stretch/Pinch**

Place two fingers on the monitor and move them apart or pinch them together.

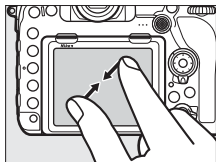
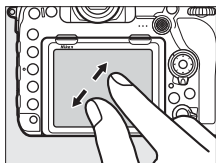

## ■ ■ Using the Touch Screen

During playback (📖 226), the touch screen can be used to:

- View other images
- Zoom in or out
- View thumbnails
- View movies

During live view, the touch screen can be used to take pictures (touch shutter; 📖 56) or to measure a value for spot white balance (📖 169). The touch screen can also be used for typing (📖 273) or navigating the menus (📖 29).

### ☑ The Touch Screen

The touch screen responds to static electricity and may not respond when covered with third-party protective films or when touched with fingernails or gloved hands. Do not use excessive force or touch the screen with sharp objects.

### ☑ Using the Touch Screen

The touch screen may not respond as expected if you attempt to operate it while leaving your palm or another finger resting on it in second location. It may not recognize other gestures if your touch is too soft, your fingers are moved too quickly or too short a distance or do not remain in contact with the screen, or if the movement of the two fingers in a pinch or stretch is not correctly coordinated.

### ☑ Enabling or Disabling Touch Controls

Touch controls can be enabled or disabled using the **Touch controls** option in the setup menu (📖 274).

### ☑ See Also

For information on choosing the direction you flick your finger to view other images in full-frame playback, see 📖 > **Touch controls** (📖 274).

# First Steps

## Attach the Camera Strap

Attach the strap securely to the camera eyelets.

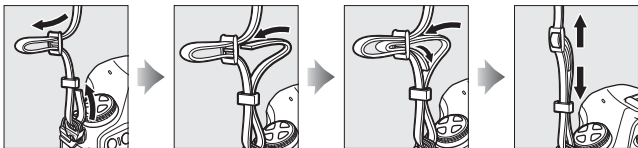

## Charge the Battery

Insert the battery and plug the charger in (depending on the country or region, the charger comes with either an AC wall adapter or a power cable). An exhausted battery will fully charge in about two hours and 35 minutes.

- **AC wall adapter:** Insert the AC wall adapter into the charger AC inlet (1). Slide the AC wall adapter latch as shown (2) and rotate the adapter 90° to fix it in place (3). Insert the battery and plug the charger in.

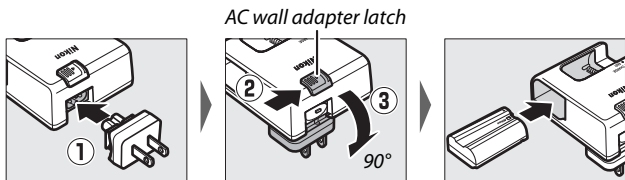

- **Power cable:** After connecting the power cable with the plug in the orientation shown, insert the battery and plug the cable in.

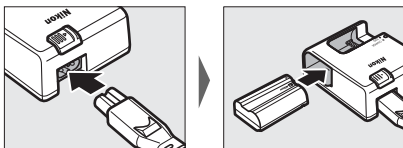

The **CHARGE** lamp will flash while the battery charges.

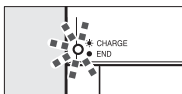

*Battery charging*

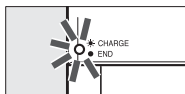

*Charging complete*

#### **✓ The Battery and Charger**

Read and follow the warnings and cautions in "For Your Safety" (☞ x) and "Caring for the Camera and Battery: Cautions" (☞ 319).

## Insert the Battery and a Memory Card

Before inserting or removing the battery or memory cards, confirm that power switch is in the **OFF** position. Insert the battery in the orientation shown, using the battery to keep the orange battery latch pressed to one side. The latch locks the battery in place when the battery is fully inserted.

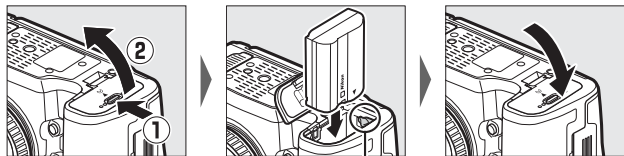

*Battery latch*

Holding the memory card in the orientation shown, slide it straight into the appropriate slot until it clicks into place.

### • XQD memory cards:

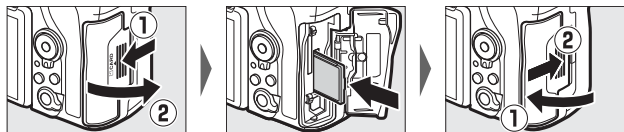

### • SD memory cards:

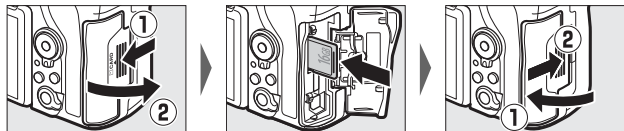



## ✔ Memory Cards

- Memory cards may be hot after use. Observe due caution when removing memory cards from the camera.
- Turn the power off before inserting or removing memory cards. Do not remove memory cards from the camera, turn the camera off, or remove or disconnect the power source during formatting or while data are being recorded, deleted, or copied to a computer. Failure to observe these precautions could result in loss of data or in damage to the camera or card.
- Do not touch the card terminals with your fingers or metal objects.
- Do not bend, drop, or subject to strong physical shocks.
- Do not apply force to the card casing. Failure to observe this precaution could damage the card.
- Do not expose to water, high levels of humidity, or direct sunlight.
- Do not format memory cards in a computer.

## ✔ The Write Protect Switch

SD memory cards are equipped with a write protect switch to prevent accidental loss of data. When this switch is in the “lock” position, the memory card cannot be formatted and photos cannot be deleted or recorded (a warning will be displayed in the monitor if you attempt to release the shutter). To unlock the memory card, slide the switch to the “write” position.

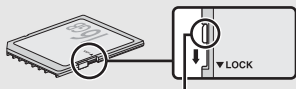

*Write-protect switch*

## ✔ No Memory Card

If no memory card is inserted, the control panel and viewfinder will show [- E -]. If the camera is turned off with a charged battery and no memory card inserted, [- E -] will be displayed in the control panel.

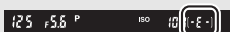
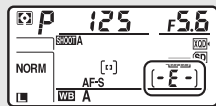

## ■ ■ Removing the Battery and Memory Cards

### Removing the Battery

Turn the camera off and open the battery-chamber cover. Press the battery latch in the direction shown by the arrow to release the battery and then remove the battery by hand.

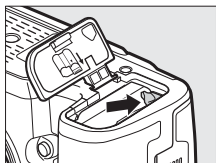

### Removing Memory Cards

After confirming that the memory card access lamp is off, turn the camera off and open the memory card slot cover. Press the card in and then release it (①). The memory card can then be removed by hand (②).

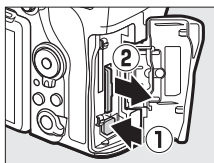

*XQD memory cards*

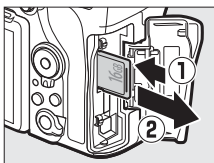

*SD memory cards*

## **Attach a Lens**

Be careful to prevent dust from entering the camera when the lens or body cap is removed. The lens generally used in this manual for illustrative purposes is an AF-S NIKKOR 50mm f/1.4G.

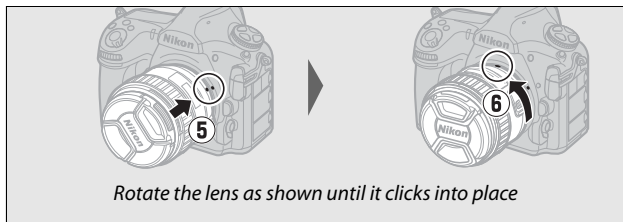
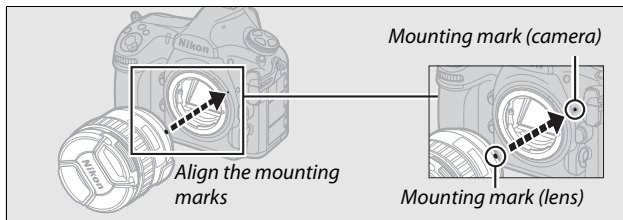
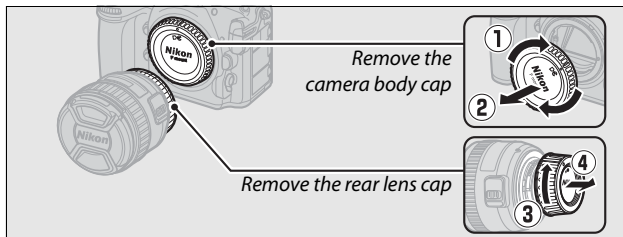

Be sure to remove the lens cap before taking pictures.

### Detaching the Lens

Be sure the camera is off when removing or exchanging lenses. To remove the lens, press and hold the lens release button (1) while turning the lens clockwise (2). After removing the lens, replace the lens caps and camera body cap.

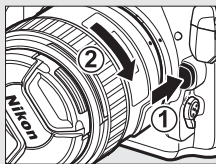

### CPU Lenses with Aperture Rings

In the case of CPU lenses equipped with an aperture ring (☐ 284), lock aperture at the minimum setting (highest f-number).

## Basic Setup

The language option in the setup menu is automatically highlighted the first time menus are displayed. Choose a language and set the camera clock.

### 1 Turn the camera on.

Power switch

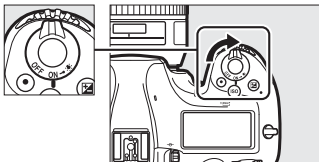

### 2 Select **Language** in the setup menu.

Press the **MENU** button to display the camera menus, then highlight **Language** in the setup menu and press **OK**. For information on using menus, see “Using Camera Menus” (📖 25).

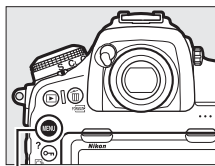

MENU button

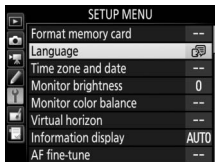



### 🔗 Connecting to Smart Devices with SnapBridge

Install the SnapBridge app to your smart device to download pictures from the camera or control the camera remotely. For more information, see the supplied *SnapBridge Connection Guide (for D-SLR Cameras)*.



### 3 Select a language.

Press  or  to highlight the desired language and press .





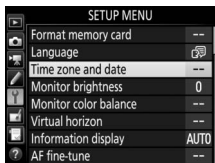

### 4 Select Time zone and date.

Select **Time zone and date** and press .



### 5 Set time zone.

Select **Time zone** and press . Press  or  to highlight the local time zone (the **UTC** field shows the difference between the selected time zone and Coordinated Universal Time, or UTC, in hours) and press .

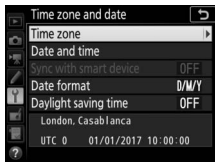

- 
- 6 Turn daylight saving time on or off.**  
Select **Daylight saving time** and press  $\blacktriangleright$ . Daylight saving time is off by default; if daylight saving time is in effect in the local time zone, press  $\blacktriangle$  to highlight **On** and press  $\text{OK}$ .

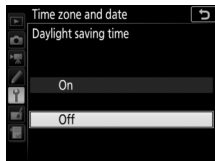

- 
- 7 Set the date and time.**  
Select **Date and time** and press  $\blacktriangleright$ . Press  $\blacktriangle$  or  $\blacktriangleright$  to select an item,  $\blacktriangle$  or  $\blacktriangleright$  to change. Press  $\text{OK}$  when the clock is set to the current date and time (note that the camera uses a 24-hour clock).

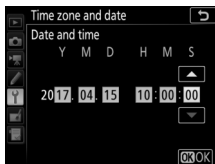

- 
- 8 Set date format.**  
Select **Date format** and press  $\blacktriangleright$ . Press  $\blacktriangle$  or  $\blacktriangleright$  to choose the order in which the year, month, and day will be displayed and press  $\text{OK}$ .

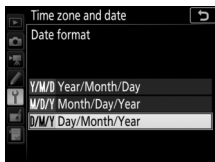

- 
- 9 Exit to shooting mode.**  
Press the shutter-release button halfway to exit to shooting mode.



# Tutorial

## Camera Menu: An Overview

Most shooting, playback, and setup options can be accessed from the camera menus. To view the menus, press the **MENU** button.

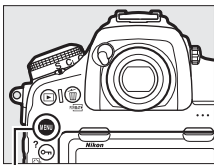

MENU button

### Tabs

Choose from the following menus:

- : **Playback** (📖 248)
- : **Photo Shooting** (📖 250)
- : **Movie Shooting** (📖 256)
- : **Custom Settings** (📖 260)
- : **Setup** (📖 271)
- : **Retouch** (📖 278)
- : **MY MENU** or **RECENT SETTINGS**  
(defaults to **MY MENU**; 📖 280)

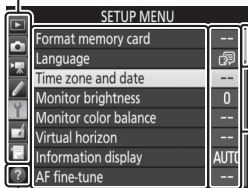

Slider shows position in current menu.

Current settings are shown by icons.

### Menu options

Options in current menu.

**Help icon** (📖 25)



## Using Camera Menus

### ■ Menu Controls

You can navigate the menus via the touch screen or using the multi selector and **OK** button.

#### Multi selector

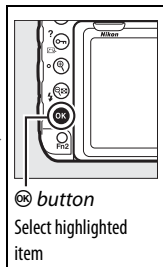
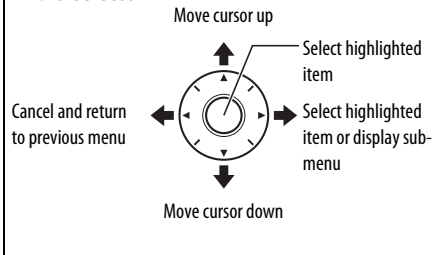

### ■ The ? (Help) Icon

If a ? icon is displayed at the bottom left corner of the monitor, a description of the currently selected option or menu can be displayed by pressing the **?** (INFO/? ) button. Press **?** or **?** to scroll through the display. Press **?** (INFO/? ) again to return to the menus.

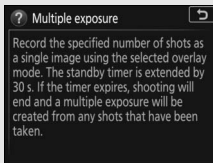
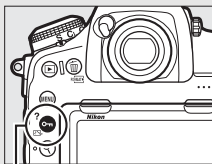

## ■ Navigating the Menus

Follow the steps below to navigate the menus.

### 1 Display the menus.

Press the **MENU** button to display the menus.

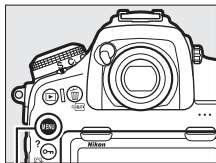

MENU button

### 2 Highlight the icon for the current menu.

Press  to highlight the icon for the current menu.

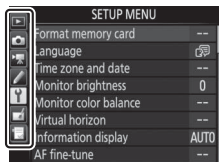

### 3 Select a menu.

Press  or  to select the desired menu.



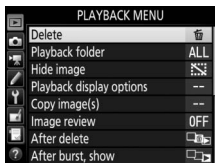

### 4 Position the cursor in the selected menu.

Press  to position the cursor in the selected menu.



## 5 Highlight a menu item.

Press  or  to highlight a menu item.

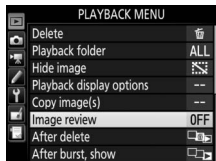



## 6 Display options.

Press  to display options for the selected menu item.



## 7 Highlight an option.

Press  or  to highlight an option.

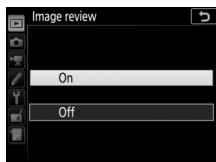

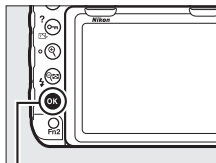

## 8 Select the highlighted item.

Press  to select the highlighted item.  
To exit without making a selection, press the MENU button.



 button

Note the following points:

- Menu items that are displayed in gray are not currently available.
- While pressing  or the center of the multi selector generally has the same effect as pressing , there are some items for which selection can only be made by pressing .
- To exit the menus and return to shooting mode, press the shutter-release button halfway.

## ■ ■ Using the Touch Screen

You can also navigate the menus using the following touch screen operations.

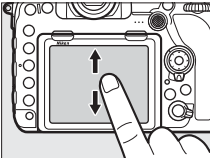
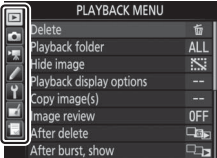
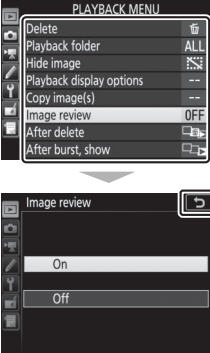
<b>Scroll</b>	Slide up or down to scroll.	
<b>Choose a menu</b>	Tap a menu icon to choose a menu.	
<b>Select options/adjust settings</b>	Tap menu items to display options and tap icons or sliders to change. To exit without changing settings, tap ↶.	

## Basic Photography and Playback

### The Battery Level and Number of Exposures Remaining

Before taking photographs, check the battery level and number of exposures remaining as described below.

#### ■ **Battery Level**

The battery level is shown in the control panel and viewfinder.

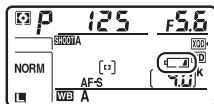

*Control panel*



*Viewfinder*

Icon		Description	
Control panel	Viewfinder		
	—	Battery fully charged.	
	—		
	—		Battery partially discharged.
	—		
		Low battery. Charge battery or ready spare battery.	
 (flashes)	 (flashes)	Shutter release disabled. Charge or exchange battery.	

#### ■ **Camera Off Display**

If the camera is turned off with a battery and memory card inserted, the memory card icon and number of exposures remaining will be displayed (some memory cards may in rare cases only display this information when the camera is on).

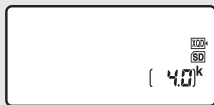

*Control panel*

## ■ ■ Number of Exposures Remaining

The camera has two memory card slots: one for XQD cards and the other for SD cards. When two cards are inserted, the role played by each is determined by the options selected for **Primary slot selection** and **Secondary slot function**; when **Secondary slot function** is set to the default value of **Overflow** (☞ 93), the card in the secondary slot will only be used when the card in the primary slot is full.

The control panel display shows what cards are currently inserted (the example here shows the display when cards are inserted in both slots). If an error occurs (for example, if the memory card is full or the card in the SD slot is locked), the icon for the affected card will flash (☞ 330).

The control panel and viewfinder show the number of photographs that can be taken at current settings (values over 1000 are rounded down to the nearest hundred; e.g., values between 4000 and 4099 are shown as 4.0 k).

SD card slot

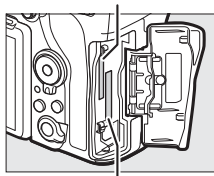

XQD card slot

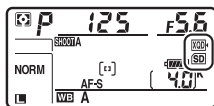

Control panel

Number of exposures remaining

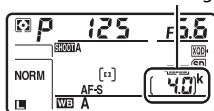

Control panel



Viewfinder

# “Point-and-Shoot” Photography

---

## **1** Ready the Camera.

When framing photographs in the viewfinder, hold the handgrip in your right hand and cradle the camera body or lens with your left.



When framing photographs in portrait (tall) orientation, hold the camera as shown.

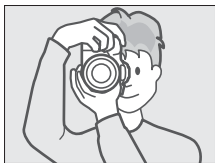

## **2** Frame the photograph.

At default settings, the camera will focus on the subject in the center focus point. Frame a photograph in the viewfinder with the main subject in the center focus point.

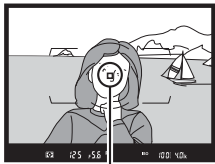

*Focus point*



### 3 Press the shutter-release button halfway.

Press the shutter-release button halfway to focus. The in-focus indicator (●) will appear in the viewfinder when the focus operation is complete.



Focus indicator

Viewfinder display	Description
●	Subject in focus.
▶	Focus point is between camera and subject.
◀	Focus point is behind subject.
▶ ◀ (flashes)	Camera unable to focus on subject in focus point using autofocus (📖 110).

### 4 Shoot.

Smoothly press the shutter-release button the rest of the way down to take the photograph. The memory card access lamp will light and the photograph will be displayed in the monitor

for a few seconds. *Do not eject the memory card or remove or disconnect the power source until the lamp has gone out and recording is complete.*

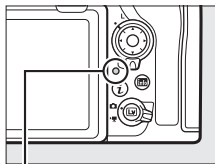

Memory card access lamp

### The Standby Timer (Viewfinder Photography)

The viewfinder and some control panel displays will turn off if no operations are performed for about six seconds, reducing the drain on the battery. Press the shutter-release button halfway to reactivate the displays.

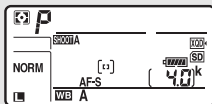
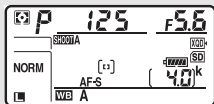

 125 F5.6 P ISO 100 4.0k

*Exposure meters on*

*Exposure meters off*

The length of time before the standby timer expires automatically can be adjusted using Custom Setting c2 (**Standby timer**,  263).

### The Multi Selector

The multi selector can be used to select the focus point while the exposure meters are on ( 105).

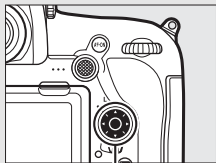

*Multi selector*

## Viewing Photographs

### 1 Press the button.

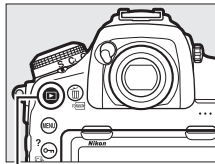

A photograph will be displayed in the monitor. The memory card containing the picture currently displayed is shown by an icon.



 button



### 2 View additional pictures.

Additional pictures can be displayed by pressing  or  or flicking a finger left or right over the display (□ 226).



To end playback and return to shooting mode, press the shutter-release button halfway.

#### Image Review

When **On** is selected for **Image review** in the playback menu (□ 249), photographs are automatically displayed in the monitor after shooting.

#### See Also

For information on choosing a memory card for playback, see “Playback Controls” (□ 224).

## ■ Deleting Unwanted Photographs



To delete the photograph currently displayed in the monitor, press the  (FORMAT) button. *Note that photographs cannot be recovered once deleted.*

### 1 Display the photograph.

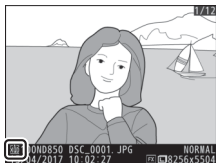
Display the photograph you wish to delete as described in “Viewing Photographs” (📖 35). The location of the current image is shown by an icon at the bottom left corner of the display.



### 2 Delete the photograph.

Press the  (FORMAT) button. A confirmation dialog will be displayed; press the  (FORMAT) button again to delete the image and return to playback. To exit without deleting the picture, press .

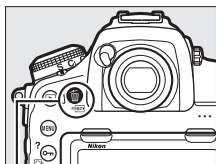

 (FORMAT) button



### Delete

To delete multiple images or to select the memory card from which images will be deleted, use the **Delete** option in the playback menu (📖 246).

# Live View Photography

Follow the steps below to take photographs in live view.

- 1 Rotate the live view selector to  (live view photography).**

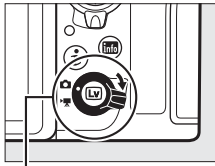

*Live view selector*

- 2 Press the  button.**  
The mirror will be raised and the view through the lens will be displayed in the camera monitor. The subject will no longer be visible in the viewfinder.

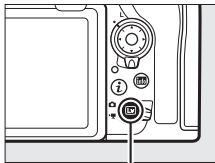

*Lv button*

- 3 Position the focus point.**  
Position the focus point over your subject as described in "Choosing an AF-Area Mode" (□ 42).

## 4 Focus.

Press the shutter-release button halfway to focus.



The focus point will flash green and the shutter release will be disabled while the camera focuses. If the camera is able to focus, the focus point will be displayed in green; if the camera is unable to focus, the focus point will flash red (note that pictures can be taken even when the focus point flashes red; check focus in the monitor before shooting). Exposure can be locked by pressing the center of the sub-selector (📖 137); focus locks while the shutter-release button is pressed halfway.

### ☑ Using Autofocus in Live View

Use an AF-S or AF-P lens. The desired results may not be achieved with other lenses or teleconverters. Note that in live view, autofocus is slower and the monitor may brighten or darken while the camera focuses. The focus point may sometimes be displayed in green when the camera is unable to focus. The camera may be unable to focus in the following situations:

- The subject contains lines parallel to the long edge of the frame
- The subject lacks contrast
- The subject in the focus point contains areas of sharply contrasting brightness, or includes spot lighting or a neon sign or other light source that changes in brightness
- Flicker or banding appears under fluorescent, mercury-vapor, sodium-vapor, or similar lighting
- A cross (star) filter or other special filter is used
- The subject appears smaller than the focus point
- The subject is dominated by regular geometric patterns (e.g., blinds or a row of windows in a skyscraper)
- The subject is moving

## 5 Take the picture.

Press the shutter-release button the rest of the way down to shoot. The monitor will turn off.







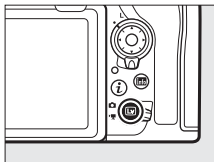

## 6 Exit live view.

Press the  button to exit live view.





### Exposure Preview

During live view, you can press  to preview the effects of shutter speed, aperture, and ISO sensitivity on exposure. Exposure can be adjusted by  $\pm 5$  EV ( 139), although only values between  $-3$  and  $+3$  EV are reflected in the preview display. Note that the preview may not accurately reflect the final results when flash lighting is used, Active D-Lighting ( 180), HDR (high dynamic range;  182), or bracketing is in effect, **A** (auto) is selected for the Picture Control **Contrast** parameter ( 178), or  $\times 25\sigma$  is selected for shutter speed. If the subject is very bright or very dark, the exposure indicators will flash to warn that the preview may not accurately reflect exposure. Exposure preview is not available when   or  $--$  is selected for shutter speed.



### Live View Zoom Preview

Press the  button to magnify the view in the monitor up to a maximum of about 16x. A navigation window will appear in a gray frame at the bottom right corner of the display. Use the multi selector to scroll to areas of the frame not visible in the monitor, or press  (⚡) to zoom out.

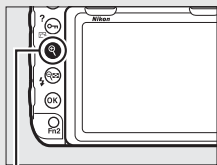









 button



Navigation window

### See Also

For information on:

- Choosing how long the monitor remains on during live view, see  > Custom Setting c4 (**Monitor off delay**,  264).
- Choosing the roles played by the movie-record button and command dials and by the center of the multi selector, see  > Custom Settings f1 (**Custom control assignment**) > **Movie record button** +  ( 268) and f2 (**Multi selector center button**,  268).
- Preventing unintended operation of the  button, see  > Custom Setting f8 (**Live view button options**,  270).



## Autofocus

To take pictures using autofocus, rotate the focus-mode selector to **AF**.

Focus-mode selector

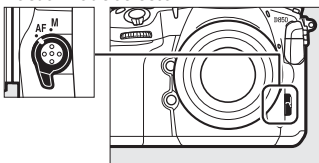

## Choosing a Focus Mode

The following autofocus modes are available in live view:

Mode	Description
AF-S	<b>Single-servo AF:</b> For stationary subjects. Focus locks when shutter-release button is pressed halfway. You can also focus by touching your subject in the monitor, in which case focus locks until you lift your finger from the display to take the photograph.
AF-F	<b>Full-time-servo AF:</b> For moving subjects. Camera focuses continuously until shutter-release button is pressed. Focus locks when shutter-release button is pressed halfway. You can also focus by touching your subject in the monitor, in which case focus locks until you lift your finger from the display to take the photograph.

To choose an autofocus mode, press the AF-mode button and rotate the main command dial until the desired mode is displayed in the monitor.

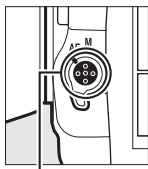

AF-mode button

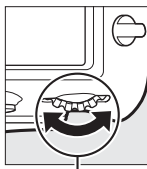





Main command dial



## Choosing an AF-Area Mode

The following AF-area modes can be selected in live view:

Mode	Description
	<b>Face-priority AF:</b> Use for portraits. The camera automatically detects and focuses on portrait subjects; the selected subject is indicated by a double yellow border (if multiple faces are detected, the camera will focus on the closest subject; to choose a different subject, use the multi selector). If the camera can no longer detect the subject (because, for example, the subject has turned to face away from the camera), the border will no longer be displayed. If you touch the monitor, the camera will focus on the face closest to your finger and take a photograph when you lift your finger from the screen.
	<b>Wide-area AF:</b> Use for hand-held shots of landscapes and other non-portrait subjects. Use the multi selector or touch controls to move the focus point anywhere in the frame, or press the center of the multi selector to position the focus point in the center of the frame.
	<b>Normal-area AF:</b> Focus on a selected spot in the frame. Use the multi selector or touch controls to move the focus point anywhere in the frame, or press the center of the multi selector to position the focus point in the center of the frame. A tripod is recommended.
	<b>Pinpoint AF:</b> As for normal-area AF, except that a smaller focus point is used for pinpoint focus on smaller targets.

Mode	Description
	<p><b>Subject-tracking AF:</b> Position the focus point over your subject and press the center of the multi selector. The focus point will track the selected subject as it moves through the frame. To end tracking, press the center of the multi selector again.</p> <p>Alternatively, you can start tracking by touching your subject in the monitor; to end tracking and take a photograph, lift your finger from the screen. If tracking is already in progress, touching the monitor anywhere will cause the camera to focus on the current subject, and a photo will be taken when you lift your finger from the screen. Note that the camera may be unable to track subjects if they move quickly, leave the frame or are obscured by other objects, change visibly in size, color, or brightness, or are too small, too large, too bright, too dark, or similar in color or brightness to the background.</p>

To choose an AF-area mode, press the AF-mode button and rotate the sub-command dial until the desired mode is displayed in the monitor.

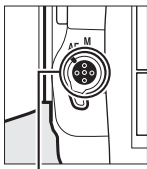

*AF-mode button*

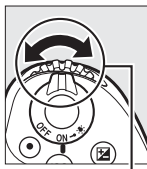

*Sub-command dial*



## Manual Focus

To focus in manual focus mode (📖 111), rotate the lens focus ring until the subject is in focus. To magnify the view in the monitor for precise focus, press the  button (📖 40).

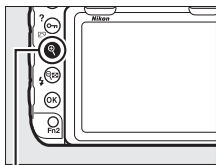
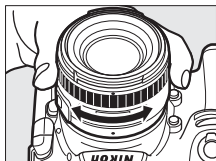

 button

You can also enable focus peaking, which uses colored outlines to indicate objects that are in focus. To enable focus peaking, press the  button and select an option other than **Off** for **Peaking level** (📖 45).

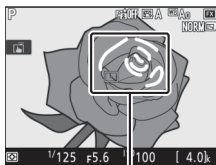

*Area in focus*

### Previewing Focus During Live View

To temporarily select maximum aperture for an improved focus preview during live view, press the **Pv** button; the maximum aperture indicator (📖 54) will be displayed. To return aperture to its original value, press the button again or focus using autofocus. If the shutter-release button is pressed all the way down to take a picture during focus preview, aperture will return to the original value before the photo is taken.

## Using the *i* Button

The options listed below can be accessed by pressing the *i* button during live view photography. Use the touch screen or navigate the menu using the multi selector and OK button, pressing ▲ or ▼ to highlight items, ⏏ to view options, and ⏏ to select the highlighted option and return to the *i*-button menu. Press the *i* button again to exit to the shooting display.

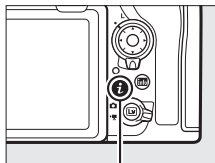

*i* button



Option	Description
<b>Choose image area</b>	Choose an image area for live view photography (□ 83).
<b>Active D-Lighting</b>	Adjust Active D-Lighting (□ 180).
<b>Electronic front-curtain shutter</b>	Enable or disable the electronic front-curtain shutter for mirror-up photography (□ 265).
<b>Monitor brightness</b>	Press ▲ or ▼ to adjust monitor brightness for live view (note that this affects live view only and has no effect on photographs or movies or on the brightness of the monitor for menus or playback; to adjust the brightness of the monitor for menus and playback, use the <b>Monitor brightness</b> option in the setup menu; □ 271).

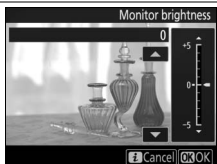

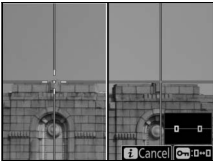
Option	Description
<p><b>Photo live view display WB</b></p>	<p>During live view photography, the white balance (hue) of the monitor can be set to a value different from that used for photographs (□ 156). This can be effective if the lighting under which shots are framed is different from that used when the photographs are taken, as is sometimes the case when a flash or preset manual white balance is used. Adjusting the photo live view display white balance to produce a similar effect to that used for the actual photographs makes it easier to picture the results. To use the same white balance for both the view in the monitor and the photograph, select <b>None</b>. Monitor white balance is reset when the camera is turned off, but the last value used can be selected by pressing the <b>[Lv]</b> button while pressing and holding the <b>WB</b> button.</p> 
<p><b>Split-screen display zoom</b></p>	<p>View two separate areas of the frame side-by-side (□ 48). This option can be used, for example, to align buildings with the horizon.</p> 
<p><b>Silent live view photography</b></p>	<p>Eliminate the sound made by the shutter when photos are taken (□ 49).</p>







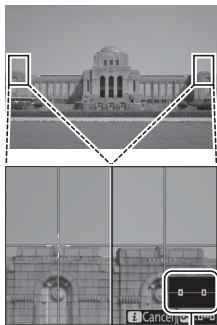

Option	Description
<p><b>Peaking level</b></p>	<p>Objects that are in focus are indicated by colored outlines, including during focus zoom (□ 40). Choose from <b>3 (high sensitivity)</b>, <b>2 (standard)</b>, <b>1 (low sensitivity)</b>, and <b>Off</b>; the higher the setting, the greater the depth shown as being in focus. The peaking color can be changed using Custom Setting d8 (<b>Peaking highlight color</b>, □ 265).</p> <div data-bbox="650 99 930 311" data-label="Image"> </div> <div data-bbox="650 372 930 582" data-label="Image"> </div>
<p><b>Negative digitizer</b></p>	<p>Create positives from color or black-and-white film negatives (□ 52).</p>

## **Split-Screen Display Zoom**

Selecting **Split-screen display zoom** in the live view photography **i** button menu splits the display into two boxes showing separate areas of the frame side-by-side at a high zoom ratio. The positions of the magnified areas are shown in the navigation window.



*Navigation window*

Use the  and  buttons to zoom in and out, or use the  (/?) button to select a box and press  or  to scroll the selected area left or right. Pressing  or  scrolls both areas up or down simultaneously. To focus on the subject at the center of the selected area, press the shutter-release button halfway. To exit the split-screen display, press the **i** button.

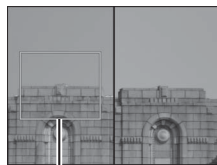

*Area in focus*



## Silent Live View Photography

To eliminate shutter sounds during live view photography, press the **i** button and select **On (Mode 1)** or **On (Mode 2)** for **Silent live view photography**.

Option	Description
<b>On (Mode 1)</b>	Reduce vibrations caused by the shutter when shooting landscapes and other static subjects. Use of a tripod is recommended. The maximum frame rate for release mode <b>CH</b> is approximately 6 fps. In <b>CL</b> mode, the user can choose from frame rates of 1–6 fps, but the maximum rate will not exceed approximately 3 fps regardless of the option selected. ISO sensitivity (☐ 119) can be set to values of from Lo 1 to 25600.
<b>On (Mode 2)</b>	Photographs can be taken at a higher rate than when <b>On (Mode 1)</b> is selected. In release modes <b>S</b> , <b>Q</b> , <b>☺</b> , and <b>MUP</b> , one photograph will be taken each time the shutter-release button is pressed, while in continuous modes photos will be taken at approximately 15 fps ( <b>CL</b> and <b>QC</b> ) or 30 fps ( <b>CH</b> ) for a maximum of 3 seconds. Image area is fixed at <b>DX (24×16)</b> , image size at 3600 × 2400, and image quality at <b>JPEG normal★</b> .
<b>Off</b>	Silent live view photography disabled.

### **Silent Live View Photography**

Multiple exposure photography (☐ 254) and long-exposure noise reduction are disabled (☐ 253) and the flash cannot be used. In continuous release modes, focus and exposure are fixed at the values for the first shot in each series. Flicker or banding may be visible in the monitor and in photographs under fluorescent, mercury vapor, or sodium lamps (for information on reducing flicker and banding, see the section on the movie shooting menu **Flicker reduction** option, ☐ 254), while subjects in motion may appear distorted, particularly if the camera is panned horizontally or an object moves horizontally at high speed through the frame. Jagged edges, color fringing, moiré, and bright spots may also appear. Bright regions or bands may appear in scenes lit by flashing signs and other intermittent light sources or if the subject is briefly illuminated by a strobe or other bright, momentary light source.

The amount of time you can continue shooting is shown in place of the number of exposures remaining.

Silent live view photography can also be enabled or disabled using the **Silent live view photography** option in the photo shooting menu (☐ 255).

### **Camera Sounds**

The sound of the camera focusing may be audible, as may the sound of the aperture mechanism when you adjust aperture in mode **A** or **M** or take pictures in mode **P** or **S**.

### **Custom Setting d11**

If **On** is selected for Custom Setting d11 (**Live view in continuous mode**, ☐ 266) when **On (Mode 1)** is chosen for **Silent live view photography**, the monitor will briefly go dark when the shutter is released and then turn back on to display the picture. When **On (Mode 2)** is selected, pictures will not be displayed as they are taken; instead, a  icon will appear in the monitor when a picture is taken (during burst photography, the icon will flash).

## 🔍 “On (Mode 2)”

The following exposure settings can be adjusted when **On (Mode 2)** is selected:

	Aperture	Shutter speed	ISO sensitivity <sup>3</sup>
<b>P, S</b> <sup>1</sup>	—	—	—
<b>A</b>	✓	—	—
<b>M</b>	✓	✓ <sup>2</sup>	✓

- 1 Exposure for mode **S** is equivalent to mode **P**.
- 2 Choose from speeds of from  $\frac{1}{50}$  s to  $\frac{1}{8000}$  s.
- 3 In mode **M**, ISO sensitivity can be set manually to values of from Lo 1 to 25600 or adjusted automatically by the camera. In other exposure modes, ISO sensitivity is adjusted automatically by the camera.

Exposure compensation can be used to alter exposure by up to  $\pm 3$  EV. Exposure can be previewed in the monitor. Pressing **OK** will display an exposure indicator (☐ 132) showing the difference between the selected and metered exposure values; to hide the indicator, press **OK** again.

**On (Mode 2)** cannot be combined with some camera features, including flexible program (☐ 128), bracketing (☐ 142), Active D-Lighting (☐ 180), HDR (high dynamic range; ☐ 182), vignette control (☐ 253), auto distortion control (☐ 253), exposure delay mode (☐ 264), and the **Clarity** Picture Control parameter (☐ 178). If **RAW primary - JPEG secondary** is selected for **Secondary slot function** in the photo shooting menu, JPEG images will be recorded to the cards in both slots.

## 🔍 “On (Mode 2)” and Photo Info

The photo info for pictures taken with **On (Mode 2)** selected for **Silent live view photography** and white balance set to **AUTO** (auto) does not include color temperature (☐ 234).

## Negative Digitizer

To record positives of copies of film negatives, press the **i** button and select **Color negatives** or **Monochrome negatives** for **Negative digitizer**.

### **1** Position the negatives in front of a featureless white or gray background.

We recommend using an AF-S Micro NIKKOR 60mm f/2.8G ED or other micro lens and either natural light or an artificial light source with a high  $R_a$  (color rendering index), such as a light box or a high-CRI fluorescent lamp.

### **2** In live view, press the **i** button, highlight **Negative digitizer**, and press **OK**.

The colors in the display will be reversed.



### **3** Choose the film type. Highlight **Color negatives** or **Monochrome negatives** and press **OK**.

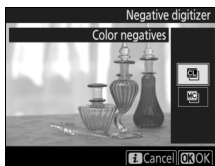

### **4** Compose the shot to capture a frame of the film negative.

## 5 Adjust exposure.

Press **OK** to display brightness adjustment options and press **▲** or **▼** to adjust exposure. To view your subject at a higher magnification, press **Q** (p. 40). Press **OK** to proceed.

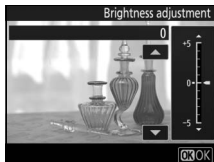

## 6 Take the photograph.

Press the shutter-release button all the way down to take the photograph and save it in JPEG format.

### Negative Digitizer

No options are available for correcting dust, scratches, or uneven colors due to faded film. Photos are saved in JPEG format regardless of the option selected for image quality; photos taken with a JPEG option selected will be saved at the chosen setting, while photos taken with **NEF (RAW)** or **TIFF (RGB)** selected will be saved in **JPEG fine★** format. Some menu items and features, including bracketing and focus shift, are unavailable, and optional flash units cannot be used. Exposure mode is set to **A** and cannot be changed.

## The Live View Display

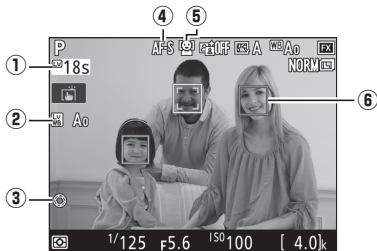

Item	Description
① <b>Time remaining</b>	The amount of time remaining before live view ends automatically. Displayed if shooting will end in 30 s or less.
② <b>Photo live view display white balance indicator</b>	Monitor hue (photo live view display white balance). Can be adjusted using <b>Photo live view display WB</b> in the <b>i</b> -button menu (□ 45).
③ <b>Maximum aperture indicator</b>	Displayed when the <b>Pv</b> button is pressed to select maximum aperture (□ 44).
④ <b>Autofocus mode</b>	The current autofocus mode (□ 41).
⑤ <b>AF-area mode</b>	The current AF-area mode (□ 42).
⑥ <b>Focus point</b>	The current focus point. The display varies with the option selected for AF-area mode.

### The Count Down Display

A count down will be displayed 30 s before live view ends automatically (the timer turns red if live view is about to end to protect the internal circuits or, if an option other than **No limit** is selected for Custom Setting c4—**Monitor off delay > Live view**; □ 264—5 s before the monitor is due to turn off automatically). Depending on shooting conditions, the timer may appear immediately when live view is selected.

## The Information Display

To hide or display indicators in the monitor, press the **Info** button. The histogram is only displayed in the exposure preview (📖 39) or when **On (Mode 2)** is selected for **Silent live view photography** (📖 49). The virtual horizon and histogram displays are not available with the negative digitizer.

*Virtual horizon*  
(📖 272)



*Information on*



*Information off*

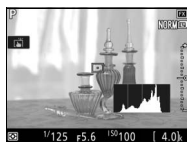

*Histogram*

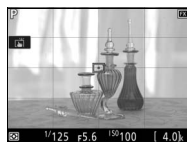

*Framing guides*

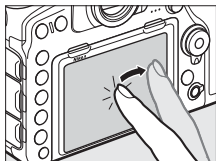

## Touch Photography (Touch Shutter)

Touch the monitor to focus and lift your finger to take the photograph.

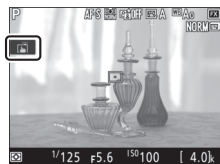

Tap the icon shown in the illustration to choose the operation performed by tapping the monitor in shooting mode. Choose from the following options:



Option	Description
 <b>(Touch shutter/AF: On)</b>	Touch the monitor to position the focus point and focus (autofocus only; the touch shutter cannot be used to focus when the focus-mode selector is rotated to M to select manual focus). Focus locks while your finger remains on the monitor; to release the shutter, lift your finger from the screen.
 <b>(Touch AF: On)</b>	As above, except that lifting your finger from the screen does not release the shutter. If subject tracking (42) is active, you can focus on the current subject by tapping the monitor.
 <b>(Touch shutter/AF: Off)</b>	Touch shutter and AF disabled.

For information on touch photography focus, see “Autofocus” (41).



### ✔ Taking Pictures Using Touch Shooting Options

The shutter-release button can be used to focus and take pictures even when the  icon is displayed to show that the touch shutter is enabled. Use the shutter-release button to take photographs in continuous shooting mode (☐ 113) and during movie recording. Touch shooting options can be used only to take pictures one at a time in continuous shooting mode and cannot be used to take photographs during movie recording.

The touch screen cannot be used to position the focus point when the focus selector lock is in the L (lock) position (☐ 105), but it can still be used to select the subject when face-priority AF is selected for AF-area mode (☐ 42).

In self-timer mode (☐ 116), focus locks on the selected subject when you touch the monitor and the timer starts when you lift your finger from the screen. At default settings, the shutter is released about 10 s after the timer starts; the delay and number of shots can be changed using Custom Setting c3 (**Self-timer**, ☐ 264). If the option selected for **Number of shots** is greater than 1, the camera will automatically take pictures one after the other until the selected number of shots is recorded.

### ✔ Shooting in Live View

To prevent light entering via the viewfinder from interfering with photographs or exposure, close the viewfinder eyepiece shutter (☐ 116).

Although they will not appear in the final picture, jagged edges, color fringing, moiré, and bright spots may appear in the monitor, while bright regions or bands may appear in some areas with flashing signs and other intermittent light sources or if the subject is briefly illuminated by a strobe or other bright, momentary light source. In addition, distortion may occur with moving subjects, particularly if the camera is panned horizontally or an object moves horizontally at high speed through the frame. Flicker and banding visible in the monitor under fluorescent, mercury vapor, or sodium lamps can be reduced using the **Flicker reduction** option in the movie shooting menu (☐ 258), although they may still be visible in the final photograph at some shutter speeds. When shooting in live view, avoid pointing the camera at the sun or other strong light sources. Failure to observe this precaution could result in damage to the camera's internal circuitry.

Regardless of the option selected for Custom Setting c2 (**Standby timer**, ☐ 263), the standby timer will not expire during shooting.

### ✔ Beeps During Live View

A beep may sound if you adjust aperture or use the live view selector during live view.

# Movies

Read this section for information on recording and viewing movies.

## Recording Movies

Movies can be recorded in live view.

- 1 Rotate the live view selector to  (movie live view).

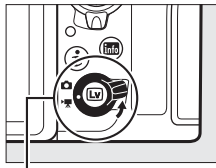

Live view selector

- 2 Press the  button.

The mirror will be raised and the view through the lens will be displayed in the camera monitor, modified for the effects of exposure. The subject will no longer be visible in the viewfinder.

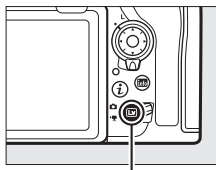

L.V. button

### The icon

A  icon ( 71) indicates that movies cannot be recorded.

### White Balance

White balance can be set at any time by pressing the **WB** button and rotating a command dial ( 156).

### 3 Choose a focus mode (📖 41).



### 4 Choose an AF-area mode (📖 42).

#### 🔍 Pinpoint AF

Pinpoint AF is not available in movie mode.



### 5 Focus.

Frame the opening shot and press the **AF-ON** button to focus. Note that the number of subjects that can be detected in face-priority AF drops during movie recording.

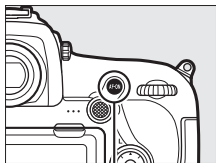

*AF-ON button*

#### 🔍 Focusing

Focus can also be adjusted by pressing the shutter-release button halfway before beginning recording, or you can focus manually as described in “Manual Focus” (📖 44).

## 6 Start recording.

Press the movie-record button to start recording. A recording indicator and the time available are displayed in the monitor. Exposure can be locked by pressing the center of the sub-selector (📖 137) or altered by up to  $\pm 3$  EV using exposure compensation (📖 139); spot metering is not available. In autofocus mode, the camera can be refocused by pressing the **AF-ON** button or by tapping your subject in the monitor.

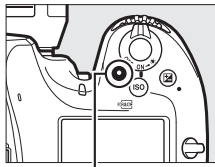

*Movie-record button*

*Recording indicator*



*Time remaining*

### Audio

The camera can record both video and sound; do not cover the microphone on the front of the camera during movie recording. Note that the built-in microphone may record sounds made by the camera or lens during autofocus, vibration reduction, or changes to aperture.

---

## 7 End recording.

Press the movie-record button again to end recording. Recording will end automatically when the maximum length is reached, or the memory card is full (note that depending on memory card write speed, shooting may end before the maximum length is reached).

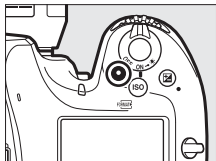

---

## 8 Exit live view.

Press the  button to exit live view.

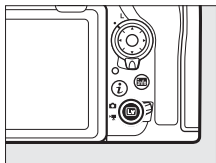

## Exposure Mode

The following exposure settings can be adjusted in movie mode:

	Aperture	Shutter speed	ISO sensitivity
<b>P, S</b> <sup>1</sup>	—	—	— <sup>2,3</sup>
<b>A</b>	✓	—	— <sup>2,3</sup>
<b>M</b>	✓	✓	✓ <sup>3,4</sup>

- 1 Exposure for mode **S** is equivalent to mode **P**.
- 2 The upper limit for ISO sensitivity can be selected using the **ISO sensitivity settings > Maximum sensitivity** option in the movie shooting menu (□ 257).
- 3 Regardless of the option chosen for **ISO sensitivity settings > Maximum sensitivity** or for **ISO sensitivity (mode M)**, the upper limit when **On** is selected for **Electronic VR** in the movie shooting menu is ISO 25600.
- 4 If **On** is selected for **ISO sensitivity settings > Auto ISO control (mode M)** in the movie shooting menu, the upper limit for ISO sensitivity can be selected using the **Maximum sensitivity** option.

In exposure mode **M**, shutter speed can be set to values between  $\frac{1}{25}$  s and  $\frac{1}{8000}$  s (the slowest available shutter speed varies with the frame rate; □ 69). In other exposure modes, shutter speed is adjusted automatically. If the subject is over- or under-exposed in mode **P** or **S**, end live view and start live view again or select exposure **A** and adjust aperture.

## Indices





If **Index marking** is assigned to a control using Custom Setting g1 (**Custom control assignment**, [□ 270](#)), you can press the selected control during recording to add indices that can be used to locate frames during editing and playback ([□ 76](#)). Up to 20 indices can be added to each movie.



*Index*

### See Also

For information on:

- Choosing the role played by the center of the multi selector, see  > Custom Setting f2 (**Multi selector center button**; [□ 268](#)).
- Choosing the roles of the **Fn1**, **Fn2**, and **Pv** buttons and the center of the sub-selector, see  > Custom Setting g1 (**Custom control assignment**; [□ 270](#)).
- Choosing whether the shutter-release button can be used to start live view or to start and end movie recording, see  > Custom Setting g1 (**Custom control assignment**) > **Shutter-release button** ([□ 270](#)).
- Preventing unintended operation of the **Lv** button, see  > Custom Setting f8 (**Live view button options**; [□ 270](#)).



## Using the *i* Button

The options listed below can be accessed by pressing the *i* button in movie mode. Use the touch screen or navigate the menu using the multi selector and **OK** button, pressing **▲** or **▼** to highlight items, **◂** to view options, and **⊙** to select the highlighted option and return to the *i*-button menu. Press the *i* button again to exit to the shooting display.

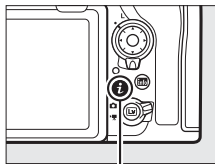

*i* button

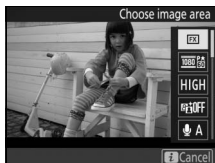

Option	Description
<b>Choose image area</b>	Choose image area for movies (☐ 68).
<b>Frame size/frame rate</b>	Select a frame size and rate (☐ 69).
<b>Movie quality</b>	Choose movie quality (☐ 69).
<b>Active D-Lighting</b>	Adjust Active D-Lighting (☐ 180). Not available when peaking level is displayed or at frame sizes of 1920 × 1080 (slow-mo) and 3840 × 2160 (☐ 69).
<b>Microphone sensitivity</b>	Press <b>▲</b> or <b>▼</b> to adjust microphone sensitivity (☐ 258). Both the built-in and external microphones (☐ 296) are affected.
<b>Attenuator</b>	Reduce microphone gain and prevent audio distortion when recording movies in loud environments.
<b>Frequency response</b>	Control the frequency response of the built-in or external microphones (☐ 259).

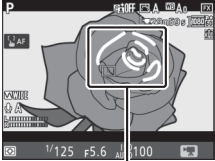
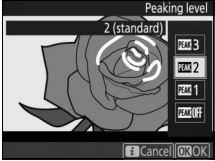

Option	Description
<b>Wind noise reduction</b>	Enable or disable wind noise reduction using the built-in microphone's low-cut filter (☞ 259).
<b>Destination</b>	When two memory cards are inserted, you can choose the card to which movies are recorded (☞ 256).
<b>Monitor brightness</b>	Press ☺ or ☹ to adjust monitor brightness (note that this affects live view only and has no effect on photographs or movies or on the brightness of the monitor for menus or playback; ☞ 45).
<b>Multi-selector power aperture</b>	Select <b>Enable</b> to enable power aperture. Press ☺ to widen the aperture, ☹ to narrow the aperture.
<b>Multi selector exposure comp.</b>	Selecting <b>Enable</b> allows exposure compensation to be set by pressing ☺ or ☹.
<b>Highlight display</b>	<p>If <b>Pattern 1</b> or <b>Pattern 2</b> is selected, shading will be used to indicate highlights (bright areas of the frame). The level of brightness needed to trigger the highlight display can be selected using Custom Setting g2 (<b>Highlight brightness</b>, ☞ 270). <b>Peaking level</b> is disabled when highlights are displayed.</p> <div data-bbox="335 794 912 1086" style="text-align: center;"> <p>Highlights</p> <p>Pattern 1                      Pattern 2</p> </div>
<b>Headphone volume</b>	Press ☺ or ☹ to adjust headphone volume.
<b>Electronic VR</b>	Select <b>On</b> to enable electronic vibration reduction in movie mode. Not available at frame sizes of 1920 × 1080 (slow-mo) and 3840 × 2160 (☞ 69). Note that if electronic vibration is on, <b>Peaking level</b> will be disabled, the angle of view will be reduced, and the edges of the frame will be cropped out.

Option	Description
<b>Peaking level</b>	<p>Choose whether objects that are in focus will be indicated by colored outlines while manual focus is in effect.</p>  <p style="text-align: center;"><i>Area in focus</i></p>
	<p>Choose from <b>3 (high sensitivity)</b>, <b>2 (standard)</b>, <b>1 (low sensitivity)</b>, and <b>Off</b>; the higher the setting, the greater the depth shown as being in focus. The peaking color can be changed using Custom Setting d8 (<b>Peaking highlight color</b>, □ 265). Peaking is not available when highlight display is enabled or at frame sizes of 1920 × 1080 (slow-mo) and 3840 × 2160 (□ 69) or when Active D-Lighting (□ 180) or electronic vibration reduction is enabled.</p> 

### **Using an External Microphone**

The optional ME-1 stereo microphone or ME-W1 wireless microphone can be used to record sound for movies (□ 296).

### **Headphones**

Third-party headphones can be used. Note that high sound levels may result in high volume; particular care should be taken when headphones are used.

## Image Area: Choosing a Movie Crop

You can choose an image area using the **Image area > Choose image area** option in the movie shooting menu. Select **FX** to shoot movies in what is referred to as “FX-based movie format”, **DX** to shoot in “DX-based movie format”. The differences between the two are illustrated below.

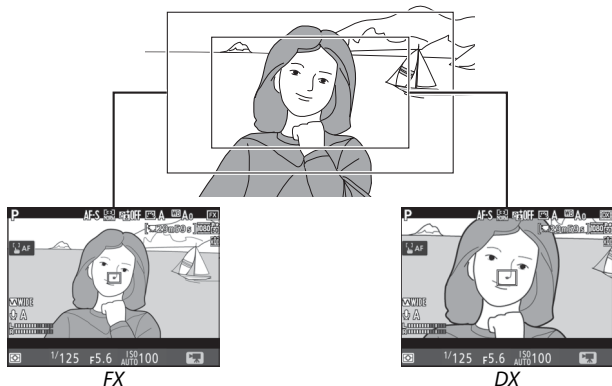

The sizes of the areas recorded are approximately  $35.9 \times 20.2$  mm (FX-based movie format) and  $23.5 \times 13.2$  mm (DX-based movie format). Movies shot with a DX-format lens and **On** selected for **Image area > Auto DX crop** (84) in the movie shooting menu are recorded in DX-based movie format, as are all movies (regardless of the lens used or the option selected for **Image area > Choose image area**) with a frame size of  $1920 \times 1080$  (slow-mo). Enabling electronic vibration reduction by selecting **On** for **Electronic VR** in the **i**-button menu reduces the size of the crop, slightly increasing the apparent focal length.

## Frame Size, Frame Rate, and Movie Quality

The **Frame size/frame rate** option in the movie shooting menu is used to choose the movie frame size (in pixels) and frame rate. You can also choose from two **Movie quality** options: high and normal. Together, these options determine the maximum bit rate, as shown in the following table.

Option <sup>1</sup>	Maximum bit rate (Mbps) (★ high quality/Normal)	Maximum length
$\frac{2160 \text{ P}}{60}$ $\frac{2160 \text{ A}}{60}$ <b>3840 × 2160 (4K UHD); 30p</b> <sup>2</sup>	144	29 min. 59 s <sup>3</sup>
$\frac{2160 \text{ P}}{25}$ $\frac{2160 \text{ A}}{25}$ <b>3840 × 2160 (4K UHD); 25p</b> <sup>2</sup>		
$\frac{2160 \text{ P}}{24}$ $\frac{2160 \text{ A}}{24}$ <b>3840 × 2160 (4K UHD); 24p</b> <sup>2</sup>		
$\frac{1080 \text{ P}}{60}$ $\frac{1080 \text{ P}}{60}$ / $\frac{1080 \text{ P}}{50}$ <b>1920 × 1080; 60p</b>	48/24	
$\frac{1080 \text{ P}}{50}$ $\frac{1080 \text{ P}}{50}$ / $\frac{1080 \text{ P}}{30}$ <b>1920 × 1080; 50p</b>		
$\frac{1080 \text{ P}}{30}$ $\frac{1080 \text{ P}}{30}$ / $\frac{1080 \text{ P}}{25}$ <b>1920 × 1080; 30p</b>	24/12	
$\frac{1080 \text{ P}}{25}$ $\frac{1080 \text{ P}}{25}$ / $\frac{1080 \text{ P}}{24}$ <b>1920 × 1080; 25p</b>		
$\frac{1080 \text{ P}}{24}$ $\frac{1080 \text{ P}}{24}$ / $\frac{720 \text{ P}}{60}$ <b>1920 × 1080; 24p</b>		
$\frac{720 \text{ P}}{60}$ $\frac{720 \text{ P}}{60}$ / $\frac{720 \text{ P}}{50}$ <b>1280 × 720; 60p</b>		
$\frac{720 \text{ P}}{50}$ $\frac{720 \text{ P}}{50}$ / $\frac{720 \text{ P}}{30}$ <b>1280 × 720; 50p</b>		
$\frac{1080 \text{ HA}}{60}$ <b>1920 × 1080; 30p × 4 (slow-mo)</b> <sup>4</sup>	36	Recording: 3 min. Playback: 12 min.
$\frac{1080 \text{ HA}}{25}$ <b>1920 × 1080; 25p × 4 (slow-mo)</b> <sup>4</sup>		
$\frac{1080 \text{ HA}}{24}$ <b>1920 × 1080; 24p × 5 (slow-mo)</b> <sup>4</sup>	29	Recording: 3 min. Playback: 15 min.

1 Actual frame rate is 29.97 fps for values listed as 30p, 23.976 fps for values listed as 24p, and 59.94 fps for values listed as 60p.

2 When this option is selected, movie quality is fixed at “high”.

3 Each movie will be recorded across up to 8 files of up to 4 GB each. The number of files and the length of each file vary with the options selected for **Frame size/frame rate** and **Movie quality**.

4 See “Slow Motion Movies” (□ 70).

## ■ Slow-Motion Movies

To record silent slow-motion movies, select **1920×1080; 30p ×4 (slow-mo)**, **1920×1080; 25p ×4 (slow-mo)**, or **1920×1080; 24p ×5 (slow-mo)** for **Frame size/frame rate** in the movie shooting menu. Movies recorded at 4 or 5 times the rated speed are played back at the rated speed for a slow-motion effect; for example, movies shot with **1920×1080; 30p ×4 (slow-mo)** selected will be recorded at a frame of roughly 120 fps (120p) and play back at approximately 30 fps (30p).

Frame size/frame rate	Frame rate*	
	Recorded at	Plays back at
<b>1920 × 1080; 30p ×4 (slow-mo)</b>	120p	30p
<b>1920 × 1080; 25p ×4 (slow-mo)</b>	100p	25p
<b>1920 × 1080; 24p ×5 (slow-mo)</b>	120p	24p

\* Actual frame rate is 119.88 fps for values listed as 120p, 29.97 fps for values listed as 30p, and 23.976 fps for values listed as 24p.

### Slow-Motion Movies

When a slow-motion option is selected, quality is fixed at “normal” and the image area is fixed at **DX**, regardless of the lens used or the option selected for **Image area > Choose image area** in the movie shooting menu (□ 256). Movies shot with face-priority AF, pinpoint AF, or subject-tracking AF selected for AF-area mode (□ 42) are recorded using wide-area AF.

## The Live View Display

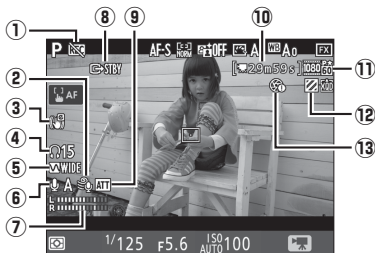

Item	Description
① “No movie” indicator	Indicates that movies cannot be recorded.
② Wind noise reduction	Displayed when wind noise reduction is on (□ 259).
③ Electronic VR indicator	Displayed when electronic vibration reduction is on (□ 259).
④ Headphone volume	Volume of audio output to headphones. Displayed when third-party headphones are connected.
⑤ Frequency response	The current frequency response (□ 259).
⑥ Microphone sensitivity	Microphone sensitivity (□ 258).
⑦ Sound level	Sound level for audio recording. Displayed in red if level is too high; adjust microphone sensitivity accordingly.
⑧ HDMI recording indicator	Displayed if movies are simultaneously being recorded to a device connected via HDMI.
⑨ Attenuator indicator	Displayed when the attenuator is enabled (□ 259).
⑩ Time remaining	The recording time available for movies.
⑪ Movie frame size	The frame size for movie recording (□ 69).
⑫ Highlight display indicator	Displayed when highlight display is on.
⑬ “No power aperture” indicator	Indicates that power aperture is unavailable.

## The Information Display

To hide or display indicators in the monitor, press the **Info** button.

*Virtual horizon*

( 272)



*Information on*



*Information off*



*Histogram*



*Framing guides*

### The Count-Down Display

A count down will be displayed 30 s before live view ends automatically ( 54). Depending on shooting conditions, the timer may appear immediately when movie recording begins. Note that regardless of the amount of recording time available, live view will still end automatically when the timer expires.

### Adjusting Settings During Movie Recording

Headphone volume cannot be adjusted during recording. If an option other than (microphone off) is currently selected, microphone sensitivity can be changed to any setting other than while recording is in progress.





## Taking Photos in Movie Mode

To take photos in movie mode (either in live view or during movie recording), select **Take photos** for Custom Setting g1 (**Custom control assignment**) >



**Shutter-release button** (☞ 270). Photos with an aspect ratio of 16 : 9 can then be taken at any time by pressing the shutter-release button all the way down. If movie recording is in progress, recording will end and the footage recorded to that point will be saved.

Except at a frame size of 3840 × 2160 (☞ 69), photographs are recorded in the format selected for **Image quality** in the photo shooting menu (☞ 88); photos taken at a frame size of 3840 × 2160 are recorded at an image quality of JPEG fine★. For information on image size, see “Image Size” (☞ 74). Note that the exposure for photographs cannot be previewed when the live view selector is rotated to ; mode **P**, **S**, or **A** is recommended but accurate results can be achieved in mode **M** by previewing exposure with the live view selector rotated to .

## Image Size

The size of photos taken in movie mode varies with the image area (☐ 256) and the option selected for **Image size** in the photo shooting menu (☐ 91).

Image area	Image size	Size (pixels)
FX	Large	8256 × 4640
	Medium	6192 × 3480
	Small	4128 × 2320
DX	Large	5408 × 3040
	Medium	4048 × 2272
	Small	2704 × 1520

### Recording Movies

Movies are recorded in the sRGB color space. Flicker, banding, or distortion may be visible in the monitor and in the final movie under fluorescent, mercury vapor, or sodium lamps or with subjects that are in motion, particularly if the camera is panned horizontally or an object moves horizontally at high speed through frame (for information on reducing flicker and banding, see the section on the movie shooting menu **Flicker reduction** option, ☐ 258). Flicker may also appear while power aperture is in use. Jagged edges, color fringing, moiré, and bright spots may also appear. Bright regions or bands may appear in some areas of the frame with flashing signs and other intermittent light sources or if the subject is briefly illuminated by a strobe or other bright, momentary light source. When recording movies, avoid pointing the camera at the sun or other strong light sources. Failure to observe this precaution could result in damage to the camera's internal circuitry. Note that noise (randomly-spaced bright pixels, fog, or lines) and unexpected colors may appear if you zoom in on the view through the lens (☐ 40) in movie mode.



Flash lighting cannot be used.

Recording ends automatically if the lens is removed or the live view selector is rotated to a new setting.

### **Wireless Remote Controllers and Remote Cords**





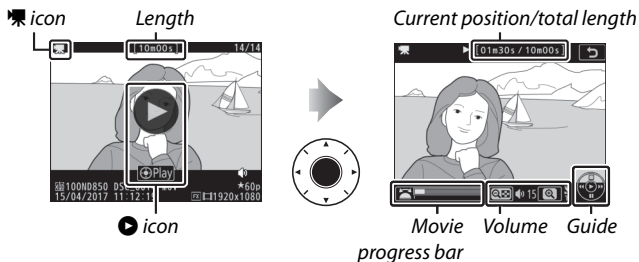

If **Record movies** is selected for Custom Setting g1 (**Custom control assignment**) > **Shutter-release button** (☞ 270), the shutter-release buttons on optional wireless remote controllers and remote cords (☞ 296) can be pressed halfway to start live view or pressed all the way down to start and end movie recording.

## Viewing Movies

Movies are indicated by a  icon in full-frame playback ( 223). Tap the  icon in the monitor or press the center of the multi selector to start playback; your current position is indicated by the movie progress bar.



The following operations can be performed:

To	Description
Pause	Press  to pause playback.
Play	Press the center of the multi selector to resume playback when movie is paused or during rewind/advance.
Rewind/ advance	Press  to rewind,  to advance. Speed increases with each press, from 2x to 4x to 8x to 16x; keep the control pressed to skip to beginning or end of movie (first frame is indicated by  in top right corner of monitor, last frame by  ). If playback is paused, the movie rewinds or advances one frame at a time; keep the control pressed for continuous rewind or advance.
Start slow-motion playback	Press  while the movie is paused to start slow-motion playback.

To	Description
Skip 10 s	Rotate the main command dial to skip ahead or back 10 s.
Skip ahead/ back	Rotate the sub-command dial to skip to next or previous index, or to skip to the last or first frame if the movie contains no indices.
Adjust volume	Press $\odot$ to increase volume, $\odot$ (🔊) to decrease.
View movie editing options	Press the $\mathbb{I}$ or $\text{OK}$ button to view movie editing options (☐ 78).
Exit	Press $\odot$ or $\triangleright$ to exit to full-frame playback.
Return to shooting mode	Press the shutter-release button halfway to exit to shooting mode.



### The $\mathbb{I}$ Icon

Movies with indices (☐ 64) are indicated by a  $\mathbb{I}$  icon in full-frame playback.



## Editing Movies

Trim footage to create edited copies of movies or save selected frames as JPEG stills.

Option	Description
 <b>Choose start/end point</b>	Create a copy from which unwanted footage has been removed.
 <b>Save current frame</b>	Save a selected frame as a JPEG still.





## Trimming Movies



To create trimmed copies of movies:

**1** Display a movie full frame ( 223).

**2** Pause the movie on the new opening frame.

Play the movie back as described in “Viewing Movies” ( 76), pressing the center of the multi selector to start and resume playback and  to pause and pressing  or  or rotating the main or sub-command dial to locate the desired frame. Your approximate position in the movie can be ascertained from the movie progress bar. Pause playback when you reach the new opening frame.



*Movie progress bar*

### 3 Select **Choose start/end point**.

Press **i** or **OK**, then highlight **Choose start/end point** and press **▶**.



### 4 Select **Start point**.

To create a copy that begins from the current frame, highlight **Start point** and press **OK**. The frames before the current frame will be removed when you save the copy in Step 9.

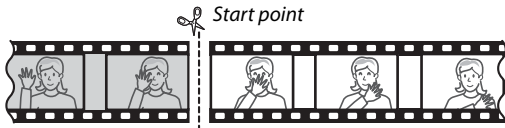
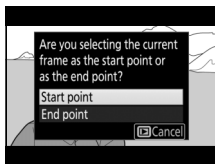





### 5 Confirm the new start point.



If the desired frame is not currently displayed, press **◀** or **▶** to advance or rewind (to skip to 10 s ahead or back, rotate the main command dial; to skip to an index, or to the first or last frame if the movie contains no indices, rotate the sub-command dial).

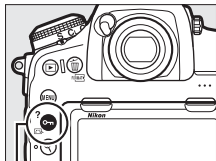

## 6 Choose the end point.

Press  (/?) to switch from the start point () to the end point () selection tool and then select the closing frame as described in Step 5. The frames after the selected frame will be removed when you save the copy in Step 9.



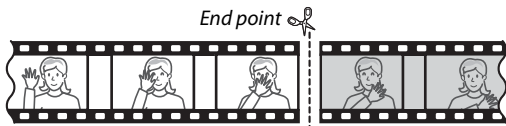

 (/?) button



## 7 Create the copy.

Once the desired frame is displayed, press .

## 8 Preview the movie.

To preview the copy, highlight **Preview** and press  (to interrupt the preview and return to the save options menu, press ). To abandon the current copy and select a new start point or end point as described above, highlight **Cancel** and press ; to save the copy, proceed to Step 9.

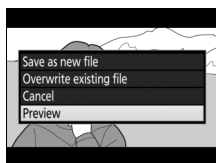



## 9 Save the copy.

Highlight **Save as new file** and press **OK** to save the copy to a new file. To replace the original movie file with the edited copy, highlight **Overwrite existing file** and press **OK**.

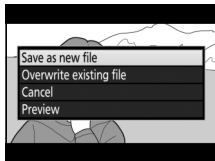

### ✓ Trimming Movies

Movies must be at least two seconds long. The copy will not be saved if there is insufficient space available on the memory card.

Copies have the same time and date of creation as the original.

### ✓ Removing Opening or Closing Footage

To remove only the opening footage from the movie, proceed to Step 7 without pressing the **OK** (**OK**/?) button in Step 6. To remove only the closing footage, select **End point** in Step 4, select the closing frame, and proceed to Step 7 without pressing the **OK** (**OK**/?) button in Step 6.

### ✓ The Retouch Menu

Movies can also be edited using the **Trim movie** option in the retouch menu (□ 279).

## Saving Selected Frames

To save a copy of a selected frame as a JPEG still:

### 1 Pause the movie on the desired frame.

Play the movie back as described in “Viewing Movies” (📖 76), pressing the center of the multi selector to start and resume playback and ⏸ to pause. Pause the movie at the frame you intend to copy.



### 2 Choose **Save current frame**.

Press **i** or **OK**, then highlight **Save current frame** and press **OK** to create a JPEG copy of the current frame. The image will be recorded at the dimensions selected for **Frame size/ frame rate** in the movie shooting menu (📖 69).

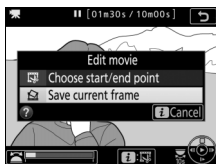

#### **Save Current Frame**

JPEG movie stills created with the **Save current frame** option cannot be retouched. JPEG movie stills lack some categories of photo information (📖 229).

# Image Recording Options



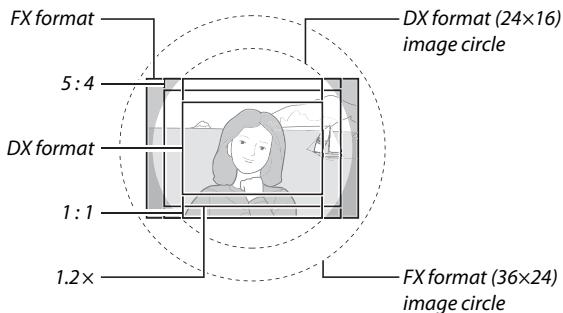

## Image Area

Choose from image areas of **FX (36×24)** (FX format), **DX (24×16)** (DX format), **5 : 4 (30×24)**, **1.2× (30×20)**, and **1:1 (24×24)**.



## ■ ■ Image Area Options

The camera offers a choice of the following image areas:

Option	Description
 <b>FX (36×24)</b>	Images are recorded in FX format with an angle of view equivalent to a NIKKOR lens on a 35 mm format camera.
 <b>1.2× (30×20)</b>	Selecting this option reduces the angle of view and increases the apparent focal length of the lens by approximately 1.2×.
 <b>DX (24×16)</b>	Images are recorded in DX format. To calculate the approximate focal length of the lens in 35 mm format, multiply by 1.5.
 <b>5 : 4 (30×24)</b>	Pictures are recorded with an aspect ratio of 5 : 4.
 <b>1 : 1 (24×24)</b>	Pictures are recorded with an aspect ratio of 1 : 1.

## ■ ■ Automatic Crop Selection

To automatically select to a DX crop when a DX lens is attached, select **On** for **Image area > Auto DX crop** in the photo shooting menu (☞ 251). The image area selected in the photo shooting menu or with the camera controls will be used only when a non-DX lens is attached. Select **Off** to use the currently-selected image area with all lenses.

### Auto DX Crop

Camera controls cannot be used to select image area when a DX lens is attached and **Auto DX crop** is on (☞ 87).

## ■ The Viewfinder Mask Display

If **On** is selected for **Image area** > **Viewfinder mask display** in the photo shooting menu, the area outside the **1.2× (30×20)**, **DX (24×16)**, **5:4 (30×24)**, and **1:1 (24×24)** crops will be shown in gray in the viewfinder.

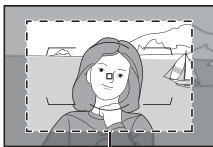

1.2× (30×20)



DX (24×16)



5:4 (30×24)



1:1 (24×24)

## ✎ DX Lenses

DX lenses are designed for use with DX format cameras and have a smaller angle of view than lenses for 35 mm format cameras. If **Auto DX crop** is off and an option other than **DX (24×16)** (DX format) is selected for **Image area** when a DX lens is attached, the edges of the image may be eclipsed. This may not be apparent in the viewfinder, but when the images are played back you may notice a drop in resolution or that the edges of the picture are blacked out.

## ✎ Image Area

The selected option is shown in the information display.



The image area can be selected using the **Image area > Choose image area** option in the photo shooting menu or by pressing a control and rotating a command dial.

## ■ The Image Area Menu

### 1 Select Image area.

Highlight **Image area** in the photo shooting menu and press .



### 2 Select Choose image area.

Highlight **Choose image area** and press .



### 3 Adjust settings.

Choose an option and press . The selected crop is displayed in the viewfinder.

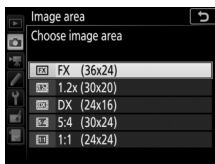

#### Image Size

Image size varies with the option selected for image area.

### 1 Assign image area selection to a camera control.

Use Custom Setting f1 (**Custom control assignment**, [□ 268](#)) to assign **Choose image area** to a control.

---

### 2 Use the selected control to choose an image area.

The image area can be selected by pressing the selected control and rotating the main or sub-command dial until the desired crop is displayed in the viewfinder ([□ 85](#)).

The option currently selected for image area can be viewed by pressing the control to display the image area in the control panel or information display. FX format is displayed as "36 - 24", 1.2 × as "30 - 20", DX format as "24 - 16", 5 : 4 as "30 - 24", and 1 : 1 as "24 - 24".

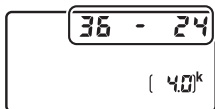

#### 🔍 See Also

For information on:

- The crops available for movie recording, see "Image Area: Choosing a Movie Crop" ([□ 68](#)).
- The number of pictures that can be stored at different image area settings, see "Memory Card Capacity" ([□ 362](#)).

## Image Quality

The D850 supports the following image quality options.

Option	File type	Description
NEF (RAW)	NEF	RAW data from the image sensor are saved without additional processing. Settings such as white balance and contrast can be adjusted after shooting.
NEF (RAW)+ JPEG fine★/ NEF (RAW)+ JPEG fine	NEF/ JPEG	Two images are recorded, one NEF (RAW) image and one fine-quality JPEG image.
NEF (RAW)+ JPEG normal★/ NEF (RAW)+ JPEG normal		Two images are recorded, one NEF (RAW) image and one normal-quality JPEG image.
NEF (RAW)+ JPEG basic★/ NEF (RAW)+ JPEG basic		Two images are recorded, one NEF (RAW) image and one basic-quality JPEG image.
JPEG fine★/ JPEG fine	JPEG	Record JPEG images at a compression ratio of roughly 1 : 4 (fine quality).
JPEG normal★/ JPEG normal		Record JPEG images at a compression ratio of roughly 1 : 8 (normal quality).
JPEG basic★/ JPEG basic		Record JPEG images at a compression ratio of roughly 1 : 16 (basic quality).
TIFF (RGB)	TIFF (RGB)	Record uncompressed TIFF-RGB images at a bit depth of 8 bits per channel (24-bit color). TIFF is supported by a wide variety of imaging applications.

### See Also

For information on the number of pictures that can be stored at different image quality and size settings, see “Memory Card Capacity” (□ 362).



Image quality is set by pressing the **QUAL** button and rotating the main command dial until the desired setting is displayed in the control panel.

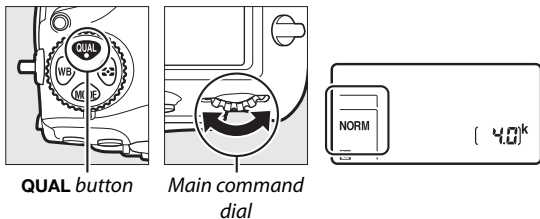

#### ☑ JPEG Compression

Image quality options with a star ("★") use compression intended to ensure maximum quality; the size of the files varies with the scene. Options without a star use a type of compression designed to produce smaller files; files tend to be roughly the same size regardless of the scene recorded.

#### ☑ NEF+JPEG



When photographs taken at settings of NEF (RAW) + JPEG are viewed on the camera with only one memory card inserted, only the JPEG image will be displayed. If both copies are recorded to the same memory card, both copies will be erased when the photo is deleted. If the JPEG copy is recorded to a separate memory card using the **Secondary slot function > RAW primary - JPEG secondary** option, each copy must be deleted separately.

#### ☑ The Image Quality Menu

Image quality can also be adjusted using the **Image quality** option in the photo shooting menu (☞ 251).

## ■■ NEF (RAW) Compression

To choose the type of compression for NEF (RAW) images, highlight **NEF (RAW) recording** > **NEF (RAW) compression** in the photo shooting menu and press .

Option	Description
ON  <b>Lossless compressed</b>	NEF images are compressed using a reversible algorithm, reducing file size by about 20–40% with no effect on image quality.
ON  <b>Compressed</b>	NEF images are compressed using a non-reversible algorithm, reducing file size by about 35–55% with almost no effect on image quality.
<b>Uncompressed</b>	NEF images are not compressed.

## ■■ NEF (RAW) Bit Depth

To choose a bit depth for NEF (RAW) images, highlight **NEF (RAW) recording** > **NEF (RAW) bit depth** in the photo shooting menu and press .

Option	Description
<b>12-bit</b> 12-bit	NEF (RAW) images are recorded at a bit-depth of 12 bits.
<b>14-bit</b> 14-bit	NEF (RAW) images are recorded at a bit depth of 14 bits, producing files larger than those with a bit depth of 12 bits but increasing the color data recorded.

### NEF (RAW) Images

JPEG copies of NEF (RAW) images can be created using Capture NX-D or other software or the **NEF (RAW) processing** option in the retouch menu ( 278).

## Image Size





Image size is measured in pixels. Choose from  **Large**,  **Medium**, or  **Small** (note that image size varies depending on the option selected for **Image area**,  83):

Image area	Option	Size (pixels)
FX (36×24; FX format)	<b>Large</b>	8256 × 5504
	<b>Medium</b>	6192 × 4128
	<b>Small</b>	4128 × 2752
1.2× (30×20)	<b>Large</b>	6880 × 4584
	<b>Medium</b>	5152 × 3432
	<b>Small</b>	3440 × 2288
DX (24×16; DX format)	<b>Large</b>	5408 × 3600
	<b>Medium</b>	4048 × 2696
	<b>Small</b>	2704 × 1800
5 : 4 (30×24)	<b>Large</b>	6880 × 5504
	<b>Medium</b>	5152 × 4120
	<b>Small</b>	3440 × 2752
1 : 1 (24×24)	<b>Large</b>	5504 × 5504
	<b>Medium</b>	4128 × 4128
	<b>Small</b>	2752 × 2752

Image size for JPEG and TIFF images can be set by pressing the **QUAL** button and rotating the sub-command dial until the desired option is displayed in the control panel. To choose the size of NEF (RAW) images, use the **Image size > NEF (RAW)** option in the photo shooting menu.

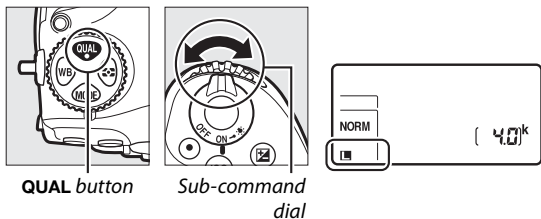

### The Image Size Menu

Image size for JPEG and TIFF images can also be adjusted using the **Image size > JPEG/TIFF** option in the photo shooting menu (☞ 251). Small and medium sized NEF (RAW) images are recorded in lossless compressed 12-bit format, regardless of the options selected for **NEF (RAW) compression** and **NEF (RAW) bit depth** in the **NEF (RAW) recording** menu.

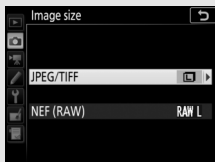

## Using Two Memory Cards

When two memory cards are inserted in the camera, you can choose one as the primary card using the **Primary slot selection** item in the photo shooting menu (☞ 250). Select **XQD card slot** to designate the card in the XQD card slot as the primary card, **SD card slot** to choose the SD card. The roles played by the primary and secondary cards can be chosen using the **Secondary slot function** option in the photo shooting menu (☞ 250). Choose from **Overflow** (the secondary card is used only when the primary card is full), **Backup** (each picture is recorded to both the primary and secondary card), and **RAW primary - JPEG secondary** (as for **Backup**, except that the NEF/RAW copies of photos shot at settings of NEF/RAW + JPEG are recorded only to the primary card and the JPEG copies only to the secondary card).

### ☑ “Backup” and “RAW Primary - JPEG Secondary”

The camera shows the number of exposures remaining on the card with the least amount of memory. Shutter release will be disabled when either card is full.

### ☑ Recording Movies

When two memory cards are inserted in the camera, the slot used to record movies can be selected using the **Destination** option in the movie shooting menu (☞ 256).

# Focus

This section describes the focus options available when photographs are framed in the viewfinder. Focus can be adjusted automatically (📖 94) or manually (📖 111). The user can also select the focus point for automatic or manual focus (📖 105) or use focus lock to focus and recompose photographs after focusing (📖 108).

## Autofocus

To use autofocus, rotate the focus-mode selector to **AF**.

*Focus-mode selector*

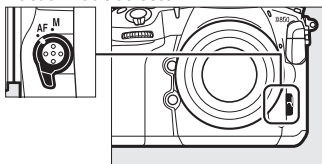

The camera focuses using 153 focus points, of which the 55 shown by □ in the illustration can be selected by the user (📖 105).

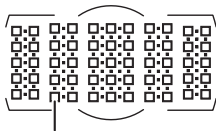

*User-selectable focus points*

## Cross Sensors

The availability of cross-sensor focus points varies with the lens used.

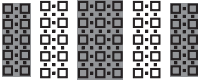
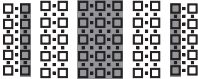
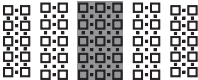
Lens	Cross sensors (cross-sensor focus points highlighted in gray <sup>2)</sup> )
AF-S and AF-P lenses other than those listed below with maximum apertures of f/4 or faster <sup>1</sup>	 <p>99 cross sensors</p>
<ul style="list-style-type: none"><li>• AF-S DX Zoom-Nikkor 12–24mm f/4G IF-ED</li><li>• AF-S Micro NIKKOR 60mm f/2.8G ED</li><li>• AF-S NIKKOR 600mm f/4G ED VR</li><li>• AF-S NIKKOR 600mm f/4E FL ED VR</li><li>• AF-S Nikkor 600mm f/4D IF-ED II</li><li>• AF-S Nikkor 600mm f/4D IF-ED</li></ul>	 <p>63 cross sensors</p>
<ul style="list-style-type: none"><li>• AF-S NIKKOR 200–400mm f/4G ED VR II</li><li>• AF-S VR Zoom-Nikkor 200–400mm f/4G IF-ED</li><li>• AF-S NIKKOR 500mm f/4G ED VR</li><li>• AF-S Nikkor 500mm f/4D IF-ED II</li><li>• AF-S Nikkor 500mm f/4D IF-ED</li><li>• AF-S and AF-P lenses with maximum apertures slower than f/4<sup>1</sup></li><li>• Non-AF-S, non-AF-P lenses</li></ul>	 <p>45 cross sensors</p>

1 At maximum zoom, in the case of zoom lenses.

2 Other focus points use line sensors, which detect horizontal lines.

## AF-S/AF-I Teleconverters and Available Focus Points

When an AF-S or AF-I teleconverter is attached, the focus points shown in the illustrations can be used for autofocus and electronic rangefinding (note that at maximum combined apertures slower than  $f/5.6$ , the camera may not be able to focus on dark or low-contrast subjects).

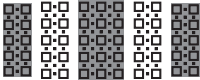
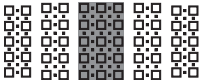
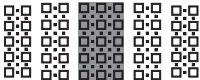
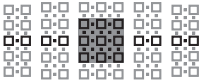
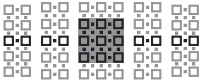
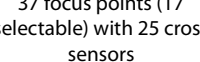
Teleconverter	Max. lens aperture <sup>1</sup>	Available focus points (cross-sensor focus points highlighted in gray <sup>2</sup> )
TC-14E, TC-14E II, TC-14E III TC-17E II TC-20E, TC-20E II, TC-20E III	$f/2$	 153 focus points (55 selectable) with 99 cross sensors
TC-14E, TC-14E II, TC-14E III	$f/2.8$	 153 focus points (55 selectable) with 45 cross sensors
TC-17E II TC-20E, TC-20E II, TC-20E III	$f/2.8$	 153 focus points (55 selectable) with 45 cross sensors
TC-14E, TC-14E II, TC-14E III	$f/4$	 37 focus points (17 selectable) with 25 cross sensors
TC-17E II	$f/4$	 37 focus points (17 selectable) with 25 cross sensors
TC-800-1.25E ED	$f/5.6$	 37 focus points (17 selectable) with 25 cross sensors

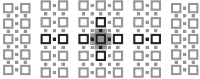

Teleconverter	Max. lens aperture <sup>1</sup>	Available focus points (cross-sensor focus points highlighted in gray <sup>2</sup> )
TC-20E, TC-20E II, TC-20E III	f/4	
TC-14E, TC-14E II, TC-14E III	f/5.6	15 focus points (9 selectable) with 5 cross sensors

1 At maximum zoom, in the case of zoom lenses.

2 Other focus points use line sensors, which detect horizontal lines, but note that if there are only 5 cross sensors, only those shown by ■ detect vertical lines.

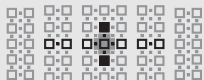

Autofocus is not available when teleconverters are used with AF-S VR Micro-Nikkor 105mm f/2.8G IF-ED lenses.

## Autofocus Mode

Choose from the following autofocus modes:

Mode	Description
<b>AF-S</b>	<b>Single-servo AF:</b> For stationary subjects. Focus locks when shutter-release button is pressed halfway. At default settings, shutter can only be released when in-focus indicator (●) is displayed ( <i>focus priority</i> ; □ 260).
<b>AF-C</b>	<b>Continuous-servo AF:</b> For moving subjects. Camera focuses continuously while shutter-release button is pressed halfway; if subject moves, camera will engage <i>predictive focus tracking</i> (□ 99) to predict final distance to subject and adjust focus as necessary. At default settings, shutter can be released whether or not subject is in focus ( <i>release priority</i> ; □ 260).

Autofocus mode can be selected by pressing the AF-mode button and rotating the main command dial until the desired setting is displayed in the viewfinder and control panel.

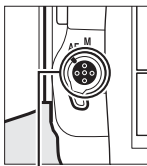

AF-mode button

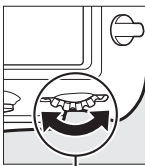

Main command dial

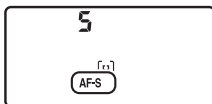

Control panel



Viewfinder

### The AF-ON Button

For the purpose of focusing the camera, pressing the **AF-ON** button has the same effect as pressing the shutter-release button halfway.

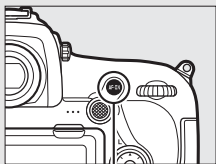











AF-ON button

### Predictive Focus Tracking

In **AF-C** mode, the camera will initiate predictive focus tracking if the subject moves toward or away from the camera while the shutter-release button is pressed halfway or the **AF-ON** button is pressed. This allows the camera to track focus while attempting to predict where the subject will be when the shutter is released.

### See Also

For information on:

- Using focus priority in continuous-servo AF, see  > Custom Setting a1 (**AF-C priority selection**,  260).
- Using release priority in single-servo AF, see  > Custom Setting a2 (**AF-S priority selection**,  260).
- Preventing the camera from focusing when the shutter-release button is pressed halfway, see  > Custom Setting a8 (**AF activation**,  261).
- Limiting focus-mode selection to **AF-S** or **AF-C**, see  > Custom Setting a10 (**Autofocus mode restrictions**,  262).
- Using the sub-command dial to choose the focus mode, see  > Custom Setting f4 (**Customize command dials**) > **Change main/sub** ( 269).
- The autofocus options available in live view or during movie recording, see “Autofocus” ( 41).

## **AF-Area Mode**

Choose how the focus point for autofocus is selected.

- **Single-point AF:** Select the focus point; the camera will focus on the subject in the selected focus point only. Use with stationary subjects.
- **Dynamic-area AF:** Select the focus point. In **AF-C** focus mode, the camera will focus based on information from surrounding focus points if the subject briefly leaves the selected point. The number of focus points varies with the mode selected:
  - **9- or 25-point dynamic-area AF:** Choose when there is time to compose the photograph or when photographing subjects that are moving predictably (e.g., runners or race cars on a track).
  - **72-point dynamic-area AF:** Choose when photographing subjects that are moving unpredictably (e.g., players at a football game).
  - **153-point dynamic-area AF:** Choose when photographing subjects that are moving quickly and cannot be easily framed in the viewfinder (e.g., birds).

- **3D-tracking:** Select the focus point. In **AF-C** focus mode, the camera will track subjects that leave the selected focus point and select new focus points as required. Use to quickly compose pictures with subjects that are moving erratically from side to side (e.g., tennis players). If the subject leaves viewfinder, remove your finger from the shutter-release button and recompose the photograph with the subject in the selected focus point.



- **Group-area AF:** The camera focuses using a group of focus points selected by the user, reducing the risk of the camera focusing on the background instead of on the main subject. Choose for subjects that are difficult to photograph using a single focus point. If faces are detected in **AF-S** focus mode, the camera will give priority to portrait subjects.
- **Auto-area AF:** The camera automatically detects the subject and selects the focus point; if a face is detected, the camera will give priority to the portrait subject. The active focus points are highlighted briefly after the camera focuses; in **AF-C** mode, the main focus point is displayed after the other focus points have turned off.



AF-area mode can be selected by pressing the AF-mode button and rotating the sub-command dial until the desired setting is displayed in the viewfinder and control panel.

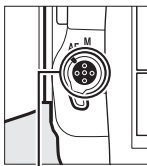

*AF-mode button*

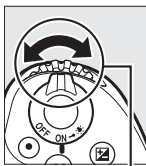

*Sub-command dial*

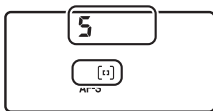

*Control panel*

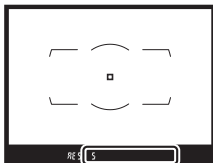

















*Viewfinder*

### 3D-tracking

When the shutter-release button is pressed halfway, the colors in the area surrounding the focus point are stored in the camera. Consequently 3D-tracking may not produce the desired results with subjects that are similar in color to the background or that occupy a very small area of the frame.

## AF-Area Mode

AF-area mode is shown in the control panel and viewfinder.

AF-area mode	Control panel	Viewfinder	Viewfinder focus-point display
Single-point AF	S		
9-point dynamic-area AF*	d 9		
25-point dynamic-area AF*	d 25		
72-point dynamic-area AF*	d 72		
153-point dynamic-area AF*	d 153		
3D-tracking	3d		
Group-area AF	GrP		
Auto-area AF	Auto		







\* Only active focus point is displayed in the viewfinder. Remaining focus points provide information to assist focus operation.

### **AF-S/AF-I Teleconverters**

If 3D-tracking or auto-area AF is selected for AF-area mode when an AF-S/AF-I teleconverter is used, single-point AF will automatically be selected at combined apertures slower than f/5.6.

### **See Also**

For information on:

- How autofocus adjusts to changes in the distance to the subject, see  > Custom Setting a3 (**Focus tracking with lock-on**, □ 260).
- Choosing whether the camera detects and focuses on faces when 3D-tracking is selected for AF-area mode, see  > Custom Settings a4 (**3D-tracking face-detection**, □ 260).
- Choosing the area monitored by pressing the shutter-release button halfway when 3D-tracking is selected for AF-area mode, see  > Custom Settings a5 (**3D-tracking watch area**, □ 261).
- Choosing different focus points and/or AF-area modes for portrait- and landscape-orientation photographs, see  > Custom Settings a7 (**Store by orientation**, □ 261).
- Limiting AF-area mode selection, see  > Custom Settings a9 (**Limit AF-area mode selection**, □ 261).
- Choosing how the focus point is displayed, see  > Custom Settings a12 (**Focus point options**, □ 262).
- Using the main command dial to choose the AF-area mode, see  > Custom Settings f4 (**Customize command dials**) > **Change main/sub** (□ 269).
- The autofocus options available in live view or during movie recording, see “Choosing an AF-Area Mode” (□ 42).



## Focus Point Selection

The camera focuses using 153 focus points, of which 55 shown in the illustration can be selected manually, allowing photographs to be composed with the main subject positioned almost anywhere in the frame. Follow the steps below to choose the focus point (in group-area AF, you can follow these steps to choose a group of focus points).

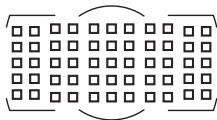

### 1 Rotate the focus selector lock to ●.

This allows the multi selector to be used to select the focus point.

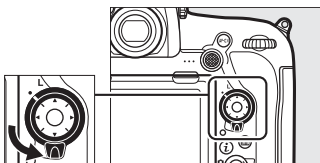

Focus selector lock

### 2 Select the focus point.

Use the multi selector to select the focus point in the viewfinder while the exposure meters are on. The center focus point can be selected by pressing the center of the multi selector.

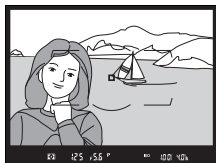
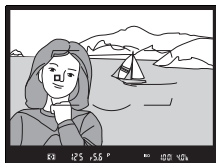

The focus selector lock can be rotated to the locked (L) position following selection to prevent the selected focus point from changing when the multi selector is pressed.

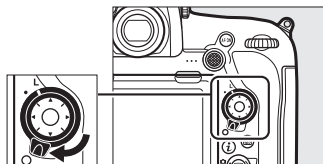

### The Sub-selector

The sub-selector can be used in place of the multi selector to select the focus point. Focus and exposure lock while the center of the sub-selector is pressed (□ 108, 137). Use the sub-selector as shown; pressing the sides may not have the desired effect. Be careful not to put your fingers or fingernails in your eye when using the sub-selector.

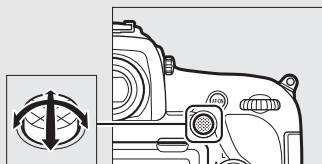













*Sub-selector*

### Auto-area AF

The focus point for auto-area AF is selected automatically; manual focus-point selection is not available.

### See Also

For information on:

- Choosing the number of focus points that can be selected using the multi selector, see  > Custom Setting a6 (**Number of focus points**,  261).
- Choosing separate focus points and/or AF-area modes for vertical and horizontal orientations, see  > Custom Setting a7 (**Store by orientation**,  261).
- Setting focus-point selection to “wrap around,” see  > Custom Setting a11 (**Focus point wrap-around**,  262).
- Choosing when the focus point is illuminated, see  > Custom Setting a12 (**Focus point options**,  262).
- Changing the role played by the sub-selector, see  > Custom Setting f1 (**Custom control assignment**) > **Sub-selector** ( 268) and **Sub-selector center** ( 268).
- Changing the role of the multi selector center button, see  > Custom Setting f2 (**Multi selector center button**,  268).

## Focus Lock

Focus lock can be used to change the composition after focusing, making it possible to focus on a subject that will not be in a focus point in the final composition. If the camera is unable to focus using autofocus (□ 110), focus lock can also be used to recompose the photograph after focusing on another object at the same distance as your original subject. Focus lock is most effective when an option other than auto-area AF is selected for AF-area mode (□ 100).

### 1 Focus.

Position the subject in the selected focus point and press the shutter-release button halfway to initiate focus. Check that the in-focus indicator (●) appears in the viewfinder.



### 2 Lock focus.

**AF-C focus mode** (□ 98): With the shutter-release button pressed halfway (①), press the center of the sub-selector (②) to lock both focus and exposure (an **AE-L** icon will be displayed in the viewfinder). Focus will remain locked while the center of the sub-selector is pressed, even if you later remove your finger from the shutter-release button.

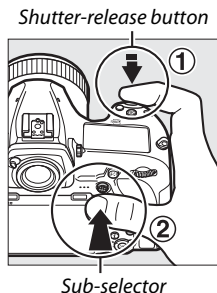

**AF-S focus mode:** Focus locks automatically when the in-focus indicator (●) appears, and remains locked until you remove your finger from the shutter-release button. Focus can also be locked by pressing the center of the sub-selector (see above).

### 3 Recompose the photograph and shoot.

Focus will remain locked between shots if you keep the shutter-release button pressed halfway (**AF-S**) or keep the center of the sub-selector pressed, allowing several photographs in succession to be taken at the same focus setting.



Do not change the distance between the camera and the subject while focus lock is in effect. If the subject moves, focus again at the new distance.

#### 🔍 Locking Focus with the AF-ON Button

During viewfinder photography, focus can be locked using the **AF-ON** button in place of the shutter-release button (📖 99). If **AF-ON only** is selected for Custom Setting a8 (**AF activation**, 📖 261), the camera will not focus when the shutter-release button is pressed halfway; instead, the camera will focus when the **AF-ON** button is pressed, at which point focus will lock and remain locked until the **AF-ON** button is pressed again.

#### 🔍 See Also

For information on using the shutter-release button to lock exposure, see 🖋 > Custom Setting c1 (**Shutter-release button AE-L**, 📖 263).

## Getting Good Results with Autofocus

Autofocus does not perform well under the conditions listed below. The shutter release may be disabled if the camera is unable to focus under these conditions, or the in-focus indicator (●) may be displayed and the camera may sound a beep, allowing the shutter to be released even when the subject is not in focus. In these cases, use manual focus (□ 111) or use focus lock (□ 108) to focus on another subject at the same distance and then recompose the photograph.



*There is little or no contrast between the subject and the background.*

**Example:** Subject is the same color as the background.



*The focus point contains objects at different distances from the camera.*

**Example:** Subject is inside a cage.



*The subject is dominated by regular geometric patterns.*

**Example:** Blinds or a row of windows in a skyscraper.

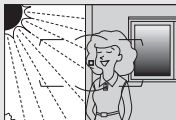

*The focus point contains areas of sharply contrasting brightness.*

**Example:** Subject is half in the shade.



*Background objects appear larger than the subject.*

**Example:** A building is in the frame behind the subject.

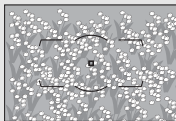

*The subject contains many fine details.*

**Example:** A field of flowers or other subjects that are small or lack variation in brightness.

## Manual Focus

Manual focus is available for lenses that do not support autofocus (non-AF NIKKOR lenses) or when the autofocus does not produce the desired results (▢ 110).

- **AF lenses:** Set the lens focus mode switch (if present) and camera focus-mode selector to **M**.

*Focus-mode selector*

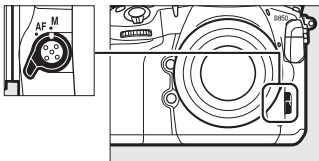

### AF Lenses

Do not use AF lenses with the lens focus-mode switch set to **M** and the camera focus-mode selector set to **AF**. Failure to observe this precaution could damage the camera or lens. This does not apply to AF-S and AF-P lenses, which can be used in **M** mode without setting the camera focus-mode selector to **M**.

- **Manual focus lenses:** Focus manually.

To focus manually, adjust the lens focus ring until the image displayed on the clear matte field in the viewfinder is in focus. Photographs can be taken at any time, even when the image is not in focus.

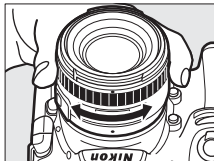

## ■ The Electronic Rangefinder

The viewfinder focus indicator can be used to confirm whether the subject in the selected focus point is in focus (the focus point can be selected from any of the 55 focus points). After positioning the subject in the selected focus point, press the shutter-release button halfway and rotate the lens focus ring until the in-focus indicator (●) is displayed. Note that with the subjects listed in “Getting Good Results with Autofocus” (📖 110), the in-focus indicator may sometimes be displayed when the subject is not in focus; confirm focus in the viewfinder before shooting. For information on using the electronic rangefinder with optional AF-S/AF-I teleconverters, see “AF-S/AF-I Teleconverters and Available Focus Points” (📖 96).



## 🔪 AF-P Lenses

When an AF-P lens (📖 281) is used in manual focus mode, the in-focus indicator will flash in the viewfinder (or in live view, the focus point will flash in the monitor) to warn that continuing to rotate the focus ring in the current direction will not bring the subject into focus.

## 🔪 Focal Plane Position

To determine the distance between your subject and the camera, measure from the focal plane mark (⊖) on the camera body. The distance between the lens mounting flange and the focal plane is 46.5 mm (1.83 in.).

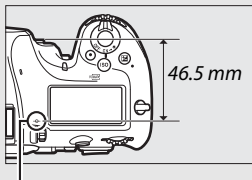

Focal plane mark



# Release Mode

## Choosing a Release Mode

To choose a release mode, press the release mode dial lock release and turn the release mode dial so that the pointer aligns with the desired setting.

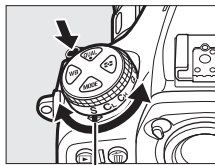

Pointer

Mode	Description
S	<b>Single frame:</b> The camera takes one photograph each time the shutter-release button is pressed.
CL	<b>Continuous low speed:</b> While shutter-release button is held down, camera takes photographs at frame rate selected for Custom Setting d1 ( <b>CL mode shooting speed</b> , □ 114, 264).
CH	<b>Continuous high speed:</b> While shutter-release button is held down, camera takes photographs at frame rate given in "Power Source and Frame Rate" (□ 114). Use for active subjects.
Q	<b>Quiet shutter-release:</b> As for single frame, except that the mirror does not click back into place while the shutter-release button is fully pressed, allowing the user to control the timing of the click made by the mirror, which is also quieter than in single frame mode. In addition, a beep does not sound regardless of the setting selected for <b>Beep options</b> > <b>Beep on/off</b> in the setup menu (□ 274).
QC	<b>QC (quiet continuous) shutter-release:</b> While shutter-release button is held down, camera records up to 3 frames per second. Camera noise is reduced.
⌚	<b>Self-timer:</b> Take pictures with the self-timer (□ 116).

Mode	Description
MUP	<b>Mirror up:</b> Choose this mode to minimize camera shake in telephoto or close-up photography or in other situations in which the slightest camera movement can result in blurred photographs (☞ 118).

## **Power Source and Frame Rate**

The maximum frame advance rate varies with the power source. The figures below are the average maximum frame rates available with continuous-servo AF, manual or shutter-priority auto exposure, a shutter speed of  $\frac{1}{250}$  s or faster, settings other than Custom Setting d1 at default values, and memory remaining in the memory buffer.

Power source	Maximum frame rate (fps)	
	CH	CL
Camera with EN-EL15a battery or with EP-5B power connector and EH-5c/ EH-5b AC adapter	7	1–6
Camera with MB-D18 (EN-EL15a or AA)	7	1–6
Camera with MB-D18 (EN-EL18b)	9	1–8

The stated rates may not be available under some conditions. Frame rate drops with some lenses, at slow shutter speeds, very small apertures (high f-numbers), or high ISO sensitivities (Hi 0.3 to Hi 2), or when ISO sensitivity is altered via auto ISO sensitivity control (☞ 121), flicker is detected with **Enable** selected for **Flicker reduction > Flicker reduction setting** in the photo shooting menu (☞ 254), vibration reduction (available with VR lenses) is on, the battery is low, the AA batteries inserted in the MB-D18 battery pack are low or cold, or a non-CPU lens is attached with **Aperture ring** selected for Custom Setting f4 (**Customize command dials**) > **Aperture setting** (☞ 269).

## The Memory Buffer

The camera is equipped with a memory buffer for temporary storage, allowing shooting to continue while photographs are being saved to the memory card. Note, however, that frame rate will drop when the buffer is full ()

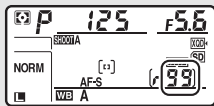

The approximate number of images that can be stored in the memory buffer at current settings is shown in the exposure-count displays in the viewfinder and control panel while the shutter-release button is pressed halfway, and can be viewed in the monitor during live view. The number may drop briefly immediately after the camera is turned on.



While photographs are being recorded to the memory card, the memory card access lamp will light. Depending on shooting conditions and memory card performance, recording may take from a few seconds to a few minutes. *Do not remove the memory card or remove or disconnect the power source until the access lamp has gone out.* If the camera is switched off while data remain in the buffer, the power will not turn off until all images in the buffer have been recorded. If the battery is exhausted while images remain in the buffer, the shutter release will be disabled and the images transferred to the memory card.

## See Also

For information on:

- Choosing the order in which the photos in each burst are displayed after shooting, see  > **After burst, show** (□ 249).
- Choosing the maximum number of photographs that can be taken in a single burst, see  > Custom Setting d2 (**Max. continuous release**, □ 264).
- The number of pictures that can be taken in a single burst, see “Memory Card Capacity” (□ 362).

## Self-Timer Mode (☺)

The self-timer can be used to reduce camera shake or for self-portraits.

### 1 Select self-timer mode.

Press the release mode dial lock release and turn the release mode dial to ☺.

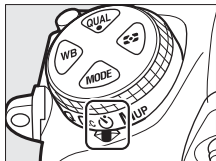

### 2 Frame the photograph and focus.

In single-servo AF (📖 98), photographs can only be taken if the in-focus (●) indicator appears in the viewfinder.



#### Close the Viewfinder Eyepiece Shutter

When taking photos without your eye to the viewfinder, close the viewfinder eyepiece shutter to prevent light entering via the viewfinder from appearing in photographs or interfering with exposure.



### 3 Start the timer.





Press the shutter-release button all the way down to start the timer. The self-timer lamp will start to flash. Two seconds before the photograph is taken, the self-timer lamp will stop flashing. The shutter will be released about ten seconds after the timer starts.



To turn the self-timer off before a photograph is taken, turn the release mode dial to another setting.

#### See Also

For information on:

- Choosing the duration of the self-timer, the number of shots taken, and the interval between shots, see  > Custom Setting c3 (**Self-timer**;  264).
- The beeps that sound when the self-timer is used, see  > **Beep options** ( 274).

## Mirror up Mode (MUP)

Choose this mode to minimize blurring caused by camera movement when the mirror is raised. To use mirror-up mode, press the release mode dial lock release and rotate the release mode dial to **MUP** (mirror up). After pressing the shutter-release button halfway to set focus and exposure, press the shutter-release button the rest of the way down to raise the mirror. **r dY** will be displayed in the control panel; press the shutter-release button all the way down again to take the picture (in live view, there is no need to raise the mirror; the picture is taken the first time the shutter-release button is pressed all the way down). A beep will sound, unless **Off** is selected for **Beep options > Beep on/off** in the setup menu (📖 274). The mirror lowers when shooting ends.

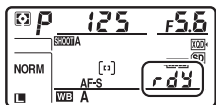
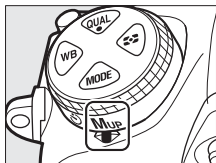

### ✔ Mirror Up

While the mirror is raised, photos cannot be framed in the viewfinder and autofocus and metering will not be performed.

### ✎ Mirror up Mode

A picture will be taken automatically if no operations are performed for about 30 s after the mirror is raised.

### ✎ Preventing Blur

To prevent blurring caused by camera movement, press the shutter-release button smoothly. Use of a tripod is recommended.

### ✎ See Also

For information on using the electronic front-curtain shutter to further reduce blur, see ✎ > Custom Setting d6 (**Electronic front-curtain shutter**, 📖 265).

# ISO Sensitivity

## Manual Adjustment

The camera's sensitivity to light can be adjusted according to the amount of light available. Choose from settings that range from ISO 64 and ISO 25600 in steps equivalent to  $\frac{1}{3}$  EV. Settings of from about 0.3 to 1 EV below ISO 64 and 0.3 to 2 EV above ISO 25600 are also available for special situations. The higher the ISO sensitivity, the less light needed to make an exposure, allowing higher shutter speeds or smaller apertures.

ISO sensitivity can be adjusted by pressing the **ISO** (FORMAT) button and rotating the main command dial until the desired setting is displayed in the control panel and viewfinder.

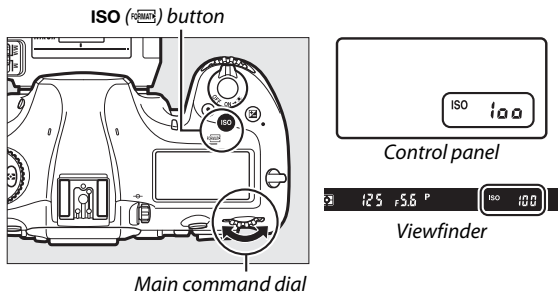

### The ISO Sensitivity Menu

ISO sensitivity can also be adjusted using the **ISO sensitivity settings** option in the photo shooting menu (☰ 252).



### **ISO Sensitivity**

The higher the ISO sensitivity, the less light needed to make an exposure, allowing faster shutter speeds or smaller apertures, but the more likely the image is to be affected by noise (randomly-spaced bright pixels, fog, or lines). Noise is particularly likely at settings between **Hi 0.3** and **Hi 2**.

### **Hi 0.3–Hi 2**









The settings **Hi 0.3** through **Hi 2** correspond to ISO sensitivities 0.3–2 EV over ISO 25600 (ISO 32000–102400 equivalent).

### **Lo 0.3–Lo 1**

The settings **Lo 0.3** through **Lo 1** correspond to ISO sensitivities 0.3–1 EV below ISO 64 (ISO 50–32 equivalent). Use for larger apertures when lighting is bright. Contrast is slightly higher than normal; in most cases, ISO sensitivities of ISO 64 or above are recommended.

### **See Also**

For information on:

- Choosing the ISO sensitivity step size, see  > Custom Setting b1 (**ISO sensitivity step value**;  262).
- Displaying ISO sensitivity in the control panel, see  > Custom Setting d3 (**ISO display**;  264).
- Reducing noise in photos taken at high ISO sensitivities, see  > **High ISO NR** ( 253).
- Reducing noise in movies shot at high ISO sensitivities, see  > **High ISO NR** ( 258).



## Auto ISO Sensitivity Control

If **On** is selected for **ISO sensitivity settings** > **Auto ISO sensitivity control** in the photo shooting menu, ISO sensitivity will automatically be adjusted if optimal exposure cannot be achieved at the value selected by the user (ISO sensitivity is adjusted appropriately when the flash is used).

- 1 Select Auto ISO sensitivity control.**  
Select **ISO sensitivity settings** in the photo shooting menu, highlight **Auto ISO sensitivity control** and press .

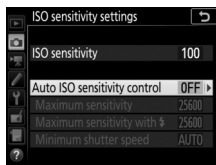

- 2 Select On.**  
Highlight **On** and press  (if **Off** is selected, ISO sensitivity will remain fixed at the value selected by the user).

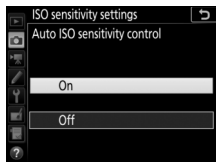

### 3 Adjust settings.

The maximum value for auto ISO sensitivity can be selected using **Maximum sensitivity** (the minimum value for auto ISO sensitivity is automatically set to ISO 64; note that if the ISO sensitivity selected by the user is higher than that chosen for **Maximum sensitivity**, the value selected by the user will be used instead). In exposure modes **P** and **A**, sensitivity will only be adjusted if underexposure would result at the shutter speed selected for **Minimum shutter speed** ( $1/4000$ –30 s, or **Auto**; in modes **S** and **M**, ISO sensitivity will be adjusted for optimal exposure at the shutter speed selected by the user). If **Auto** is selected, the camera will choose the minimum shutter speed based on the focal length of the lens; choosing fast speeds when photographing fast-moving subjects reduces blur. Press  $\odot$  to exit when settings are complete.

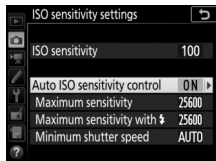

To choose the maximum ISO sensitivity for photos taken using an optional flash unit, use **Maximum sensitivity with  $\downarrow$** . Selecting **Same as without flash** sets the maximum ISO sensitivity for flash photography to the value currently selected for **Maximum sensitivity**.

When **On** is selected, the viewfinder and control panel show **ISO AUTO**. When sensitivity is altered from the value selected by the user, these indicators flash and the altered value is shown in the viewfinder and control panel.

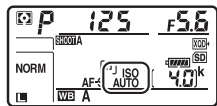



### ✎ Minimum Shutter Speed

Auto shutter-speed selection can be fine-tuned by highlighting **Auto** and pressing : for example, values faster than those usually selected automatically can be used with telephoto lenses to reduce blur. Note, however, that **Auto** functions only with CPU lenses; if a non-CPU lens is used without lens data, minimum shutter speed is fixed at  $1/30$  s. Shutter speeds may drop below the selected minimum if optimum exposure cannot be achieved at the ISO sensitivity chosen for **Maximum sensitivity**.



### ✎ Turning Auto ISO Sensitivity Control On or Off

You can turn auto ISO sensitivity control on or off by pressing the **ISO**  button and rotating the sub-command dial. The control panel and viewfinder display **ISO AUTO** icons when auto ISO sensitivity control is on and **ISO** when it is off.

### ✎ Auto ISO Sensitivity Control

When a flash is used, minimum shutter speed will be set to the value selected for **Minimum shutter speed** unless this value is faster than Custom Setting e1 (**Flash sync speed**,  266) or slower than Custom Setting e2 (**Flash shutter speed**,  266), in which case the value selected for Custom Setting e2 will be used instead. Note that ISO sensitivity may be raised automatically when auto ISO sensitivity control is used in combination with slow sync flash modes (available with compatible optional flash units), possibly preventing the camera from selecting slow shutter speeds.





### ✎ See Also

For information on choosing the reference used to set exposure when a flash is used with auto ISO sensitivity control, see  > Custom Setting e4 (**Auto  $\frac{1}{2}$  ISO sensitivity control**,  267).

# Exposure

## Metering



Metering determines how the camera sets exposure. The following options are available:

Option	Description
	<b>Matrix:</b> Produces natural results in most situations. Camera meters wide area of the frame and sets exposure according to tone distribution, color, composition, and, with type G, E, or D lenses (☐ 281), distance information (3D color matrix metering III; with other CPU lenses, camera uses color matrix metering III, which does not include 3D distance information).
	<b>Center-weighted:</b> Camera meters entire frame but assigns greatest weight to center area (if CPU lens is attached, size of area can be selected using Custom Setting b6, <b>Center-weighted area</b> , ☐ 263; if non-CPU or AF-S Fisheye NIKKOR 8–15mm f/3.5–4.5E ED lens is attached, area is equivalent to circle 12 mm in diameter). Classic meter for portraits; recommended when using filters with an exposure factor (filter factor) over 1×.
	<b>Spot:</b> Camera meters circle 4 mm (0.16 in.) in diameter (approximately 1.5% of frame). Circle is centered on current focus point, making it possible to meter off-center subjects (if non-CPU or AF-S Fisheye NIKKOR 8–15mm f/3.5–4.5E ED lens is used or if auto-area AF is in effect, camera will meter center focus point). Ensures that subject will be correctly exposed, even when background is much brighter or darker.
	<b>Highlight-weighted:</b> Camera assigns greatest weight to highlights. Use to reduce loss of detail in highlights, for example when photographing spotlight performers on-stage.

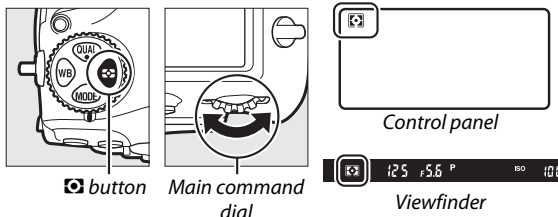
To choose a metering option, press the  button and rotate the main command dial until the desired setting is displayed in the viewfinder and control panel.







### Non-CPU Lens Data

Specifying the focal length and maximum aperture of non-CPU lenses using the **Non-CPU lens data** option in the setup menu ( 218) allows the camera to use color matrix metering when matrix is selected and improves the accuracy of center-weighted and spot metering. Center-weighted metering will be used if highlight-weighted metering is selected with non-CPU lenses or if matrix metering is selected with non-CPU lenses for which lens data have not been supplied. Note that center-weighted metering may also be used if highlight-weighted metering is selected with certain CPU lenses (AI-P NIKKOR lenses and AF lenses that are not of type G, E, or D;  284).

### See Also

For information on:

- Choosing whether matrix metering uses face detection, see  > Custom Setting b5 (**Matrix metering**,  263).
- Making separate adjustments to optimal exposure for each metering method, see  > Custom Setting b7 (**Fine-tune optimal exposure**,  263).

## Exposure Mode

To determine how the camera sets shutter speed and aperture when adjusting exposure, press the **MODE** button and rotate the main command dial until the desired option appears in the control panel.

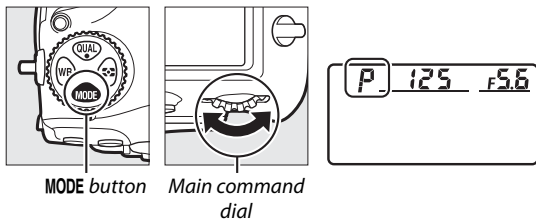

Mode	Description
<b>P</b>	<b>Programmed auto</b> (☞ 128): Camera sets shutter speed and aperture for optimal exposure. Recommended for snapshots and in other situations in which there is little time to adjust camera settings.
<b>S</b>	<b>Shutter-priority auto</b> (☞ 129): User chooses shutter speed; camera selects aperture for best results. Use to freeze or blur motion.
<b>A</b>	<b>Aperture-priority auto</b> (☞ 130): User chooses aperture; camera selects shutter speed for best results. Use to blur background or bring both foreground and background into focus.
<b>M</b>	<b>Manual</b> (☞ 131): User controls both shutter speed and aperture. Set shutter speed to Bulb (b u l b) or Time (- -) for long time-exposures.

### **Lens Types**

When using a CPU lens equipped with an aperture ring (□ 284), lock the aperture ring at the minimum aperture (highest f-number). Type G and E lenses are not equipped with an aperture ring.

When using non-CPU lenses (□ 218), select exposure mode **A** (aperture-priority auto) or **M** (manual). In other modes, exposure mode **A** is automatically selected when a non-CPU lens is attached (□ 284). The exposure mode indicator (**P** or **S**) will flash in the control panel and **A** will be displayed in the viewfinder.

### **Depth-of-Field Preview**

To preview the effects of aperture, press and hold the **Pv** button. The lens will be stopped down to the aperture value selected by the camera (modes **P** and **S**) or the value chosen by the user (modes **A** and **M**), allowing depth of field to be previewed in the viewfinder.

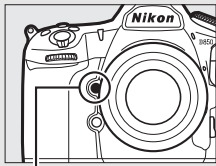

**Pv** button

### **Custom Setting e5—Modeling Flash**

This setting controls whether optional flash units that support the Nikon Creative Lighting System (CLS; □ 288) will emit a modeling flash when the **Pv** button is pressed.

## **P: Programmed Auto**

In this mode, the camera automatically adjusts shutter speed and aperture according to a built-in program to ensure optimal exposure in most situations.

### **Flexible Program**

In exposure mode **P**, different combinations of shutter speed and aperture can be selected by rotating the main command dial while the exposure meters are on (“flexible program”). All combinations produce the same exposure. While flexible program is in effect, an asterisk (“\*”) appears in the control panel. To restore default shutter speed and aperture settings, rotate the dial until the asterisk is no longer displayed, choose another mode, or turn the camera off.

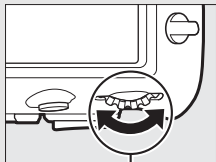

*Main command dial*

### **See Also**

For information on activating the exposure meters, see “The Standby Timer (Viewfinder Photography)” (□ 34).



## **S: Shutter-Priority Auto**

In shutter-priority auto, you choose the shutter speed while the camera automatically selects the aperture that will produce the optimal exposure.

To choose a shutter speed, rotate the main command dial while the exposure meters are on. Shutter speed can be set to "x 250" or to values between 30 s and  $\frac{1}{8000}$  s. Shutter speed can be locked at the selected setting (📖 136).

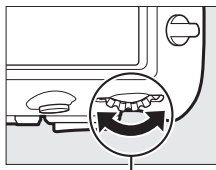

*Main command dial*

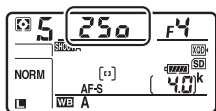

## A: Aperture-Priority Auto

In aperture-priority auto, you choose the aperture while the camera automatically selects the shutter speed that will produce the optimal exposure.

To choose an aperture between the minimum and maximum values for the lens, rotate the sub-command dial while the exposure meters are on. Aperture can be locked at the selected setting (📖 136).

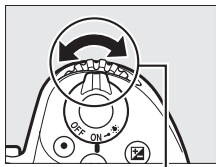

Sub-command dial

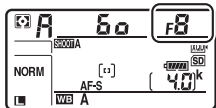

### 🔪 Non-CPU Lenses (📖 284)

Use the lens aperture ring to adjust aperture. If the maximum aperture of the lens has been specified using the **Non-CPU lens data** item in setup menu (📖 218) when a non-CPU lens is attached, the current f-number will be displayed in the viewfinder and control panel, rounded to the nearest full stop.

Otherwise the aperture displays will show only the number of stops ( $\Delta F$ , with maximum aperture displayed as  $\Delta F0$ ) and the f-number must be read from the lens aperture ring.

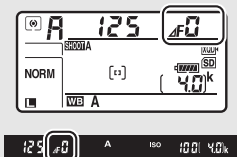

## **M: Manual**

In manual exposure mode, you control both shutter speed and aperture. While the exposure meters are on, rotate the main command dial to choose a shutter speed, and the sub-command dial to set aperture. Shutter speed can be set to “x 250” or to values between 30 s and  $1/8000$  s, or the shutter can be held open indefinitely for a long time-exposure (b u l b or - -, 133). Aperture can be set to values between the minimum and maximum values for the lens. Use the exposure indicators to check exposure.

*Aperture*

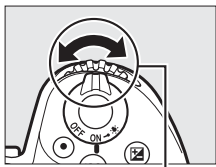

*Sub-command dial*

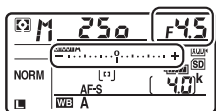

*Shutter speed*

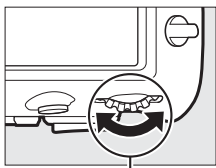

*Main command dial*

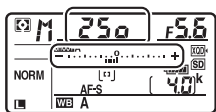







Shutter speed and aperture can be locked at the selected setting (136).

## AF Micro NIKKOR Lenses

Provided that an external exposure meter is used, the exposure ratio need only be taken into account when the lens aperture ring is used to set aperture.

## Exposure Indicators

The exposure indicators in the viewfinder and control panel show whether the photograph would be under- or over-exposed at current settings. Depending on the option chosen for Custom Setting b2 (**EV steps for exposure ctrl**,  262), the amount of under- or over-exposure is shown in increments of  $\frac{1}{3}$  EV,  $\frac{1}{2}$  EV, or 1 EV. If the limits of the exposure metering system are exceeded, the displays will flash.

Custom Setting b2 set to 1/3 step			
	Optimal exposure	Underexposed by $\frac{1}{3}$ EV	Overexposed by over 3 EV
Control panel			
Viewfinder			

## See Also

For information on reversing the exposure indicators so that negative values are displayed on the right and positive values on the left, see

 > Custom Setting f7 (**Reverse indicators**,  269).

## Long Time-Exposures (M Mode Only)

Select the following shutter speeds for long time-exposures of moving lights, the stars, night scenery, or fireworks.

- **Bulb** (Ⓛ Ⓛ Ⓛ): The shutter remains open while the shutter-release button is held down. To prevent blur, use a tripod or an optional wireless remote controller or remote cord (☐ 296).
- **Time** (- -): Start the exposure by using the shutter-release button on the camera, optional remote cord, or wireless remote controller. The shutter remains open until the button is pressed a second time.



Shutter speed: Ⓛ Ⓛ Ⓛ (35-second exposure)  
Aperture: f/25

### 1 Ready the camera.

Mount the camera on a tripod or place it on a stable, level surface.

#### Long Time-Exposures

Close the viewfinder eyepiece shutter to prevent the photograph being affected by light entering via the viewfinder (☐ 116). Nikon recommends using a fully charged battery or an optional AC adapter and power connector to prevent loss of power while the shutter is open. Note that noise (bright spots, randomly-spaced bright pixels or fog) may be present in long exposures. Bright spots and fog can be reduced by choosing **On** for **Long exposure NR** in the photo shooting menu (☐ 253).

---

## 2 Select exposure mode M.

Press the **MODE** button and rotate the main command dial until **M** is displayed in the control panel.

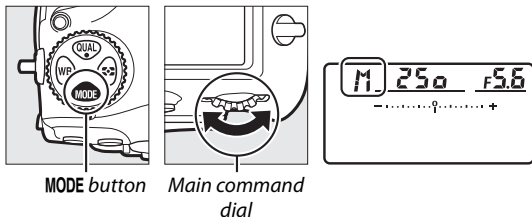

---

## 3 Choose a shutter speed.

While the exposure meters are on, rotate the main command dial to choose a shutter speed of Bulb (**b u l b**) or Time (**- -**). The exposure indicators do not appear when Bulb (**b u l b**) or Time (**- -**) is selected.

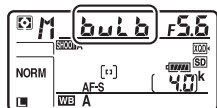

*Bulb*

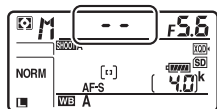

*Time*

---

## 4 Open the shutter.

**Bulb:** After focusing, press the shutter-release button on the camera or optional remote cord or wireless remote controller all the way down. Keep the shutter-release button pressed until the exposure is complete.

**Time:** Press the shutter-release button all the way down.

---

## 5 Close the shutter.

**Bulb:** Take your finger off the shutter-release button.

**Time:** Press the shutter-release button all the way down.



## Shutter-Speed and Aperture Lock

Shutter speed lock is available in shutter-priority auto and manual exposure modes, aperture lock in aperture-priority auto and manual exposure modes. Shutter speed and aperture lock are not available in programmed auto exposure mode.

- 1 Assign shutter speed and aperture lock to a camera control.**  
Assign **Shutter spd & aperture lock** to a control using Custom Setting f1 (**Custom control assignment**,  268).

- 2 Lock shutter speed and/or aperture.**

### Shutter speed (exposure modes S and M):

Press the selected control and rotate the main command dial until  icons appear in the viewfinder and control panel.



To unlock shutter speed, press the control and rotate the main command dial until the  icons disappear from the displays.

**Aperture (exposure modes A and M):** Press the selected control and rotate the sub-command dial until  icons appear in the viewfinder and the control panel.

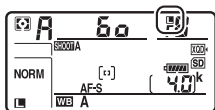
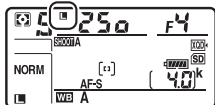
To unlock aperture, press the control and rotate the sub-command dial until the  icons disappear from the displays.



### See Also

For information on keeping shutter speed and/or aperture locked at the selected values, see  > Custom Setting f3 (**Shutter spd & aperture lock**;  268).



## Autoexposure (AE) Lock

Use autoexposure lock to recompose photographs after using center-weighted metering and spot metering (124) to meter exposure.

### 1 Lock exposure.

Position the subject in the selected focus point and press the shutter-release button halfway. With the shutter-release button pressed halfway and the subject positioned in the focus point, press the center of the sub-selector to lock exposure (if you are using autofocus, confirm that the ● in-focus indicator appears in the viewfinder).

Shutter-release button

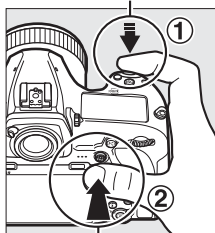

Sub-selector

While exposure lock is in effect, an **AE-L** indicator will appear in the viewfinder.



### 2 Recompose the photograph.

Keeping the center of the sub-selector pressed, recompose the photograph and shoot.



### Spot Metering

In spot metering, exposure will be locked at the value metered at the selected focus point (☞ 124).

### Adjusting Shutter Speed and Aperture

While exposure lock is in effect, the following settings can be adjusted without altering the metered value for exposure:

Exposure mode	Setting
P	Shutter speed and aperture (flexible program; ☞ 128)
S	Shutter speed
A	Aperture

The new values can be confirmed in the viewfinder and control panel. Note that the metering cannot be changed while exposure lock is in effect.

### See Also

For information on using the shutter-release button to lock exposure, see  > Custom Setting c1 (**Shutter-release button AE-L**, ☞ 263). If **On (half press)** is selected, exposure will lock when the shutter-release button is pressed halfway.

## Exposure Compensation

Exposure compensation is used to alter exposure from the value suggested by the camera, making pictures brighter or darker. It is most effective when used with center-weighted or spot metering (☐ 124). Choose from values between  $-5$  EV (underexposure) and  $+5$  EV (overexposure) in increments of  $\frac{1}{3}$  EV. In general, positive values make the subject brighter while negative values make it darker.



*-1 EV*



*No exposure  
compensation*



*+1 EV*

To choose a value for exposure compensation, press the  button and rotate the main command dial until the desired value is displayed in the viewfinder or control panel.

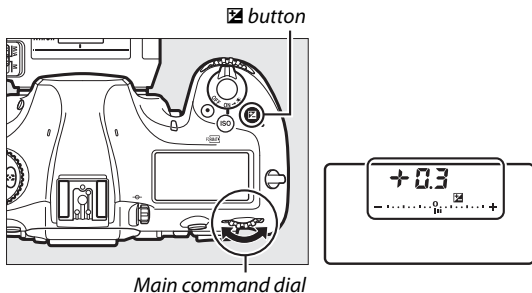

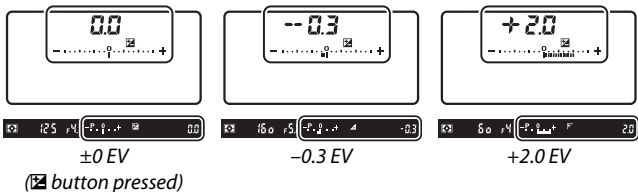

At values other than  $\pm 0.0$ , the 0 at the center of the exposure indicators will flash (except in exposure mode **M**) and a icon will be displayed in the viewfinder and control panel after you release the button. The current value for exposure compensation can be confirmed in the exposure indicator by pressing the button.

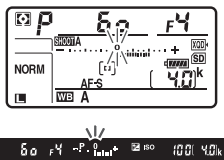

Normal exposure can be restored by setting exposure compensation to  $\pm 0.0$ . Exposure compensation is not reset when the camera is turned off.

### Exposure Mode M







In exposure mode **M**, exposure compensation affects only the exposure indicator; shutter speed and aperture do not change.

### Using a Flash

When a flash is used, exposure compensation affects both flash level and exposure, altering the brightness of both the main subject and the background. Custom Setting e3 (**Exposure comp. for flash**, 266) can be used to restrict the effects of exposure compensation to the background only.

### See Also

For information on:

- Choosing the size of the increments available for exposure compensation, see  > Custom Setting b3 (**Exp./flash comp. step value**,  262).
- Making adjustments to exposure compensation without pressing the  button, see  > Custom Setting b4 (**Easy exposure compensation**,  263).
- Automatically varying exposure, flash level, white balance, or Active D-Lighting, see “Bracketing” ( 142).

## Bracketing

Bracketing automatically varies exposure, flash level, **Active D-Lighting (ADL)**, or white balance slightly with each shot, “bracketing” the current value. Choose in situations in which getting the right settings is difficult and there is not time to check results and adjust settings with each shot, or to experiment with different settings for the same subject.

Bracketing is adjusted using the **Auto bracketing set** option in the photo shooting menu, which contains the following options:

- **AE & flash bracketing:** The camera varies exposure and flash level over a series of photographs (□ 143). Note that flash bracketing is available in i-TTL and, where supported, auto aperture (⊗A) flash control modes only (□ 189, 288).
- **AE bracketing:** The camera varies exposure over a series of photographs.
- **Flash bracketing:** The camera varies flash level over a series of photographs.
- **WB bracketing:** The camera creates multiple copies of each photograph, each with a different white balance (□ 148).
- **ADL bracketing:** The camera varies Active D-Lighting over a series of photographs (□ 152).

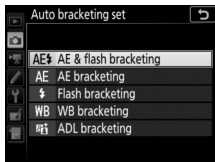

## ■ Exposure and Flash Bracketing

To vary exposure and/or flash level over a series of photographs:



Exposure modified by:  
0 EV



Exposure modified by:  
-1 EV



Exposure modified by:  
+1 EV

### 1 Choose the number of shots.

Pressing the **BKT** button, rotate the main command dial to choose the number of shots in the bracketing sequence. The number of shots is shown in the control panel.

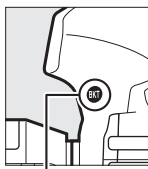

**BKT** button

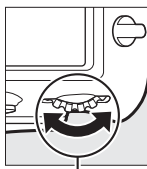

Main command  
dial

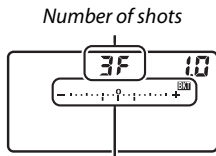

Number of shots  
Exposure and flash  
bracketing indicator

At settings other than zero, a **BKT** icon and exposure and flash bracketing indicator will appear in the control panel and **BKT** will be displayed in the viewfinder.



## 2 Select an exposure increment.

Pressing the **BKT** button, rotate the sub-command dial to choose the exposure increment.

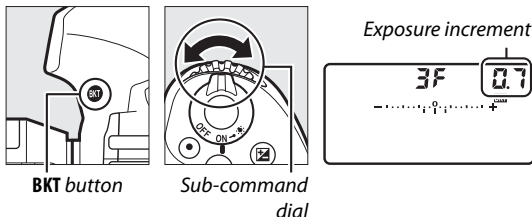

At default settings, the size of the increment can be chosen from 0.3 ( $\frac{1}{3}$ ), 0.7 ( $\frac{2}{3}$ ), 1, 2, and 3 EV. The bracketing programs with an increment of 0.3 ( $\frac{1}{3}$ ) EV are listed below.

Control panel display	No. of shots	Bracketing order (EVs)
0F 0.3 - ..... 0 ..... +	0	0
+ 3F 0.3 - ..... 0 ..... +	3	0/+0.3/+0.7
-- 3F 0.3 - ..... 0 ..... +	3	0/-0.7/-0.3
+ 2F 0.3 - ..... 0 ..... +	2	0/+0.3
-- 2F 0.3 - ..... 0 ..... +	2	0/-0.3
3F 0.3 - ..... 0 ..... +	3	0/-0.3/+0.3
5F 0.3 - ..... 0 ..... +	5	0/-0.7/-0.3/+0.3/+0.7
7F 0.3 - ..... 0 ..... +	7	0/-1.0/-0.7/-0.3/+0.3/ +0.7/+1.0
9F 0.3 - ..... 0 ..... +	9	0/-1.3/-1.0/-0.7/-0.3/ +0.3/+0.7/+1.0/+1.3

Note that for exposure increments of 2 EV or more, the maximum number of shots is 5; if a higher value was selected in Step 1, the number of shots will automatically be set to 5.



### 3 Frame a photograph, focus, and shoot.



The camera will vary exposure and/or flash level shot-by-shot according to the bracketing program selected. Modifications to exposure are added to those made with exposure compensation (📖 139).

While bracketing is in effect, a bracketing progress indicator will be displayed in the viewfinder and control panel. A segment will disappear from the indicator after each shot.

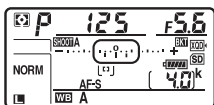

*No. shots: 3; increment: 0.7*

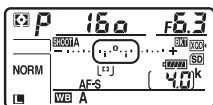





*Display after first shot*

## ■ ■ *Canceling Bracketing*

To cancel bracketing, press the **BKT** button and rotate the main command dial until the number of shots in the bracketing sequence is zero (0F) and **BKT** is no longer displayed. The program last in effect will be restored the next time bracketing is activated. Bracketing can also be cancelled by performing a two-button reset (☐ 209), although in this case the bracketing program will not be restored the next time bracketing is activated.

### See Also

For information on:

- Choosing the size of the increment, see  > Custom Setting b2 (**EV steps for exposure cntrl**, ☐ 262).
- Choosing the order in which bracketing is performed, see  > Custom Setting e7 (**Bracketing order**, ☐ 267).
- Choosing the role of the **BKT** button, see  > Custom Setting f1 (**Custom control assignment**) > **BKT button** +  (☐ 268).

### Exposure and Flash Bracketing

In continuous low speed, continuous high speed, and quiet continuous modes, shooting will pause after the number of shots specified in the bracketing program have been taken. Shooting will resume the next time the shutter-release button is pressed. In self-timer mode, the camera will take one shot each time the shutter-release button is pressed, regardless of the option selected for Custom Setting c3 (**Self-timer**) > **Number of shots** (□ 264); the interval between shots is however controlled by Custom Setting c3 (**Self-timer**) > **Interval between shots**. In other modes, one shot will be taken each time the shutter-release button is pressed.

If the memory card fills before all shots in the sequence have been taken, shooting can be resumed from the next shot in the sequence after the memory card has been replaced or shots have been deleted to make room on the memory card. If the camera is turned off before all shots in the sequence have been taken, bracketing will resume from the next shot in the sequence when the camera is turned on.

### Exposure Bracketing

The camera modifies exposure by varying shutter speed and aperture (programmed auto), aperture (shutter-priority auto), or shutter speed (aperture-priority auto, manual exposure mode). If **On** is selected for **ISO sensitivity settings** > **Auto ISO sensitivity control** (□ 121) in modes **P**, **S**, and **A**, the camera will automatically vary ISO sensitivity for optimum exposure when the limits of the camera exposure system are exceeded; in mode **M**, the camera will first use auto ISO sensitivity control to bring exposure as close as possible to the optimum and then bracket this exposure by varying shutter speed. Custom Setting e6 (**Auto bracketing (mode M)**, □ 267) can be used to change how the camera performs exposure and flash bracketing in manual exposure mode. Bracketing can be performed by varying flash level together with shutter speed and/or aperture, or by varying flash level alone.

## ■ White Balance Bracketing

The camera creates multiple copies of each photograph, each with a different white balance.

### 1 Choose the number of shots.

Pressing the **BKT** button, rotate the main command dial to choose the number of shots in the bracketing sequence. The number of shots is shown in the control panel.

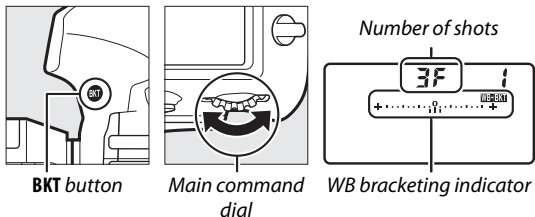

At settings other than zero, a **WB-BKT** icon and WB bracketing indicator will appear in the control panel and **BKT** will be displayed in the viewfinder.



## 2 Select a white balance increment.

Pressing the **BKT** button, rotate the sub-command dial to choose the white balance adjustment. Each increment is roughly equivalent to 5 mired.

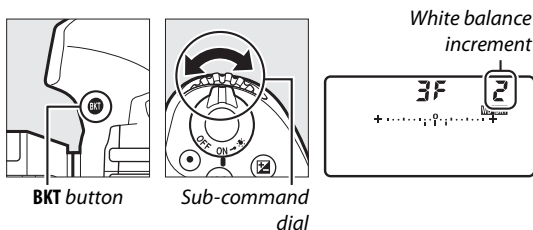

Choose from increments of 1 (5 mired), 2 (10 mired), or 3 (15 mired). Higher **B** values correspond to increased amounts of blue, higher **A** values to increased amounts of amber (□ 161). The bracketing programs with an increment of 1 are listed below.

Control panel display	No. of shots	White balance increment	Bracketing order
<b>0F</b> 1+..... <sup>o</sup> .....+	0	1	0
<b>b3F</b> 1+..... <sup>o</sup> .....+	3	1 B	0/1 B/2 B
<b>A3F</b> 1+..... <sup>o</sup> .....+	3	1 A	0/2 A/1 A
<b>b2F</b> 1+..... <sup>o</sup> .....+	2	1 B	0/1 B
<b>A2F</b> 1+..... <sup>o</sup> .....+	2	1 A	0/1 A
<b>3F</b> 1+..... <sup>o</sup> .....+	3	1 A, 1 B	0/1 A/1 B
<b>5F</b> 1+..... <sup>o</sup> .....+	5	1 A, 1 B	0/2 A/1 A/1 B/ 2 B
<b>7F</b> 1+..... <sup>o</sup> .....+	7	1 A, 1 B	0/3 A/2 A/1 A/ 1 B/2 B/3 B
<b>9F</b> 1+..... <sup>o</sup> .....+	9	1 A, 1 B	0/4 A/3 A/2 A/ 1 A/1 B/2 B/3 B/ 4 B

### 3 Frame a photograph, focus, and shoot.



Each shot will be processed to create the number of copies specified in the bracketing program, and each copy will have a different white balance. Modifications to white balance are added to the white balance adjustment made with white balance fine-tuning.

If the number of shots in the bracketing program is greater than the number of exposures remaining, **FuLL** and the icon for the affected card will flash in the control panel, a flashing **FuLL** icon will appear in the viewfinder, and the shutter release will be disabled.

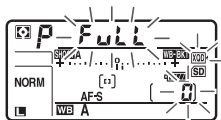

Shooting can begin when a new memory card is inserted.

## ■ ■ *Canceling Bracketing*

To cancel bracketing, press the **BKT** button and rotate the main command dial until the number of shots in the bracketing sequence is zero (0 F) and **WB-BKT** is no longer displayed. The program last in effect will be restored the next time bracketing is activated. Bracketing can also be cancelled by performing a two-button reset (☞ 209), although in this case the bracketing program will not be restored the next time bracketing is activated.

### 🔍 **White Balance Bracketing**

White balance bracketing is not available at an image quality of NEF (RAW). Selecting an NEF (RAW) or NEF (RAW) + JPEG option cancels white balance bracketing.

White balance bracketing affects only color temperature (the amber-blue axis in the white balance fine-tuning display, ☞ 161). No adjustments are made on the green-magenta axis.

In self-timer mode, the number of copies specified in the bracketing program will be created each time the shutter is released, regardless of the option selected for Custom Setting c3 (**Self-timer**) > **Number of shots** (☞ 264).

If the camera is turned off while the memory card access lamp is lit, the camera will power off only after all photographs in the sequence have been recorded.

## ■ ■ ADL Bracketing

The camera varies Active D-Lighting over a series of exposures.

### 1 Choose the number of shots.

Pressing the **BKT** button, rotate the main command dial to choose the number of shots in the bracketing sequence. The number of shots is shown in the control panel.

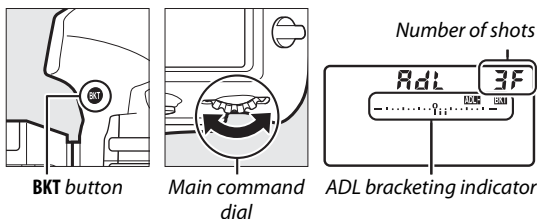

At settings other than zero, a **ADL-BKT** icon and an ADL bracketing indicator appear in the control panel and **BKT** will be displayed in the viewfinder. Choose two shots to take one photograph with Active D-Lighting off and another at a selected value. Choose three to five shots to take a series of photographs with Active D-Lighting set to **Off**, **Low**, and **Normal** (three shots), **Off**, **Low**, **Normal**, and **High** (four shots), or **Off**, **Low**, **Normal**, **High**, and **Extra high** (five shots). If you choose more than two shots, proceed to Step 3.



## 2 Select Active D-Lighting.

Pressing the **BKT** button, rotate the sub-command dial to choose Active D-Lighting.

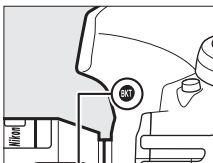

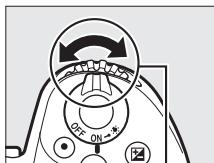

**BKT** button



*Sub-command dial*

Active D-Lighting is shown in the control panel.

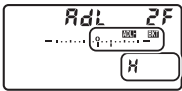
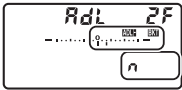
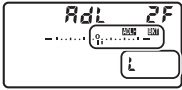
Control panel display	ADL
	暗A Auto
	暗H* Extra high
	暗H High
	暗N Normal
	暗L Low

### 3 Frame a photograph, focus, and shoot.



The camera will vary Active D-Lighting shot-by-shot according to the bracketing program selected. While bracketing is in effect, a bracketing progress indicator will be displayed in the control panel. A segment will disappear from the indicator after each shot.

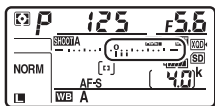

*No. shots: 3*

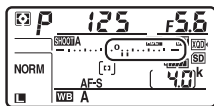

*Display after first shot*

## ■ ■ *Canceling Bracketing*

To cancel bracketing, press the **BKT** button and rotate the main command dial until the number of shots in the bracketing sequence is zero (0F) and **ADL-BKT** is no longer displayed. The program last in effect will be restored the next time bracketing is activated. Bracketing can also be cancelled by performing a two-button reset (☞ 209), although in this case the bracketing program will not be restored the next time bracketing is activated.

### 🔪 **ADL Bracketing**



In continuous low speed, continuous high speed, and quiet continuous modes, shooting will pause after the number of shots specified in the bracketing program have been taken. Shooting will resume the next time the shutter-release button is pressed. In self-timer mode, the camera will take one shot each time the shutter-release button is pressed, regardless of the option selected for Custom Setting c3 (**Self-timer**) > **Number of shots** (☞ 264); the interval between shots is however controlled by Custom Setting c3 (**Self-timer**) > **Interval between shots**. In other modes, one shot will be taken each time the shutter-release button is pressed.







If the memory card fills before all shots in the sequence have been taken, shooting can be resumed from the next shot in the sequence after the memory card has been replaced or shots have been deleted to make room on the memory card. If the camera is turned off before all shots in the sequence have been taken, bracketing will resume from the next shot in the sequence when the camera is turned on.

# White Balance

## White Balance Options

White balance ensures that colors are unaffected by the color of the light source. Auto white balance is recommended with most light sources. If the desired results cannot be achieved with auto white balance, choose an option from the list below or use preset white balance.

Option (Color temp. °)	Description
<b>AUTO Auto</b>	White balance is adjusted automatically for optimal results with most light sources. For best results, use type G, E or D lens. If optional flash fires, results are adjusted appropriately. Color temperature can be viewed in the playback info display after shooting (📖 229).
<b>Keep white (reduce warm colors; 3500–8000 K)</b>	
<b>Normal (3500–8000 K)</b>	
<b>Keep warm lighting colors (3500–8000 K)</b>	
 <b>A Natural light auto (4500–8000 K)</b>	White balance is adjusted for natural light, producing colors closer to those seen by the naked eye.
 <b>Incandescent (3000 K)</b>	Use under incandescent lighting.

Option (Color temp.°)	Description
 <b>Fluorescent</b> <b>Sodium-vapor lamps</b> (2700 K) <b>Warm-white fluorescent</b> (3000 K) <b>White fluorescent</b> (3700 K) <b>Cool-white fluorescent</b> (4200 K) <b>Day white fluorescent</b> (5000 K) <b>Daylight fluorescent</b> (6500 K) <b>High temp. mercury-vapor</b> (7200 K)	Use with: <ul style="list-style-type: none"> <li>• Sodium-vapor lighting (found in sports venues).</li> <li>• Warm-white fluorescent lights.</li> <li>• White fluorescent lights.</li> <li>• Cool-white fluorescent lights.</li> <li>• Daylight white fluorescent lights.</li> <li>• Daylight fluorescent lights.</li> <li>• High color temperature light sources (e.g. mercury-vapor lamps).</li> </ul>
 <b>Direct sunlight</b> (5200 K)	Use with subjects lit by direct sunlight.
 <b>Flash</b> (5400 K)	Use with optional flash units.
 <b>Cloudy</b> (6000 K)	Use in daylight under overcast skies.
 <b>Shade</b> (8000 K)	Use in daylight with subjects in the shade.
 <b>Choose color temp.</b> (2500–10,000 K)	Choose color temperature from list of values (☞ 163).
<b>PRE Preset manual</b>	Use subject, light source, or existing photograph as reference for white balance (☞ 165).

\* All values are approximate and do not reflect fine-tuning (if applicable).

White balance can be selected by pressing the **WB** button and rotating the main command dial until the desired setting is displayed in the control panel.

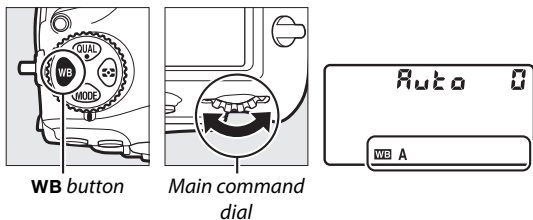

When **AUTO (Auto)** or  (**Fluorescent**) is selected, you can choose a sub-option by pressing the **WB** button and rotating the sub-command dial.

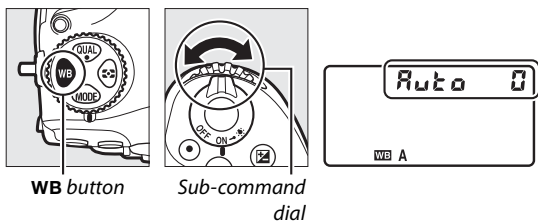

### 🔍 The Shooting Menus

White balance can also be adjusted using the **White balance** option in the photo or movie shooting menu (☐ 252, 257), which also can be used to fine-tune white balance (☐ 161) or manage white-balance presets (☐ 165).

### 🔍 AUTO (“Auto”)

AUTO (**Auto**) offers a choice of AUTO0 (**Keep white (reduce warm colors)**), AUTO1 (**Normal**), and AUTO2 (**Keep warm lighting colors**).

AUTO0 (**Keep white (reduce warm colors)**) makes whites recorded under incandescent lighting appear white, while AUTO2 (**Keep warm lighting colors**) preserves the warm tints we normally perceive under incandescent lighting.

### 🔍 ☀️A (“Natural Light Auto”)

☀️A (**Natural light auto**) may not produce the desired results under artificial light. Choose AUTO (**Auto**) or an option that matches the light source.

### 🔍 Studio Flash Lighting

AUTO (**Auto**) may not produce the desired results with large studio flash units. Use preset white balance or set white balance to ⚡ (**Flash**) and use fine-tuning to adjust white balance.

### 🔍 See Also

For information on varying white balance to “bracket” the current value, see “Bracketing” (☐ 142).









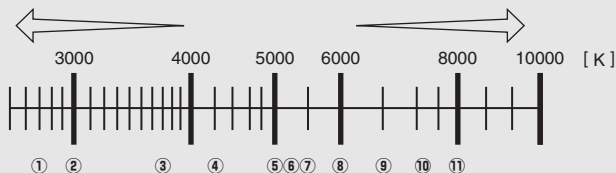



## Color Temperature

The perceived color of a light source varies with the viewer and other conditions. Color temperature is an objective measure of the color of a light source, defined with reference to the temperature to which an object would have to be heated to radiate light in the same wavelengths. While light sources with a color temperature in the neighborhood of 5000–5500 K appear white, light sources with a lower color temperature, such as incandescent light bulbs, appear slightly yellow or red. Light sources with a higher color temperature appear tinged with blue.

*"Warmer" (redder) colors*

*"Cooler" (bluer) colors*



①	 (sodium-vapor lamps): 2700 K
②	 (incandescent)/  (warm-white fluorescent.): 3000 K
③	 (white fluorescent): 3700 K
④	 (cool-white fluorescent): 4200 K
⑤	 (day white fluorescent): 5000 K
⑥	 (direct sunlight): 5200 K
⑦	 (flash): 5400 K
⑧	 (cloudy): 6000 K
⑨	 (daylight fluorescent): 6500 K
⑩	 (high temp. mercury-vapor): 7200 K
⑪	 (shade): 8000 K

**Note:** All figures are approximate.



## Fine-Tuning White Balance

At settings other than **☑ (Choose color temp.)**, white balance can be “fine-tuned” to compensate for variations in the color of the light source or to introduce a deliberate color cast into an image.

### 1 Display fine-tuning options.

Highlight a white balance option and press **⏏** (if a sub-menu is displayed, select the desired option and press **⏏** again to display fine-tuning options; for information on fine-tuning preset manual white balance, see “Fine-Tuning Preset Manual White Balance”, **174**).

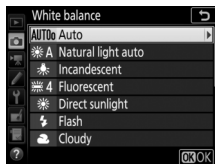

### 2 Fine-tune white balance.

Use the multi selector to fine-tune white balance. White balance can be fine-tuned on the amber (A)–blue (B) axis in steps of 0.5 and the green (G)–magenta (M) axis in steps of 0.25. The horizontal (amber-blue) axis corresponds to color temperature, while the vertical (green-magenta) axis has the similar effects to the corresponding color compensation (CC) filters. The horizontal axis is ruled in increments equivalent to about 5 mired, the vertical axis in increments of about 0.05 diffuse density units.

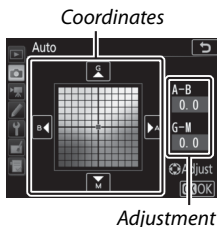

### 3 Press **OK**.

Press **OK** to save settings and return to the photo shooting menu. If white balance has been fine-tuned, an asterisk (“\*”) will be displayed in the control panel.

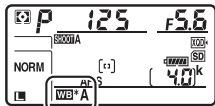

#### **Fine-Tuning in Live View**

To fine-tune white balance during live view, hold the **WB** button while using the multi selector. Press **←** or **→** for Amber–Blue and **↑** or **↓** for Green–Magenta.

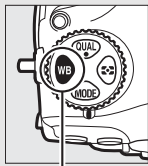

**WB** button



#### **White Balance Fine-Tuning**

The colors on the fine-tuning axes are relative, not absolute. For example, moving the cursor to **B** (blue) when a “warm” setting such as **☀** (**Incandescent**) is selected for white balance will make photographs slightly “colder” but will not actually make them blue.

#### **“Mired”**

Any given change in color temperature produces a greater difference in color at low color temperatures than it would at higher color temperatures. For example, a change of 1000 K produces a much greater change in color at 3000 K than at 6000 K. Mired, calculated by multiplying the inverse of the color temperature by  $10^6$ , is a measure of color temperature that takes such variation into account, and as such is the unit used in color-temperature compensation filters. E.g.:

- 4000 K–3000 K (a difference of 1000 K)=83 mired
- 7000 K–6000 K (a difference of 1000 K)=24 mired

## Choosing a Color Temperature

Follow the steps below to choose a color temperature when **☑ (Choose color temp.)** is selected for white balance.

### ☑ Choose Color Temperature

Note that the desired results will not be obtained with flash or fluorescent lighting. Choose **⚡ (Flash)** or **☀ (Fluorescent)** for these sources. With other light sources, take a test shot to determine if the selected value is appropriate.

### ■ The White Balance Menu

Color temperature can be selected using the **White balance** options in the photo shooting menu. Enter values for the amber–blue and green–magenta axes as described below.

#### 1 Select Choose color temp.

Select **White balance** in the photo shooting menu, then highlight **Choose color temp.** and press **⏏**.

#### 2 Select values for amber–blue and green–magenta.

Press **⏏** or **⏏** to highlight digits on the amber (A)–blue (B) axis or the green (G)–magenta (M) axis and press **⏏** or **⏏** to change.

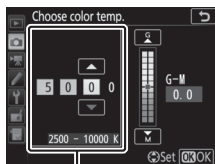

Value for amber (A)-  
blue (B) axis

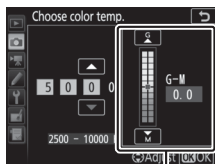

Value for green (G)-  
magenta (M) axis

### 3 Press **OK**.

Press **OK** to save changes and return to the photo shooting menu. If a value other than 0 is selected for the green (G)–magenta (M) axis, an asterisk (“\*”) will be displayed in the control panel.

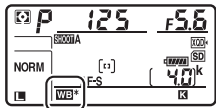

### ■ The WB Button

When **[WB]** (**Choose color temp.**) is selected, the **WB** button can be used to select the color temperature, although only for the amber (A)–blue (B) axis. Press the **WB** button and rotate the sub-command dial until the desired value is displayed in the control panel (adjustments are made in mireds; [162](#)). To enter a color temperature directly, press the **WB** button and press **←** or **→** to highlight a digit and press **▲** or **▼** to change.

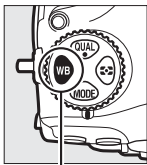

**WB** button

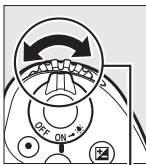

Sub-command dial



## Preset Manual

Preset manual is used to record and recall custom white balance settings for shooting under mixed lighting or to compensate for light sources with a strong color cast. The camera can store up to six values for preset white balance in presets d-1 through d-6. Two methods are available for setting preset white balance:

Method	Description
<b>Direct measurement</b>	Neutral gray or white object is placed under lighting that will be used in final photograph and white balance is measured by camera (☐ 166). During live view (☐ 37, 59), white balance can be measured in a selected area of the frame (spot white balance, ☐ 169).
<b>Copy from existing photograph</b>	White balance is copied from photo on memory card (☐ 172).

### White Balance Presets

Changes to white balance presets apply to all photo shooting menu banks (☐ 250).

## Viewfinder Photography

### **1** Light a reference object.

Place a neutral gray or white object under the lighting that will be used in the final photograph. In studio settings, a standard gray panel can be used as a reference object. Note that exposure is automatically increased by 1 EV when measuring white balance; in exposure mode **M**, adjust exposure so that the exposure indicator shows  $\pm 0$  (📖 132).

### **2** Set white balance to **PRE** (Preset manual).

Press the **WB** button and rotate the main command dial until **PRE** is displayed in the control panel.

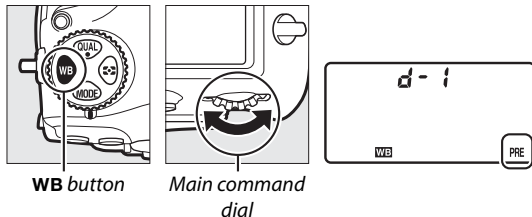

#### **🔍 Measuring Preset Manual White Balance (Viewfinder Photography)**

Preset manual white balance cannot be measured during time-lapse movie recording or while you are shooting an HDR photograph or multiple exposure.

### 3 Select a preset.

Press the **WB** button and rotate the sub-command dial until the desired white balance preset (d-1 to d-6) is displayed in the control panel.

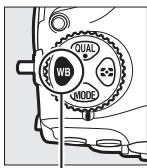

**WB** button

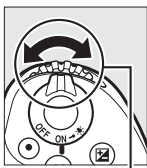

Sub-command  
dial

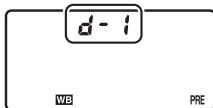

### 4 Select direct measurement mode.

Release the **WB** button briefly and then press the button until the **PRE** icon in the control panel starts to flash. A flashing **P-E** will also appear in the viewfinder.

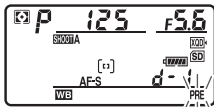

### 5 Measure white balance.

In the few seconds before the indicators stop flashing, frame the reference object so that it fills the viewfinder and press the shutter-release button all the way down. The camera will measure a value for white balance and store it in the preset selected in Step 3. No photograph will be recorded; white balance can be measured accurately even when the camera is not in focus.



## 6 Check the results.

If the camera was able to measure a value for white balance, **Good** will flash in the control panel, while the viewfinder will show a flashing **Good**. Press the shutter-release button halfway to exit to shooting mode.



If lighting is too dark or too bright, the camera may be unable to measure white balance. A flashing **no Good** will appear in the control panel and viewfinder. Press the shutter-release button halfway to return to Step 5 and measure white balance again.

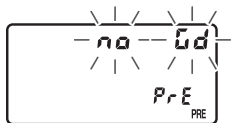

### Direct Measurement Mode

If no operations are performed during viewfinder photography while the displays are flashing, direct measurement mode will end in the time selected for Custom Setting c2 (**Standby timer**, 263).

### Protected Presets

If the current preset is protected (174), **PrE** will flash in the control panel and viewfinder if you attempt to measure a new value.

### Selecting a Preset

Selecting **Preset manual** for the **White balance** option in the photo shooting menu displays white balance presets; highlight a preset and press **OK**. If no value currently exists for the selected preset, white balance will be set to 5200 K, the same as **Direct sunlight**.





## **Live View (Spot White Balance)**

During live view (☞ 37, 59), white balance can be measured in a selected area of the frame, eliminating the need to prepare a reference object or change lenses during telephoto photography.

---

### **1 Press the **Lv** button.**

The mirror will be raised and the view through the lens will be displayed in the camera monitor.

---

### **2 Set white balance to PRE (Preset manual).**

Press the **WB** button and rotate the main command dial until **PRE** is displayed in the monitor.

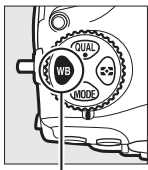

**WB button**

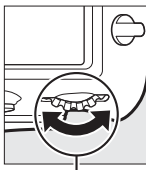

*Main command  
dial*



### 3 Select a preset.

Press the **WB** button and rotate the sub-command dial until the desired white balance preset (d-1 to d-6) is displayed in the monitor.

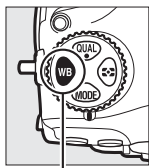

**WB** button

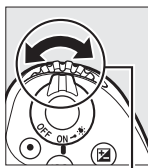

*Sub-command dial*



### 4 Select direct measurement mode.

Release the **WB** button briefly and then press the button until the **PRE** icon in the monitor starts to flash. A spot white balance target (□) will be displayed at the selected focus point.



### 5 Position the target over a white or grey area.

While **PRE** flashes in the display, use the multi selector to position the □ over a white or grey area of the subject. To zoom the area around the target in for more precise positioning, press the  button. You can also measure white balance anywhere in the frame by tapping your subject in the monitor, in which case there is no need to press the center of the multi selector or the shutter-release button as described in Step 6.



## 6 Measure white balance.

Press the center of the multi selector or press the shutter-release button all the way down to measure white balance. The time available to measure white balance is that selected for Custom Setting c4 (**Monitor off delay**) > **Live view** (☞ 264).

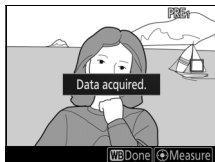

If the camera is unable to measure white balance, a message will be displayed. Choose a new white balance target and repeat the process from Step 5.



## 7 Exit direct measurement mode.

Press the **WB** button to exit direct measurement mode.

White balance presets can be viewed by selecting **Preset manual** for **White balance** in the photo or movie shooting menu. The position of the targets used to measure preset white balance is displayed on presets recorded during live view.



### Measuring Preset Manual White Balance (Live View)

Preset manual white balance cannot be measured while an HDR exposure is in progress (☞ 182) or when **None** is selected for **Photo live view display WB** in the **i**-button menu (☞ 45).

## Managing Presets

### ■ Copying White Balance from a Photograph

Follow the steps below to copy a value for white balance from an existing photograph to a selected preset.

- 1 Select Preset manual.**  
Select **White balance** in the photo shooting menu, then highlight **Preset manual** and press .

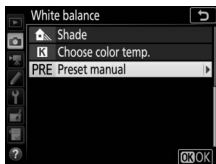

- 2 Select a destination.**  
Highlight the destination preset (d-1 to d-6) and press the center of the multi selector.





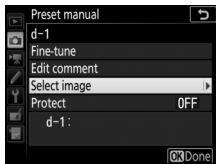

- 3 Choose Select image.**  
Highlight **Select image** and press .



---

## 4 Highlight a source image.

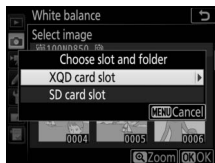

Highlight the source image. To view the highlighted image full frame, press and hold the  button.

To view images in other locations, press  () and select the desired card and folder ( 224).



---

## 5 Copy white balance.

Press  to copy the white balance value for the highlighted photograph to the selected preset. If the highlighted photograph has a comment ( 273), the comment will be copied to the comment for the selected preset.

### Fine-Tuning Preset White Balance

The selected preset can be fine-tuned by selecting **Fine-tune** and adjusting white balance as described in “Fine-Tuning White Balance” (📖 161).

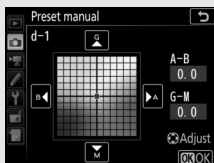

### Edit Comment

To enter a descriptive comment of up to 36 characters for the current white-balance preset, select **Edit comment** in the preset manual white balance menu and enter a comment (📖 273).



### Protect

To protect the current white-balance preset, select **Protect** in the preset manual white balance menu, then highlight **On** and press **OK**. Protected presets cannot be modified and the **Fine-tune** and **Edit comment** options cannot be used.

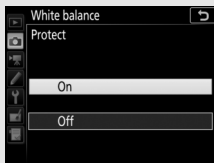









# Image Enhancement

## Picture Controls

### Selecting a Picture Control

Choose a Picture Control according to the subject or type of scene.

Option	Description
 <b>A Auto</b>	The camera automatically adjusts hues and tones based on the <b>Standard</b> Picture Control. The complexions of portrait subjects will appear softer, and such elements as the foliage and sky in outdoor shots more vivid, than in pictures taken with the <b>Standard</b> Picture Control.
 <b>SD Standard</b>	Standard processing for balanced results. Recommended for most situations.
 <b>NL Neutral</b>	Minimal processing for natural results. Choose for photographs that will later be processed or retouched.
 <b>VI Vivid</b>	Pictures are enhanced for a vivid, photoprint effect. Choose for photographs that emphasize primary colors.
 <b>MC Monochrome</b>	Take monochrome photographs.
 <b>PT Portrait</b>	Process portraits for skin with natural texture and a rounded feel.
 <b>LS Landscape</b>	Produces vibrant landscapes and cityscapes.
 <b>FL Flat</b>	Details are preserved over a wide tone range, from highlights to shadows. Choose for photographs that will later be extensively processed or retouched.

- 1** Press **Q** (**Q/?**).  
A list of Picture Controls will be displayed.

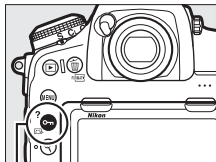

**Q** (**Q/?**) button

- 2** Select a Picture Control.  
Highlight the desired Picture Control and press **OK**.

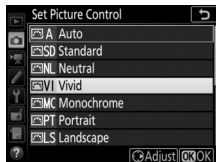

### Custom Picture Controls

Custom Picture Controls are created through modifications to existing Picture Controls using the **Manage Picture Control** option in the photo or movie shooting menu (252, 258). Custom Picture Controls can be saved to a memory card for sharing among other cameras of the same model and compatible software.

### The Picture Control Indicator

The current Picture Control is shown in the information display when the **info** button is pressed.

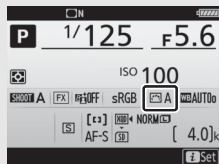

### The Shooting Menus

Picture Controls can also be selected using the **Set Picture Control** option in the photo or movie shooting menu (252, 257).



## Modifying Picture Controls

Existing preset or custom Picture Controls (📖 176) can be modified to suit the scene or the user's creative intent. Choose a balanced combination of settings using **Quick adjust**, or make manual adjustments to individual settings.

### 1 Select a Picture Control.

Highlight the desired Picture Control in the Picture Control list (📖 175) and press **OK**.

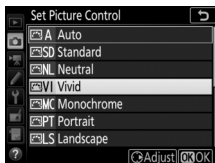

### 2 Adjust settings.

Press **Up** or **Down** to highlight the desired setting and press **Left** or **Right** to choose a value in increments of 1, or rotate the sub-command dial to choose a value in increments of 0.25 (📖 178; the options available vary with the Picture Control selected). Repeat this step until all settings have been adjusted, or select a preset combination of settings by highlighting **Quick adjust** and pressing **Up** or **Down**. Default settings can be restored by pressing the **Reset** (🗑️) button.



### 3 Press **OK**.

#### 📌 Modifications to Original Picture Controls

Picture Controls that have been modified from default settings are indicated by an asterisk ("\*") in the **Set Picture Control** menu.

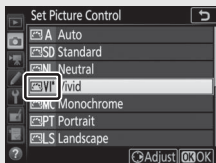

## Picture Control Settings

Option	Description	
<b>Quick adjust</b>	Mute or heighten the effect of the selected Picture Control (note that this resets all manual adjustments). Not available with custom Picture Controls (□ 176).	
<b>Manual adjustments</b>	<b>Sharpening</b>	Control the sharpness of outlines. Select <b>A</b> to adjust sharpening automatically according to the type of scene.
	<b>Clarity</b>	Adjust clarity manually or select <b>A</b> to let the camera adjust clarity automatically. Depending on the scene, shadows may appear around bright objects or halos may appear around dark objects at some settings. Clarity is not applied to movies.
	<b>Contrast</b>	Adjust contrast manually or select <b>A</b> to let the camera adjust contrast automatically.
	<b>Brightness</b>	Raise or lower brightness without loss of detail in highlights or shadows.
	<b>Saturation</b>	Control the vividness of colors. Select <b>A</b> to adjust saturation automatically according to the type of scene.
	<b>Hue</b>	Adjust hue.
	<b>Filter effects</b>	Simulate the effect of color filters on monochrome photographs (□ 179).
	<b>Toning</b>	Choose the tint used in monochrome photographs (□ 179).

### The "A Auto" Picture Control

If  **A Auto** is selected for **Set Picture Control**, settings can be adjusted in the range **A-2** to **A+2**. Rotating the sub-command dial has no effect.

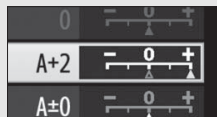

### "A" (Auto)

Results for auto sharpening, clarity, contrast, and saturation vary with exposure and the position of the subject in the frame. Use a type G, E, or D lens for best results.

### Switching Between Manual and Auto

Press the **Q** button to switch back and forth between manual and auto (A) settings for sharpening, clarity, contrast, and saturation.

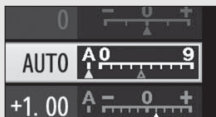

### Previous Settings

The **Δ** indicator under the value display in the Picture Control setting menu indicates the previous value for the setting. Use this as a reference when adjusting settings.



### Filter Effects (Monochrome Only)

The options in this menu simulate the effect of color filters on monochrome photographs. The following filter effects are available:

Option	Description	
Y	Yellow	Enhances contrast. Can be used to tone down the brightness of the sky in landscape photographs.
O	Orange	Orange produces more contrast than yellow, red more contrast than orange.
R	Red	
G	Green	Softens skin tones. Can be used for portraits.

### Toning (Monochrome Only)

Pressing **Q** when **Toning** is selected displays saturation options. Press **←** or **→** to adjust saturation. Saturation control is not available when **B&W** (black-and-white) is selected.



### Touch Controls

Tapping the indicator displays touch controls that can be used to adjust Picture Control settings.



## Preserving Detail in Highlights and Shadows

### Active D-Lighting

Active D-Lighting preserves details in highlights and shadows, creating photographs with natural contrast. Use for high contrast scenes, for example when photographing brightly lit outdoor scenery through a door or window or taking pictures of shaded subjects on a sunny day. It is most effective when used with matrix metering (📖 124).



*Active D-Lighting off*



*Active D-Lighting: 𠄎 A Auto*

### "Active D-Lighting" versus "D-Lighting"

The **Active D-Lighting** options in the photo and movie shooting menus adjust exposure before shooting to optimize the dynamic range, while the **D-Lighting** option in the retouch menu (📖 278) brightens shadows in images after shooting.

### **Active D-Lighting**

Noise (randomly-spaced bright pixels, fog, or lines) may appear in photographs taken with Active D-Lighting. Uneven shading may be visible with some subjects. Active D-Lighting does not apply at high ISO sensitivities (Hi 0.3–Hi 2).



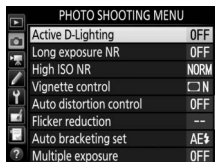

To use Active D-Lighting:

## 1 Select Active D-Lighting.

Highlight **Active D-Lighting** in the photo shooting menu and press .



## 2 Choose an option.

Highlight the desired option and press . If  **Auto** is selected, the camera will automatically adjust Active D-Lighting according to shooting conditions (in exposure mode **M**, however,  **Auto** is equivalent to  **Normal**).

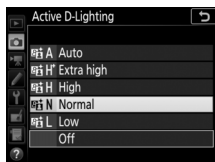

### Active D-Lighting and Movies

If **Same as photo settings** is selected for **Active D-Lighting** in the movie shooting menu and **Auto** is selected in the photo shooting menu, movies will be shot at a setting equivalent to **Normal**. Active D-Lighting does not apply at frame sizes of 1920 × 1080 (slow-mo) and 3840 × 2160.

### See Also

For information on varying Active D-Lighting over a series of shots, see “Bracketing” (□ 142).

## High Dynamic Range (HDR)

Used with high-contrast subjects, High Dynamic Range (HDR) preserves details in highlights and shadows by combining two shots taken at different exposures. HDR is most effective when used with matrix metering (☞ 124; with spot or center-weighted metering and a non-CPU lens, an exposure differential of **Auto** is equivalent to about 2 EV). It cannot be combined with some camera features, including NEF (RAW) recording, flash lighting (☞ 187), bracketing (☞ 142), multiple exposure, focus shift, time lapse, and shutter speeds of  $\frac{1}{250}$  and  $\frac{1}{500}$ .



First exposure (darker)

+



Second exposure  
(brighter)

→



Combined HDR image

- Select HDR (high dynamic range).** Highlight **HDR (high dynamic range)** in the photo shooting menu and press

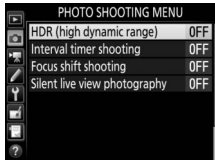

## 2 Select a mode.

Highlight **HDR mode** and press .

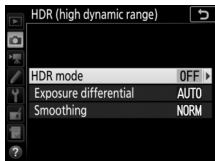

Highlight one of the following and press .

- **To take a series of HDR photographs**, select **ON On (series)**. HDR shooting will continue until you select **Off** for **HDR mode**.
- **To take one HDR photograph**, select **On (single photo)**. Normal shooting will resume automatically after you have created a single HDR photograph.
- **To exit without creating additional HDR photographs**, select **Off**.

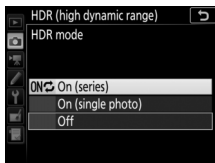

If **On (series)** or **On (single photo)** is selected, a  icon will be displayed in the control panel.

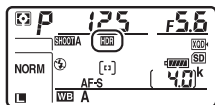

---

### 3 Choose the exposure differential.

To choose the difference in exposure between the two shots, highlight **Exposure differential** and press .

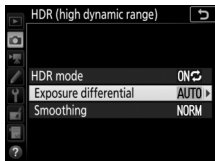

Exposure differential options will be displayed. Highlight an option and press . Choose higher values for high-contrast subjects, but note that choosing a value higher than required may not produce the desired results; if

**Auto** is selected, the camera will automatically adjust exposure to suit the scene.

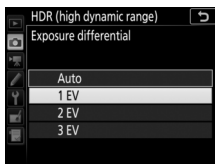

---

### 4 Choose the amount of smoothing.

To choose how much the boundaries between the two images are smoothed, highlight **Smoothing** and press .

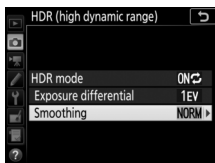

Smoothing options will be displayed. Highlight an option and press . Higher values produce a smoother composite image. Uneven shading may be visible with some subjects.





## 5 Frame a photograph, focus, and shoot.

The camera takes two exposures when the shutter-release button is pressed all the way down.

"Job HDR" will flash in the control panel and Job Hdr in the viewfinder while the images are combined; no photographs can be taken until recording is complete.

Regardless of the option currently selected for release mode, only one photograph will be taken each time the shutter-release button is pressed.



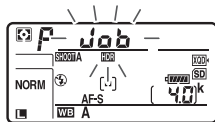





If **On (series)** is selected, HDR will only turn off when **Off** is selected for **HDR mode**; if **On (single photo)** is selected, HDR turns off automatically after the photograph is taken. The HDR icon clears from the display when HDR shooting ends.



### Framing HDR Photographs

The edges of the image will be cropped out. The desired results may not be achieved if the camera or subject moves during shooting. Use of a tripod is recommended. Depending on the scene, shadows may appear around bright objects or halos may appear around dark objects; this effect can be reduced by adjusting the amount of smoothing.

### The BKT Button

If **HDR (high dynamic range)** is selected for Custom Setting f1 (**Custom control assignment**) > **BKT button** +  (□ 268), you can select the HDR mode by pressing the **BKT** button and rotating the main command dial and the exposure differential by pressing the **BKT** button and rotating the sub-command dial. The mode and exposure differential are shown in the control panel: the icons representing the mode are  **FF** for **Off**,  for **On (single photo)**, and  for **On (series)**, while the icons for exposure differential are respectively , , , and  for **1 EV**, **2 EV**, **3 EV**, and **Auto**.

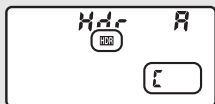

### Interval Timer Photography

If **On (series)** is selected for **HDR mode** before interval timer shooting begins, the camera will continue to shoot HDR photographs at the selected interval (if **On (single photo)** is selected, interval timer shooting will end after a single shot).

### Photo Shooting Menu Banks

HDR settings can be adjusted separately for each bank (□ 250), but switching to a bank in which HDR is active during multiple exposure or interval timer shooting disables HDR. HDR is also disabled if you switch to a bank in which an NEF (RAW) option is selected for image quality.

# Optional Flash Units

To take photos with a flash, attach an optional flash unit (📖 288) to the camera accessory shoe. For information on using flash units, see the documentation provided with the device. Information on using multiple remote flash units may be found in a *Menu Guide* available on Nikon websites (📖 i).

## Using a Flash

Follow the steps below to mount an optional flash unit on the camera and take photographs using the flash.

---

### 1 Mount the unit on the accessory shoe.

See the manual provided with the unit for details.

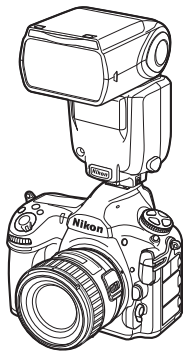

---

### 2 Turn on the camera and flash unit.

The flash will begin charging; the flash-ready indicator (⚡) will be displayed in the viewfinder when charging is complete.

### 3 Adjust flash settings.

Choose the flash mode (☞ 192) and flash control mode (☞ 190).

### 4 Adjust shutter speed and aperture.

### 5 Take pictures.

#### ✔ Use Only Nikon Flash Accessories

*Use only Nikon flash units.* Negative voltages or voltages over 250 V applied to the accessory shoe could not only prevent normal operation, but damage the sync circuitry of the camera or flash. Before using a Nikon flash unit not listed in this section, contact a Nikon-authorized service representative for more information.

#### ✎ Shutter Speed

Shutter speed can be set as follows when an optional flash unit is used:

Mode	Shutter speed
P, A	Set automatically by camera ( $1/250$ s– $1/60$ s)*
S	Value selected by user ( $1/250$ s–30 s)
M	Value selected by user ( $1/250$ s–30 s, Bulb (b u l b), Time (- -))

\* Shutter speed may be set as slow as 30 s if slow sync, slow rear-curtain sync, or slow sync with red-eye reduction is selected for flash mode.

#### ✎ The Sync Terminal

A sync cable can be connected to the sync terminal as required. Do not connect another flash unit via a sync cable when performing rear-curtain sync flash photography with a flash unit mounted on the camera accessory shoe.



### i-TTL Flash Control

When a CLS-compatible flash unit is set to TTL, the camera automatically selects one of the following types of flash control:

- **i-TTL balanced fill-flash for digital SLR:** Flash unit emits series of nearly invisible preflashes (monitor preflashes) immediately before main flash. Preflashes reflected from objects in all areas of frame are picked up by RGB sensor with approximately 180K (180,000) pixels and are analyzed in combination with range information from matrix metering system to adjust flash output for natural balance between main subject and ambient background lighting. If type G, E, or D lens is used, distance information is included when calculating flash output. Precision of calculation can be increased for non-CPU lenses by providing lens data (focal length and maximum aperture;  218). Not available when spot metering is used.
- **Standard i-TTL fill-flash for digital SLR:** Flash output adjusted to bring lighting in frame to standard level; brightness of background is not taken into account. Recommended for shots in which main subject is emphasized at expense of background details, or when exposure compensation is used. Standard i-TTL fill-flash for digital SLR is activated automatically when spot metering is selected.



## On-Camera Flash Photography

When a flash unit that supports unified flash control (an SB-5000, SB-500, SB-400, or SB-300) is mounted on the camera, the flash control mode, flash level, and other flash settings can be adjusted using the

### Flash control > Flash control mode

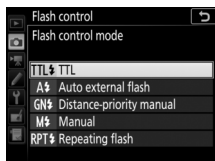
item in the photo shooting menu (in the case of the SB-5000, these settings can also be adjusted using the controls on the flash unit). The options available vary with the flash used (☞ 288), while the options displayed under **Flash control mode** vary with the mode selected. Settings for other flash units can only be adjusted using flash unit controls.



- **TTL:** i-TTL mode. In the cases of the SB-500, SB-400, and SB-300, flash compensation can be adjusted using the  button (☞ 194).
- **Auto external flash:** In this mode, output is adjusted automatically according to the amount of light reflected by the subject; flash compensation is also available. Auto external flash supports “auto aperture” (A) and “non-TTL auto” (A) modes; non-TTL auto is selected automatically if a non-CPU lens is attached without specifying the focal length and maximum aperture using the **Non-CPU lens data** option in the setup menu (☞ 218). See the flash unit manual for details.
- **Distance-priority manual:** Choose the distance to the subject; flash output will be adjusted automatically. Flash compensation is also available.







- **Manual:** Choose the flash level manually.
- **Repeating flash:** The flash fires repeatedly while the shutter is open, producing a multiple-exposure effect. Choose the flash level (**Output**), the maximum number of times the unit fires (**Times**), and the number of times the flash fires per second (**Frequency**, measured in Hertz). The options available for **Times** vary depending on the options selected for **Output** and **Frequency**; see the documentation provided with the flash unit for details.

#### **Unified Flash Control**

Unified flash control allows the camera and flash unit to share settings. If a flash unit that supports unified flash control is mounted on the camera, changes to flash settings made with either the camera or flash unit are reflected on both devices, as are changes made using optional Camera Control Pro 2 software.

## Flash Modes

The camera supports the following flash modes:



Flash mode	Description
 Front-curtain sync	This mode is recommended for most situations. In programmed auto and aperture-priority auto modes, shutter speed will automatically be set to values between $1/250$ and $1/60$ s ( $1/8000$ to $1/60$ s with Auto FP High-Speed Sync;  266).
 Red-eye reduction	If flash unit supports red-eye reduction, choose this mode to reduce “red-eye” effect sometimes caused by flash. Not recommended with moving subjects or in other situations in which quick shutter response is required. Do not move camera during shooting.
 Red-eye reduction with slow sync	Combines red-eye reduction with slow sync. Use for portraits taken against a backdrop of night scenery. This mode is only available in programmed auto and aperture-priority auto exposure modes. Use of tripod is recommended to prevent blurring caused by camera shake.
 Slow sync	Flash is combined with shutter speeds as slow as 30 s to capture both subject and background at night or under dim light. This mode is only available in programmed auto and aperture-priority auto exposure modes. Use of tripod is recommended to prevent blurring caused by camera shake.
 Rear-curtain sync	In shutter-priority auto or manual exposure mode, flash fires just before the shutter closes. Use to create effect of a stream of light behind moving objects. In programmed auto and aperture-priority auto, slow rear-curtain sync is used to capture both subject and background. Use of tripod is recommended to prevent blurring caused by camera shake.
 Flash off	Flash does not fire.

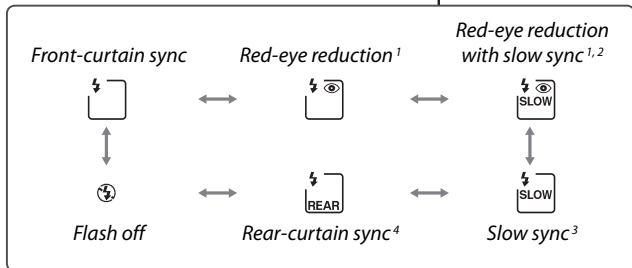
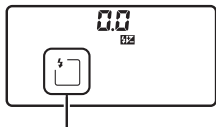
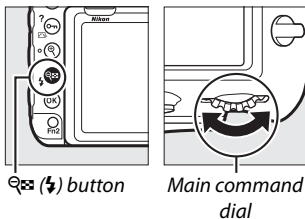

## ■ Choosing a Flash Mode

To choose the flash mode, press the  button and rotate the main command dial until the desired flash mode is selected in the control panel:



- 1  icon flashes if flash unit does not support red-eye reduction.
- 2 Red-eye reduction with slow sync is available only in exposure modes **P** and **A**. In modes **S** and **M**, red-eye reduction with slow sync becomes red-eye reduction.
- 3 Available only in exposure modes **P** and **A**. In modes **S** and **M**, slow sync becomes front-curtain sync.
- 4 In exposure modes **P** and **A**, flash-sync mode will be set to slow rear-curtain sync when the  button is released.



### ■ Studio Flash Systems

Rear-curtain sync cannot be used with studio flash systems, as the correct synchronization cannot be obtained.

## Flash Compensation

Flash compensation is used to alter flash output by from  $-3$  EV to  $+1$  EV in increments of  $\frac{1}{3}$  EV, changing the brightness of the main subject relative to the background. Flash output can be increased to make the main subject appear brighter, or reduced to prevent unwanted highlights or reflections. In general, choose positive values to make the main subject brighter, negative values to make it darker.

To choose a value for flash compensation, press the  $\text{Q} \text{ (⚡)}$  button and rotate the sub-command dial until the desired value is displayed in the control panel.

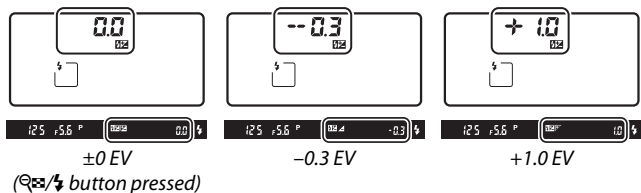
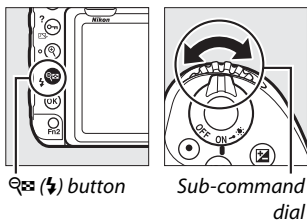





At values other than  $\pm 0.0$ , a  $\text{⚡}$  icon will be displayed in the control panel and viewfinder after you release the  $\text{Q} \text{ (⚡)}$  button. The current value for flash compensation can be confirmed by pressing the  $\text{Q} \text{ (⚡)}$  button.

Normal flash output can be restored by setting flash compensation to  $\pm 0.0$ . Flash compensation is not reset when the camera is turned off.

### See Also

For information on:

- Choosing the size of the increments available for flash compensation, see  > Custom Setting b3 (**Exp./flash comp. step value**,  262).
- Choosing whether flash compensation is applied in addition to exposure compensation when the flash is used, see  > Custom Setting e3 (**Exposure comp. for flash**,  266).
- Automatically varying flash level over a series of shots, see “Bracketing” ( 142).

## FV Lock

This feature is used to lock flash output, allowing photographs to be recomposed without changing the flash level and ensuring that flash output is appropriate to the subject even when the subject is not positioned in the center of the frame. Flash output is adjusted automatically for any changes in ISO sensitivity and aperture. FV lock is available with CLS compatible flash units only (📖 288).

To use FV lock:

- 1 Assign FV lock to a camera control.**  
Assign **FV lock** to a control using Custom Setting f1 (**Custom control assignment**, 📖 268).

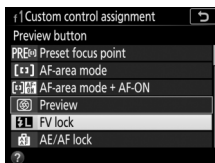

- 2 Attach a CLS-compatible flash unit.**  
Mount a CLS-compatible flash unit (📖 288) on the camera accessory shoe.

- 3 Set the flash unit to the appropriate mode.**  
Turn the flash unit on and set the flash mode to TTL, monitor pre-flash  $\text{⊗A}$ , or monitor pre-flash A. See the documentation provided with the flash unit for details.

- 4 Focus.**  
Position the subject in the center of the frame and press the shutter-release button halfway to focus.



---

## 5 Lock flash level.

After confirming that the flash-ready indicator (⚡) is displayed in the viewfinder, press the control selected in Step 1. The flash will emit a monitor preflash to determine the appropriate flash level. Flash output will be locked at this level and FV lock icon (🔒) will appear in the viewfinder.



---

## 6 Recompose the photograph.



---

## 7 Take the photograph.

Press the shutter-release button the rest of the way down to shoot. If desired, additional pictures can be taken without releasing FV lock.

---

## 8 Release FV lock.

Press the control selected in Step 1 to release FV lock. Confirm that the FV lock icon (🔒) is no longer displayed in the viewfinder.

## Flash Info for Shoe-Mounted Units

The camera can display flash info for flash units that support unified flash control (the SB-5000, SB-500, SB-400, and SB-300) mounted on the camera accessory shoe. To view flash info, press the **info** button in the information display (203). The information displayed varies with the flash control mode.

### ■ TTL

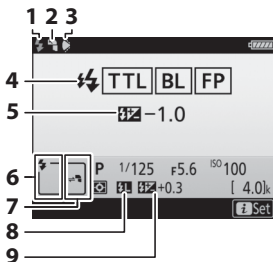

1	Flash-ready indicator.....	187
2	Bounce icon (displayed if flash head is tilted upwards)	
3	Zoom head position warning (displayed if zoom head position is not correct)	
4	Flash control mode .....	190
	FP indicator .....	266
5	Flash compensation (TTL) .....	190, 194
6	Flash mode .....	192
7	Flash control mode .....	201
8	FV lock indicator .....	196
9	Flash compensation .....	194

### ■ Auto External Flash

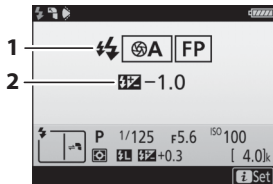

1	Flash control mode .....	190
	FP indicator .....	266
2	Flash compensation (auto aperture) .....	190, 194

## Distance-Priority Manual

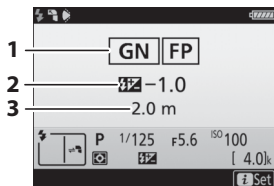

- 1 Flash control mode ..... 190  
FP indicator ..... 266
- 2 Flash compensation (distance-priority manual)..... 190, 194
- 3 Distance ..... 190

## Manual

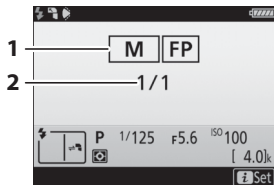

- 1 Flash control mode ..... 190  
FP indicator ..... 266
- 2 Flash level ..... 190

## Repeating Flash

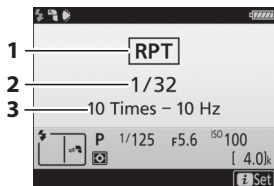

- 1 Flash control mode ..... 190
- 2 Flash level (output) ..... 190
- 3 Number emitted (times) ..... 190  
Frequency ..... 190

## Flash Info and Camera Settings

The flash information display shows selected camera settings, including exposure mode, shutter speed, aperture, and ISO sensitivity.

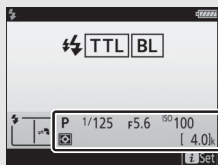

## Changing Flash Settings

Flash settings can be changed by pressing the  button in the flash info display. The options available vary with the flash unit and the settings selected. You can also test-fire the flash.

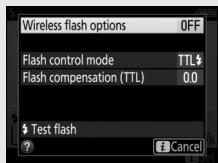



## Flash Control Mode

The information display shows the flash control mode for optional flash units attached to the camera accessory shoe as follows:

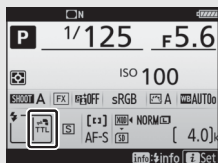

	Flash sync	Auto FP (266)
i-TTL		
Auto aperture (A)		
Non-TTL auto flash (A)		
Distance-priority manual (GN)		
Manual		
Repeating flash		—
Advanced wireless lighting		

## Remote Flash Units

The *Menu Guide* available on Nikon websites (📖 i) offers information on:

- **Controlling remote flash units with optical signals from an optional flash unit mounted on the accessory shoe**

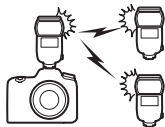

- **Using radio-controlled remote flash units**

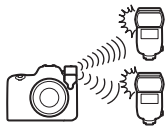

- **Using radio-controlled remote flash units simultaneously with a shoe-mounted flash**

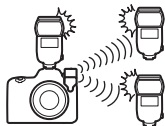

- **Using radio-controlled remote flash units and optically-controlled remote flash units simultaneously**

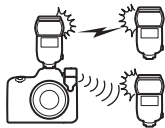

Radio flash control is available only when the camera is connected to a WR-R10 using a WR-A10 adapter. Consult the “Nikon Creative Lighting System (CLS)” for additional information on flash features (📖 288).

# Other Shooting Options

## The **Info** Button

During viewfinder photography, you can press the **Info** button to view an information display in the monitor listing such data as shutter speed, aperture, number of exposures remaining, and AF-area mode.

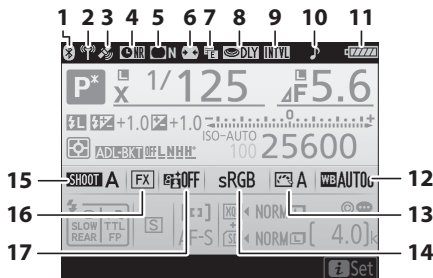

<p><b>1</b> Bluetooth connection indicator ..... 275 Airplane mode ..... 275</p> <p><b>2</b> Wi-Fi connection indicator ..... 275 Eye-Fi connection indicator ..... 276</p> <p><b>3</b> Satellite signal indicator ..... 222</p> <p><b>4</b> Long exposure noise reduction indicator ..... 253</p> <p><b>5</b> Vignette control indicator ..... 253</p> <p><b>6</b> Auto distortion control ..... 253</p> <p><b>7</b> Electronic front-curtain shutter ..... 265</p> <p><b>8</b> Exposure delay mode ..... 264</p>	<p><b>9</b> Interval timer indicator ..... 255 Time-lapse indicator ..... 259 ⌚ (“clock not set”) indicator ..... 206, 271</p> <p><b>10</b> “Beep” indicator ..... 274</p> <p><b>11</b> Camera battery indicator ..... 30 MB-D18 battery type display... 276 MB-D18 battery indicator ..... 299</p> <p><b>12</b> White balance ..... 156</p> <p><b>13</b> Picture Control indicator ..... 175</p> <p><b>14</b> Color space ..... 253</p> <p><b>15</b> Photo shooting menu bank ..... 250</p> <p><b>16</b> Image area indicator ..... 83</p> <p><b>17</b> Active D-Lighting indicator ..... 180</p>
--	--

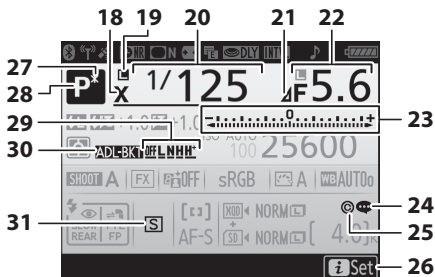

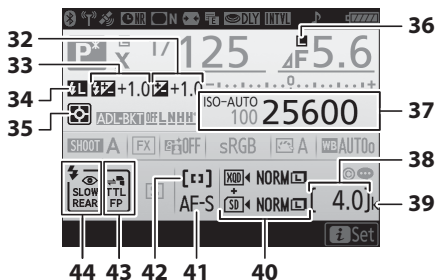

<b>18</b>	Flash sync indicator.....	266	<b>27</b>	Flexible program indicator.....	128
<b>19</b>	Shutter-speed lock icon .....	136	<b>28</b>	Exposure mode .....	126
<b>20</b>	Shutter speed .....	129, 131	<b>29</b>	Position of current frame in bracketing sequence .....	143, 148
<b>21</b>	Aperture stop indicator.....	130		ADL bracketing amount .....	152
<b>22</b>	Aperture (f-number).....	130, 131		HDR exposure differential .....	182
	Aperture (number of stops) .....	130		HDR (series) indicator.....	182
<b>23</b>	Exposure indicator .....	132		Number of exposures (multiple exposure) .....	254
	Exposure compensation display .....	139		Multiple exposure (series) indicator .....	254
	Bracketing progress indicator: Exposure and flash bracketing.....	143	<b>30</b>	Exposure and flash bracketing indicator .....	143
	WB bracketing.....	148		WB bracketing indicator .....	148
<b>24</b>	Image comment indicator .....	273		ADL bracketing indicator .....	152
<b>25</b>	Copyright information indicator .....	273		HDR indicator .....	182
<b>26</b>	<b>i</b> icon.....	208		Multiple exposure indicator ....	254
			<b>31</b>	Release mode.....	113



<b>32</b>	Exposure compensation indicator..... 139	<b>39</b>	Number of exposures remaining ..... 31, 362
	Exposure compensation value ... 139		Manual lens number..... 218
<b>33</b>	Flash compensation indicator ..... 194	<b>40</b>	Image quality ..... 88
	Flash compensation value..... 194		Secondary slot function..... 93
<b>34</b>	FV lock indicator..... 196		Image size..... 91
<b>35</b>	Metering ..... 124		XQD card icon ..... 16, 93
<b>36</b>	Aperture lock icon ..... 136		SD card icon ..... 16, 93
<b>37</b>	ISO sensitivity ..... 119	<b>41</b>	Autofocus mode ..... 98
	ISO sensitivity indicator..... 119	<b>42</b>	AF-area mode ..... 100, 103
	Auto ISO sensitivity indicator ... 121	<b>43</b>	Flash control mode ..... 190
<b>38</b>	"k" (appears when memory remains for over 1000 exposures) ..... 31	<b>44</b>	Flash mode..... 192

**Note:** Display shown with all indicators lit for illustrative purposes.



### **Turning the Monitor Off**

To clear shooting or flash information from the monitor, press the  button or press the shutter-release button halfway. The monitor will turn off automatically if no operations are performed for about 10 seconds. For information on choosing how long the monitor remains on before turning off automatically, see  > Custom Setting c4 (**Monitor off delay**,  264).

### **The ☺ Indicator**



The camera clock is powered by an independent, rechargeable power source, which is charged as necessary when the main battery is installed or the camera is powered by an optional power connector and AC adapter. Two days of charging will power the clock for about three months. If the ☺ icon flashes in the information display, the clock has been reset and the date and time recorded with any new photographs will not be correct. Set the clock to the correct time and date using the **Time zone and date** > **Date and time** option in the setup menu ( 271).

### **See Also**

For information on changing the color of the lettering in the information display, see  > **Information display** ( 272).



## Using the Command Dials

The settings in the information display can be adjusted by keeping one of the following buttons pressed while rotating a command dial:

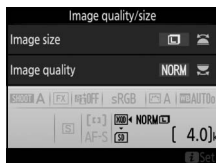
- **QUAL** (📖 88, 91)
- **WB** (📖 156; to fine-tune white balance, keep the button pressed and use the multi-selector)
- **MODE** (📖 126)
-  (📖 124)
-  (📖 139)
- **ISO** (📖 119)
-  (📖 192, 194)
- **BKT** (📖 142)
- AF-mode (📖 98, 100)
- Any of the buttons that can be assigned a function using Custom Setting f1 (**Custom control assignment**, 📖 268) or f10 (**Assign MB-D18 buttons**, 📖 270), provided the button can be used in combination with the command dials



### White Balance

Press the **WB** button to adjust white balance settings in the information display. Rotate the main command dial to choose the white balance mode and rotate the sub-command dial to choose a sub-option for **AUTO** (auto) or  (fluorescent) mode, the color temperature (mode , “choose color temperature”), or white balance preset (preset manual mode).

In modes other than  (“choose color temperature”) and preset manual, you can use the multi-selector to fine-tune white balance on the amber (A)–blue (B) and green (G)–magenta (M) axes.

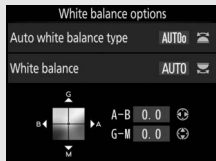

## The *i* button

To access the options below, press the *i* button during viewfinder photography. Use the touch screen or navigate the menu using the multi selector and  $\text{OK}$  button, pressing  $\leftarrow$  or  $\rightarrow$  to highlight items and  $\text{OK}$  to view options. To return to shooting mode, press the shutter-release button halfway.

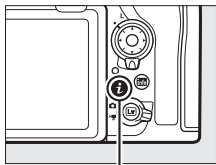

*i* button

Option	
<b>Photo shooting menu bank</b>	250
<b>Custom settings bank</b>	260
<b>Custom control assignment</b>	268
<b>Active D-Lighting</b>	180
<b>Choose image area</b>	86
<b>Long exposure NR</b>	253
<b>High ISO NR</b>	253

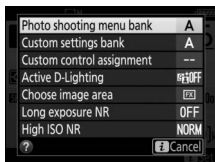



## Two-Button Reset: Restoring Default Settings

The camera settings listed below can be restored to default values by holding the **QUAL** and **☒** buttons down together for more than two seconds (these buttons are marked by a green dot). The control panel turns off briefly while settings are reset.

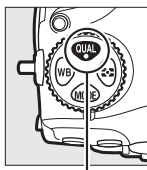

**QUAL** button

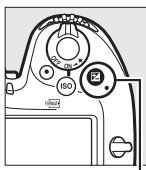

**☒** button

## ■ Settings Accessible from the Photo Shooting Menu<sup>1</sup>

Option	Default
Extended photo menu banks	Off
Image quality	JPEG normal
Image size	
JPEG/TIFF	Large
NEF (RAW)	Large
ISO sensitivity settings	
ISO sensitivity	100
Auto ISO sensitivity control	Off
White balance	Auto > Keep white (reduce warm colors)
Fine-tuning	A-B: 0, G-M: 0
Picture Control settings <sup>2</sup>	Unmodified
Flicker reduction	
Flicker reduction setting	Disable
Flicker reduction indicator	On
Multiple exposure	Off <sup>3</sup>
HDR (high dynamic range)	Off <sup>4</sup>
Silent live view photography	Off

- 1 With the exception of multiple exposure, only settings in the bank currently selected using the **Photo shooting menu bank** option will be reset (□ 250). Settings in the remaining banks are unaffected.
- 2 Current Picture Control only.
- 3 If multiple exposure is currently in progress, shooting will end and multiple exposure will be created from exposures recorded to that point. Overlay mode, number of shots, and **Keep all exposures** are not reset.
- 4 Exposure differential and smoothing are not reset.

## ■ Settings Accessible from the Movie Shooting Menu

Option	Default
ISO sensitivity settings	
ISO sensitivity (mode M)	100
White balance	Same as photo settings
Active D-Lighting	Off
Electronic VR	Off

## ■ ■ Other Settings

Option	Default
Focus point <sup>1</sup>	Center
Preset focus point	Center
Exposure mode	Programmed auto
Flexible program	Off
Exposure compensation	Off
AE lock hold	Off
Exposure preview	Off
Shutter speed lock	Off
Aperture lock	Off
Autofocus mode	AF-S
AF-area mode	
Viewfinder	Single-point AF
Live view	Normal-area AF
Photo live view display WB	None
Multi-selector power aperture	Disable
Multi selector exposure comp.	Disable
Highlight display	Off
Headphone volume	15
Metering	Matrix metering
Bracketing	Off <sup>2</sup>
Flash mode	Front-curtain sync
Flash compensation	Off
FV lock	Off
Exposure delay mode	Off <sup>3</sup>

- 1 Focus point not displayed if auto-area AF is selected for AF-area mode.
- 2 Number of shots is reset to zero. Bracketing increment is reset to 1EV (exposure/flash bracketing) or 1 (white balance bracketing). **AF-A Auto** is selected for the second shot of two-shot ADL bracketing programs.
- 3 Only settings in the bank currently selected using the **Custom settings bank** option will be reset (□ 260). Settings in the remaining banks are unaffected.

## Focus Shift Photography

During focus shift, the camera automatically varies focus over a series of photographs. This feature can be used to take photos that will later be combined using focus stacking. Before using focus shift, rotate the focus mode selector to **AF** and choose a release mode other than .

### ☑ Before Shooting

Use an AF-S or AF-P lens. After mounting the appropriate lens, choose an exposure mode of **A** or **M** so that aperture does not change during shooting (recommended), then take a test shot at current settings and view the results in the monitor. Once settings have been adjusted to your satisfaction, close the viewfinder eyepiece shutter to prevent light entering via the viewfinder interfering with photographs and exposure.

We recommend using a tripod and disabling lens vibration reduction (VR). Mount the camera on a tripod before shooting begins. To ensure that shooting is not interrupted, be sure the camera battery is fully charged. If in doubt, charge the battery before use or use an AC adapter and power connector (available separately).

## Focus Shift Photography

- Select Focus shift shooting.**  
Highlight **Focus shift shooting** in the photo shooting menu and press  to display focus shift options.

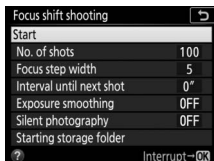
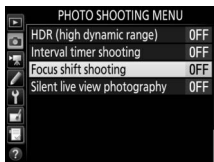

## 2 Adjust focus shift settings.

Adjust focus shift settings as described below.

- To choose the number of shots:

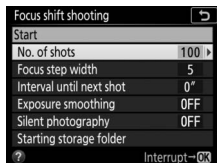

Highlight **No. of shots** and press .

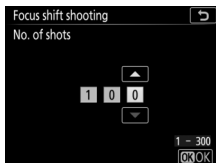



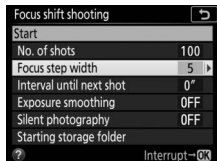

Choose the number of shots (max. 300) and press .

- To choose the amount the focus distance changes with each shot:

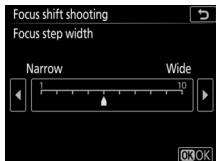

Highlight **Focus step width** and press .





Press  to reduce the focus step width,  to increase. Press  to proceed.

### Close-ups

Because depth of focus is reduced at short focus distances, we recommend choosing smaller focus steps and increasing the number of shots when photographing subjects close to the camera.

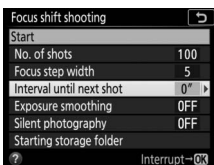
- To choose the interval between shots:



Highlight **Interval until next shot** and press .

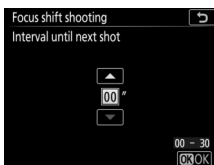

Choose the number of seconds between shots and press .

Select **00** to take photos at approximately 5 fps (release modes **S**, **CL**, **Ch**, and **MUP**) or 3 fps (release modes **Q** and **QC**). To ensure the correct exposure when using a flash, choose an interval long enough for the flash to charge.

- To enable or disable exposure smoothing:

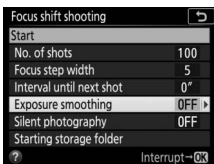

Highlight **Exposure smoothing** and press .

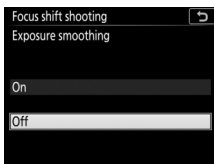

Highlight an option and press .

Selecting **On** allows the camera to adjust exposure to match previous shot in modes other than **M** (note that exposure smoothing only takes effect in mode **M** if auto ISO sensitivity control is on). Large changes in subject brightness during shooting may result in apparent variations in exposure, in which case it may be necessary to shorten the interval between shots.

- **To enable or disable silent photography:**

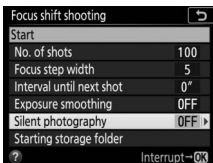

Highlight **Silent photography** and press .

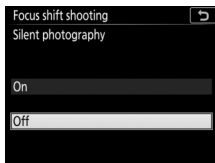

Highlight an option and press .

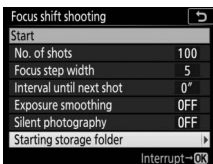

Select **On** to silence the shutter during shooting.

- **Choose start folder options:**

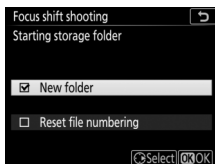

Highlight **Starting storage folder** and press .



Highlight options and press  to select or deselect. Press  to proceed.

Select **New folder** to create a new folder for each new sequence, **Reset file numbering** to reset file numbering to 0001 whenever a new folder is created.

### 3 Start shooting.

Highlight **Start** and press  $\odot$ . Shooting starts after about 3 s. The camera takes photographs at the selected interval, starting at the focus distance selected at the start of shooting and progressing out toward infinity by the selected focus step distance with each shot. Shooting ends when the selected number of shots has been taken or focus reaches infinity. To end shooting before all shots have been taken, select **Off** for **Focus shift shooting** in the photo shooting menu or press the shutter-release button halfway or press the  $\odot$  button between shots.

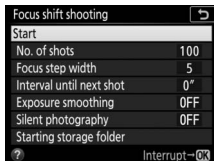

#### Aperture

To prevent the loss of definition that can occur at smaller apertures, choose an aperture with an f-number lower than  $f/11$ – $f/8$ .

#### During Shooting

During focus shift photography, the **INTVL** icon will flash in the control panel.

Immediately before the next shot, the shutter speed display will show the number of shots remaining. Regardless of the option selected for Custom Setting c2 (**Standby timer**,  263), the standby timer will not expire during shooting.

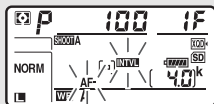

Settings can be adjusted, the menus used, and pictures played back while focus shift photography is in progress. The monitor will turn off automatically about four seconds before each shot. Note that changing camera settings while focus shift photography is in progress may cause shooting to end.



### ☑ Focus Shift Photography

If you are using a flash, choose an interval longer than the time needed for the flash to charge. If the interval is too short, the flash may fire at less than the power needed for full exposure. Focus shift cannot be combined with some camera features, including live view (☐ 37), movie recording (☐ 59), time-lapse movies, bracketing, the self-timer (☐ 116), long time-exposures (bulb or time photography; ☐ 133), HDR (high dynamic range), multiple exposure, and interval timer photography. Note that because the shutter speed and time needed to record images may vary from one shot to the next, the time between the end of one interval and the beginning of the next may vary. If shooting cannot proceed at current settings (for example, if shutter speed is set to  $\frac{1}{2}$  or -), a warning will be displayed in the monitor.

### 🔇 Silent Photography

Selecting **On** for **Silent photography** disables some camera features, including:

- ISO sensitivities of **Hi 0.3** through **Hi 2** (☐ 119)
- Flash photography (☐ 187)
- Exposure delay mode (☐ 264)
- Flicker reduction (☐ 258)

## Non-CPU Lenses

Non-CPU lenses can be used in exposure modes **A** and **M**, with aperture set using the lens aperture ring. By specifying lens data (lens focal length and maximum aperture), the user can gain access to the following CPU lens functions.

*If the focal length of the lens is known:*

- Power zoom can be used with optional flash units
- Lens focal length is listed (with an asterisk) in the playback photo info display

*If the maximum aperture of the lens is known:*

- The aperture value is displayed in the control panel and viewfinder
- Flash level is adjusted for changes in aperture if the flash unit supports A (auto aperture) mode
- Aperture is listed (with an asterisk) in the playback photo info display

*Specifying both the focal length and maximum aperture of the lens:*

- Enables color matrix metering (note that it may be necessary to use center-weighted or spot metering to achieve accurate results with some lenses, including Reflex-NIKKOR lenses)
- Improves the precision of center-weighted and spot metering and i-TTL balanced fill-flash for digital SLR



To enter or edit data for a non-CPU lens:

## 1 Select Non-CPU lens data.

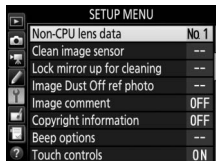
Highlight **Non-CPU lens data** in the setup menu and press .



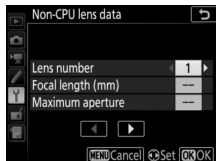

## 2 Select a lens number.

Highlight **Lens number** and press  or  to choose a lens number.



## 3 Enter the focal length and aperture.

Highlight **Focal length (mm)** or **Maximum aperture** and press  or  to edit the highlighted item.

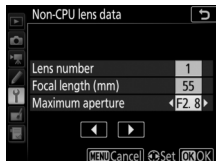

## 4 Save settings and exit.

Press . The specified focal length and aperture will be stored under the chosen lens number.

To recall lens data when using a non-CPU lens:

---

**1 Assign non-CPU lens number selection to a camera control.**

Assign **Choose non-CPU lens number** to a control using Custom Setting f1 (**Custom control assignment**,  268).

---

**2 Use the selected control to choose a lens number.**

Press the selected control and rotate the main or sub-command dial until the desired lens number is displayed in the control panel.

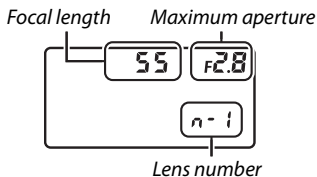
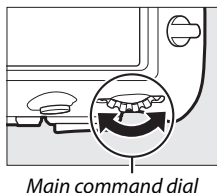

 **Focal Length Not Listed**

If the correct focal length is not listed, choose the closest value greater than the actual focal length of the lens.

 **Teleconverters and Zoom Lenses**

The maximum aperture for teleconverters is the combined maximum aperture of the teleconverter and the lens. Note that lens data are not adjusted when non-CPU lenses are zoomed in or out. The data for different focal lengths can be entered as separate lens numbers, or the data for the lens can be edited to reflect the new values for lens focal length and maximum aperture each time zoom is adjusted.

## Location Data

The GP-1/GP-1A GPS unit (available separately) can be connected to the camera's ten-pin remote terminal (□ 296) using the cable supplied with the GP-1/GP-1A, allowing information on the camera's current position to be recorded when photographs are taken and viewed in the playback photo info display (□ 229). Turn the camera off before connecting the GP-1/ GP-1A; for more information, see the GP-1/GP-1A manual.

### ■ ■ Setup Menu Options

The **Location data** item in the setup menu contains the options listed below.



- **Position:** The current latitude, longitude, altitude, and Coordinated Universal Time (UTC).
- **External GPS device options > Standby timer:** Choose whether or not the standby timer is enabled when a GPS unit is attached.

Option	Description
Enable	Standby timer enabled. The timer expires automatically if no operations are performed for the period specified in Custom Setting c2 ( <b>Standby timer</b> , □ 263), reducing the drain on the battery. If a GP-1 or GP-1A unit is connected, the unit will remain active for a set period after the timer expires; to allow the camera time to acquire location data, the delay is extended by up to one minute after exposure meters are activated or the camera is turned on.
Disable	Standby timer disabled, ensuring uninterrupted recording of location data.

- **External GPS device options > Set clock from satellite:** Select **Yes** to synchronize the camera clock with the time reported by the GPS device.

## The Icon

Connection status is shown by the  icon:

-  (**static**): Location data acquired.
-  (**flashing**): The GP-1/GP-1A is searching for a signal. Pictures taken while the icon is flashing do not include location data.
- **No icon**: No new location data have been received from the GP-1/GP-1A for at least two seconds. Pictures taken when the  icon is not displayed do not include location data.

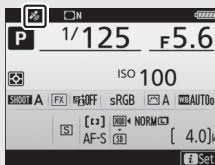

## Smart Devices

To download location data from a smart device and embed it in subsequent photographs, establish a wireless connection, enable the location data feature in the SnapBridge app, and select **Yes** for **Location data** > **Download from smart device** in the camera setup menu (📖 274).

## Coordinated Universal Time (UTC)



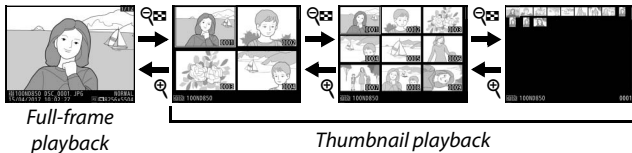

UTC data is provided by the GPS device and is independent of the camera clock.

# More About Playback

## Viewing Images





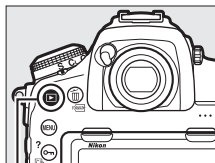

### Full-Frame Playback

To play photographs back, press the  button. The most recent photograph will be displayed in the monitor. Additional pictures can be displayed by flicking left or right or pressing  or ; to view additional information on the current photograph, press  or  (book 229).





 button

### Thumbnail Playback

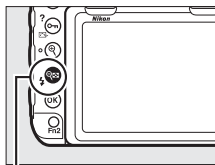
To view multiple images, press the  () button when a picture is displayed full frame. The number of images displayed increases from 4 to 9 to 72 each time the  () button is pressed, and decreases with each press of the  button. Slide a finger over the touch screen to scroll up or down or use the multi selector to highlight images.



 () button

## Playback Controls

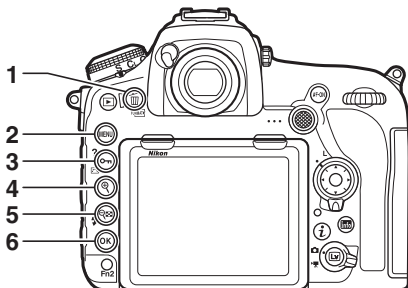

- 1 (FORMAT): Delete the current picture ..... 245
- 2 MENU: View the menus ..... 248
- 3 (L-3/?): Protect the current picture ..... 240

- 4 : Zoom in ..... 238
- 5 (⚡): View multiple images ... 223
- 6 : Use in combination with the multi selector as described below

### ■ Using the Button with the Multi Selector

+	Display slot/folder selection dialog. To choose card and folder from which pictures are played back, highlight slot and press  to display list of folders, then highlight folder and press .
+	Create retouched copy of current photograph ( 278).
+	Upload photographs over a wireless or Ethernet network when a WT-7 is attached to the camera ( 296).

### ■ Two Memory Cards

If two memory cards are inserted, you can select a memory card for playback by pressing the button when 72 thumbnails are displayed.



### **Rotate Tall**

To display “tall” (portrait-orientation) photographs in tall orientation, select **On** for the **Rotate tall** option in the playback menu (📖 249).





### **Image Review**

When **On** is selected for **Image review** in the playback menu (📖 249), photographs are automatically displayed in the monitor after shooting (because the camera is already in the correct orientation, images are not rotated automatically during image review). In continuous release mode, display begins when shooting ends, with the first photograph in the current series displayed.



### **See Also**

For information on:

- Choosing how long the monitor will remain on when no operations are performed, see  > Custom Setting c4 (**Monitor off delay**, 📖 264).
- Choosing the role played by the center of the multi selector, see  > Custom Setting f2 (**Multi selector center button**, 📖 268).
- Using the command dials for image or menu navigation, see  > Custom Setting f4 (**Customize command dials**) > **Menus and playback** (📖 269).

## Using the Touch Screen

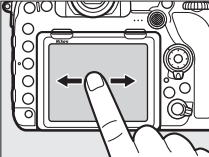
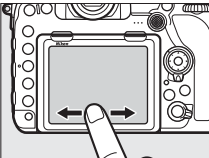
During playback, the touch-sensitive monitor can be used to:

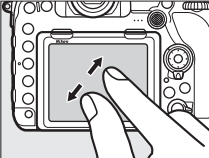
<b>View other images</b>	Flick left or right to view other images.	
<b>Scroll rapidly to other images</b>	In full frame view, you can touch the bottom of the display to display a frame advance bar, then slide your finger left or right to scroll rapidly to other images.	  <i>Frame advance bar</i>
<b>Zoom in (photos only)</b>	Use stretch and pinch gestures to zoom in and out and slide to scroll (📖 238). You can also give the display two quick taps to zoom in from full-frame playback or cancel zoom.	

**View thumbnails**

To “zoom out” to a thumbnail view (📖 223), use a pinch gesture in full-frame playback. Use pinch and stretch to choose the number of images displayed from 4, 9, and 72 frames.

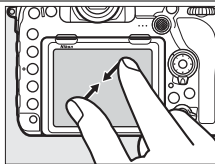
**View movies**

Tap the on-screen guide to start movie playback (movies are indicated by a 🎬 icon). Tap the display to pause or resume, or tap ↶ to exit to full-frame playback (note that some of the icons in the movie playback display do not respond to touch-screen operations).



*Guide*



## The *i* Button

Pressing the *i* button during full-frame or thumbnail playback displays the options listed below. Select options using the touch screen or the multi selector and  $\text{OK}$  button.

- **Rating:** Rate the current picture (📖 241).
- **Select to send to smart device/deselect (photographs only):** Select photos for upload to a smart device.
- **Retouch (photographs only):** Use the options in the retouch menu (📖 278) to create a retouched copy of the current photograph.
- **Volume control (movies only):** Adjust playback volume for movies.
- **Trim movie (movies only):** Trim unwanted footage from movies (📖 78). Movies can also be edited by pressing the *i* button when movie playback is paused.
- **Choose slot and folder:** Choose a folder for playback. Highlight a slot and press  $\text{DISC}$  to list the folders on the selected card, then highlight a folder and press  $\text{OK}$  to view the pictures in the highlighted folder.

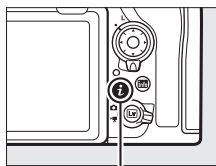

*i* button

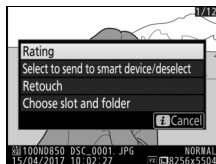

To exit the *i*-button menu and return to playback, press the *i* button again.

## Photo Information

Photo information is superimposed on images displayed in full-frame playback. Press or to cycle through photo information as shown below. Note that “image only”, shooting data, RGB histograms, highlights, and overview data are only displayed if corresponding option is selected for **Playback display options** (248). Location data are only displayed if embedded in the picture (221).

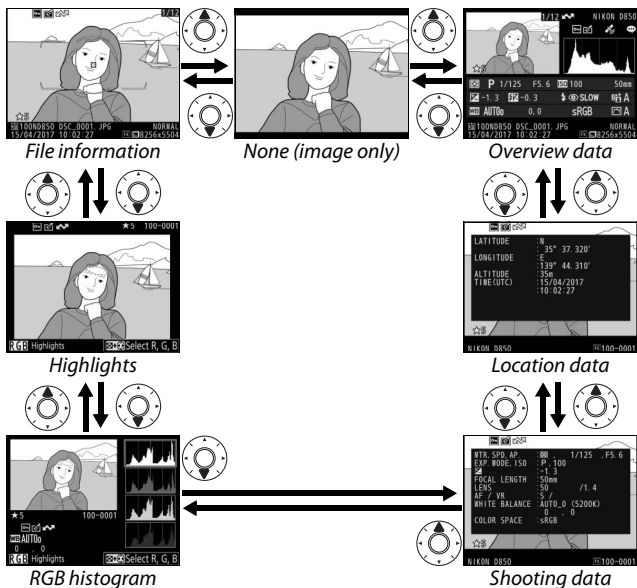

## File Information

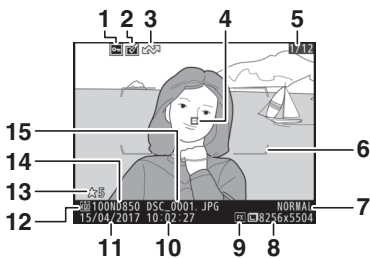

1	Protect status.....	240	8	Image size .....	91
2	Retouch indicator .....	278	9	Image area .....	83
3	Upload marking .....	243	10	Time of recording .....	21, 271
4	Focus point* .....	94, 105	11	Date of recording .....	21, 271
5	Frame number/total number of frames		12	Current card slot .....	35, 93
6	AF area brackets* .....	9	13	Rating .....	241
7	Image quality .....	88	14	Folder name.....	250
			15	File name .....	250

\* Displayed only if **Focus point** is selected for **Playback display options** (☐ 248) and selected photograph was taken using viewfinder.

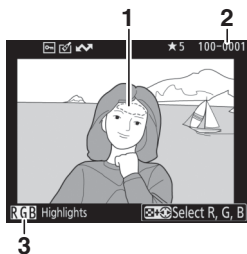

## Highlights



1 Image highlights\*

2 Folder number–frame number

3 Current channel\*

\* Flashing areas indicate highlights (areas that may be overexposed) for current channel. Hold the  button and press  or  to cycle through channels as follows:

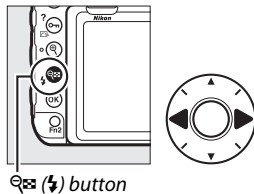

## RGB Histogram

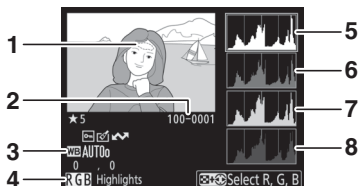

- |   |  |
|---|--|
| <b>1</b> Image highlights*  | <b>5</b> Histogram (RGB channel). In all histograms, horizontal axis gives pixel brightness, vertical axis number of pixels. |
| <b>2</b> Folder number–frame number   | <b>6</b> Histogram (red channel)   |
| <b>3</b> White balance ..... 156<br>Color temperature ..... 163<br>White balance fine-tuning ..... 161<br>Preset manual ..... 165 | <b>7</b> Histogram (green channel)   |
| <b>4</b> Current channel*   | <b>8</b> Histogram (blue channel)  |

\* Flashing areas indicate highlights (areas that may be overexposed) for current channel. Hold the button and press or to cycle through channels as follows:

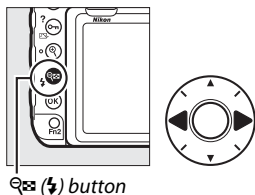



## Playback Zoom

To zoom in on the photograph when the histogram is displayed, press . Use the and buttons to zoom in and out and scroll the image with the multi selector. The histogram will be updated to show only the data for the portion of the image visible in the monitor.



## Histograms

Camera histograms are intended as a guide only and may differ from those displayed in imaging applications. Some sample histograms are shown below:

If the image contains objects with a wide range of brightnesses, the distribution of tones will be relatively even.



If the image is dark, tone distribution will be shifted to the left.



If the image is bright, tone distribution will be shifted to the right.



Increasing exposure compensation shifts the distribution of tones to the right, while decreasing exposure compensation shifts the distribution to the left. Histograms can provide a rough idea of overall exposure when bright ambient lighting makes it difficult to see photographs in the monitor.

## ■ Shooting Data

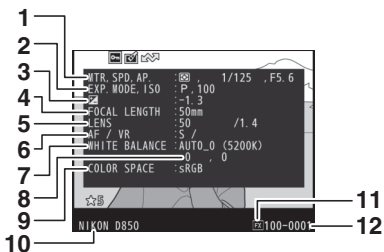

<b>1</b> Metering ..... 124	<b>6</b> Focus mode ..... 41, 94
Shutter speed ..... 129, 131	Lens VR (vibration reduction) <sup>3</sup>
Aperture..... 130, 131	<b>7</b> White balance <sup>4</sup> ..... 156
<b>2</b> Exposure mode ..... 126	<b>8</b> White balance fine-tuning ..... 161
ISO sensitivity <sup>1</sup> ..... 119	<b>9</b> Color space ..... 253
<b>3</b> Exposure compensation ..... 139	<b>10</b> Camera name
Optimal exposure tuning <sup>2</sup> ..... 263	<b>11</b> Image area ..... 83
<b>4</b> Focal length ..... 218	<b>12</b> Folder number–frame number
<b>5</b> Lens data ..... 218	

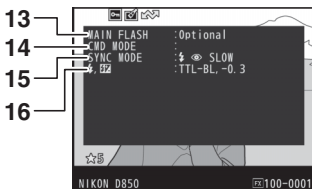

<b>13</b> Flash type <sup>5</sup>	<b>16</b> Flash control mode <sup>5</sup> ..... 190
<b>14</b> Remote flash control <sup>5</sup> ..... 202	Flash compensation <sup>5</sup> ..... 194
<b>15</b> Flash mode <sup>5</sup> ..... 192	



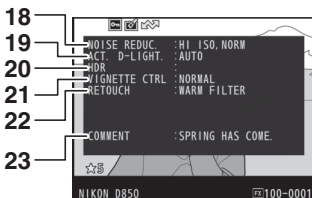

**17** Picture Control<sup>6</sup>..... 175

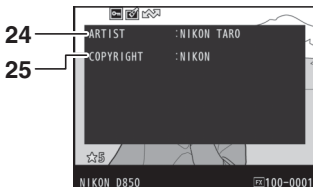

<b>18</b> High ISO noise reduction..... 253	<b>20</b> HDR exposure differential ..... 182
Long exposure noise reduction ..... 253	HDR smoothing..... 182
<b>19</b> Active D-Lighting..... 180	<b>21</b> Vignette control ..... 253
	<b>22</b> Retouch history..... 278
	<b>23</b> Image comment ..... 273



**24** Name of photographer<sup>7</sup> ..... 273    **25** Copyright holder<sup>7</sup> ..... 273

- 1 Displayed in red if photo was taken with auto ISO sensitivity control on.
- 2 Displayed if Custom Setting b7 (**Fine-tune optimal exposure**,  263) has been set to a value other than zero for any metering method.
- 3 Displayed only if VR lens is attached.
- 4 Also includes color temperature of photos taken using auto white balance.
- 5 Displayed only if optional flash unit ( 187) is used.
- 6 The items displayed vary with the Picture Control selected when the picture was taken.
- 7 Copyright information is only displayed if recorded with the photograph using the **Copyright information** option in the setup menu.

## ■■ Location Data

The latitude, longitude, and other location data are supplied by and vary with the GPS or smart device ( 221). In the case of movies, the data give the location at the start of recording.

## Overview Data

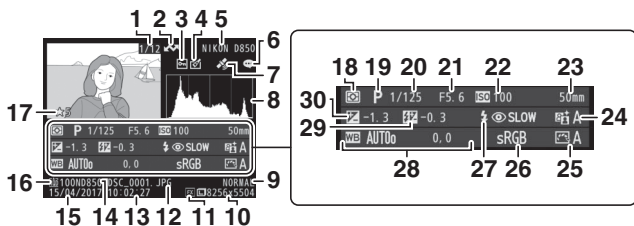

<b>1</b> Frame number/total number of frames	<b>17</b> Rating .....	241
<b>2</b> Upload marking .....	<b>18</b> Metering .....	124
<b>3</b> Protect status .....	<b>19</b> Exposure mode .....	126
<b>4</b> Retouch indicator .....	<b>20</b> Shutter speed .....	129, 131
<b>5</b> Camera name	<b>21</b> Aperture.....	130, 131
<b>6</b> Image comment indicator.....	<b>22</b> ISO sensitivity <sup>1</sup> .....	119
<b>7</b> Location data indicator .....	<b>23</b> Focal length .....	218
<b>8</b> Histogram showing the distribution of tones in the image (□ 233).	<b>24</b> Active D-Lighting .....	180
<b>9</b> Image quality.....	<b>25</b> Picture Control .....	175
<b>10</b> Image size.....	<b>26</b> Color space.....	253
<b>11</b> Image area.....	<b>27</b> Flash mode <sup>2</sup> .....	192
<b>12</b> File name .....	<b>28</b> White balance.....	156
<b>13</b> Time of recording .....	Color temperature .....	163
<b>14</b> Folder name .....	White balance fine-tuning .....	161
<b>15</b> Date of recording .....	Preset manual .....	165
<b>16</b> Current card slot.....	<b>29</b> Flash compensation <sup>2</sup> .....	194
	Commander mode <sup>2</sup> .....	
	<b>30</b> Exposure compensation .....	139







1 Displayed in red if photo was taken with auto ISO sensitivity control on.

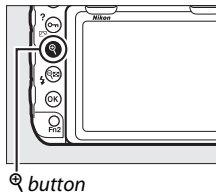

2 Displayed only if photo was taken with optional flash unit (□ 187).

## Taking a Closer Look: Playback Zoom

To zoom in on an image displayed in full-frame playback, press the  button or the center of the multi selector or give the display two quick taps. The following operations can be performed while zoom is in effect:



To	Description
Zoom in or out/ view other areas of image	<p>Press  or use stretch gestures to zoom in to maximum of approximately 32× (large images in FX/36 × 24 format), 24× (medium images) or 16× (small images). Press   or use pinch gestures to zoom out. While photo is zoomed in, use multi selector or slide finger over screen to view areas of image not visible in monitor. Keep multi selector pressed to scroll rapidly to other areas of frame. Navigation window is displayed when zoom ratio is altered; area currently visible in monitor is indicated by yellow border. Bar under navigation window shows zoom ratio, turning green at 1 : 1.</p> 
Crop image	<p>To create crop image to area currently visible in monitor, press , highlight <b>Quick crop</b> and press . Note that <b>Quick crop</b> is not available when RGB histogram is displayed ( 233).</p>

To	Description	
Select faces	Faces detected during zoom are indicated by white borders in navigation window. Rotate sub-command dial or tap on-screen guide to view other faces.	<p data-bbox="655 106 837 132"><i>On-screen guide</i></p> 
View other images	Rotate main command dial or tap ◀ or ▶ icons at bottom of display to view same location in other photos at current zoom ratio. Playback zoom is cancelled when a movie is displayed.	
Change protect status	Press  (🔒/? ) to protect or remove protection from images (📖 240).	
Return to shooting mode	Press the shutter-release button halfway or press the  button to exit to shooting mode.	
Display menus	Press <b>MENU</b> to view the menus (📖 248).	

## Protecting Photographs from Deletion

In full-frame, zoom, and thumbnail playback, the **Q** (L<sup>2</sup>/?) button can be used to protect photographs from accidental deletion. Protected files cannot be deleted using the **W** (FORMAT) button or the **Delete** option in the playback menu. Note that protected images *will* be deleted when the memory card is formatted (□ 271).

To protect a photograph:

### 1 Select an image.

Display the image in full-frame playback or playback zoom or highlight it in the thumbnail list.

### 2 Press the **Q** (L<sup>2</sup>/?) button.

The photograph will be marked with a **Q** icon. To remove protection from the photograph so that it can be deleted, display the photograph or highlight it in the thumbnail list and then press the **Q** (L<sup>2</sup>/?) button.

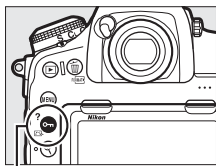

**Q** (L<sup>2</sup>/?) button



### **Q** Removing Protection from All Images

To remove protection from all images in the folder or folders currently selected in the **Playback folder** menu, press the **Q** (L<sup>2</sup>/?) and **W** (FORMAT) buttons together for about two seconds during playback.



## Rating Pictures

Rate pictures or mark them as candidates for later deletion. Ratings can also be viewed in ViewNX-i and Capture NX-D. Rating is not available with protected images.

### 1 Select an image.

Display the image or highlight it in the thumbnail list in thumbnail playback.

### 2 Display playback options.

Press the **i** button to display playback options.

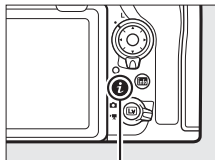

*i* button

### 3 Select Rating.

Highlight **Rating** and press **▶**.

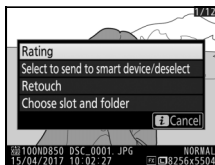



### 4 Choose a rating.

Press **◀** or **▶** to choose a rating of from zero to five stars, or select **✖** to mark the picture as a candidate for later deletion. Press **OK** to complete the operation.



### Rating Pictures with the Fn2 Button

If **Rating** is selected for Custom Setting f1 (**Custom control assignment**) > **Fn2 button**, pictures can be rated by keeping the **Fn2** button pressed and pressing  or  (□ 268).

## Selecting Photos for Upload

Follow the steps below to select photos for upload to the smart device. Movies cannot be selected for upload; photos are uploaded at a size of 2 megapixels.

### Selecting Individual Photos

#### 1 Select a photo.

Display the photo or highlight it in the thumbnail list in thumbnail playback.

#### 2 Display playback options.

Press the **i** button to display playback options.

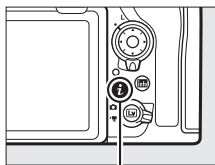

*i* button

#### 3 Choose **Select to send to smart device/deselect**.

Highlight **Select to send to smart device/deselect** and press **OK**.

Pictures selected for upload are indicated by a  icon; to deselect, display or highlight the image and repeat Steps 2 and 3.

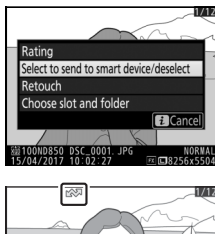

## Selecting Multiple Photos

Follow the steps below to change the upload status of multiple photos.

### 1 Choose **Select image(s)**.

In the playback menu, select **Select to send to smart device**, then highlight **Select image(s)** and press **OK**.



### 2 Select photos.

Use the multi selector to highlight photos and press the center of the multi selector to select or deselect (to view the highlighted picture full screen, press and hold the **Q** button). Selected photos are marked by a **↕** icon.

### 3 Press **OK**.

Press **OK** to complete the operation.

#### **✍** Deselecting All Photos

To deselect all photos, select **Select to send to smart device** in the playback menu, highlight **Deselect all**, and press **OK**. A confirmation dialog will be displayed; highlight **Yes** and press **OK** to remove upload marking from all photos on the memory card.

## Deleting Photographs

To delete the current photograph, press the  button. To delete multiple selected photographs, use the **Delete** option in the playback menu. Once deleted, photographs cannot be recovered. Note that pictures that are protected or hidden cannot be deleted.

### During Playback

Press the  button to delete the current photograph.

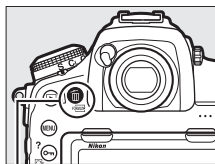

#### 1 Press the button.

A confirmation dialog will be displayed.



 button

#### 2 Press the button again.

To delete the photograph, press the  button. To exit without deleting the photograph, press the  button.

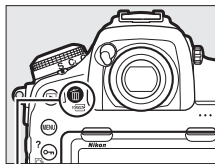

 button

#### See Also

For information on choosing the image displayed after an image is deleted, see  > **After delete** (📖 249).

## The Playback Menu

The **Delete** option in the playback menu contains the following options. Note that depending on the number of images, some time may be required for deletion.

Option	Description
 <b>Selected</b>	Delete selected pictures.
<b>ALL All</b>	Delete all pictures in the folder currently selected for playback (📁 248). If two cards are inserted, you can select the card from which pictures will be deleted.

### ■ Selected: Deleting Selected Photographs

#### 1 Choose **Delete** > **Selected**.

Select **Delete** in the playback menu. Highlight **Selected** and press .

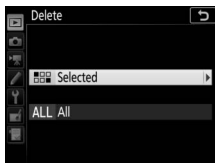

#### 2 Highlight a picture.

Use the multi selector to highlight a picture (to view the highlighted picture full screen, press and hold the  button).



---

### 3 Select the highlighted picture.

Press the center of the multi selector to select the highlighted picture.

Selected pictures are marked by a  icon. Repeat

steps 2 and 3 to select additional pictures; to deselect a picture, highlight it and press the center of the multi selector.



---

### 4 Press **OK** to complete the operation.

A confirmation dialog will be displayed; highlight **Yes** and press **OK**.

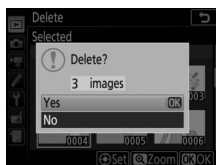

# Menu List

This section lists the options available in the camera menus. For more information, see the *Menu Guide* available from Nikon websites (☞ i).

## ▶ The Playback Menu: *Managing Images*

### Delete

Selected Delete multiple images (☞ 246).

All

### Playback folder (defaults to **All**)

(Folder name) Choose a folder for playback.

All

Current

### Hide image

Select/set Hide or reveal images. Hidden images are displayed only in the “Hide image” menu and cannot be played back.

Deselect all

### Playback display options

Basic photo info Choose the information available in the playback photo information display (☞ 229).

Focus point

Additional photo info

None (image only)

Highlights

RGB histogram

Shooting data

Overview



<b>Copy image(s)</b>	
Select source	Copy pictures from one memory card to another. This option is only available when two memory cards are inserted in the camera.
Select image(s)	
Select destination folder	
Copy image(s)?	
<b>Image review</b> (defaults to <b>Off</b> )	
On	Choose whether pictures are automatically displayed in the monitor immediately after shooting (☐ 225).
Off	
<b>After delete</b> (defaults to <b>Show next</b> )	
Show next	Choose the picture displayed after an image is deleted.
Show previous	
Continue as before	
<b>After burst, show</b> (defaults to <b>Last image in burst</b> )	
First image in burst	Choose whether the camera displays the first or the last photo in the burst after photos are taken in continuous release mode.
Last image in burst	
<b>Auto image rotation</b> (defaults to <b>On</b> )	
On	Choose whether to record camera orientation when taking photographs.
Off	
<b>Rotate tall</b> (defaults to <b>On</b> )	
On	Choose whether to rotate “tall” (portrait-orientation) pictures for display during playback (☐ 225).
Off	
<b>Slide show</b>	
Start	View a slide show of the pictures in the current playback folder.
Image type	
Frame interval	
<b>Select to send to smart device</b>	
Select image(s)	Select photos for upload to a smart device (☐ 244).
Deselect all	

## The Photo Shooting Menu: *Shooting Options*

### Photo shooting menu bank

A–D	Recall photo shooting menu settings previously stored in a photo shooting menu bank. Changes to settings are stored in the current bank.
-----	--

### Extended photo menu banks (defaults to **Off**)

On	Choose whether photo shooting menu banks store exposure mode, shutter speed (exposure modes <b>S</b> and <b>M</b> ), aperture (modes <b>A</b> and <b>M</b> ), and flash mode.
Off	

### Storage folder

Rename	Select the folder in which subsequent images will be stored.
Select folder by number	
Select folder from list	

### File naming

File naming	Choose the three-letter prefix used in naming the image files in which photographs are stored. The default prefix is “DSC”.
-------------	---

### Primary slot selection (defaults to **XQD card slot**)

XQD card slot	Choose the slot that serves as the primary slot when two memory cards are inserted.
SD card slot	

### Secondary slot function (defaults to **Overflow**)

Overflow	Choose the role played by the card in the secondary slot when two memory cards are inserted (☐ 93).
Backup	
RAW primary - JPEG secondary	

## Flash control

Flash control mode	Choose the flash control mode for optional flash units mounted on the camera accessory shoe or adjust settings for off-camera flash photography (□ 190).
Wireless flash options	
Remote flash control	
Radio remote flash info	

## Image area

Choose image area	Choose the image area (□ 83) and enable or disable the viewfinder mask display (□ 85).
Auto DX crop	
Viewfinder mask display	

## Image quality

(defaults to **JPEG normal**)

NEF (RAW) + JPEG fine ★	Choose a file format and compression ratio (image quality, □ 88). The compression for options indicated by a star (“★”) prioritizes quality, while that for images without a star gives priority to reducing file size.
NEF (RAW) + JPEG fine	
NEF (RAW) + JPEG normal ★	
NEF (RAW) + JPEG normal	
NEF (RAW) + JPEG basic ★	
NEF (RAW) + JPEG basic	
NEF (RAW)	
JPEG fine ★	
JPEG fine	
JPEG normal ★	
JPEG normal	
JPEG basic ★	
JPEG basic	
TIFF (RGB)	

## Image size

JPEG/TIFF	Choose the image size, in pixels (□ 91). Separate options are available for JPEG/TIFF and for NEF (RAW) images.
NEF (RAW)	

<b>NEF (RAW) recording</b>	
NEF (RAW) compression	Choose the type of compression and the bit depth for NEF (RAW) images (☞ 90).
NEF (RAW) bit depth	
<b>ISO sensitivity settings</b>	
ISO sensitivity	Adjust ISO sensitivity settings for photographs (☞ 119, 121).
Auto ISO sensitivity control	
<b>White balance</b> (defaults to <b>Auto</b> )	
Auto	Match white balance to the light source (☞ 156).
Natural light auto	
Incandescent	
Fluorescent	
Direct sunlight	
Flash	
Cloudy	
Shade	
Choose color temp.	
Preset manual	
<b>Set Picture Control</b> (defaults to <b>Auto</b> )	
Auto	Choose how new photos will be processed. Select according to the type of scene or your creative intent (☞ 175).
Standard	
Neutral	
Vivid	
Monochrome	
Portrait	
Landscape	
Flat	
<b>Manage Picture Control</b>	
Save/edit	Create custom Picture Controls.
Rename	
Delete	
Load/save	

<b>Color space</b> (defaults to <b>sRGB</b> )	
sRGB	Choose a color space for photographs.
Adobe RGB	
<b>Active D-Lighting</b> (defaults to <b>Off</b> )	
Auto	Preserve details in highlights and shadows, creating photographs with natural contrast (☐ 180).
Extra high	
High	
Normal	
Low	
Off	
<b>Long exposure NR</b> (defaults to <b>Off</b> )	
On	Reduce “noise” (bright spots or fog) in photos taken at slow shutter speeds.
Off	
<b>High ISO NR</b> (defaults to <b>Normal</b> )	
High	Reduce “noise” (randomly-spaced bright pixels) in photos taken at high ISO sensitivities.
Normal	
Low	
Off	
<b>Vignette control</b> (defaults to <b>Normal</b> )	
High	Reduce the drop in brightness at the edges of photographs when using type G, E, and D lenses (PC lenses excluded). The effect is most noticeable at maximum aperture.
Normal	
Low	
Off	
<b>Auto distortion control</b> (defaults to <b>Off</b> )	
On	Reduce barrel distortion when shooting with wide-angle lenses and to reduce pin-cushion distortion when shooting with long lenses.
Off	

## Flicker reduction

Flicker reduction setting	These options take effect during viewfinder photography. Select <b>Enable</b> for <b>Flicker reduction setting</b> to adjust shot timing to reduce the effects of flicker under fluorescent or mercury vapor lighting. <b>Flicker reduction indicator</b> controls the display of the <b>FLICKER</b> icon in the viewfinder: if <b>On</b> is selected, the icon will be displayed if flicker is detected when the shutter-release button is pressed halfway and will flash if flicker is detected with <b>Disable</b> is selected for <b>Flicker reduction setting</b> (to enable flicker reduction, select <b>Enable</b> ).
Flicker reduction indicator	

## Auto bracketing set (defaults to **AE & flash bracketing**)

AE & flash bracketing	Choose the setting or settings bracketed when auto bracketing is in effect (□ 142).
AE bracketing	
Flash bracketing	
WB bracketing	
ADL bracketing	

## Multiple exposure

Multiple exposure mode	Record from two to ten NEF (RAW) exposures as a single photograph. More information can be found in the <i>Menu Guide</i> available for download from the Nikon website (□ i).
Number of shots	
Overlay mode	
Keep all exposures	
Select first exposure (NEF)	

## HDR (high dynamic range)

HDR mode	Preserve details in highlights and shadows when photographing high-contrast scenes (□ 182).
Exposure differential	
Smoothing	

### Interval timer shooting

Start	Take photographs at the selected interval until the specified number of shots has been recorded. More information can be found in the <i>Menu Guide</i> available for download from the Nikon website (□ i).
Choose start day/time	
Interval	
Intervals×shots/interval	
Exposure smoothing	
Silent photography	
Interval priority	
Starting storage folder	

### Focus shift shooting

Start	Automatically vary focus over a series of photographs (□ 212).
No. of shots	
Focus step width	
Interval until next shot	
Exposure smoothing	
Silent photography	
Starting storage folder	

### Silent live view photography

(defaults to **Off**)

On (Mode 1)	Eliminate the sound of the shutter during live view photography (□ 49).
On (Mode 2)	
Off	

## The Movie Shooting Menu: *Movie Shooting Options*

### Reset movie shooting menu

Yes	Select <b>Yes</b> to restore movie shooting menu options to their default values.
No	

### File naming

Choose the three-letter prefix used in naming the image files in which movies are stored. The default prefix is "DSC".

### Destination (defaults to **XQD card slot**)

XQD card slot	Choose the slot to which movies are recorded.
SD card slot	

### Image area

Choose image area	Choose the image area (📄 68).
Auto DX crop	

### Frame size/frame rate (defaults to **1920×1080; 60p**)

3840×2160; 30p	Choose movie frame size (in pixels) and frame rate (📄 69).
3840×2160; 25p	
3840×2160; 24p	
1920×1080; 60p	
1920×1080; 50p	
1920×1080; 30p	
1920×1080; 25p	
1920×1080; 24p	
1280× 720; 60p	
1280× 720; 50p	
1920×1080; 30p ×4 (slow-mo)	
1920×1080; 25p ×4 (slow-mo)	
1920×1080; 24p ×5 (slow-mo)	



<b>Movie quality</b>	(defaults to <b>High quality</b> )
High quality	Choose movie quality (□ 69).
Normal	
<b>Movie file type</b>	(defaults to <b>MOV</b> )
MOV	Choose the movie file type.
MP4	
<b>ISO sensitivity settings</b>	
Maximum sensitivity	Adjust ISO sensitivity settings for
Auto ISO control (mode M)	movies.
ISO sensitivity (mode M)	
<b>White balance</b>	(defaults to <b>Same as photo settings</b> )
Same as photo settings	Choose the white balance for movies
Auto	(□ 156). Select <b>Same as photo</b>
Natural light auto	<b>settings</b> to use the option currently
Incandescent	selected for photos.
Fluorescent	
Direct sunlight	
Cloudy	
Shade	
Choose color temp.	
Preset manual	
<b>Set Picture Control</b>	(defaults to <b>Same as photo settings</b> )
Same as photo settings	Choose a Picture Control for movies
Auto	(□ 175). Select <b>Same as photo</b>
Standard	<b>settings</b> to use the option currently
Neutral	selected for photos.
Vivid	
Monochrome	
Portrait	
Landscape	
Flat	

<b>Manage Picture Control</b>	
Save/edit	Create custom Picture Controls.
Rename	
Delete	
Load/save	
<b>Active D-Lighting</b> (defaults to <b>Off</b> )	
Same as photo settings	Preserve details in highlights and shadows, creating movies with natural contrast (☐ 180). Select <b>Same as photo settings</b> to use the option currently selected for photos.
Extra high	
High	
Normal	
Low	
Off	
<b>High ISO NR</b> (defaults to <b>Normal</b> )	
High	Reduce “noise” (randomly-spaced bright pixels) in movies recorded at high ISO sensitivities.
Normal	
Low	
Off	
<b>Flicker reduction</b> (defaults to <b>Auto</b> )	
Auto	Reduce flicker and banding caused by fluorescent or mercury-vapor lighting during live view (☐ 37) and movie recording (☐ 59).
50 Hz	
60 Hz	
<b>Microphone sensitivity</b> (defaults to <b>Auto sensitivity</b> )	
Auto sensitivity	Turn the built-in or external microphones (☐ 296) on or off or adjust microphone sensitivity.
Manual sensitivity	
Microphone off	

<b>Attenuator</b> (defaults to <b>Disable</b> )	
Enable	Reduce microphone gain and prevent audio distortion when recording movies in loud environments.
Disable	
<b>Frequency response</b> (defaults to <b>Wide range</b> )	
Wide range	Choose the frequency response for the built-in and external microphones (□ 296).
Vocal range	
<b>Wind noise reduction</b> (defaults to <b>Off</b> )	
On	Choose whether to enable the built-in microphone's low-cut filter to reduce wind noise.
Off	
<b>Electronic VR</b> (defaults to <b>Off</b> )	
On	Choose whether to enable electronic vibration reduction in movie mode.
Off	
<b>Time-lapse movie</b>	
Start	The camera automatically takes photos at selected intervals to create a silent time-lapse movie. More information can be found in the <i>Menu Guide</i> available for download from the Nikon website (□ i).
Interval	
Shooting time	
Exposure smoothing	
Silent photography	
Image area	
Frame size/frame rate	
Interval priority	

## Custom Settings: Fine-Tuning Camera Settings

### Custom settings bank

A–D	Recall Custom Settings previously stored in a Custom Settings menu bank. Changes to settings are stored in the current bank.
-----	--

### a Autofocus

#### a1 AF-C priority selection (defaults to **Release**)

Release	When <b>AF-C</b> is selected for viewfinder photography, this option controls whether photographs can be taken whenever the shutter-release button is pressed ( <i>release priority</i> ) or only when the camera is in focus ( <i>focus priority</i> ).
Focus + release	
Release + focus	
Focus	

#### a2 AF-S priority selection (defaults to **Focus**)

Release	When <b>AF-S</b> is selected for viewfinder photography, this option controls whether photographs can be taken only when the camera is in focus ( <i>focus priority</i> ) or whenever the shutter-release button is pressed ( <i>release priority</i> ).
Focus	

#### a3 Focus tracking with lock-on



Blocked shot AF response	Control how autofocus adjusts to changes in the distance to the subject when <b>AF-C</b> is selected for viewfinder photography.
Subject motion	

#### a4 3D-tracking face-detection (defaults to **Off**)

On	Choose whether the camera detects and focuses on faces when 3D-tracking is selected for AF-area mode (☐ 100).
Off	

<b>a5 3D-tracking watch area</b> (defaults to <b>Normal</b> )	
Wide	Choose the area monitored by pressing the shutter-release button halfway when 3D-tracking is selected for AF-area mode (□ 100).
Normal	
<b>a6 Number of focus points</b> (defaults to <b>55 points</b> )	
55 points	Choose the number of focus points available for manual focus-point selection in the viewfinder.
15 points	
<b>a7 Store by orientation</b> (defaults to <b>Off</b> )	
Focus point	Choose whether the viewfinder stores the focus points and AF-area mode for vertical and horizontal orientations separately.
Focus point and AF-area mode	
Off	
<b>a8 AF activation</b> (defaults to <b>Shutter/AF-ON</b> )	
Shutter/AF-ON	Choose whether the camera focuses when the shutter-release button is pressed halfway. If <b>AF-ON only</b> is selected, the camera will not focus when the shutter-release button is pressed halfway.
AF-ON only	
<b>a9 Limit AF-area mode selection</b>	
Single-point AF	Choose the AF-area modes that can be selected using the AF-mode button and sub-command dial in viewfinder photography (□ 100).
Dynamic-area AF (9 points)	
Dynamic-area AF (25 points)	
Dynamic-area AF (72 points)	
Dynamic-area AF (153 points)	
3D-tracking	
Group-area AF	
Auto-area AF	

<b>a10 Autofocus mode restrictions</b>		(defaults to <b>No restrictions</b> )
AF-S	Choose the autofocus modes available in viewfinder photography (☐ 98).	
AF-C		
No restrictions		
<b>a11 Focus point wrap-around</b>		(defaults to <b>No wrap</b> )
Wrap	Choose whether viewfinder focus-point selection “wraps around” from one edge of the display to another.	
No wrap		
<b>a12 Focus point options</b>		
Focus point illumination	Adjust settings for the focus-point display in the viewfinder.	
Manual focus mode		
Dynamic-area AF assist		
<b>a13 Manual focus ring in AF mode</b>		(defaults to <b>Enable</b> )
Enable	This option is available with compatible lenses. Select <b>Disable</b> to disable focus using the focus ring in autofocus mode.	
Disable		
<b>b Metering/exposure</b>		
<b>b1 ISO sensitivity step value</b>		(defaults to <b>1/3 step</b> )
1/3 step	Select the increments used when making adjustments to ISO sensitivity.	
1/2 step		
1 step		
<b>b2 EV steps for exposure cntrl</b>		(defaults to <b>1/3 step</b> )
1/3 step	Select the increments used when making adjustments to shutter speed, aperture, and bracketing.	
1/2 step		
1 step		
<b>b3 Exp./flash comp. step value</b>		(defaults to <b>1/3 step</b> )
1/3 step	Select the increments used when making adjustments to exposure and flash compensation.	
1/2 step		
1 step		

<b>b4 Easy exposure compensation</b> (defaults to <b>Off</b> )	
On (Auto reset)	Choose whether exposure compensation can be adjusted solely by rotating a command dial, without pressing the  button.
On	
Off	
<b>b5 Matrix metering</b> (defaults to <b>Face detection on</b> )	
Face detection on	Choose <b>Face detection on</b> to enable face detection when shooting portraits with matrix metering during viewfinder photography (  124).
Face detection off	
<b>b6 Center-weighted area</b> (defaults to $\phi$ <b>12 mm</b> )	
$\phi$ 8 mm– $\phi$ 20 mm, Average	Choose the size of the area given the most weight when center-weighted metering is used in viewfinder photography. If a non-CPU or AF-S Fisheye NIKKOR 8–15mm f/3.5–4.5E ED lens is attached, the size of the area is fixed at 12 mm.
<b>b7 Fine-tune optimal exposure</b> (defaults to <b>No</b> )	
Yes	Fine-tune exposure for each metering method. Higher values produce brighter exposures, lower values darker exposures.
No	
<b>c Timers/AE lock</b>	
<b>c1 Shutter-release button AE-L</b> (defaults to <b>Off</b> )	
On (half press)	Choose whether exposure locks when the shutter-release button is pressed.
On (burst mode)	
Off	
<b>c2 Standby timer</b> (defaults to <b>6 s</b> )	
4 s–30 min, No limit	Choose how long the camera continues to meter exposure when no operations are performed (  34).

<b>c3 Self-timer</b>	
Self-timer delay	Choose the length of the shutter release delay, the number of shots taken, and the interval between shots in self-timer mode.
Number of shots	
Interval between shots	
<b>c4 Monitor off delay</b>	
Playback	Choose how long the monitor remains on when no operations are performed.
Menus	
Information display	
Image review	
Live view	
<b>d Shooting/display</b>	
<b>d1 CL mode shooting speed</b> (defaults to <b>5 fps</b> )	
6 fps–1 fps	Choose the frame advance rate for <b>CL</b> mode. Note that the rate may change depending on the power source (☞ 114).
<b>d2 Max. continuous release</b> (defaults to <b>200</b> )	
1–200	Choose the maximum number of shots that can be taken in a single burst in continuous release mode.
<b>d3 ISO display</b> (defaults to <b>Show frame count</b> )	
Show ISO sensitivity	Choose whether ISO sensitivity is displayed in the control panel in place of the number of exposures remaining.
Show frame count	
<b>d4 Sync. release mode options</b> (defaults to <b>Sync</b> )	
Sync	Choose whether the shutter releases on remote cameras synchronize with the shutter release on the master camera.
No sync	
<b>d5 Exposure delay mode</b> (defaults to <b>Off</b> )	
3 s–0.2 s, Off	In situations in which the slightest camera movement can blur pictures, shutter release can be delayed until approximately 0.2 to 3 seconds after the mirror is raised.



<b>d6 Electronic front-curtain shutter</b> (defaults to <b>Disable</b> )	
Enable	Enable or disable the electronic front-curtain shutter in <b>Q</b> , <b>Qc</b> , or <b>MuP</b> mode, eliminating blur caused by shutter motion. A mechanical shutter is used in other release modes, regardless of the option selected.
Disable	
<b>d7 File number sequence</b> (defaults to <b>On</b> )	
On	Choose how the camera assigns file numbers.
Off	
Reset	
<b>d8 Peaking highlight color</b> (defaults to <b>Red</b> )	
Red	Choose the highlight color for focus peaking. Peaking can be turned on or off and its sensitivity adjusted by pressing the <b>i</b> button during live view and selecting <b>Peaking level</b> (□ 45, 65).
Yellow	
Blue	
White	
<b>d9 Viewfinder grid display</b> (defaults to <b>Off</b> )	
On	Choose whether to display a framing grid in the viewfinder.
Off	
<b>d10 LCD illumination</b> (defaults to <b>Off</b> )	
On	Choose whether the control panel and button backlights are illuminated while the standby timer is active.
Off	

### **The Electronic Front-Curtain Shutter**

A type G, E, or D lens is recommended; select **Disable** if you notice lines or fog when shooting with other lenses. The fastest shutter speed and maximum ISO sensitivity available with the electronic front-curtain shutter are  $\frac{1}{2000}$  s and ISO 25600, respectively.

<b>d11 Live view in continuous mode</b> (defaults to <b>On</b> )	
On	Choose whether full-frame playback is available during burst shooting (release modes <b>Cl</b> , <b>Ch</b> , and <b>Qc</b> ) in live view (☞ 37). If <b>Off</b> is selected, not only the monitor but also the monitor backlight will turn off during exposures.
Off	
<b>d12 Optical VR</b> (defaults to <b>On</b> )	
On	Turn vibration control on or off. This item is available only with lenses that support it.
Off	
<b>e Bracketing/flash</b>	
<b>e1 Flash sync speed</b> (defaults to <b>1/250 s</b> )	
1/250 s (Auto FP), 1/250 s–1/60 s	Choose a flash sync speed.
<b>e2 Flash shutter speed</b> (defaults to <b>1/60 s</b> )	
1/60 s–30 s	Choose the slowest shutter available when the flash is used in modes <b>P</b> and <b>A</b> .
<b>e3 Exposure comp. for flash</b> (defaults to <b>Entire frame</b> )	
Entire frame	Choose how the camera adjusts flash level when exposure compensation is used.
Background only	

### 🔧 Fixing Shutter Speed at the Flash Sync Speed Limit

To fix shutter speed at the sync speed limit in shutter-priority auto or manual exposure modes, select the next shutter speed after the slowest possible shutter speed (30 s or -). An X (flash sync indicator) will be displayed in the viewfinder and control panel.





### 🔧 Auto FP High-Speed Sync

Auto FP high-speed sync allows the flash to be used at the highest shutter speed supported by the camera, making it possible to choose the maximum aperture for reduced depth of field even when the subject is backlit in bright sunlight. The information display flash mode indicator shows “FP” when auto FP high-speed sync is active.

<b>e4 Auto ↕ ISO sensitivity control</b> (defaults to <b>Subject and background</b> )	
Subject and background	Choose whether auto ISO sensitivity control for flash photography is adjusted to correctly expose both the subject and background or the main subject only.
Subject only	
<b>e5 Modeling flash</b> (defaults to <b>On</b> )	
On	Choose whether optional CLS-compatible flash units (☐ 288) emit a modeling flash when the camera <b>Pv</b> button is pressed during viewfinder photography.
Off	
<b>e6 Auto bracketing (mode M)</b> (defaults to <b>Flash/speed</b> )	
Flash/speed	Choose the settings affected when exposure/flash bracketing is enabled in exposure mode <b>M</b> .
Flash/speed/aperture	
Flash/aperture	
Flash only	
<b>e7 Bracketing order</b> (defaults to <b>MTR &gt; under &gt; over</b> )	
MTR > under > over	Choose the bracketing order for exposure, flash, and white balance bracketing.
Under > MTR > over	

## f Controls

### f1 Custom control assignment

Preview button	Choose the roles assigned to camera controls, either alone or in combination with the command dials.
Preview button + 	
Fn1 button	
Fn1 button + 	
Fn2 button	
AF-ON button	
Sub-selector	
Sub-selector center	
Sub-selector center + 	
BKT button + 	
Movie record button + 	
Lens focus function buttons	

### f2 Multi selector center button

Shooting mode	Choose the role played by the center of the multi selector.
Playback mode	
Live view	

### f3 Shutter spd & aperture lock

Shutter speed lock	Lock shutter speed at the value currently selected in mode <b>S</b> or <b>M</b> , or aperture at the value currently selected in mode <b>A</b> or <b>M</b> .
Aperture lock	

#### f4 Customize command dials

Reverse rotation	Choose the roles played by the main and sub-command dials.
Change main/sub	
Aperture setting	
Menus and playback	
Sub-dial frame advance	





#### f5 Multi selector (defaults to **Do nothing**)

Restart standby timer	Choose whether using the multi selector activates the standby timer (☐ 34).
Do nothing	

#### f6 Release button to use dial (defaults to **No**)

Yes	Selecting <b>Yes</b> allows adjustments that are normally made by holding a button and rotating a command dial to be made by rotating the command dial after the button is released. Setting ends when the button is pressed again, the shutter-release button is pressed halfway, or the standby timer expires.
No	



#### f7 Reverse indicators (defaults to )

	If  (-0+) is selected, the exposure indicators in the control panel, viewfinder, and information display are displayed with negative values on the left and positive values on the right. Select  (+0-) to display positive values on the left and negative values on the right.
	



**f8 Live view button options** (defaults to **Enable**)

Enable	The  button can be disabled to prevent live view starting accidentally.
Enable (standby timer active)	
Disable	





**f9  switch** (defaults to **LCD backlight ()**)

LCD backlight (  )  and information display	Choose displays illuminated by rotating the power switch to  .
--	---

**f10 Assign MB-D18 buttons**

Fn button	Choose the functions assigned to the controls on the optional MB-D18 multi-power battery pack (  299).
Fn button + 	
AF-ON button	
Multi selector	

**g Movie****g1 Custom control assignment**

Preview button	Choose the roles assigned to camera controls, either alone or in combination with the command dials, when the live view selector is rotated to  in live view. Note that if <b>Record movies</b> is selected for <b>Shutter-release button</b> , the shutter-release button cannot be used for any operation other than recording movies.
Preview button + 	
Fn1 button	
Fn1 button + 	
Fn2 button	
Sub-selector center	
Sub-selector center + 	
Shutter-release button	

**g2 Highlight brightness** (defaults to **248**)

255–180	Choose the brightness needed to trigger the movie highlight display. The lower the value, the greater the range of brightnesses that will be shown as highlights. If <b>255</b> is selected, the highlight display will show only areas that are potentially overexposed.
---------	---

## The Setup Menu: *Camera Setup*

### Format memory card

XQD card slot

SD card slot

To begin formatting, choose a memory card slot and select **Yes**. *Note that formatting permanently deletes all pictures and other data on the card in the selected slot.* Before formatting, be sure to make backup copies as required.

### Language

See page 345.

Choose a language for camera menus and messages.

### Time zone and date

Time zone

Date and time

Sync with smart device

Date format

Daylight saving time

Change time zones, set the camera clock, synchronize the clock with the clock on a smart device, choose the date display order, and turn daylight saving time on or off. If **On** is selected for **Sync with smart device** and synchronization is enabled in the SnapBridge app, the camera clock can be set to the time provided by the smart device.

### Monitor brightness



Menus/playback

Live view

Adjust the brightness of the menu, playback, and live view displays.

### Formatting Memory Cards

Do not turn the camera off or remove the battery or memory cards during formatting.

In addition to the **Format memory card** option in the setup menu, memory cards can be formatted using the **ISO** () and **FORMAT** () buttons: keep both buttons pressed simultaneously until formatting indicators are displayed and then press the buttons again to format the card. If two memory cards are inserted when the buttons are first pressed, the card to be formatted will be shown by a flashing icon. Rotate the main command dial to choose a different slot.

<b>Monitor color balance</b>	
	Adjust monitor color balance.
<b>Virtual horizon</b>	
	View a virtual horizon based on information from the camera tilt sensor.
<b>Information display</b> (defaults to <b>Auto</b> )	
Auto	Adjust the information display for different viewing conditions.
Manual	
<b>AF fine-tune</b>	
AF fine-tune (On/Off)	Fine-tune focus for different lens types.
Saved value	AF tuning is not recommended in most situations and may interfere with normal focus; use only when required.
Default	Auto fine-tuning is available in live view; more information is available in a <i>Menu Guide</i> that can be downloaded from the Nikon website (☞ i).
List saved values	
<b>Non-CPU lens data</b>	
Lens number	Record the focal length and maximum aperture of non-CPU lenses, allowing them to be used with functions normally reserved for CPU lenses (☞ 218).
Focal length (mm)	
Maximum aperture	
<b>Clean image sensor</b>	
Clean now	Vibrate the image sensor to remove dust (☞ 312).
Clean at startup/shutdown	
<b>Lock mirror up for cleaning</b>	
	Lock the mirror up so that dust can be removed from the image sensor with a blower (☞ 315). Not available when the battery is low (☞ or lower) or when the camera is connected to a smart device via Bluetooth or to other devices via USB.



### Image Dust Off ref photo

Start	Acquire reference data for the Image Dust Off option in Capture NX-D (□ ii).
Clean sensor and then start	





### Image comment

Attach comment	Add a comment to new photographs as they are taken. Comments can be viewed as metadata in ViewNX-i or Capture NX-D (□ ii).
Input comment	

### Copyright information

Attach copyright information	Add copyright information to new photographs as they are taken. Copyright information can be viewed as metadata in ViewNX-i or Capture NX-D (□ ii).
Artist	
Copyright	

### Text Entry

A keyboard is displayed when text entry is required. Enter text by tapping the characters on the touch screen (to cycle through the upper- and lower-case and symbol keyboards, tap the keyboard selection button). You can also use the multi selector to highlight the desired character in the keyboard area and press the center of the multi selector to insert the highlighted character at the current cursor position (note that if a character is entered when the field is full, the last character in the field will be deleted). To delete the character under the cursor, press the  (FORMX) button. To move the cursor to a new position, tap the display or hold the  button and press  or . To complete entry and return to the previous menu, press .



Keyboard area

Keyboard selection

<b>Beep options</b>	
Beep on/off	Choose the pitch and volume of the beep.
Volume	
Pitch	
<b>Touch controls</b>	
Enable/disable touch controls	Adjust touch control settings (📖 12).
Full-frame playback flicks	
<b>HDMI</b>	
Output resolution	Adjust settings for connection to HDMI devices.
External recording control	
Advanced	
<b>Location data</b>	
Download from smart device	Adjust location data settings (📖 221).
Position	
External GPS device options	
<b>Wireless remote (WR) options</b>	
LED lamp	Adjust LED lamp and link mode settings for optional wireless remote controllers.
Link mode	
<b>Assign remote (WR) Fn button</b> (defaults to <b>None</b> )	
Preview	Choose the role played by the <b>Fn</b> button on optional wireless remote controllers.
FV lock	
AE/AF lock	
AE lock only	
AE lock (Reset on release)	
AF lock only	
AF-ON	
🔌 Disable/enable	
+ NEF (RAW)	
Live view	
None	

<b>Airplane mode</b>		(defaults to <b>Disable</b> )
Enable	<p>Enable airplane mode to disable the wireless features of Eye-Fi cards and Bluetooth and Wi-Fi connections to smart devices. Connections to other devices using a wireless transmitter can only be disabled by removing the transmitter from the camera.</p>	
Disable		
<b>Connect to smart device</b>		
Start	<p>Pair the camera to a smart device running the SnapBridge app as described in the supplied <i>SnapBridge Connection Guide (for D-SLR Cameras)</i>.</p>	
Password protection		
<b>Send to smart device (auto)</b>		(defaults to <b>Off</b> )
On	<p>Select <b>On</b> to upload photos to a smart device as they are taken.</p>	
Off		
<b>Wi-Fi</b>		
Network settings	<p>Adjust Wi-Fi (wireless LAN) settings for connection to smart devices.</p>	
Current settings		
Reset connection settings		
<b>Bluetooth</b>		
Network connection	<p>Adjust settings for Bluetooth connections to smart devices. The camera can be paired with up to five smart devices but can only connect to one at a time.</p>	
Paired devices		
Send while off		
<b>Network</b>		
Choose hardware	<p>Adjust ftp and network settings for Ethernet and wireless LANs using a WT-7. This option is available only when a WT-7 is attached.</p>	
Network settings		
Options		

<b>Eye-Fi upload</b> (defaults to <b>Enable</b> )	
Enable	Upload pictures to a preselected destination. This option is displayed only when a supported Eye-Fi card is inserted.
Disable	
<b>Conformity marking</b>	
	View a selection of the standards with which the camera complies.
<b>MB-D18 battery type</b> (defaults to <b>LR6 (AA alkaline)</b> )	
LR6 (AA alkaline)	To ensure that the camera functions as expected when the optional MB-D18 multi-power battery pack is used with AA batteries, match the option selected in this menu to the type of batteries inserted in the battery pack.
HR6 (AA Ni-MH)	
FR6 (AA lithium)	
<b>Battery order</b> (defaults to <b>Use MB-D18 batteries first</b> )	
Use MB-D18 batteries first	Choose whether the battery in the camera or the batteries in the battery pack are used first when an optional MB-D18 multi-power battery pack is attached.
Use camera battery first	
<b>Battery info</b>	
	View information on the battery currently inserted in the camera.
<b>Slot empty release lock</b> (defaults to <b>Enable release</b> )	
Release locked	Choose whether the shutter can be released when no memory card is inserted.
Enable release	

### Save/load settings

Save settings	Save camera settings to or load camera settings from a memory card. Settings files can be shared with other D850 cameras.
Load settings	

### Reset all settings

Reset	Reset all settings apart from the options selected for <b>Language</b> and <b>Time zone and date</b> in the setup menu.
Do not reset	

### Firmware version

View the current camera firmware version.

#### **Reset All Settings**

Copyright information and other user-generated entries are also reset. We recommend that you save settings using the **Save/load settings** option in the setup menu before performing a reset.

## **The Retouch Menu:** ***Creating Retouched Copies***

### **NEF (RAW) processing**

Select image(s)	Create JPEG copies of NEF (RAW) photographs.
Select date	
Select all images	
Choose destination	

### **Trim**

Create a cropped copy of the selected photograph.

### **Resize**

Select image(s)	Create small copies of selected photographs.
Choose destination	
Choose size	

### **D-Lighting**

Brighten shadows. Choose for dark or backlit photographs.

### **Red-eye correction**

Correct “red-eye” in photos taken with a flash.

### **Straighten**

Create straightened copies. Copies can be straightened by up to 5° in increments of approximately 0.25°.

### **Distortion control**

Auto	Create copies with reduced peripheral distortion. Use to reduce barrel distortion in photos taken with wide-angle lenses or pin-cushion distortion in photos taken with telephoto lenses. Select <b>Auto</b> to let the camera correct distortion automatically.
Manual	

## Perspective control

Create copies that reduce the effects of perspective taken from the base of a tall object.

## Filter effects

Skylight

Warm filter

Create the effects of the following filters:

- **Skylight:** A skylight filter effect
- **Warm filter:** A warm tone filter effect

## Monochrome

Black-and-white

Sepia

Cyanotype

Copy photographs in **Black-and-white**, **Sepia**, or **Cyanotype** (blue and white monochrome).



## Image overlay

Image overlay combines two existing NEF (RAW) photographs to create a single picture that is saved separately from the originals. **Image overlay** can only be selected by pressing **MENU** and selecting  tab.

## Trim movie

Trim footage to create edited copies of movies ( 78).

## Side-by-side comparison

Compare retouched copies to the original photographs. **Side-by-side comparison** is only available if the retouch menu is displayed by pressing  while pressing and holding the  button or by pressing **i** and selecting **Retouch** in full-frame playback when a retouched image or original is displayed.

## My Menu / Recent Settings

### Add items

PLAYBACK MENU	Create a custom menu of up to 20 items selected from the playback, photo shooting, movie shooting, Custom Setting, setup, and retouch menus.
PHOTO SHOOTING MENU	
MOVIE SHOOTING MENU	
CUSTOM SETTING MENU	
SETUP MENU	
RETOUCH MENU	

### Remove items

Delete items from My Menu.

### Rank items

Rank items in My Menu.

### Choose tab

(defaults to **MY MENU**)





MY MENU	Choose the menu displayed in the “My Menu/Recent Settings” tab. Select <b>RECENT SETTINGS</b> to display a menu listing the 20 most recently-used settings.
RECENT SETTINGS	







# Technical Notes

Read this chapter for information on compatible accessories, cleaning and storing the camera, and what to do if an error message is displayed or you encounter problems using the camera.

## Compatible Lenses

Camera setting  Lens/accessory		Focus mode		Exposure mode		Metering system				
		AF	M (with electronic rangefinder) <sup>1</sup>	P S	A M	 <sup>2</sup>		 <sup>3</sup>	 <sup>4</sup>	 <sup>5</sup>
						3D	Color			
CPU lenses <sup>6</sup>	Type G, E, or D <sup>7</sup> ; AF-S, AF-P, AF-I	✓	✓	✓	✓	✓	—	✓ <sup>8</sup>	✓	
	PC NIKKOR 19mm f/4E ED	—	✓ <sup>9</sup>	✓ <sup>9</sup>	✓ <sup>9</sup>	✓ <sup>9</sup>	—	✓ <sup>8,9</sup>	✓ <sup>9</sup>	
	PC-E NIKKOR series <sup>10</sup>	—	✓ <sup>9</sup>	✓ <sup>9</sup>	✓ <sup>9</sup>	✓ <sup>9</sup>	—	✓ <sup>8,9</sup>	✓ <sup>9</sup>	
	PC Micro 85mm f/2.8D <sup>10,11</sup>	—	✓ <sup>9</sup>	—	✓ <sup>12</sup>	✓ <sup>9</sup>	—	✓ <sup>8,9</sup>	✓ <sup>9</sup>	
	AF-S / AF-I Teleconverter <sup>13</sup>	✓	✓	✓	✓	✓	—	✓ <sup>8</sup>	✓	
	Other AF NIKKOR (except lenses for F3AF)	✓ <sup>14</sup>	✓ <sup>14</sup>	✓	✓	—	✓	✓ <sup>8</sup>	—	
	AI-P NIKKOR	—	✓ <sup>15</sup>	✓	✓	—	✓	✓ <sup>8</sup>	—	

Camera setting Lens/accessory		Focus mode		Exposure mode		Metering system				
		AF	M (with electronic rangefinder) <sup>1</sup>	P S	A M	 <sup>2</sup>		 <sup>3</sup>	 <sup>4</sup>	 <sup>5</sup>
						3D	Color			
Non-CPU lenses <sup>6</sup>	AI-, AI-modified NIKKOR or Nikon Series E lenses <sup>17</sup>	—	✓ <sup>15</sup>	—	✓ <sup>18</sup>	—	✓ <sup>19</sup>	✓ <sup>20</sup>	—	
	Medical-NIKKOR 120mm f/4	—	✓	—	✓ <sup>21</sup>	—	—	—	—	
	Reflex-NIKKOR	—	—	—	✓ <sup>18</sup>	—	—	✓ <sup>20</sup>	—	
	PC-NIKKOR	—	✓ <sup>9</sup>	—	✓ <sup>22</sup>	—	—	✓	—	
	AI-type Teleconverter <sup>23</sup>	—	✓ <sup>24</sup>	—	✓ <sup>18</sup>	—	✓ <sup>19</sup>	✓ <sup>20</sup>	—	
	PB-6 Bellows Focusing Attachment <sup>25</sup>	—	✓ <sup>24</sup>	—	✓ <sup>26</sup>	—	—	✓	—	
	Auto extension rings (PK-series 11A, 12, or 13; PN-11)	—	✓ <sup>24</sup>	—	✓ <sup>18</sup>	—	—	✓	—	

1 Manual focus is available with all lenses.

2 Matrix.

3 Center-weighted.

4 Spot.

5 Highlight-weighted.

6 IX-NIKKOR lenses cannot be used.

7 Vibration Reduction (VR) supported with VR lenses.

8 Spot metering meters selected focus point ( 124).

9 Cannot be used with shifting or tilting.

10 Fog, lines, and other image artifacts (“noise”) may appear in photos taken with the electronic front-curtain shutter. This can be prevented by selecting **Disable** for Custom Setting d6 (**Electronic front-curtain shutter**,  265).

11 The camera’s exposure metering and flash control systems do not work properly when shifting and/or tilting the lens, or when an aperture other than the maximum aperture is used.

12 Manual exposure mode only.

- 13 For information on the focus points available for autofocus and electronic rangefinding, see “AF-S/AF-I Teleconverters and Available Focus Points” (□ 96).
  - 14 When focusing at minimum focus distance with AF 80–200mm f/2.8, AF 35–70mm f/2.8, AF 28–85mm f/3.5–4.5 <New>, or AF 28–85mm f/3.5–4.5 lens at maximum zoom, in-focus indicator may be displayed when image on matte screen in viewfinder is not in focus. Adjust focus manually until image in viewfinder is in focus.
  - 15 With maximum aperture of f/5.6 or faster.
  - 16 Some lenses cannot be used; see “Incompatible Accessories and Non-CPU Lenses” (□ 285).
  - 17 Range of rotation for AI 80–200mm f/2.8 ED tripod mount is limited by camera body. Filters cannot be exchanged while AI 200–400mm f/4 ED is mounted on camera.
  - 18 If maximum aperture is specified using **Non-CPU lens data** (□ 218), aperture value will be displayed in viewfinder and control panel.
  - 19 Can be used only if lens focal length and maximum aperture are specified using **Non-CPU lens data** (□ 218). Use spot or center-weighted metering if desired results are not achieved.
  - 20 For improved precision, specify lens focal length and maximum aperture using **Non-CPU lens data** (□ 218).
  - 21 Can be used in manual exposure mode at shutter speeds slower than flash sync speed by one step or more.
  - 22 Exposure determined by presetting lens aperture. In aperture-priority auto exposure mode, preset aperture using lens aperture ring before performing AE lock and shifting lens. In manual exposure mode, preset aperture using lens aperture ring and determine exposure before shifting lens.
  - 23 Exposure compensation required when used with AI 28–85mm f/3.5–4.5, AI 35–105mm f/3.5–4.5, AI 35–135mm f/3.5–4.5, or AF-S 80–200mm f/2.8D.
  - 24 With maximum effective aperture of f/5.6 or faster.
  - 25 Requires PK-12 or PK-13 auto extension ring. PB-6D may be required depending on camera orientation.
  - 26 Use preset aperture. In aperture-priority auto exposure mode, set aperture using focusing attachment before determining exposure and taking photograph.
- PF-4 Reprocopy Outfit requires PA-4 Camera Holder.
  - Noise in the form of lines may appear during autofocus at high ISO sensitivities. Use manual focus or focus lock. Lines may also appear at high ISO sensitivities when aperture is adjusted during movie recording or live view photography.

### Recognizing CPU and Type G, E, and D Lenses

CPU lenses (particularly types G, E, and D) are recommended, but note that IX-NIKKOR lenses cannot be used. CPU lenses can be identified by the presence of CPU contacts, type G, E, and D lenses by a letter on the lens barrel. Type G and E lenses are not equipped with a lens aperture ring.

CPU contacts

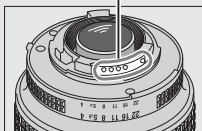

CPU lens

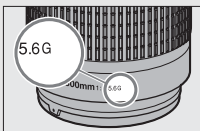

Type G/E lens

Aperture ring

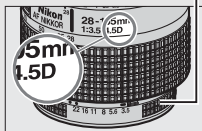

Type D lens

### Lens f-number

The f-number given in lens names is the maximum aperture of the lens.

### Compatible Non-CPU Lenses

**Non-CPU lens data** (□ 218) can be used to enable many of the features available with CPU lenses, including color matrix metering; if no data are provided, center-weighted metering will be used in place of color matrix metering, while if the maximum aperture is not provided, the camera aperture display will show the number of stops from maximum aperture and the actual aperture value must be read off the lens aperture ring.

## ❑ Incompatible Accessories and Non-CPU Lenses

The following CANNOT be used with the D850:

- TC-16A AF teleconverter
- Non-AI lenses
- Lenses that require the AU-1 focusing unit (400mm f/4.5, 600mm f/5.6, 800mm f/8, 1200mm f/11)
- Fisheye (6mm f/5.6, 7.5mm f/5.6, 8mm f/8, OP 10mm f/5.6)
- 2.1cm f/4
- Extension Ring K2
- 180–600mm f/8 ED (serial numbers 174041–174180)
- 360–1200mm f/11 ED (serial numbers 174031–174127)
- 200–600mm f/9.5 (serial numbers 280001–300490)
- AF lenses for the F3AF (AF 80mm f/2.8, AF 200mm f/3.5 ED, AF Teleconverter TC-16)
- PC 28mm f/4 (serial number 180900 or earlier)
- PC 35mm f/2.8 (serial numbers 851001–906200)
- PC 35mm f/3.5 (old type)
- Reflex 1000mm f/6.3 (old type)
- Reflex 1000mm f/11 (serial numbers 142361–143000)
- Reflex 2000mm f/11 (serial numbers 200111–200310)

## ❑ VR Lenses

The lenses listed below are not recommended for long exposures or photographs taken at high ISO sensitivities, as due to the design of the vibration reduction (VR) control system the resulting photos may be marred by fog. We recommend turning vibration reduction off when using other VR lenses.

- AF-S VR Zoom-Nikkor 24–120mm f/3.5–5.6G IF-ED
- AF-S VR Zoom-Nikkor 70–200mm f/2.8G IF-ED
- AF-S VR Zoom-Nikkor 70–300mm f/4.5–5.6G IF-ED
- AF-S VR Nikkor 200mm f/2G IF-ED
- AF-S VR Nikkor 300mm f/2.8G IF-ED
- AF-S NIKKOR 16–35mm f/4G ED VR
- AF-S NIKKOR 24–120mm f/4G ED VR
- AF-S NIKKOR 28–300mm f/3.5–5.6G ED VR
- AF-S NIKKOR 400mm f/2.8G ED VR
- AF-S NIKKOR 500mm f/4G ED VR
- AF-S DX VR Zoom-Nikkor 18–200mm f/3.5–5.6G IF-ED
- AF-S DX NIKKOR 16–85mm f/3.5–5.6G ED VR
- AF-S DX NIKKOR 18–200mm f/3.5–5.6G ED VR II
- AF-S DX Micro NIKKOR 85mm f/3.5G ED VR
- AF-S DX NIKKOR 55–300mm f/4.5–5.6G ED VR

## Calculating Angle of View

The camera can be used with Nikon lenses for 35 mm (135) format cameras. If a 35 mm format lens is attached, the angle of view will be the same as a frame of 35 mm film ( $35.9 \times 23.9$  mm).

If desired, the **Image area** option in the photo shooting menu can be used to choose an angle of view different from that of the current lens. If a 35 mm format lens is attached, you can reduce the angle of view by 1.5 $\times$  or 1.2 $\times$  by selecting **DX (24 $\times$ 16)** or **1.2 $\times$  (30 $\times$ 20)** to expose a smaller area, or change the aspect ratio by selecting **5 : 4 (30 $\times$ 24)** or **1 : 1 (24 $\times$ 24)**. The sizes of the areas exposed by different Image area options are shown below.

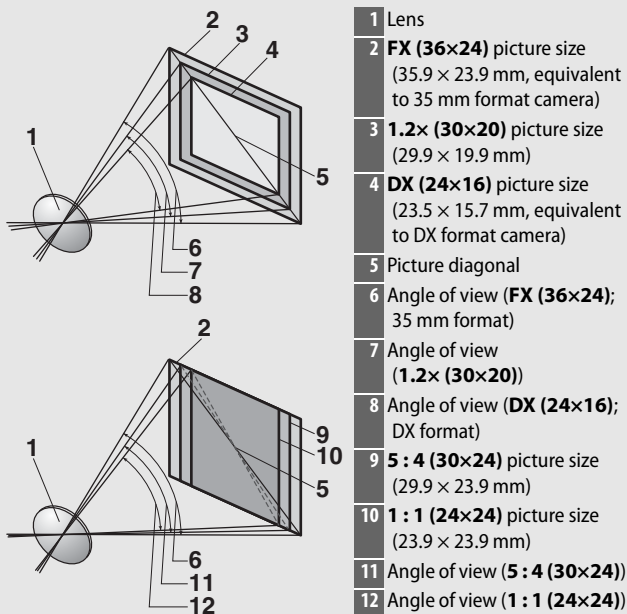

### Calculating Angle of View (Continued)

The **DX (24×16)** angle of view is about 1.5 times smaller than the 35 mm format angle of view, while the **1.2× (30×20)** angle of view is about 1.2 times smaller, the **5 : 4 (30×24)** angle of view is about 1.1 times smaller, and the **1 : 1 (24×24)** angle of view is about 1.3 times smaller. To calculate the focal length of lenses in 35 mm format, multiply the focal length of the lens by about 1.5 when **DX (24×16)** is selected, by about 1.2 when **1.2× (30×20)** is selected, by about 1.1 when **5 : 4 (30×24)** is selected, or by about 1.3 when **1 : 1 (24×24)** is selected (for example, the effective focal length of a 50mm lens in 35 mm format would be approximately 75 mm when **DX (24×16)** is selected, 60 mm when **1.2× (30×20)** is selected, 55 mm when **5 : 4 (30×24)** is selected, or 65 mm when **1 : 1 (24×24)** is selected).

## The Nikon Creative Lighting System (CLS)

Nikon's advanced Creative Lighting System (CLS) offers improved communication between the camera and compatible flash units for improved flash photography.

### ■ CLS-Compatible Flash Units





The following features are available with CLS-compatible flash units:

		SB-5000	SB-910, SB-900, SB-800	SB-700	SB-600	SB-500	SU-800	SB-R200	SB-400	SB-300	
Single flash	i-TTL	i-TTL balanced fill-flash for digital SLR <sup>1</sup>	✓	✓	✓	✓	—	—	✓	✓	
		Standard i-TTL fill-flash for digital SLR	✓ <sup>2</sup>	✓ <sup>2</sup>	✓	✓ <sup>2</sup>	✓	—	—	✓	✓
	 A	Auto aperture	✓	✓ <sup>3</sup>	—	—	—	—	—	—	—
	A	Non-TTL auto	— <sup>4</sup>	✓ <sup>3</sup>	—	—	—	—	—	—	—
	GN	Distance-priority manual	✓	✓	✓	—	—	—	—	—	—
	M	Manual	✓	✓	✓	✓	✓ <sup>5</sup>	—	—	✓ <sup>5</sup>	✓ <sup>5</sup>
	RPT	Repeating flash	✓	✓	—	—	—	—	—	—	—



		SB-5000	SB-910, SB-900, SB-800	SB-700	SB-600	SB-500	SU-800	SB-R200	SB-400	SB-300	
Optical Advanced Wireless Lighting	Master	Remote flash control	✓	✓	✓	—	✓ <sup>5</sup>	✓	—	—	
		i-TTL i-TTL	✓	✓	✓	—	✓ <sup>5</sup>	—	—	—	
		[A:B] Quick wireless flash control	✓	—	✓	—	—	✓ <sup>6</sup>	—	—	—
		⊗A Auto aperture	✓	✓	—	—	—	—	—	—	—
		A Non-TTL auto	—	— <sup>7</sup>	—	—	—	—	—	—	—
		M Manual	✓	✓	✓	—	✓ <sup>5</sup>	—	—	—	—
		RPT Repeating flash	✓	✓	—	—	—	—	—	—	—
	Remote	i-TTL i-TTL	✓	✓	✓	✓	✓	—	✓	—	—
		[A:B] Quick wireless flash control	✓	✓	✓	✓	✓	—	✓	—	—
		⊗A/A Auto aperture/ Non-TTL auto	✓ <sup>8</sup>	✓ <sup>8</sup>	—	—	—	—	—	—	—
		M Manual	✓	✓	✓	✓	✓	—	✓	—	—
		RPT Repeating flash	✓	✓	✓	✓	✓	—	—	—	—
	Radio-controlled Advanced Wireless Lighting		✓ <sup>9</sup>	—	—	—	—	—	—	—	—
	Color Information Communication (flash)		✓	✓	✓	✓	✓	—	—	✓	✓
	Color Information Communication (LED light)		—	—	—	—	✓	—	—	—	—

	SB-5000	SB-910, SB-900, SB-800	SB-700	SB-600	SB-500	SU-800	SB-R200	SB-400	SB-300
Auto FP High-Speed Sync <sup>10</sup>	✓	✓	✓	✓	✓	✓	✓	—	—
FV lock <sup>11</sup>	✓	✓	✓	✓	✓	✓	✓	✓	✓
AF-assist for multi-area AF	✓	✓	✓	✓	—	✓ <sup>12</sup>	—	—	—
Red-eye reduction	✓	✓	✓	✓	✓	—	—	✓	—
Camera modeling illumination	✓	✓	✓	✓	✓	✓	✓	—	—
Unified flash control	✓	—	—	—	✓	—	—	✓	✓
Camera flash unit firmware update	✓	✓ <sup>13</sup>	✓	—	✓	—	—	—	✓

- 1 Not available with spot metering.
- 2 Can also be selected with flash unit.
- 3  A/A mode selection performed on flash unit using custom settings. Unless lens data have been provided using the **Non-CPU lens data** option in the setup menu, “A” will be selected when a non-CPU lens is used.
- 4 Unless lens data have been provided using the **Non-CPU lens data** option in the setup menu, non-TTL auto will be selected when a non-CPU lens is used.
- 5 Can only be selected using camera **Flash control** option.
- 6 Available only during close-up photography.
- 7 Unless lens data have been provided using the **Non-CPU lens data** option in the setup menu, non-TTL auto (A) is used with non-CPU lenses, regardless of mode selected with flash unit.
- 8 Choice of  A and A depends on the option selected with master flash.
- 9 Supports the same features as remote flash units with optical AWL.
- 10 Available only in i-TTL, , A, GN, and M flash-control modes.
- 11 Available only in i-TTL flash control mode or when flash is set to emit monitor pre-flashes in  A or A flash control mode.
- 12 Available only in commander mode.
- 13 Firmware updates for the SB-910 and SB-900 can be performed from the camera.

**The SU-800 Wireless Speedlight Commander:** When mounted on a CLS-compatible camera, the SU-800 can be used as a commander for SB-5000, SB-910, SB-900, SB-800, SB-700, SB-600, SB-500, or SB-R200 flash units in up to three groups. The SU-800 itself is not equipped with a flash.

#### **Modeling Illumination**

CLS-compatible flash units emit a modeling flash when the camera **Pv** button is pressed. This feature can be used with Advanced Wireless Lighting to preview the total lighting effect achieved with multiple flash units. Modeling illumination can be turned off using Custom Setting e5 (**Modeling flash**,  267).



## ■ Other Flash Units

The following flash units can be used in non-TTL auto and manual modes.

Flash unit	SB-80DX, SB-28DX, SB-28, SB-26, SB-25, SB-24	SB-50DX	SB-30, SB-27 <sup>1</sup> , SB-22S, SB-22, SB-20, SB-16B, SB-15	SB-23, SB-29 <sup>2</sup> , SB-21B <sup>2</sup> , SB-29S <sup>2</sup>
<b>A</b> Non-TTL auto	✓	—	✓	—
<b>M</b> Manual	✓	✓	✓	✓
 Repeating flash	✓	—	—	—
<b>REAR</b> Rear-curtain sync <sup>3</sup>	✓	✓	✓	✓



- 1 Flash mode is automatically set to TTL and shutter-release is disabled. Set flash unit to **A** (non-TTL auto flash).
- 2 Autofocus is available with AF-S VR Micro-Nikkor 105mm f/2.8G IF-ED and AF-S Micro NIKKOR 60mm f/2.8G ED lenses only.
- 3 Available when camera is used to select flash mode.

### Using FV Lock with Optional Flash Units

FV lock ( 196) is available with optional flash units in TTL and (where supported) monitor pre-flash A and monitor pre-flash A flash control modes (see the manual provided with the flash unit for more information). Note that when Advanced Wireless Lighting is used to control remote flash units, you will need to set the flash control mode for the master or at least one remote group to TTL, A, or A.

### Metering

The metering areas for FV lock when using optional flash unit are as follows:

Flash unit	Flash mode	Metered area
Stand-alone flash unit	i-TTL	6-mm circle in center of frame
	 A	Area metered by flash exposure meter
Used with other flash units (Advanced Wireless Lighting)	i-TTL	Entire frame
	 A	Area metered by flash exposure meter
	A	

### **✓ Notes on Optional Flash Units**

Refer to the flash unit manual for detailed instructions. If the unit supports CLS, refer to the section on CLS-compatible digital SLR cameras. The D850 is not included in the “digital SLR” category in the SB-80DX, SB-28DX, and SB-50DX manuals.

i-TTL flash control can be used at ISO sensitivities between 64 and 12800. At values over 12800, the desired results may not be achieved at some ranges or aperture settings. If the flash-ready indicator (⚡) flashes for about three seconds after a photograph is taken in i-TTL or non-TTL auto mode, the flash has fired at full power and the photograph may be underexposed (CLS-compatible flash units only).

When an SC-series 17, 28, or 29 sync cable is used for off-camera flash photography, correct exposure may not be achieved in i-TTL mode. We recommend that you select standard i-TTL fill-flash. Take a test shot and view the results in the monitor.

In i-TTL, use the flash panel or bounce adapter provided with the flash unit. Do not use other panels such as diffusion panels, as this may produce incorrect exposure.

In exposure mode **P**, the maximum aperture (minimum f-number) is limited according to ISO sensitivity, as shown below:

<b>Maximum aperture at ISO equivalent of:</b>								
<b>64</b>	<b>100</b>	<b>200</b>	<b>400</b>	<b>800</b>	<b>1600</b>	<b>3200</b>	<b>6400</b>	<b>12800</b>
3.5	4	4.8	5.6	6.7	8	9.5	11	13



If the maximum aperture of the lens is smaller than given above, the maximum value for aperture will be the maximum aperture of the lens.

Noise in the form of lines may appear in flash photographs taken with an SD-9 or SD-8A high-performance battery pack attached directly to the camera. Reduce ISO sensitivity or increase the distance between the camera and the power pack.



### Notes on Optional Flash Units (Continued)

The SB-5000, SB-910, SB-900, SB-800, SB-700, SB-600, SB-500, and SB-400 provide red-eye reduction, while the SB-5000, SB-910, SB-900, SB-800, SB-700, SB-600, and SU-800 provide AF-assist illumination with the following restrictions:



- **SB-5000:** AF-assist illumination is available when 24–135 mm AF lenses are used with the focus points shown below.

Focal length		
24–49 mm	50–84 mm	85–135 mm
		

- **SB-910 and SB-900:** AF-assist illumination is available when 17–135 mm AF lenses are used with the focus points shown below.

Focal length	
17–19 mm	20–135 mm
	

- **SB-800, SB-600, and SU-800:** AF-assist illumination is available when 24–105 mm AF lenses are used with the focus points shown below.

Focal length		
24–34 mm	35–49 mm	50–105 mm
		

- **SB-700:** AF-assist illumination is available when 24–135 mm AF lenses are used with the focus points shown below.

Focal length	
24–27 mm	28–135 mm

Depending on the lens used and scene recorded, the in-focus indicator (●) may be displayed when the subject is not in focus, or the camera may be unable to focus and the shutter release will be disabled.

### Optional Flash Units

In i-TTL and auto aperture (A) flash control modes, the flash compensation selected with the optional flash unit or the **Flash control** option in the photo shooting menu is added to the flash compensation selected with the (⚡) button and command dial.

## Other Accessories

At the time of writing, the following accessories were available for the D850.

<b>Power sources</b>	<ul style="list-style-type: none"><li>• EN-EL15a Rechargeable Li-ion Battery/ EN-EL15 Rechargeable Li-ion Battery (□ 14, 347); note that fewer pictures can be taken on a single charge with an EN-EL15 than with an EN-EL15a (□ 365)</li><li>• MH-25a Battery Charger (□ 14, 347)</li><li>• MB-D18 Multi-Power Battery Pack</li><li>• EP-5B Power Connector, EH-5c and EH-5b AC Adapters</li></ul>
<b>Wireless transmitters</b> (□ 275)	WT-7 Wireless Transmitter
<b>Wireless remote controllers</b>	<ul style="list-style-type: none"><li>• WR-1 Wireless Remote Controller</li><li>• WR-R10 Wireless Remote Controller (requires WR-A10 WR Adapter)</li><li>• WR-T10 Wireless Remote Controller</li></ul>
<b>Viewfinder eyepiece accessories</b>	<ul style="list-style-type: none"><li>• DK-19 Rubber Eyecup</li><li>• DK-17C Diopter-Adjustment Viewfinder Lens</li><li>• DK-17M Magnifying Eyepiece</li><li>• DG-2 Eyepiece Magnifier (requires DK-18 Eyepiece Adapter)</li><li>• DK-14 Antifog Finder Eyepiece/DK-17A Antifog Finder Eyepiece</li><li>• DK-17F Fluorine-Coated Finder Eyepiece</li><li>• DR-5 Right-Angle Viewing Attachment/DR-4 Right-Angle Viewing Attachment</li></ul>
<b>HDMI cables</b>	HC-E1 HDMI Cable
<b>Accessory shoe covers</b>	BS-3 Accessory Shoe Cover/BS-1 Accessory Shoe Cover
<b>Body caps</b>	BF-1B Body Cap/BF-1A Body Cap



<b>Software</b>	Camera Control Pro 2
<b>Remote terminal accessories</b>	<ul style="list-style-type: none"> <li>• MC-22 Remote Cord/MC-22A Remote Cord (length 1 m/3 ft 4 in.*)</li> <li>• MC-30 Remote Cord/MC-30A Remote Cord (length 80 cm/2 ft 8 in.*)</li> <li>• MC-36 Remote Cord/MC-36A Remote Cord (length 85 cm/2 ft 10 in.*)</li> <li>• MC-21 Extension Cord/MC-21A Extension Cord (length 3 m/9 ft 11 in.*)</li> <li>• MC-23 Connecting Cord/MC-23A Connecting Cord (length 40 cm/1 ft 4 in.*)</li> <li>• MC-25 Adapter Cord/MC-25A Adapter Cord (length 20 cm/8 in.*)</li> <li>• WR-A10 WR Adapter</li> <li>• GP-1 GPS Unit/GP-1A GPS Unit (□ 221)</li> <li>• ML-3 Modulite Remote Control Set</li> </ul> <p>* All values are approximate.</p>
<b>Microphones (□ 67)</b>	<ul style="list-style-type: none"> <li>• ME-1 Stereo Microphone</li> <li>• ME-W1 Wireless Microphone</li> </ul>
<b>Connector covers</b>	UF-4 USB Connector Cover

Availability may vary with country or region. See our website or brochures for the latest information.

### **Attaching and Removing the Accessory Shoe Cover**

The accessory shoe cover (available separately) slides into the accessory shoe as shown.

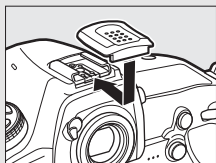

To remove the cover, hold the camera firmly, press the cover down with a thumb and slide it in the direction shown.

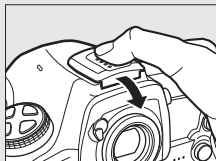

### **Attaching and Removing the Supplied Eyepiece**

After closing the eyepiece shutter and releasing the latch (①), lightly grasp the supplied DK-17F eyepiece in two fingers and rotate and remove as shown (②). To reattach, rotate the eyepiece in the opposite direction. Optional eyepieces can be attached and removed in the same fashion.

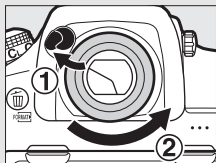

## Optional MB-D18 Battery Packs

The MB-D18 takes one EN-EL15a or EN-EL18b rechargeable battery or eight AA batteries (alkaline, Ni-MH, or lithium) and features controls for taking pictures in “tall” (portrait) orientation: shutter-release, **AF-ON**, and **Fn** buttons, a multi selector, and main and sub-command dials.

### Parts of the MB-D18

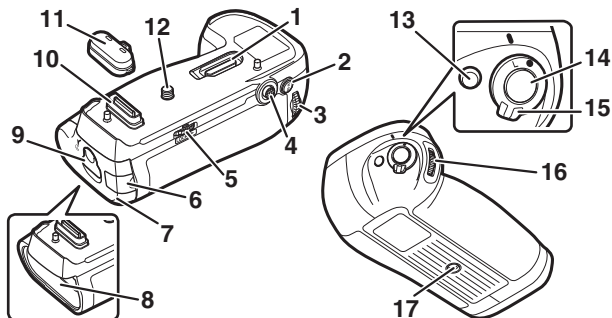

1	Contact cover holder .....	302	9	Battery-chamber latch .....	304
2	<b>AF-ON</b> button .....	301	10	Power/signal contacts .....	302
3	Main command dial .....	301	11	Contact cap .....	302
4	Multi selector .....	301	12	Mounting screw .....	302
5	Attachment wheel.....	302	13	<b>Fn</b> button .....	301
6	Holder power connector cover .....	307	14	Shutter-release button.....	301
7	Battery-chamber cover .....	304	15	Control lock.....	301
8	Battery chamber .....	304	16	Sub-command dial .....	301
			17	Tripod socket	

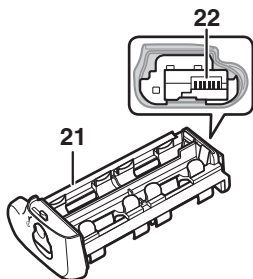
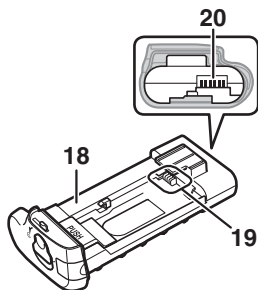

<b>18</b>	MS-D12EN holder for EN-EL15a batteries* ..... 304	<b>21</b>	MS-D12 holder for AA batteries..... 304
<b>19</b>	Power terminals ..... 304	<b>22</b>	Power terminals (MS-D12 battery holder) ..... 304
<b>20</b>	Power terminals (MS-D12EN battery holder) .... 304		

\* The MS-D12EN is inserted in the MB-D18 at shipment.

### Using an AC Adapter and Power Connector

The optional EH-5c/EH-5b AC adapter and EP-5B power connector can be used with the MB-D18 to provide a reliable power source when the camera is used for extended periods (☞ 307). Insert the EP-5B power connector in the MS-D12EN battery holder and connect the AC adapter. For more information, see the *Menu Guide* available on Nikon websites (☞ i).

## ■ ■ The Shutter-Release Button, Multi Selector, and Command Dials

These controls perform the same functions as the matching controls on the camera body, with the exception that, regardless of the option chosen for Custom Setting f5 (**Multi selector**, [□ 269](#)), the MB-D18 multi selector cannot be used to start the standby timer.

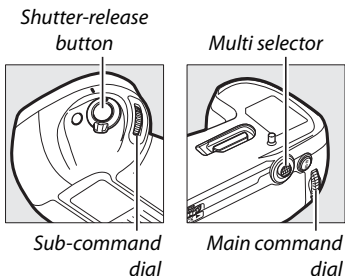

## ■ ■ The Fn and AF-ON Buttons

The functions performed by these controls can be selected using Custom Setting f10 (**Assign MB-D18 buttons**, [□ 270](#)).

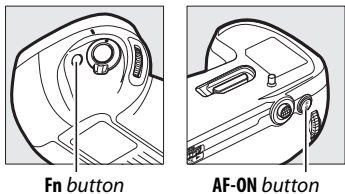

## ■ ■ The MB-D18 Control Lock

The control lock locks the controls on the MB-D18 to prevent unintended use. Before using these controls to take photographs in “tall” (portrait) orientation, release the lock as shown. The control lock is not a power switch. Use the camera power switch to turn the camera on and off.

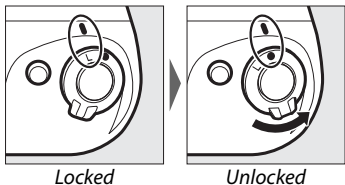

## Using the Battery Pack

### ■ Attaching the Battery Pack

Before attaching the battery pack, be sure that the camera is off and that the MB-D18 control lock is in the L position.

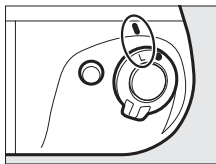

- 1 Remove the contact cap from the battery pack.

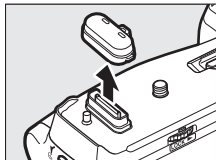

- 2 The contacts for the MB-D18 are in the base of the camera, where they are protected by a contact cover. Remove the contact cover (1) and place it in the contact cover holder on the MB-D18 (2).

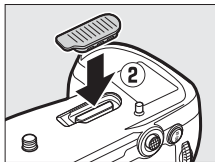
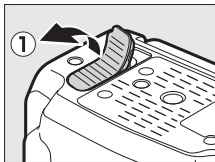

- 3** Position the MB-D18, keeping the MB-D18 mounting screw (②) aligned with the camera tripod socket (①), and tighten the attachment wheel by rotating it in the direction shown by the **LOCK** arrow.

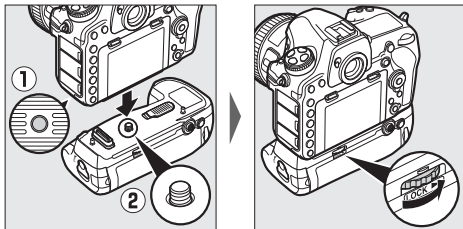

There is no need to remove the battery from the camera before connecting the MB-D18. At default settings, the battery inserted in the camera will be used only after the battery in the MB-D18 is exhausted. The **Battery order** option in the camera setup menu can be used to change the order in which the batteries are used.

**✓ Attaching the Battery Pack**

Be sure to place the camera contact cover in the contact cover holder and to keep the MB-D18 contact cap in a safe place to prevent loss. A PB-6D bellows spacer and PK-13 auto extension ring are required when using PB-6 bellows focusing attachment with the MB-D18.

## ■ ■ *Removing the Battery Pack*

To remove the MB-D18, turn the camera off and set the control lock on the MB-D18 to **L**, then loosen the attachment wheel by rotating it in the direction opposite to that shown by the **LOCK** arrow and remove the MB-D18.

## ■ ■ *Inserting Batteries*

The MB-D18 can be used with one EN-EL15a or EN-EL18b rechargeable battery or with eight AA batteries. Before inserting batteries, be sure that the camera is off and that the MB-D18 control lock is in the **L** position.

- 
- 1** Unlatch the MB-D18 by rotating the battery-chamber latch to **Ⓒ** and remove the battery holder.

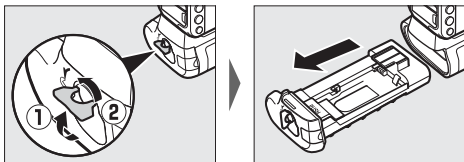



## 2 Ready the batteries as described below.

**EN-EL15a:** Matching the indentations on the battery to the projections on the MS-D12EN holder, insert the battery with the arrow (▲) on the battery toward the battery holder power terminals (①). Press the battery lightly downward and slide it in the direction of the arrow until the power terminals click into place (②).

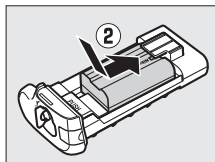
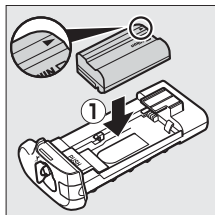

**EN-EL18b:** If the battery release on the optional BL-5 battery-chamber cover is positioned so that the arrow < is visible, slide the battery release to cover the arrow (①). Insert the two projections on the battery into the matching slots on the BL-5 (②) and confirm that the battery release has slid aside to reveal the arrow (③).

*Battery release*

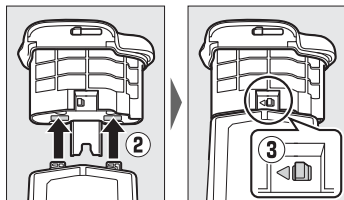
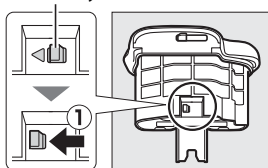

**AA batteries:** Place eight AA batteries in the MS-D12 battery holder as shown, making sure that the batteries are in the correct orientation.

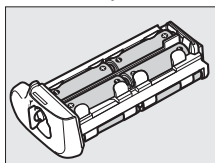
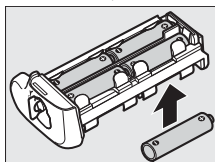
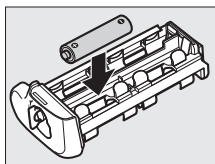

- 3** Insert the battery holder or EN-EL18b in the MB-D18 and latch the battery-chamber cover. Make sure the holder or battery is inserted before turning the latch; power will only be supplied if the cover is securely latched.

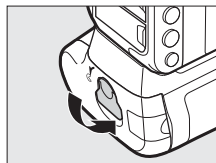
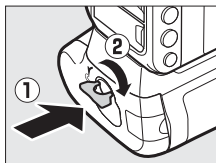

- 4** Turn the camera on and check the battery level in the control panel or viewfinder (☞ 30). If the camera does not turn on, check that the battery is correctly inserted. Match the option selected for **MB-D18 battery type** in the setup menu to the type of battery inserted in the battery pack (☞ 276). Information about the batteries can be displayed by selecting **Battery info** in the setup menu (☞ 276).

#### The EP-5B Power Connector

When using the EP-5B power connector, insert it into the MS-D12EN holder with the arrow (▲) on the connector toward the battery holder power terminals (①). Press the connector lightly downward and slide it in the direction of the arrow until the power terminals click into place (②). Open the holder power connector cover and pass the EP-5B power cable through the opening (③).

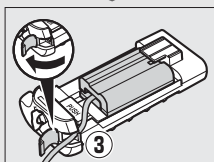
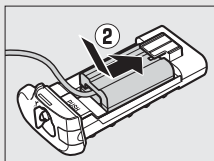
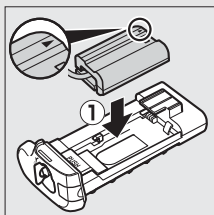

## ■ Removing Batteries

Be careful not to drop batteries or the holder.

- 1** Unlatch the MB-D18 by rotating the battery-chamber latch to  and remove the battery or battery holder.

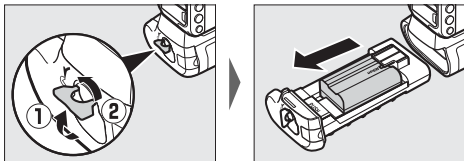

- 2** Remove the battery or batteries from the holder or BL-5 battery-chamber cover.

**EN-EL15a:** While pressing the holder **PUSH** button, slide the battery toward the button. The battery can then be removed as shown.

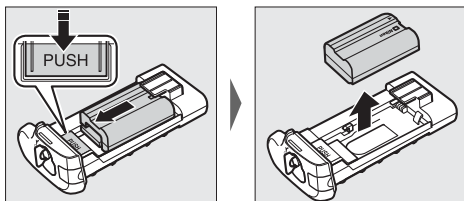

The procedure for removing the EP-5B power connector is the same as that for the EN-EL15a.

**EN-EL18b:** Slide the battery release in the direction indicated by the arrow (◁) and remove the BL-5.

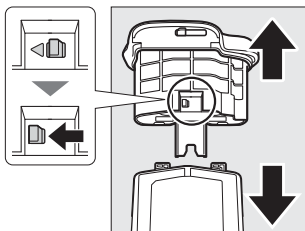

**AA batteries:** Remove the batteries as shown. Be careful not to drop the batteries when removing them from the holder.

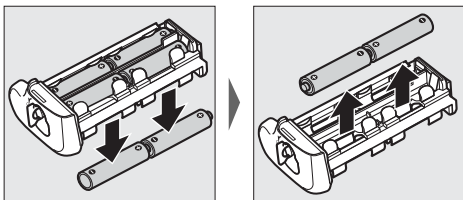

## Specifications

<b>Power source</b>	One EN-EL15a or EN-EL18b rechargeable Li-ion battery, eight alkaline (1.5 V) or lithium (1.5 V) AA batteries, eight Ni-MH (1.2 V) rechargeable AA batteries, or an EH-5c/EH-5b AC adapter (requires EP-5B power connector); EN-EL15, EN-EL18, and EN-EL18a batteries are also supported, but note that fewer pictures can be taken on a single charge with an EN-EL15 than with an EN-EL15a, and that fewer pictures can be taken on a single charge with an EN-EL18 than with an EN-EL18b/EN-EL18a (□ 365), and that EN-EL18b, EN-EL18a, and EN-EL18 batteries require an MH-26a or MH-26 battery charger and BL-5 battery-chamber cover (both available separately)
<b>Operating temperature</b>	0 °C–40 °C (+32 °F–104 °F)
<b>Dimensions (W × H × D)</b>	Approx. 152 × 51 × 79 mm (6.0 × 2.1 × 3.2 in.)
<b>Weight (approx.)</b>	<ul style="list-style-type: none"><li>• 355 g (12.6 oz) with MS-D12EN and optional EN-EL15a battery</li><li>• 450 g (15.9 oz) with MS-D12 and eight AA batteries (available separately from third-party suppliers)</li><li>• 305 g (10.8 oz) with MS-D12EN and optional EP-5B power connector</li><li>• 435 g (15.4 oz) with optional BL-5 and EN-EL18b battery</li><li>• 280 g (9.9 oz) with MS-D12EN</li><li>• 265 g (9.4 oz) with MS-D12</li></ul>

Nikon reserves the right to change the appearance and specifications of the hardware and software described in this manual at any time and without prior notice. Nikon will not be held liable for damages that may result from any mistakes that this manual may contain.

## Caring for the Camera

### Storage

When the camera will not be used for an extended period, remove the battery and store it in a cool, dry area with the terminal cover in place. To prevent mold or mildew, store the camera in a dry, well-ventilated area. Do not store your camera with naphtha or camphor moth balls or in locations that:

- are poorly ventilated or subject to humidities of over 60%
- are next to equipment that produces strong electromagnetic fields, such as televisions or radios
- are exposed to temperatures above 50 °C (122 °F) or below -10 °C (14 °F)

### Cleaning

<b>Camera body</b>	Use a blower to remove dust and lint, then wipe gently with a soft, dry cloth. After using the camera at the beach or seaside, wipe off sand or salt with a cloth lightly dampened in distilled water and dry thoroughly. <b>Important:</b> <i>Dust or other foreign matter inside the camera may cause damage not covered under warranty.</i>
<b>Lens, mirror, and viewfinder</b>	These glass elements are easily damaged. Remove dust and lint with a blower. If using an aerosol blower, keep the can vertical to prevent the discharge of liquid. To remove fingerprints and other stains, apply a small amount of lens cleaner to a soft cloth and clean with care.
<b>Monitor</b>	Remove dust and lint with a blower. When removing fingerprints and other stains, wipe the surface lightly with a soft cloth or chamois leather. Do not apply pressure, as this could result in damage or malfunction.

*Do not use alcohol, thinner, or other volatile chemicals.*

## **Image Sensor Cleaning**

If you suspect that dirt or dust on the image sensor is appearing in photographs, you can clean the sensor using the **Clean image sensor** option in the setup menu. The sensor can be cleaned at any time using the **Clean now** option, or cleaning can be performed automatically when the camera is turned on or off.

### **■ “Clean Now”**

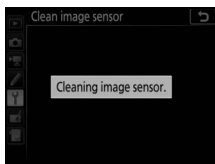
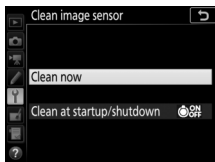
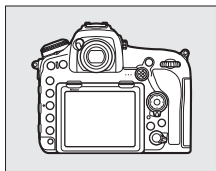

Holding the camera base down, select **Clean image sensor** in the setup menu, then highlight **Clean now** and press **OK**. The camera will check the image sensor and then begin cleaning. **b u S Y** flashes in the control panel and other operations cannot be performed while cleaning is in progress. Do not remove or disconnect the power source until cleaning ends and the setup menu is displayed.





## ■ ■ “Clean at Startup/Shutdown”

Choose from the following options:

Option	Description
 <b>Clean at startup</b>	The image sensor is automatically cleaned each time the camera is turned on.
 <b>Clean at shutdown</b>	The image sensor is automatically cleaned during shutdown each time the camera is turned off.
 <b>Clean at startup &amp; shutdown</b>	The image sensor is cleaned automatically at startup and at shutdown.
<b>Cleaning off</b>	Automatic image sensor cleaning off.

### 1 Select **Clean at startup/shutdown**.

Display the **Clean image sensor** menu as described in “Clean Now” (📖 312). Highlight **Clean at startup/shutdown** and press .

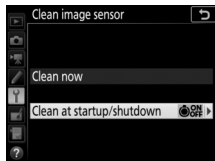

### 2 Select an option.

Highlight an option and press .

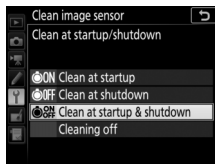

### ✔ Image Sensor Cleaning

Using camera controls during startup interrupts image sensor cleaning.

If dust cannot be fully removed using the options in the **Clean image sensor** menu, clean the image sensor manually (☞ 315) or consult a Nikon-authorized service representative.

If image sensor cleaning is performed several times in succession, image sensor cleaning may be temporarily disabled to protect the camera's internal circuitry. Cleaning can be performed again after a short wait.

## Manual Cleaning

If foreign matter cannot be removed from the image sensor using the **Clean image sensor** (☞ 312) option in the setup menu, the sensor can be cleaned manually as described below. Note, however, that the sensor is extremely delicate and easily damaged; we recommend that manual cleaning be performed only by a Nikon-authorized service representative.

---

### 1 Charge the battery or connect an AC adapter.

A reliable power source is required when inspecting or cleaning the image sensor. Turn the camera off and insert a fully-charged battery or connect an optional AC adapter and power connector. The **Lock mirror up for cleaning** option is only available in the setup menu if the battery level is over  and the camera is not connected to a smart device via Bluetooth or other devices via USB.

---

### 2 Remove the lens.

Turn the camera off and remove the lens.

---

### 3 Select **Lock mirror up for cleaning**.

Turn the camera on and highlight **Lock mirror up for cleaning** in the setup menu and press .

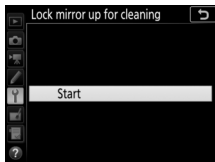

#### 4 Press .

A message will be displayed in the monitor and a row of dashes will appear in the control panel and viewfinder. To restore normal operation without inspecting the image sensor, turn the camera off.

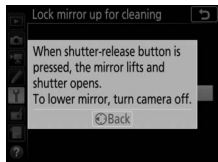

#### 5 Raise the mirror.

Press the shutter-release button all the way down. The mirror will be raised

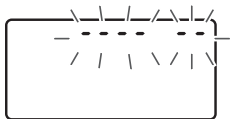

and the shutter curtain will open, revealing the image sensor. The display in the viewfinder will turn off and the row of dashes in the control panel will flash.

#### 6 Examine the image sensor.

Holding the camera so that light falls on the image sensor, examine the sensor for dust or lint. If no foreign objects are present, proceed to Step 8.

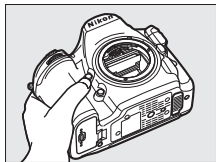

---

## 7 Clean the sensor.

Remove any dust and lint from the sensor with a blower. Do not use a blower-brush, as the bristles could damage the sensor. Dirt that cannot be removed with a blower can only be removed by Nikon-authorized service personnel. Under no circumstances should you touch or wipe the sensor.



---

## 8 Turn the camera off.

The mirror will return to the down position and the shutter curtain will close. Replace the lens or body cap.

### Use a Reliable Power Source

The shutter curtain is delicate and easily damaged. If the camera powers off while the mirror is raised, the curtain will close automatically. To prevent damage to the curtain, observe the following precautions:

- Do not turn the camera off or remove or disconnect the power source while the mirror is raised.
- If the battery runs low while the mirror is raised, a beep will sound and the self-timer lamp will flash to warn that the shutter curtain will close and the mirror will be lowered after about two minutes. End cleaning or inspection immediately.

### **✔ Foreign Matter on the Image Sensor**

Foreign matter entering the camera when lenses or body caps are removed or exchanged (or in rare circumstances lubricant or fine particles from the camera itself) may adhere to the image sensor, where it may appear in photographs taken under certain conditions. To protect the camera when no lens is in place, be sure to replace the body cap provided with the camera, being careful to first remove all dust and other foreign matter that may be adhering to the camera mount, lens mount, and body cap. Avoid attaching the body cap or exchanging lenses in dusty environments.

Should foreign matter find its way onto the image sensor, use the image sensor cleaning option as described in “Image Sensor Cleaning” (☐ 312). If the problem persists, clean the sensor manually (☐ 315) or have the sensor cleaned by authorized Nikon service personnel. Photographs affected by the presence of foreign matter on the sensor can be retouched using the clean image options available in some imaging applications.

### **✔ Servicing the Camera and Accessories**

The camera is a precision device and requires regular servicing. Nikon recommends that the camera be inspected by the original retailer or a Nikon-authorized service representative once every one to two years, and that it be serviced once every three to five years (note that fees apply to these services). Frequent inspection and servicing are particularly recommended if the camera is used professionally. Any accessories regularly used with the camera, such as lenses or optional flash units, should be included when the camera is inspected or serviced.

## Caring for the Camera and Battery: Cautions

**Do not drop:** The product may malfunction if subjected to strong shocks or vibration.

**Keep dry:** This product is not waterproof, and may malfunction if immersed in water or exposed to high levels of humidity. Rusting of the internal mechanism can cause irreparable damage.

**Avoid sudden changes in temperature:** Sudden changes in temperature, such as those that occur when entering or leaving a heated building on a cold day, can cause condensation inside the device. To prevent condensation, place the device in a carrying case or plastic bag before exposing it to sudden changes in temperature.

**Keep away from strong magnetic fields:** Do not use or store this device in the vicinity of equipment that generates strong electromagnetic radiation or magnetic fields. Static charges or the magnetic fields produced by equipment such as radio transmitters could interfere with the monitor, damage data stored on the memory card, or affect the product's internal circuitry.

**Do not leave the lens pointed at the sun:** Do not leave the lens pointed at the sun or other strong light source for an extended period. Intense light may cause the image sensor to deteriorate or produce a white blur effect in photographs.

**Turn the product off before removing or disconnecting the power source:** Do not unplug the product or remove the battery while the product is on or while images are being recorded or deleted. Forcibly cutting power in these circumstances could result in loss of data or in damage to product memory or internal circuitry. To prevent an accidental interruption of power, avoid carrying the product from one location to another while the AC adapter is connected.

**Cleaning:** When cleaning the camera body, use a blower to gently remove dust and lint, then wipe gently with a soft, dry cloth. After using the camera at the beach or seaside, wipe off any sand or salt using a cloth lightly dampened in pure water and then dry the camera thoroughly. In rare instances, static electricity may cause the LCD displays to light up or go dark. This does not indicate a malfunction, and the display will soon return to normal.

The lens and mirror are easily damaged. Dust and lint should be gently removed with a blower. When using an aerosol blower, keep the can vertical to prevent discharge of liquid. To remove fingerprints and other stains from the lens, apply a small amount of lens cleaner to a soft cloth and wipe the lens carefully.

See “Image Sensor Cleaning” (📖 312) for information on cleaning the image sensor.

**Lens contacts:** Keep the lens contacts clean.

**Do not touch the shutter curtain:** The shutter curtain is extremely thin and easily damaged. Under no circumstances should you exert pressure on the curtain, poke it with cleaning tools, or subject it to powerful air currents from a blower. These actions could scratch, deform, or tear the curtain.

The shutter curtain may appear to be unevenly colored, but this has no affect on pictures and does not indicate a malfunction.



**Storage:** To prevent mold or mildew, store the camera in a dry, well-ventilated area. If you are using an AC adapter, unplug the adapter to prevent fire. If the product will not be used for an extended period, remove the battery to prevent leakage and store the camera in a plastic bag containing a desiccant. Do not, however, store the camera case in a plastic bag, as this may cause the material to deteriorate. Note that desiccant gradually loses its capacity to absorb moisture and should be replaced at regular intervals.

To prevent mold or mildew, take the camera out of storage at least once a month. Turn the camera on and release the shutter a few times before putting it away.

Store the battery in a cool, dry place. Replace the terminal cover before putting the battery away.

**Notes on the monitor:** The monitor is constructed with extremely high precision; at least 99.99% of pixels are effective, with no more than 0.01% being missing or defective. Hence while these displays may contain pixels that are always lit (white, red, blue, or green) or always off (black), this is not a malfunction and has no effect on images recorded with the device.

Images in the monitor may be difficult to see in a bright light.

Do not apply pressure to the monitor, as this could cause damage or malfunction. Dust or lint on the monitor can be removed with a blower. Stains can be removed by wiping lightly with a soft cloth or chamois leather. Should the monitor break, care should be taken to avoid injury from broken glass and to prevent liquid crystal from the monitor touching the skin or entering the eyes and mouth.



**The battery and charger:** Batteries may leak or explode if improperly handled. Observe the following precautions when handling batteries and chargers:

- Use only batteries approved for use in this equipment.
- Do not expose the battery to flame or excessive heat.
- Keep the battery terminals clean.
- Turn the product off before replacing the battery.
- Remove the battery from the camera or charger when not in use and replace the terminal cover. These devices draw minute amounts of charge even when off and could draw the battery down to the point that it will no longer function. If the battery will not be used for some time, insert it in the camera and run it flat before removing it from the camera for storage. The battery should be stored in a cool location with an ambient temperature of 15 °C to 25 °C (59 °F to 77 °F; avoid hot or extremely cold locations). Repeat this process at least once every six months.
- Turning the camera on or off repeatedly when the battery is fully discharged will shorten battery life. Batteries that have been fully discharged must be charged before use.
- The internal temperature of the battery may rise while the battery is in use. Attempting to charge the battery while the internal temperature is elevated will impair battery performance, and the battery may not charge or charge only partially. Wait for the battery to cool before charging.
- Charge the battery indoors at ambient temperatures of 5 °C–35 °C (41 °F–95 °F). Do not use the battery at ambient temperatures below 0 °C (32 °F) or above 40 °C (104 °F); failure to observe this precaution could damage the battery or impair its performance. Capacity may be reduced and charging times increase at battery temperatures from 0 °C (32 °F) to 15 °C (59 °F) and from 45 °C (113 °F) to 60 °C (140 °F). The battery will not charge if its temperature is below 0 °C (32 °F) or above 60 °C (140 °F).

- If the **CHARGE** lamp flashes quickly (about eight times a second) during charging, confirm that the temperature is in the correct range and then unplug the charger and remove and reinsert the battery. If the problem persists, cease use immediately and take battery and charger to your retailer or a Nikon-authorized service representative.
- Do not move the charger or touch the battery during charging. Failure to observe this precaution could in very rare instances result in the charger showing that charging is complete when the battery is only partially charged. Remove and reinsert the battery to begin charging again.
- Battery capacity may temporarily drop if the battery is charged at low temperatures or used at a temperature below the temperature at which it was charged. If the battery is charged at a temperature below 5 °C (41 °F), the battery life indicator in the **Battery info** (□ 276) display may show a temporary decrease.
- Continuing to charge the battery after it is fully charged can impair battery performance.
- A marked drop in the time a fully charged battery retains its charge when used at room temperature indicates that it requires replacement. Purchase a new EN-EL15a battery.
- The supplied power cable and AC wall adapter are for use with the MH-25a only. Use the charger with compatible batteries only. Unplug when not in use.
- Do not short the charger terminals. Failure to observe this precaution could result in overheating and damage to the charger.
- Charge the battery before use. When taking photographs on important occasions, ready a spare battery and keep it fully charged. Depending on your location, it may be difficult to purchase replacement batteries on short notice. Note that on cold days, the capacity of batteries tends to decrease. Be sure the battery is fully charged before taking photographs outside in cold weather. Keep a spare battery in a warm place and exchange the two as necessary. Once warmed, a cold battery may recover some of its charge.
- Used batteries are a valuable resource; recycle in accord with local regulations.

## Troubleshooting

If the camera fails to function as expected, check the list of common problems below before consulting your retailer or Nikon-authorized service representative.

### **Battery/Display**

---

**The camera is on but does not respond:** Wait for recording to end. If the problem persists, turn the camera off. If the camera does not turn off, remove and reinsert the battery or, if you are using an AC adapter, disconnect and reconnect the AC adapter. Note that although any data currently being recorded will be lost, data that have already been recorded will not be affected by removing or disconnecting the power source.

---

**Viewfinder is out of focus:** Adjust viewfinder focus (☐ 9). If this does not correct the problem, select single-servo AF (**AF-S**; ☐ 98), single-point AF (☐ 100), and the center focus point (☐ 105), and then frame a high-contrast subject in the center focus point and press the shutter-release button halfway to focus the camera. With the camera in focus, use the diopter adjustment control to bring the subject into clear focus in the viewfinder. If necessary, viewfinder focus can be further adjusted using optional corrective lenses (☐ 296).

---

**Viewfinder is dark:** Insert a fully-charged battery (☐ 14, 30).

---

**Displays turn off without warning:** Choose longer delays for Custom Setting c2 (**Standby timer**; ☐ 263) or c4 (**Monitor off delay**; ☐ 264).

---

**Displays in control panel or viewfinder are unresponsive and dim:** The response times and brightness of these displays vary with temperature.

---

**The viewfinder display turns red when a focus point is highlighted:** This is normal for this type of viewfinder and does not indicate a malfunction.

---







## Shooting

---

**Camera takes time to turn on:** Delete files or folders.

---

**Shutter-release disabled:**

- Memory card is locked (SD cards only;  17), full, or not inserted ( 31).
  - **Release locked** is selected for **Slot empty release lock** in the setup menu ( 276) and no memory card is inserted ( 16).
  - Aperture ring for CPU lens not locked at highest f-number (does not apply to type G and E lenses). If **F $\bar{E}$  E** is displayed in the control panel, select **Aperture ring** for Custom Setting f4 (**Customize command dials**) > **Aperture setting** to use lens aperture ring to adjust aperture ( 269).
  - Exposure mode **S** selected with **b $\bar{u}$  L b** or **- -** selected for shutter speed ( 129, 133).
- 



**Camera is slow to respond to shutter-release button:** Select **Off** for Custom Setting d5 (**Exposure delay mode**;  264).

---



**Only one shot taken each time shutter-release button is pressed in continuous release mode:** Turn HDR off ( 182).

---

**Photos are out of focus:**

- Rotate focus-mode selector to **AF** ( 94).
  - Camera unable to focus using autofocus: use manual focus or focus lock ( 108, 111).
- 

**Beep does not sound:**

- **Off** is selected for **Beep options** > **Beep on/off** in setup menu ( 274).
  - **AF-C** is selected for AF mode ( 98).
- 

**Full range of shutter speeds not available:** Flash in use. Flash sync speed can be selected using Custom Setting e1 (**Flash sync speed**); when using compatible flash units, choose **1/250 s (Auto FP)** for full range of shutter speeds ( 266).

---

**Focus does not lock when shutter-release button is pressed halfway:** Camera is in focus mode **AF-C**: use the center of the sub-selector to lock focus ( 108).

---

---

**Cannot select focus point:**

- Unlock focus selector lock (☐ 105).
- Auto-area AF selected, or face-priority AF selected in live view; choose another mode (☐ 42, 100).
- Camera is in playback mode (☐ 223) or menus are in use (☐ 248).
- Press shutter-release button halfway to start standby timer (☐ 34).

---

**Cannot select AF mode:** Select **No restrictions** for Custom Setting a10 (**Autofocus mode restrictions**, ☐ 262).

---

**Camera is slow to record photos:** Turn long exposure noise reduction off (☐ 253).

---

**Noise (bright spots, randomly-spaced bright pixels, fog, or lines) appear in photos:**

- Bright spots, randomly-spaced bright pixels, fog, and lines can be reduced by lowering ISO sensitivity.
- Use the **Long exposure NR** option in the photo shooting menu to limit the occurrence of bright spots or fog in photos taken at shutter speeds slower than 1 s (☐ 253).
- Fog and bright spots may indicate that the camera's internal temperature has become elevated due to high ambient temperatures, long exposures, or similar causes: turn the camera off and wait for it to cool before resuming shooting.
- At high ISO sensitivities, lines may appear in photos taken with some optional flash units; if this occurs, choose a lower value.
- At high ISO sensitivities, including high values selected with auto ISO sensitivity control, randomly-spaced bright pixels can be reduced by selecting **High, Normal, or Low** for **High ISO NR** in the photo or movie shooting menu (☐ 253, 258).
- At high ISO sensitivities, bright spots, randomly-spaced bright pixels, fog, or lines may be more noticeable in long exposures, multiple exposures, and photos taken at high ambient temperatures or with Active D-Lighting enabled, **Flat** selected for **Set Picture Control** (☐ 175) or extreme values selected for Picture Control parameters (☐ 178).

---

**Photographs and movies do not appear to have the same exposure as the preview shown in the monitor during live view:** Changes to monitor brightness during live view have no effect on images recorded with the camera (☐ 45).

---

**Flicker or banding appears in movie mode:** Select **Flicker reduction** in the movie shooting menu and choose an option that matches the frequency of the local AC power supply (☐ 258).

---

**Bright regions or bands appear in live view:** A flashing sign, flash, or other light source with brief duration was used during live view.

---

**Smudges appear in photographs:** Clean front and rear lens elements. If problem persists, perform image sensor cleaning (☐ 312).

---

**Live view ends unexpectedly or does not start:** Live view may end automatically to prevent damage to the camera's internal circuits if:

- The ambient temperature is high
- The camera has been used for extended periods in live view or to record movies
- The camera has been used in continuous release modes for extended periods

If live view does not start when you press the  button, wait for the internal circuits to cool and then try again. Note that the camera may feel warm to the touch, but this does not indicate a malfunction.

---

**Image artifacts appear during live view:** "Noise" (randomly-spaced bright pixels, fog, or lines) and unexpected colors may appear if you zoom in on the view through the lens (☐ 40) during live view; in movies, the amount and distribution of randomly-spaced bright pixels, fog, and bright spots are affected by frame size and rate (☐ 69). Randomly-spaced bright pixels, fog, or bright spots may also arise as a result of increases in the temperature of the camera's internal circuits during live view; exit live view when the camera is not in use.

---

**Cannot measure white balance:** Subject is too dark or too bright (☐ 166).

---

**Image cannot be selected as source for preset white balance:** Image was not created with D850 (☐ 172).

---

**White balance bracketing unavailable:**

- NEF (RAW) or NEF+JPEG image quality option selected for image quality (☐ 88).
  - Multiple exposure mode is in effect (☐ 254).
-

---

**Effects of Picture Control differ from image to image:** **Auto** is selected for **Set Picture Control**, a Picture Control based on **Auto** is selected, or **A** (auto) is selected for sharpening, clarity, contrast, or saturation. For consistent results over a series of photographs, choose another setting (☐ 177).

---

**Metering cannot be changed:** Autoexposure lock is in effect (☐ 138).

---

**Exposure compensation cannot be used:** Choose exposure mode **P**, **S**, or **A** (☐ 126, 139).

---

**Noise (reddish areas or other artifacts) appears in long time-exposures:** Enable long exposure noise reduction (☐ 253).

---

**Sound is not recorded with movies:** **Microphone off** is selected for **Microphone sensitivity** in the movie shooting menu (☐ 258).

---

## Playback

---

**NEF (RAW) image is not played back:** Photo was taken at image quality of NEF + JPEG (☐ 89).

---

**Cannot view pictures recorded with other cameras:** Pictures recorded with other makes of camera may not be displayed correctly.

---

**Some photos are not displayed during playback:** Select **All** for **Playback folder** (☐ 248).

---

**“Tall” (portrait) orientation photos are displayed in “wide” (landscape) orientation:**

- Photo was taken with **Off** selected for **Auto image rotation** (☐ 249).
- Select **On** for **Rotate tall** (☐ 249).
- Photo is displayed in image review (☐ 249).
- Camera was pointed up or down when photo was taken.

---

**Cannot delete photo:** Picture is protected. Remove protection (☐ 240).

---

**Cannot retouch picture:** Photo cannot be further edited with this camera.

---

**The camera displays a message stating that the folder contains no images:** Select **All** for **Playback folder** (☐ 248).

---

**Cannot print photos:** NEF (RAW) and TIFF photos cannot be printed by direct USB connection. Transfer photos to computer and print using Capture NX-D (☐ ii). NEF (RAW) photos can be saved in JPEG format using **NEF (RAW) processing** (☐ 278).

---



---

**Photo is not displayed on high-definition video device:** Confirm that HDMI cable (available separately) is connected.

---

**Image Dust Off option in Capture NX-D does not have desired effect:** Image sensor cleaning changes the position of dust on the image sensor. Dust off reference data recorded before image sensor cleaning is performed cannot be used with photographs taken after image sensor cleaning is performed. Dust off reference data recorded after image sensor cleaning is performed cannot be used with photographs taken before image sensor cleaning is performed.

---

**Computer displays NEF (RAW) images differently from camera:** Third-party software does not display effects of Picture Controls, Active D-Lighting, or vignette control. Use Capture NX-D (□ ii).

---

**Cannot transfer photos to computer:** OS not compatible with camera or transfer software. Use card reader to copy photos to computer.

---

## **Bluetooth and Wi-Fi (Wireless Networks)**

---

**Smart devices do not display the camera SSID (network name):**

- Confirm that **Disable** is selected for **Airplane mode** in the camera setup menu (□ 275).
  - Confirm that **Enable** is selected for **Bluetooth > Network connection** in the camera setup menu.
  - Try turning the smart device Wi-Fi off and then on again.
- 

**Cannot connect to wireless printers and other wireless devices:** This camera can connect only to devices to which the SnapBridge app has been installed.

---

## **Miscellaneous**

---

**Date of recording is not correct:** The camera clock is less accurate than most watches and household clocks. Check the clock regularly against more accurate timepieces and reset as necessary.







---

**Menu item cannot be selected:** Some options are not available at certain combinations of settings or when no memory card is inserted. Note that **Battery info** option is not available when camera is powered by an optional power connector and AC adapter.









---

## Error Messages

This section lists the indicators and error messages that appear in the viewfinder, control panel, and monitor.

Indicator		Problem	Solution
Control panel	View-finder		
<b>fE E</b> (flashes)		Lens aperture ring is not set to minimum aperture.	Set ring to minimum aperture (highest f-number;  127).
		Low battery.	Ready a fully-charged spare battery (  14, 30).
 (flashes)	 (flashes)	<ul style="list-style-type: none"> <li>• Battery exhausted.</li> <li>• Battery cannot be used.</li> <li>• An extremely exhausted rechargeable Li-ion battery or a third-party battery is inserted either in the camera or in the optional MB-D18 multi-power battery pack.</li> <li>• High battery temperature.</li> </ul>	<ul style="list-style-type: none"> <li>• Recharge or replace battery ( 14, 30, 296).</li> <li>• Contact Nikon-authorized service representative.</li> <li>• Replace the battery, or recharge the battery if the rechargeable Li-ion battery is exhausted.</li> <li>• Remove battery and wait for it to cool.</li> </ul>

Indicator		Problem	Solution
Control panel	Viewfinder		
	$\Delta f$	No lens attached, or non-CPU lens attached without specifying maximum aperture. Aperture shown in stops from maximum aperture.	Aperture value will be displayed if maximum aperture is specified (□ 218).
—	▶ ◀ (flashes)	Camera unable to focus using autofocus.	Change composition or focus manually (□ 32, 111).
(Exposure indicators and shutter speed or aperture display flash)		Subject too bright; photo will be overexposed.	<ul style="list-style-type: none"> <li>• Use a lower ISO sensitivity (□ 119).</li> <li>• Use optional ND filter. In exposure mode:               <ul style="list-style-type: none"> <li><b>S</b> Increase shutter speed (□ 129)</li> <li><b>A</b> Choose a smaller aperture (higher f-number; □ 130)</li> </ul> </li> </ul>
		Subject too dark; photo will be underexposed.	<ul style="list-style-type: none"> <li>• Use a higher ISO sensitivity (□ 119).</li> <li>• Use optional flash (□ 187). In exposure mode:               <ul style="list-style-type: none"> <li><b>S</b> Lower shutter speed (□ 129)</li> <li><b>A</b> Choose a larger aperture (lower f-number; □ 130)</li> </ul> </li> </ul>

Indicator		Problem	Solution
Control panel	View-finder		
 (flashes)		 selected in exposure mode <b>S</b> .	Change shutter speed or select manual exposure mode (☐ 129, 131).
- - (flashes)		- - selected in exposure mode <b>S</b> .	Change shutter speed or select manual exposure mode (☐ 129, 131).
 (flashes)	 (flashes)	Processing in progress.	Wait until processing is complete.
—	 (flashes)	If indicator flashes for 3s after flash fires, photo may be underexposed.	Check photo in monitor; if underexposed, adjust settings and try again.
 (flashes)	—	Flash unit that does not support red-eye reduction attached and flash sync mode set to red-eye reduction.	Change flash sync mode or use flash unit that supports red-eye reduction (☐ 193, 288).
 (flashes)	 (flashes)	Memory insufficient to record further photos at current settings, or camera has run out of file or folder numbers.	<ul style="list-style-type: none"> <li>• Reduce quality or size (☐ 88, 91).</li> <li>• Delete photographs after copying important images to computer or other device (☐ 245).</li> <li>• Insert new memory card (☐ 16).</li> </ul>
 (flashes)		Camera malfunction.	Release shutter. If error persists or appears frequently, consult Nikon-authorized service representative.

Indicator		Problem	Solution
Monitor	Control panel		
<b>No memory card.</b>	(- E -)	Camera cannot detect memory card.	Turn camera off and confirm that card is correctly inserted (□ 16).
<b>Cannot access this memory card. Insert another card.</b>	Er d, (Err) (flashes)	<ul style="list-style-type: none"> <li>• Error accessing memory card.</li> <li>• Unable to create new folder.</li> </ul>	<ul style="list-style-type: none"> <li>• Use Nikon-approved card (□ 360).</li> <li>• If error persists after card has been repeatedly ejected and reinserted, card may be damaged. Contact retailer or Nikon-authorized service representative.</li> <li>• Delete files or insert new memory card after copying important images to computer or other device (□ 16, 245, 360).</li> </ul>
	Er d, Err (flashes)	Camera cannot control Eye-Fi card.	<ul style="list-style-type: none"> <li>• Check that Eye-Fi card firmware is up to date.</li> <li>• Copy files on Eye-Fi card to a computer or other device and format card, or insert new card.</li> </ul>
<b>Memory card is locked. Slide lock to “write” position.</b>	Er d, - - - (flashes)	Memory card is locked (write protected).	Slide card write-protect switch to “write” position (□ 17).
<b>Not available if Eye-Fi card is locked.</b>	Er d, Err (flashes)	Eye-Fi card is locked (write protected).	

Indicator		Problem	Solution
Monitor	Control panel		
<b>This card is not formatted. Format the card.</b>	[F  r] (flashes)	Memory card has not been formatted for use in camera.	Format memory card or insert new memory card (☞ 271, 360).
<b>Unable to start live view. Please wait.</b>	—	The internal temperature of the camera is high.	Wait for the internal circuits to cool before resuming live view photography or movie recording.
<b>Folder contains no images.</b>	—	No images on memory card or in folder(s) selected for playback.	Select folder containing images from <b>Playback folder</b> menu or insert memory card containing images (☞ 16, 248).
<b>All images are hidden.</b>	—	All photos in current folder are hidden.	No images can be played back until another folder has been selected or <b>Hide image</b> used to allow at least one image to be displayed (☞ 248).
<b>Cannot display this file.</b>	—	File has been created or modified using a computer or different make of camera, or file is corrupt.	File cannot be played back on camera.
<b>Cannot select this file.</b>	—	Selected image cannot be retouched.	Images created with other devices cannot be retouched.

Indicator		Problem	Solution
Monitor	Control panel		
<b>This movie cannot be edited.</b>	—	The selected movie cannot be edited.	<ul style="list-style-type: none"> <li>• Movies created with other devices cannot be edited.</li> <li>• Movies must be at least two seconds long (☐ 81).</li> </ul>
<b>Check printer.</b>	—	Printer error.	Check printer. To resume, select <b>Continue</b> (if available)*.
<b>Check paper.</b>	—	Paper in printer is not of selected size.	Insert paper of correct size and select <b>Continue</b> *.
<b>Paper jam.</b>	—	Paper is jammed in printer.	Clear jam and select <b>Continue</b> *.
<b>Out of paper.</b>	—	Printer is out of paper.	Insert paper of selected size and select <b>Continue</b> *.
<b>Check ink supply.</b>	—	Ink error.	Check ink. To resume, select <b>Continue</b> *.
<b>Out of ink.</b>	—	Printer is out of ink.	Replace ink and select <b>Continue</b> *.

\* See printer manual for more information.

# Specifications

## ■ Nikon D850 Digital Camera

<b>Type</b>	
Type	Single-lens reflex digital camera
Lens mount	Nikon F mount (with AF coupling and AF contacts)
Effective angle of view	Nikon FX format
<b>Effective pixels</b>	
Effective pixels	45.7 million
<b>Image sensor</b>	
Image sensor	35.9 × 23.9 mm CMOS sensor
Total pixels	46.89 million
Dust-reduction System	Image sensor cleaning, Image Dust Off reference data (Capture NX-D software required)
<b>Storage</b>	
Image size (pixels)	<ul style="list-style-type: none"><li>• <b>FX (36×24) image area</b> 8256 × 5504 (Large: 45.4 M) 6192 × 4128 (Medium: 25.6 M) 4128 × 2752 (Small: 11.4 M)</li><li>• <b>1.2× (30×20) image area</b> 6880 × 4584 (Large: 31.5 M) 5152 × 3432 (Medium: 17.7 M) 3440 × 2288 (Small: 7.9 M)</li><li>• <b>DX (24×16) image area</b> 5408 × 3600 (Large: 19.5 M) 4048 × 2696 (Medium: 10.9 M) 2704 × 1800 (Small: 4.9 M)</li><li>• <b>5 : 4 (30×24) image area</b> 6880 × 5504 (Large: 37.9 M) 5152 × 4120 (Medium: 21.2 M) 3440 × 2752 (Small: 9.5 M)</li></ul>



Storage	
<b>Image size (pixels)</b>	<ul style="list-style-type: none"> <li>• <b>1 : 1 (24×24) image area</b> 5504 × 5504 (Large: 30.3 M) 4128 × 4128 (Medium: 17.0 M) 2752 × 2752 (Small: 7.6 M)</li> <li>• <b>FX-format photographs taken during movie recording</b> 8256 × 4640 (Large) 6192 × 3480 (Medium) 4128 × 2320 (Small)</li> <li>• <b>DX-format photographs taken during movie recording</b> 5408 × 3040 (Large) 4048 × 2272 (Medium) 2704 × 1520 (Small)</li> </ul>
<b>File format</b>	<ul style="list-style-type: none"> <li>• <b>NEF (RAW):</b> 12 or 14 bit (lossless compressed, compressed, or uncompressed); large, medium, and small available (medium and small images are recorded at a bit depth of 12 bits using lossless compression)</li> <li>• <b>TIFF (RGB)</b></li> <li>• <b>JPEG:</b> JPEG-Baseline compliant with fine (approx. 1 : 4), normal (approx. 1 : 8), or basic (approx. 1 : 16) compression; optimal quality compression available</li> <li>• <b>NEF (RAW)+JPEG:</b> Single photograph recorded in both NEF (RAW) and JPEG formats</li> </ul>
<b>Picture Control System</b>	Auto, Standard, Neutral, Vivid, Monochrome, Portrait, Landscape, Flat; selected Picture Control can be modified; storage for custom Picture Controls
<b>Media</b>	XQD and SD (Secure Digital) and UHS-II compliant SDHC and SDXC memory cards
<b>Dual card slots</b>	Either card can be used for primary or backup storage or for separate storage of NEF (RAW) and JPEG images; pictures can be copied between cards.
<b>File system</b>	DCF 2.0, Exif 2.31, PictBridge

Viewfinder	
<b>Viewfinder</b>	Eye-level pentaprism single-lens reflex viewfinder
<b>Frame coverage</b>	<ul style="list-style-type: none"> <li>• <b>FX (36×24)</b>: Approx. 100% horizontal and 100% vertical</li> <li>• <b>1.2× (30×20)</b>: Approx. 97% horizontal and 97% vertical</li> <li>• <b>DX (24×16)</b>: Approx. 97% horizontal and 97% vertical</li> <li>• <b>5:4 (30×24)</b>: Approx. 97% horizontal and 100% vertical</li> <li>• <b>1:1 (24×24)</b>: Approx. 97% horizontal and 100% vertical</li> </ul>
<b>Magnification</b>	Approx. $0.75 \times$ (50 mm f/1.4 lens at infinity, $-1.0 \text{ m}^{-1}$ )
<b>Eyepoint</b>	17 mm ( $-1.0 \text{ m}^{-1}$ ; from center surface of viewfinder eyepiece lens)
<b>Diopter adjustment</b>	$-3$ – $+1 \text{ m}^{-1}$
<b>Focusing screen</b>	Type B BriteView Clear Matte Mark VIII screen with AF area brackets (framing grid can be displayed)
<b>Reflex mirror</b>	Quick return
<b>Depth-of-field preview</b>	Pressing <b>Pv</b> button stops lens aperture down to value selected by user ( <b>A</b> and <b>M</b> modes) or by camera ( <b>P</b> and <b>S</b> modes)
<b>Lens aperture</b>	Instant return, electronically controlled

Lens	
<b>Compatible lenses</b>	<p>Compatible with AF NIKKOR lenses, including type G, E, and D lenses (some restrictions apply to PC lenses), and DX lenses (using DX 24 × 16 image area), AI-P NIKKOR lenses, and non-CPU AI lenses (exposure modes <b>A</b> and <b>M</b> only). IX NIKKOR lenses, lenses for the F3AF, and non-AI lenses cannot be used.</p> <p>The electronic rangefinder can be used with lenses that have a maximum aperture of f/5.6 or faster (the electronic rangefinder supports 15 focus points with lenses that have a maximum aperture of f/8 or faster, of which 9 points are available for selection).</p>
Shutter	
<b>Type</b>	Electronically-controlled vertical-travel focal-plane mechanical shutter; electronic front-curtain shutter available in quiet shutter-release, quiet continuous shutter-release, and mirror up release modes
<b>Speed</b>	$\frac{1}{8000}$ – 30 s in steps of $\frac{1}{3}$ , $\frac{1}{2}$ , or 1 EV, bulb, time, X250
<b>Flash sync speed</b>	X = $\frac{1}{250}$ s; synchronizes with shutter at $\frac{1}{250}$ s or slower; Auto FP High-Speed sync supported
Release	
<b>Release mode</b>	<b>S</b> (single frame), <b>CL</b> (continuous low speed), <b>CH</b> (continuous high speed), <b>Q</b> (quiet shutter-release), <b>QC</b> (quiet continuous shutter-release), $\odot$ (self-timer), <b>MUP</b> (mirror up)

Release	
Approximate frame advance rate	<ul style="list-style-type: none"> <li>• <b>With an EN-EL18b battery inserted in an MB-D18 battery pack</b>  <b>C:</b> 1–8 fps  <b>CH:</b> 9 fps  <b>QC:</b> 3 fps</li> <li>• <b>Other power sources</b>  <b>C:</b> 1–6 fps  <b>CH:</b> 7 fps  <b>QC:</b> 3 fps</li> </ul>
Self-timer	2 s, 5 s, 10 s, 20 s; 1–9 exposures at intervals of 0.5, 1, 2, or 3 s
Exposure	
Metering system	TTL exposure metering using RGB sensor with approximately 180K (180,000) pixels
Metering mode	<ul style="list-style-type: none"> <li>• <b>Matrix:</b> 3D color matrix metering III (type G, E, and D lenses); color matrix metering III (other CPU lenses); color matrix metering available with non-CPU lenses if user provides lens data</li> <li>• <b>Center-weighted:</b> Weight of 75% given to 12 mm circle in center of frame. Diameter of circle can be changed to 8, 15, or 20 mm, or weighting can be based on average of entire frame (non-CPU and AF-S Fisheye NIKKOR 8–15mm f/3.5–4.5E ED lenses use 12-mm circle)</li> <li>• <b>Spot:</b> Meters 4 mm circle (about 1.5% of frame) centered on selected focus point (on center focus point when non-CPU or AF-S Fisheye NIKKOR 8–15mm f/3.5–4.5E ED lens is used)</li> <li>• <b>Highlight-weighted:</b> Available with type G, E, and D lenses</li> </ul>
Range (ISO 100, f/1.4 lens, 20 °C/68 °F)	<ul style="list-style-type: none"> <li>• <b>Matrix or center-weighted metering:</b> –3–+20 EV</li> <li>• <b>Spot metering:</b> 2–20 EV</li> <li>• <b>Highlight-weighted metering:</b> 0–20 EV</li> </ul>
Exposure meter coupling	Combined CPU and AI

Exposure	
<b>Exposure mode</b>	Programmed auto with flexible program ( <b>P</b> ); shutter-priority auto ( <b>S</b> ); aperture-priority auto ( <b>A</b> ); manual ( <b>M</b> )
<b>Exposure compensation</b>	-5 – +5 EV in increments of 1/3, 1/2, or 1 EV
<b>Exposure lock</b>	Luminosity locked at detected value
<b>ISO sensitivity (Recommended Exposure Index)</b>	ISO 64 – 25600 in steps of 1/3, 1/2, or 1 EV. Can also be set to approx. 0.3, 0.5, 0.7, or 1 EV (ISO 32 equivalent) below ISO 64 or to approx. 0.3, 0.5, 0.7, 1, or 2 EV (ISO 102400 equivalent) above ISO 25600; auto ISO sensitivity control available
<b>Active D-Lighting</b>	Can be selected from <b>Auto</b> , <b>Extra high</b> , <b>High</b> , <b>Normal</b> , <b>Low</b> , or <b>Off</b>
Focus	
<b>Autofocus</b>	Multi-CAM 20K autofocus sensor module with TTL phase detection, fine-tuning, and 153 focus points (including 99 cross-type sensors and 15 sensors that support f/8), of which 55 (35 cross-type sensors and 9 f/8 sensors) are available for selection
<b>Detection range</b>	-4 – +20 EV (ISO 100, 20 °C/68 °F)
<b>Lens servo</b>	<ul style="list-style-type: none"> <li>• <b>Autofocus (AF)</b>: Single-servo AF (<b>AF-S</b>); continuous-servo AF (<b>AF-C</b>); predictive focus tracking automatically activated according to subject status</li> <li>• <b>Manual focus (M)</b>: Electronic rangefinder can be used</li> </ul>
<b>Focus point</b>	153 focus points, of which 55 or 15 are available for selection
<b>AF-area mode</b>	Single-point AF, 9-, 25-, 72-, or 153- point dynamic-area AF, 3D-tracking, group-area AF, auto-area AF
<b>Focus lock</b>	Focus can be locked by pressing shutter-release button halfway (single-servo AF) or by pressing the center of the sub-selector

<b>Flash</b>	
<b>Flash control</b>	<b>TTL:</b> i-TTL flash control using RGB sensor with approximately 180K (180,000) pixels; i-TTL balanced fill-flash for digital SLR is used with matrix, center-weighted, and highlight-weighted metering, standard i-TTL fill-flash for digital SLR with spot metering
<b>Flash mode</b>	Front-curtain sync, slow sync, rear-curtain sync, red-eye reduction, red-eye reduction with slow sync, slow rear-curtain sync, off
<b>Flash compensation</b>	-3 – +1 EV in increments of $\frac{1}{3}$ , $\frac{1}{2}$ , or 1 EV
<b>Flash-ready indicator</b>	Lights when optional flash unit is fully charged; flashes after flash is fired at full output
<b>Accessory shoe</b>	ISO 518 hot-shoe with sync and data contacts and safety lock
<b>Nikon Creative Lighting System (CLS)</b>	i-TTL flash control, radio-controlled Advanced Wireless Lighting, optical Advanced Wireless Lighting, modeling illumination, FV lock, Color Information Communication, Auto FP High-Speed Sync, AF-assist for multi-area AF, unified flash control
<b>Sync terminal</b>	ISO 519 sync terminal with locking thread
<b>White balance</b>	
<b>White balance</b>	Auto (3 types), natural light auto, incandescent, fluorescent (7 types), direct sunlight, flash, cloudy, shade, preset manual (up to 6 values can be stored, spot white balance measurement available during live view), choose color temperature (2500 K–10,000 K), all with fine-tuning.
<b>Bracketing</b>	
<b>Bracketing types</b>	Exposure, flash, white balance, and ADL

Live view	
<b>Modes</b>	📷 (photo live view), 🎬 (movie live view)
<b>Lens servo</b>	<ul style="list-style-type: none"> <li>• <b>Autofocus (AF):</b> Single-servo AF (<b>AF-S</b>); full-time-servo AF (<b>AF-F</b>)</li> <li>• <b>Manual focus (M)</b></li> </ul>
<b>AF-area mode</b>	Face-priority AF, wide-area AF, normal-area AF, pinpoint AF, subject-tracking AF
<b>Autofocus</b>	Contrast-detect AF anywhere in frame (camera selects focus point automatically when face-priority AF or subject-tracking AF is selected)
Movie	
<b>Metering system</b>	TTL exposure metering using main image sensor
<b>Metering mode</b>	Matrix, center-weighted, or highlight-weighted
<b>Frame size (pixels) and frame rate</b>	<ul style="list-style-type: none"> <li>• 3840 × 2160 (4K UHD); 30p (progressive), 25p, 24p</li> <li>• 1920 × 1080; 60p, 50p, 30p, 25p, 24p</li> <li>• 1280 × 720; 60p, 50p</li> <li>• 1920×1080 (slow-mo); 30p×4, 25p×4, 24p×5</li> </ul> <p>Actual frame rates for 60p, 50p, 30p, 25p, and 24p are 59.94, 50, 29.97, 25, and 23.976 fps respectively; quality selection available at all sizes except 3840 × 2160 (when quality is fixed at ★) and 1920 × 1080 slow-mo (when quality is fixed at “normal”)</p>
<b>File format</b>	MOV, MP4
<b>Video compression</b>	H.264/MPEG-4 Advanced Video Coding
<b>Audio recording format</b>	Linear PCM, AAC
<b>Audio recording device</b>	Built-in stereo or external microphone; sensitivity adjustable

Movie	
<b>ISO sensitivity (Recommended Exposure Index)</b>	<ul style="list-style-type: none"> <li>• <b>Exposure modes P, S, and A:</b> Auto ISO sensitivity control (ISO 64 to Hi 2) with selectable upper limit</li> <li>• <b>Exposure mode M:</b> Auto ISO sensitivity control (ISO 64 to Hi 2) available with selectable upper limit; manual selection (ISO 64 to 25600 in steps of 1/3, 1/2, or 1 EV) with additional options available equivalent to approximately 0.3, 0.5, 0.7, 1, or 2 EV (ISO 102400 equivalent) above ISO 25600</li> </ul>
<b>Active D-Lighting</b>	Can be selected from <b>Same as photo settings, Extra high, High, Normal, Low, or Off</b>
<b>Other options</b>	Index marking, time-lapse movies, electronic vibration reduction
Monitor	
<b>Monitor</b>	8-cm/3.2-in., approx. 2359k-dot (XGA) tilting TFT touch-sensitive LCD with 170° viewing angle, approximately 100% frame coverage, and manual monitor brightness control
Playback	
<b>Playback</b>	Full-frame and thumbnail (4, 9, or 72 images) playback with playback zoom, playback zoom cropping, movie playback, photo and/or movie slide shows, histogram display, highlights, photo information, location data display, picture rating, and auto image rotation
Interface	
<b>USB</b>	SuperSpeed USB (USB 3.0 Micro-B connector); connection to built-in USB port is recommended
<b>HDMI output</b>	Type C HDMI connector



Interface	
<b>Audio input</b>	Stereo mini-pin jack (3.5mm diameter; plug-in power supported)
<b>Audio output</b>	Stereo mini-pin jack (3.5mm diameter)
<b>Ten-pin remote terminal</b>	Can be used to connect optional MC-30A/ MC-36A remote cords, ML-3 modulite remote control sets, WR-R10 (requires WR-A10 adapter) or WR-1 wireless remote controllers, or GP-1/ GP-1A GPS units
Wi-Fi/Bluetooth	
<b>Wi-Fi</b>	<ul style="list-style-type: none"> <li>• <b>Standards:</b> IEEE 802.11b, IEEE 802.11g</li> <li>• <b>Operating frequency:</b> 2412–2462 MHz (channels 1–11)</li> <li>• <b>Maximum output power:</b> 8.5 dBm (EIRP)</li> <li>• <b>Authentication:</b> Open system, WPA2-PSK</li> </ul>
<b>Bluetooth</b>	<ul style="list-style-type: none"> <li>• <b>Communication protocols:</b> Bluetooth Specification Version 4.1</li> <li>• <b>Operating frequency:</b> Bluetooth: 2402–2480 MHz Bluetooth Low Energy: 2402–2480 MHz</li> </ul>
<b>Range (line of sight)</b>	Approximately 10 m (32 ft) without interference; range may vary with signal strength and presence or absence of obstacles
Supported languages	
<b>Supported languages</b>	Arabic, Bengali, Bulgarian, Chinese (Simplified and Traditional), Czech, Danish, Dutch, English, Finnish, French, German, Greek, Hindi, Hungarian, Indonesian, Italian, Japanese, Korean, Marathi, Norwegian, Persian, Polish, Portuguese (Portugal and Brazil), Romanian, Russian, Serbian, Spanish, Swedish, Tamil, Telugu, Thai, Turkish, Ukrainian, Vietnamese

Power source	
<b>Battery</b>	One EN-EL15a rechargeable Li-ion battery; EN-EL15 can also be used, but note that fewer pictures can be taken on a single charge than with an EN-EL15a (□ 365)
<b>Battery pack</b>	Optional MB-D18 multi-power battery pack with one rechargeable Nikon EN-EL18b Li-ion battery (available separately), one rechargeable Nikon EN-EL15a Li-ion battery, or eight AA alkaline, Ni-MH, or lithium batteries. An MH-26a or MH-26 battery charger and a BL-5 battery-chamber cover (both available separately) are required when using EN-EL18b batteries. EN-EL18a, EN-EL18, and EN-EL15 batteries are also supported, but note that fewer pictures can be taken on a single charge with an EN-EL18 than with an EN-EL18b/EN-EL18a, and that fewer pictures can be taken on a single charge with an EN-EL15 than with an EN-EL15a (□ 365).
<b>AC adapter</b>	EH-5c/EH-5b AC adapter; requires EP-5B power connector (available separately)
Tripod socket	
<b>Tripod socket</b>	1/4 in. (ISO 1222)
Dimensions/weight	
<b>Dimensions (W × H × D)</b>	Approx. 146 × 124 × 78.5 mm (5.8 × 4.9 × 3.1 in.)
<b>Weight</b>	Approx. 1005 g (2 lb. 3.5 oz.) with battery and XQD memory card but without body cap; approx. 915 g/2 lb. 0.3 oz. (camera body only)
Operating environment	
<b>Temperature</b>	0 °C–40 °C (+32 °F–104 °F)
<b>Humidity</b>	85% or less (no condensation)

- Unless otherwise stated, all measurements are performed in conformity with Camera and Imaging Products Association (CIPA) standards or guidelines.
- All figures are for a camera with a fully-charged battery.
- Nikon reserves the right to change the appearance and specifications of the hardware and software described in this manual at any time and without prior notice. Nikon will not be held liable for damages that may result from any mistakes that this manual may contain.

## ■■ MH-25a Battery Charger

<b>Rated input</b>	AC 100–240 V, 50/60 Hz, 0.23–0.12 A
<b>Rated output</b>	DC 8.4 V/1.2 A
<b>Supported batteries</b>	Nikon EN-EL15a rechargeable Li-ion batteries
<b>Charging time</b>	Approx. 2 hours and 35 minutes at an ambient temperature of 25 °C (77 °F) when no charge remains
<b>Operating temperature</b>	0 °C–40 °C (+32 °F–104 °F)
<b>Dimensions (W × H × D)</b>	Approx. 95 × 33.5 × 71 mm (3.7 × 1.3 × 2.8 in.), excluding projections
<b>Length of power cable (if supplied)</b>	Approx. 1.5 m (4.9 ft)
<b>Weight</b>	Approx. 115 g (4.1 oz), excluding supplied power connector (power cable or AC wall adapter)

The symbols on this product represent the following:

~ AC, --- DC, □ Class II equipment (The construction of the product is double-insulated.)

## ■■ EN-EL15a Rechargeable Li-ion Battery

<b>Type</b>	Rechargeable lithium-ion battery
<b>Rated capacity</b>	7.0 V/1900 mAh
<b>Operating temperature</b>	0 °C–40 °C (+32 °F–104 °F)
<b>Dimensions (W × H × D)</b>	Approx. 40 × 56 × 20.5 mm (1.6 × 2.2 × 0.8 in.)
<b>Weight</b>	Approx. 78 g (2.8 oz), excluding terminal cover

Nikon reserves the right to change the appearance and specifications of the hardware and software described in this manual at any time and without prior notice. Nikon will not be held liable for damages that may result from any mistakes that this manual may contain.

## Trademark Information

IOS is a trademark or registered trademark of Cisco Systems, Inc., in the United States and/or other countries and is used under license.

Windows is either a registered trademark or a trademark of Microsoft Corporation in the United States and/or other countries. Mac, macOS, OS X, Apple®, App Store®, the Apple logos, iPhone®, iPad®, and iPod touch® are trademarks of Apple Inc. registered in the U.S. and/or other countries. Android is a trademark of Google Inc. The Android robot is reproduced or modified from work created and shared by Google and used according to terms described in the Creative Commons 3.0 Attribution License. PictBridge logo is a trademark. XQD is a trademark of Sony Corporation. The SD, SDHC, and SDXC logos are trademarks of the SD-3C, LLC. HDMI, the HDMI logo and High-Definition Multimedia Interface are trademarks or registered trademarks of HDMI Licensing, LLC.

## **HDMI**

Wi-Fi and the Wi-Fi logo are trademarks or registered trademarks of the Wi-Fi Alliance.

The Bluetooth® word mark and logos are registered trademarks owned by Bluetooth SIG, Inc. and any use of such marks by Nikon Corporation is under license.

All other trade names mentioned in this manual or the other documentation provided with your Nikon product are trademarks or registered trademarks of their respective holders.

“Made for iPod,” “Made for iPhone,” and “Made for iPad” mean that an electronic accessory has been designed to connect specifically to iPod, iPhone, or iPad, respectively, and has been certified by the developer to meet Apple performance standards. Apple is not responsible for the operation of this device or its compliance with safety and regulatory standards. Please note that the use of this accessory with iPod, iPhone, or iPad may affect wireless performance.

### **Supported Standards**

- **DCF Version 2.0:** The Design Rule for Camera File System (DCF) is a standard widely used in the digital camera industry to ensure compatibility among different makes of camera.
- **Exif version 2.31:** The camera supports Exif (Exchangeable Image File Format for Digital Still Cameras) version 2.31, a standard in which information stored with photographs is used for optimal color reproduction when the images are output on Exif-compliant printers.
- **PictBridge:** A standard developed through cooperation with the digital camera and printer industries, allowing photographs to be output directly to a printer without first transferring them to a computer.
- **HDMI: High-Definition Multimedia Interface** is a standard for multimedia interfaces used in consumer electronics and AV devices capable of transmitting audiovisual data and control signals to HDMI-compliant devices via a single cable connection.

### **Conformity Marking**

The standards with which the camera complies can be viewed using the **Conformity marking** option in the setup menu (📖 276).

## Certificates

### • México

**IFETEL: RCPMULB16-0363**

**LBEE5UW1FS**

Módulo WLAN instalado adentro de esta computadora

La operación de este equipo está sujeta a las siguientes dos condiciones:

- (1) es posible que este equipo o dispositivo no cause interferencia perjudicial y
- (2) este equipo o dispositivo debe aceptar cualquier interferencia, incluyendo la que pueda causar su operación no deseada.

• عُمان

**OMAN-TRA**

**R/4615/17**

**D090024**

• الإمارات العربية المتحدة

**TRA**

**REGISTERED No:**

**ER45171/16**

**DEALER No:**

**DA39487/15**

### • Maroc/

المغرب

**AGREE PAR L'ANRT MAROC**

**Numéro d'agrément : MR 14372 ANRT 2017**

**Date d'agrément : 20/07/2017**

## FreeType License (FreeType2)

Portions of this software are copyright © 2012 The FreeType Project (<http://www.freetype.org>). All rights reserved.

## MIT License (HarfBuzz)

Portions of this software are copyright © 2017 The HarfBuzz Project (<http://www.freedesktop.org/wiki/Software/HarfBuzz>). All rights reserved.

## AF-S NIKKOR 24–120mm f/4G ED VR Lenses

Read this section if you purchased the camera with the AF-S NIKKOR 24–120mm f/4G ED VR lens kit available in some countries or regions. The parts of the lens are listed below.

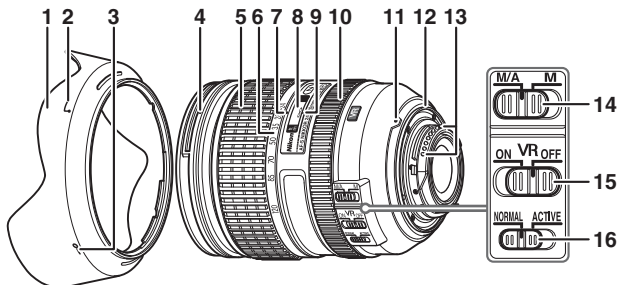

<b>1</b> Lens hood .....357	<b>10</b> Focus ring ..... 111
<b>2</b> Lens hood alignment mark .....357	<b>11</b> Lens mounting mark..... 19
<b>3</b> Lens hood lock mark.....357	<b>12</b> Rubber lens-mount gasket
<b>4</b> Lens hood mounting mark.....357	<b>13</b> CPU contacts.....284
<b>5</b> Zoom ring	<b>14</b> Focus-mode switch ..... 111
<b>6</b> Focal length scale	<b>15</b> Vibration reduction switch .....355
<b>7</b> Focal length mark	<b>16</b> Vibration reduction mode switch
<b>8</b> Focus distance indicator	.....355
<b>9</b> Focus distance mark	

## ■ ■ Focus

Supported focus modes are shown in the following table (for information on camera focus modes, see the camera manual).

Camera focus mode	Lens focus mode	
	M/A	M
AF	Autofocus with manual override (manual priority)	Manual focus with electronic rangefinder
MF	Manual focus with electronic rangefinder	

### M/A (Autofocus with Manual Override)

To focus using autofocus with manual override (M/A):

- 1 **Slide the lens focus-mode switch to M/A.**
- 2 **Focus.**

If desired, autofocus can be over-riden by rotating the lens focus ring while the shutter-release button is pressed halfway (or, if the camera is equipped with an **AF-ON** button, while the **AF-ON** button is pressed). To refocus using autofocus, press the shutter-release button halfway or press the **AF-ON** button again.



## ■ ■ *Zoom and Depth of Field*

Before focusing, rotate the zoom ring to adjust the focal length and frame the photograph. If the camera offers depth-of-field preview (stop down), depth of field can be previewed in the viewfinder.

**Note:** The lens uses Nikon's Internal Focusing (IF) system. Unlike other lenses, focal length decreases as the focus distance shortens. Note that the focus distance indicator is intended only as a guide and may not accurately show the distance to the subject and may, due to depth of field or other factors, not show ∞ when the camera is focused on a distant object.

## ■ ■ *Aperture*

Aperture is adjusted using camera controls.



## ■ ■ Using the Built-in Flash

When using the built-in flash, be sure the subject is at a range of at least 0.6 m (2 ft) and remove lens hoods to prevent vignetting (shadows created where the end of the lens obscures the built-in flash).

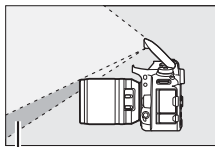

Shadow

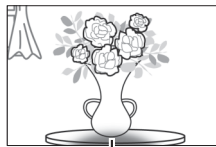

Vignetting

When the lens is mounted on the following cameras, the built-in flash may be unable to light the entire subject at ranges less than those given below:

Camera	Zoom position	Minimum distance without vignetting
D750 (FX format)/ D610 (FX format)/ D600 (FX format)	24 mm	2.0 m/6 ft 7 in.
	28 mm	1.0 m/3 ft 4 in.
	50–120 mm	No vignetting
D810 series (FX format)/ D800 series (FX format)	28 mm	1.0 m/3 ft 4 in.
	35–120 mm	No vignetting
D700 (FX format)	24 mm	3.0 m/9 ft 11 in.
	35–120 mm	No vignetting
D300 series/D200/D100	24 mm	1.0 m/3 ft 4 in.
	35–120 mm	No vignetting
D90/D80/D70 series/D50	24 mm	1.5 m/5 ft
	35–120 mm	No vignetting
D5600/D5500/D5300/D5200/ D5100/D3300/D3200	24 mm	1.5 m/5 ft
	28–120 mm	No vignetting

Camera	Zoom position	Minimum distance without vignetting
D5000/D3100/D3000/D60/ D40 series	24 mm	2.5 m/8 ft 3 in.
	35–120 mm	No vignetting
D3400	24 mm	1.5 m/5 ft
	28 mm	1.0 m/3 ft 4 in.
	35–120 mm	No vignetting

## ■ ■ *Vibration Reduction (VR)*

### Using the Vibration Reduction ON/OFF Switch

- Select **ON** to enable vibration reduction. Vibration reduction is activated when the shutter-release button is pressed halfway, reducing the effects of camera shake for improved framing and focus.
- Select **OFF** to turn vibration reduction off.

### Using the Vibration Reduction Mode Switch

- Select **NORMAL** for enhanced vibration reduction when photographing stationary subjects.
- Select **ACTIVE** to reduce the effects of vibration when shooting from a moving vehicle, and in other situations with active camera motion.



### ✔ Using Vibration Reduction: Notes

- When using vibration reduction, press the shutter-release button halfway and wait for the image in the viewfinder to stabilize before pressing the shutter-release button the rest of the way down.
- When vibration reduction is active, the image in the viewfinder may jiggle after the shutter is released. This does not indicate a malfunction.
- Slide the vibration reduction mode switch to **NORMAL** for panning shots. When the camera is panned, vibration reduction applies only to motion that is not part of a pan (if the camera is panned horizontally, for example, vibration reduction will be applied only to vertical shake), making it much easier to pan the camera smoothly in a wide arc.
- Do not turn the camera off or remove the lens while vibration reduction is in effect. If power to the lens is cut while vibration reduction is on, the lens may rattle when shaken. This is not a malfunction, and can be corrected by reattaching the lens and turning the camera on.
- If the camera is equipped with a built-in flash, vibration reduction will be disabled while the flash charges.
- In the case of cameras equipped with an **AF-ON** button, vibration reduction will not be performed when the **AF-ON** button is pressed.
- Select **OFF** when the camera is mounted on a tripod unless the tripod head is unsecured or the camera is mounted on a monopod, in which case **ON** is recommended.

## ■ ■ *The Lens Hood*

The lens hoods protect the lens and block stray light that would otherwise cause flare or ghosting.

### Attaching the Hood

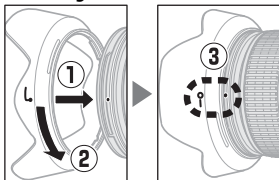

Align the lens hood mounting mark (●) with the lens hood alignment mark (└) and then rotate the hood (②) until the ● mark is aligned with the lens hood lock mark (—○).

When attaching or removing the hood, hold it near the symbol on its base and avoid gripping it too tightly. Vignetting may occur if the hood is not correctly attached. The hood can be reversed and mounted on the lens when not in use.

## ■ ■ *Supplied Accessories*

- LC-77 77 mm snap-on Front Lens Cap
- LF-4 Rear Lens Cap
- HB-53 Bayonet Hood
- CL-1218 Flexible Lens Pouch

## ■ ■ *Compatible Accessories*

77 mm screw-on filters

## ■ Specifications

Type	Type G AF-S lens with built-in CPU and F mount
Focal length	24–120 mm
Maximum aperture	f/4
Lens construction	17 elements in 13 groups (including 2 ED lens elements, 3 aspherical lens elements, and lens elements with Nano-Crystal coatings)
Angle of view	<ul style="list-style-type: none"><li>• Nikon FX-format D-SLR cameras: 84° – 20° 20'</li><li>• Nikon DX-format D-SLR cameras: 61° – 13° 20'</li></ul>
Focal length scale	Graduated in millimeters (24, 28, 35, 50, 70, 85, 120)
Distance information	Output to camera
Zoom	Manual zoom using independent zoom ring
Focusing	Nikon Internal Focusing (IF) System with autofocus controlled by Silent Wave Motor and separate focus ring for manual focus
Vibration reduction	Lens shift using voice coil motors (VCMs)
Focus distance indicator	0.45 m to infinity ( $\infty$ )
Minimum focus distance	0.45 m (1.48 ft) from focal plane at all zoom positions
Diaphragm blades	9 (rounded diaphragm opening)
Diaphragm	Fully automatic
Aperture range	f/4–22
Metering	Full aperture
Filter-attachment size	77 mm (P = 0.75 mm)
Dimensions	Approx. 84 mm maximum diameter × 103.5 mm (distance from camera lens mount flange)
Weight	Approx. 710 g (1 lb 9.1 oz)

Nikon reserves the right to change the appearance and specifications of the hardware and software described in this manual at any time and without prior notice. Nikon will not be held liable for damages that may result from any mistakes that this manual may contain.

### Lens Care

- Keep the CPU contacts clean.
- Should the rubber lens-mount gasket be damaged, cease use immediately and take the lens to a Nikon-authorized service center for repair.
- Use a blower to remove dust and lint from the lens surfaces. To remove smudges and fingerprints, apply a small amount of ethanol or lens cleaner to a soft, clean cotton cloth or lens-cleaning tissue and clean from the center outwards using a circular motion, taking care not to leave smears or touch the glass with your fingers.
- Never use organic solvents such as paint thinner or benzene to clean the lens.
- The lens hood or Neutral Color (NC) filters can be used to protect the front lens element.
- Attach the front and rear caps before placing the lens in its case.
- When a lens hood is attached, do not pick up or hold the lens or camera using only the hood.
- If the lens will not be used for an extended period, store it in a cool, dry location to prevent mold and rust. Do not store in direct sunlight or with naphtha or camphor moth balls.
- Keep the lens dry. Rusting of the internal mechanism can cause irreparable damage.
- Leaving the lens in extremely hot locations could damage or warp parts made from reinforced plastic.

## Approved Memory Cards

The camera accepts the XQD and SD memory cards listed in the following sections. Other cards have not been tested. For more details on the cards listed below, please contact the manufacturer.

### ■ XQD Memory Cards

The following XQD memory cards have been tested and approved for use in the camera.

Sony	G series	QD-G32A/QD-G32E	32 GB
		QD-G64A/QD-G64E	64 GB
		QD-G128A/QD-G128E	128 GB
		QD-G256E	256 GB
	M series	QD-M32A	32 GB
		QD-M64A	64 GB
		QD-M128A	128 GB
	S series	QD-S32/QD-S32E	32 GB
		QD-S64/QD-S64E	64 GB
	H series	QD-H16	16 GB
		QD-H32	32 GB
	N series	QD-N32	32 GB
QD-N64		64 GB	
Lexar	Professional	1100 ×	32 GB, 64 GB
		1333 ×	32 GB, 64 GB
		1400 ×	32 GB, 64 GB
		2933 ×	32 GB, 64 GB, 128 GB

Cards with write speeds of 45 MB/s (300×) or better are recommended for movie recording. Slower speeds may interrupt recording or cause jerky, uneven playback.



## ■ ■ *SD Memory Cards*

The camera supports SD, SDHC, and SDXC memory cards, including SDHC and SDXC cards compliant with UHS-I and UHS-II. Cards rated UHS Speed Class



3 or better are recommended for movie recording; using slower cards may result in recording being interrupted. When choosing cards for use in card readers, be sure they are compatible with the device. Contact the manufacturer for information on features, operation, and limitations on use.



## Memory Card Capacity

The following table shows the approximate number of pictures that can be stored on a 64 GB Sony QD-G64E XQD card at different image quality, image size, and image area settings.

### ■ FX (36×24) Image Area\*

Image quality	Image size	File size <sup>1</sup>	No. of images <sup>1</sup>	Buffer capacity <sup>2</sup>
NEF (RAW), Lossless compressed, 12-bit	Large	41.5 MB	763	170
	Medium	30.0 MB	1000	94
	Small	21.9 MB	1400	56
NEF (RAW), Lossless compressed, 14-bit	Large	51.6 MB	589	51
NEF (RAW), Compressed, 12-bit	Large	34.2 MB	1000	200
NEF (RAW), Compressed, 14-bit	Large	43.8 MB	865	74
NEF (RAW), Uncompressed, 12-bit	Large	70.3 MB	763	55
NEF (RAW), Uncompressed, 14-bit	Large	92.0 MB	589	29
TIFF (RGB)	Large	134.6 MB	408	32
	Medium	76.6 MB	718	35
	Small	34.9 MB	1500	39
JPEG fine <sup>3</sup>	Large	22.0 MB	1900	200
	Medium	12.6 MB	3200	200
	Small	6.6 MB	6700	200
JPEG normal <sup>3</sup>	Large	11.5 MB	3800	200
	Medium	6.8 MB	6400	200
	Small	3.4 MB	13,000	200
JPEG basic <sup>3</sup>	Large	4.2 MB	7400	200
	Medium	2.8 MB	12,500	200
	Small	1.8 MB	24,500	200

\* Includes images taken with non-DX lenses when **On** is selected for **Auto DX crop**.

## ■ ■ DX (24 × 16) Image Area\*

Image quality	Image size	File size <sup>1</sup>	No. of images <sup>1</sup>	Buffer capacity <sup>2</sup>
NEF (RAW), Lossless compressed, 12-bit	Large	19.4 MB	1700	200
	Medium	14.1 MB	2300	200
	Small	11.0 MB	3000	200
NEF (RAW), Lossless compressed, 14-bit	Large	23.9 MB	1300	200
NEF (RAW), Compressed, 12-bit	Large	15.9 MB	2300	200
NEF (RAW), Compressed, 14-bit	Large	19.8 MB	1900	200
NEF (RAW), Uncompressed, 12-bit	Large	30.8 MB	1700	200
NEF (RAW), Uncompressed, 14-bit	Large	40.2 MB	1300	200
TIFF (RGB)	Large	58.4 MB	936	113
	Medium	33.3 MB	1600	200
	Small	15.6 MB	3400	200
JPEG fine <sup>3</sup>	Large	10.1 MB	4200	200
	Medium	6.2 MB	6900	200
	Small	3.4 MB	12,900	200
JPEG normal <sup>3</sup>	Large	5.3 MB	8200	200
	Medium	3.3 MB	13,500	200
	Small	1.8 MB	24,500	200
JPEG basic <sup>3</sup>	Large	2.4 MB	15,900	200
	Medium	1.7 MB	25,100	200
	Small	1.0 MB	43,100	200

\* Includes images taken with DX lenses when **On** is selected for **Auto DX crop**.

- 1 All figures are approximate. File size varies with scene recorded.
- 2 Maximum number of exposures that can be stored in memory buffer at ISO 100. May drop in some situations, for example at image qualities marked with a star (“★”) or if auto distortion control is on.
- 3 Figures assume size-priority JPEG compression. Selecting an image-quality option marked with a star (“★”; optimal compression) increases the file size of JPEG images; number of images and buffer capacity drop accordingly.

#### **d2—Max. Continuous Release** (📖 264)

The maximum number of photographs that can be taken in a single burst can be set to any amount between 1 and 200.

## Battery Life

The movie footage or number of shots that can be recorded with fully-charged batteries varies with the condition of the battery, temperature, interval between shots, and the length of time menus are displayed. In the case of AA batteries, capacity also varies with make and storage conditions; some batteries cannot be used. Sample figures for the camera and optional MB-D18 multi-power battery pack are given below.

- **Photographs, single-frame release mode (CIPA standard <sup>1</sup>)**
  - **One EN-EL15a battery<sup>2</sup> (camera):** Approximately 1840 shots
  - **One EN-EL15a battery<sup>2</sup> (MB-D18):** Approximately 1840 shots
  - **One EN-EL18b battery<sup>3</sup> (MB-D18):** Approximately 3300 shots
  - **Eight AA alkaline batteries (MB-D18):** Approximately 1740 shots
- **Photographs, continuous release mode (Nikon standard <sup>4</sup>)**
  - **One EN-EL15a battery<sup>2</sup> (camera):** Approximately 4030 shots
  - **One EN-EL15a battery<sup>2</sup> (MB-D18):** Approximately 4030 shots
  - **One EN-EL18b battery<sup>3</sup> (MB-D18):** Approximately 7700 shots
  - **Eight AA alkaline batteries (MB-D18):** Approximately 2960 shots
- **Movies<sup>5</sup>**
  - **One EN-EL15a battery<sup>2</sup> (camera):** Approximately 70 minutes of HD footage
  - **One EN-EL15a battery<sup>2</sup> (MB-D18):** Approximately 70 minutes of HD footage
  - **One EN-EL18b battery<sup>3</sup> (MB-D18):** Approximately 145 minutes of HD footage
  - **Eight AA alkaline batteries (MB-D18):** Approximately 65 minutes of HD footage

- 1 Measured at 23 °C/73.4 °F ( $\pm 2$  °C/3.6 °F) with an AF-S NIKKOR 24–120mm f/4G ED VR lens under the following test conditions: lens cycled from infinity to minimum range and one photograph taken at default settings once every 30 s. Live view not used.
- 2 EN-EL15 batteries can also be used in place of the EN-EL15a, but note that fewer pictures can be taken on a single charge.
- 3 Requires MH-26a or MH-26 battery charger and BL-5 battery-chamber cover (both available separately). EN-EL18a and EN-EL18 batteries can be used in place of the EN-EL18b, but note that fewer pictures can be taken on a single charge with an EN-EL18 than with an EN-EL18b/EN-EL18a.
- 4 Measured at 23 °C/73.4 °F ( $\pm 2$  °C/3.6 °F) with an AF-S NIKKOR 70–200mm f/2.8E FL ED VR lens under the following test conditions: vibration reduction off, image quality set to JPEG normal, image size set to **Large**, shutter speed  $\frac{1}{250}$  s, focus cycled from infinity to minimum range three times after shutter-release button has been pressed halfway for 3 s; six shots are then taken in succession and monitor turned on for 5 s and then turned off; cycle repeated once standby timer has expired.
- 5 Measured at 23 °C/73.4 °F ( $\pm 2$  °C/3.6 °F) with the camera at default settings and an AF-S NIKKOR 24–120mm f/4G ED VR lens under conditions specified by the Camera and Imaging Products Association (CIPA). Individual movies are composed of one or more files, each up to 4 GB in size, and can total up to 29 minutes 59 seconds in length; recording may end before these limits are reached if the camera temperature rises.

Actions such as the following can reduce battery life:





















- Using the monitor
- Keeping the shutter-release button pressed halfway
- Repeated autofocus operations
- Taking NEF (RAW) or TIFF (RGB) photographs
- Slow shutter speeds
- Using camera Wi-Fi (wireless LAN) and Bluetooth features
- Using the camera with optional accessories connected
- Using VR (vibration reduction) mode with VR lenses
- Repeatedly zooming in and out with an AF-P lens.

To ensure that you get the most from rechargeable Nikon EN-EL15a batteries:

- Keep the battery contacts clean. Soiled contacts can reduce battery performance.
- Use batteries immediately after charging. Batteries will lose their charge if left unused.

# Index

## Symbols

<b>P</b> (Programmed auto).....	126, 128
<b>S</b> (Shutter-priority auto) .....	126, 129
<b>A</b> (Aperture-priority auto) .....	126, 130
<b>M</b> (Manual).....	126, 131
<b>S</b> (Single frame) .....	113
<b>CL</b> (Continuous low speed) ...	113, 264
<b>CH</b> (Continuous high speed).....	113
<b>Q</b> (Quiet shutter-release) .....	113
<b>QC</b> (Quiet continuous shutter- release).....	113
 (Self-timer) .....	113, 116, 264
<b>MUP</b> .....	114, 118
 (Single-point AF) .....	100
 (Dynamic-area AF) .....	100
 (3D-tracking).....	101
 (Group-area AF) .....	101
 (Auto-area AF) .....	101
 (Face-priority AF).....	42
 (Wide-area AF).....	42
 (Normal-area AF) .....	42
 (Pinpoint AF) .....	42
 (Subject-tracking AF).....	43
 (Matrix).....	124
 (Center-weighted) .....	124
 (Spot).....	124
 * (Highlight-weighted) .....	124
 (Info) button .....	55, 72, 203
 (Live view) .....	37, 59, 169, 270
<b>?</b> (Help) .....	25
 (Memory buffer) .....	115, 362
<b>i</b> button.....	45, 65, 200, 208, 228
 switch .....	6, 270
 (Focus indicator).....	33, 108, 112
<b>PRE</b> (Preset manual) .....	157, 165

## Numerics

1 : 1 (24 × 24) .....	84
1.2× (30 × 20).....	84
12-bit .....	90
14-bit .....	90
3D color matrix metering III .....	124
3D-tracking .....	101, 102, 260
3D-tracking face-detection .....	260
3D-tracking watch area .....	261
5 : 4 (30 × 24) .....	84

## A

AC adapter .....	296
Accessories.....	296
Accessory shoe .....	187, 296
Active D-Lighting.....	45, 65, 152, 180, 253, 258
Add items (My Menu).....	280
ADL bracketing (Auto bracketing set).....	142, 152
Adobe RGB .....	253
AE & flash bracketing (Auto bracketing set) .....	142
AE bracketing (Auto bracketing set) 142	
AF.....	41–43, 94–110, 260–262
AF activation.....	261
AF area brackets.....	7, 9
AF fine-tune .....	272
AF-area mode.....	42, 100, 261
AF-C .....	98, 260
AF-F.....	41
<b>AF-ON</b> button.....	99, 261, 268
AF-S.....	41, 98, 260
After burst, show .....	249
After delete .....	249
Airplane mode .....	275

Angle of view ..... 286  
 Aperture ..... 130, 131, 136, 268  
 Aperture lock ..... 136, 268  
 Aperture-priority auto ..... 130  
 Aspect ratio ..... 68, 84  
 Assign MB-D18 buttons ..... 270  
 Assign remote (WR) Fn button.... 274  
 Attaching the lens ..... 19  
 Attenuator ..... 65, 259  
 Audio ..... 61  
 Audio output ..... 345  
 Auto (Set Picture Control) ..... 175  
 Auto (White balance) ..... 156, 159  
 Auto bracketing ..... 142, 254, 267  
 Auto bracketing (mode M) ..... 267  
 Auto bracketing set ..... 142, 254  
 Auto distortion control ..... 253  
 Auto DX crop ..... 84  
 Auto external flash ..... 190, 198  
 Auto FP high-speed sync ..... 266  
 Auto image rotation ..... 249  
 Auto ISO sensitivity control. 121, 257  
 Auto  $\downarrow$  ISO sensitivity control ..... 267  
 Auto-area AF ..... 101, 103  
 Autofocus... 41–43, 94–110, 260–262  
 Autofocus mode ..... 41, 98, 262  
 Autofocus mode restrictions ..... 262

## B

Backlight ..... 6  
 Backup (Secondary slot function). 93  
 Battery ..... 14, 16, 30, 276, 347  
 Battery info ..... 276  
 Battery order ..... 276  
 Battery pack .. 114, 270, 276, 296, 299  
 Beep options ..... 274  
**BKT** button ..... 143, 144, 148, 149, 152,  
 153, 186, 268  
 Black-and-white (Monochrome) 279  
 Blocked shot AF response ..... 260  
 Bluetooth ..... xx, 275

Body cap ..... 296  
 Bracketing ..... 142, 254, 267  
 Bracketing order ..... 267  
 Bulb ..... 133  
 Burst ..... 249, 264  
 Button backlights ..... 6, 265

## C

Camera Control Pro 2 ..... 297  
 Capture NX-D ..... ii  
 Center-weighted metering. 124, 263  
 Charging the battery ..... 14  
 Choose color temp. (White balance).  
 157, 163  
 Choose start/end point ..... 78  
 Choose tab ..... 280  
 CL mode shooting speed ..... 264  
 Clean image sensor ..... 272, 312  
 Clock ..... 23  
 Cloudy (White balance) ..... 157  
 CLS ..... 288  
 Color space ..... 253  
 Color temperature 156, 157, 160, 163  
 Compatible lenses ..... 281  
 Compressed (NEF (RAW)  
 compression) ..... 90  
 Conformity marking ..... 276, 349  
 Connect to smart device ..... 275  
 Connector for external microphone .  
 2  
 Continuous high speed ..... 113  
 Continuous low speed ..... 113, 264  
 Continuous release mode ..... 113  
 Continuous-servo AF ..... 98, 260  
 Control panel ..... 5  
 Copy image(s) ..... 249  
 Copyright information ..... 273  
 CPU contacts ..... 284  
 CPU lens ..... 20, 281, 284  
 Creative Lighting System ..... 288  
 Crop ..... 68



Custom control assignment 268, 270  
Custom Settings ..... 260  
Custom settings bank..... 260  
Customize command dials ..... 269  
Cyanotype (Monochrome) ..... 279

## D

---

Date and time ..... 23, 271  
Date format ..... 23, 271  
Daylight saving time ..... 23, 271  
DCF ..... 349  
Default settings..... 209, 256, 277  
Delete ..... 36, 245  
Delete all images ..... 246  
Delete current image ..... 36, 245  
Depth of field ..... 127  
Destination ..... 256  
Diopter ..... 9, 296  
Direct sunlight (White balance) .. 157  
Distance-priority manual..... 190, 199, 288  
Distortion control ..... 278  
D-Lighting ..... 278  
DX (24 × 16) ..... 84, 87  
DX format ..... 68, 83, 84, 85  
Dynamic-area AF ..... 100, 103, 262

## E

---

Easy exposure compensation ..... 263  
Electronic front-curtain shutter .... 45, 265  
Electronic rangefinder ..... 112  
Electronic VR ..... 66, 259  
EV steps for exposure cntrl ..... 262  
Exif ..... 349  
Exp./flash comp. step value ..... 262  
Exposure ..... 124, 126, 137, 139, 262  
Exposure bracketing ... 142, 143, 254, 267  
Exposure comp. for flash ..... 266  
Exposure compensation ..... 139, 263

Exposure delay mode ..... 264  
Exposure differential ..... 184  
Exposure indicator ..... 132  
Exposure lock ..... 137  
Exposure meters ..... 34, 263  
Exposure mode ..... 126  
Exposure preview ..... 39  
Extended photo menu banks ..... 250  
External GPS device options 221, 274  
External microphone ..... 67, 297  
Eye-Fi upload ..... 276

## F

---

Face detection ..... 260, 263  
Face-priority AF ..... 42  
File information ..... 230  
File naming ..... 250, 256  
File number sequence ..... 265  
Filter effects ..... 179, 279  
Fine-tune optimal exposure ..... 263  
Firmware version ..... 277  
Flash ..... 187, 192, 194, 196, 266, 288  
Flash (White balance) ..... 157  
Flash bracketing... 142, 143, 254, 267  
Flash bracketing (Auto bracketing set) ..... 142  
Flash compensation ..... 194  
Flash control ..... 189, 190, 251  
Flash info ..... 198  
Flash mode ..... 192, 193  
Flash shutter speed ..... 266  
Flash sync speed ..... 266  
Flash sync terminal ..... 188  
Flash-ready indicator... 187, 197, 293, 342  
Flat (Set Picture Control) ..... 175  
Flexible program ..... 128  
Flick ..... 12, 274  
Flicker reduction ..... 254, 258  
Fluorescent (White balance) ..... 157  
Fn1 button ..... 268, 270

<b>Fn2</b> button .....	242, 268, 270	HDR (high dynamic range).....	182
f-number .....	130, 284	Headphone volume.....	66
Focal length .....	220	Headphones .....	67
Focal length scale .....	351	Help .....	25
Focal plane mark.....	112	Hi.....	120
Focus .... 41–43, 44, 94–112, 260–262		Hide image.....	248
Focus indicator .....	33, 108, 112	High definition.....	349
Focus lock .....	108	High Dynamic Range (HDR) 182, 254	
Focus mode.....	41, 94, 111	High ISO NR .....	253, 258
Focus point.32, 42, 94, 100, 105, 261, 262		Highlight brightness .....	270
Focus point options .....	262	Highlight display.....	66
Focus point wrap-around .....	262	Highlights.....	231
Focus shift shooting.....	212	Highlight-weighted metering.....	124
Focus tracking .....	99, 260	Histogram.....	55, 72, 232, 233
Focus tracking with lock-on.....	260	<b>I</b>	
Focusing screen.....	338	Image area 45, 65, 83, 84, 86, 91, 251, 256	
Focus-mode selector .....	41, 94, 111	Image comment.....	273
Focus-mode switch .....	111	Image Dust Off ref photo.....	273
Format.....	271	Image overlay .....	279
Format memory card.....	271	Image quality .....	88, 251
Frame interval (Slide show).....	249	Image review.....	225, 249
Frame rate.....	69, 114	Image size.....	91, 251
Frame size/frame rate.....	69, 256	Incandescent (White balance) ....	156
Frequency response.....	65, 259	Index marking.....	64
Front-curtain sync.....	192	In-focus indicator.....	33, 108, 112
Full-frame playback.....	223	Information display. 55, 72, 198, 203, 272	
Full-frame playback flicks.....	274	Interval timer shooting.....	255
Full-time-servo AF.....	41	ISO display.....	264
FV lock.....	196	ISO sensitivity.....	119, 121, 252, 257
FX (36 × 24).....	84	ISO sensitivity settings.....	252, 257
FX format .....	84	ISO sensitivity step value .....	262
<b>G</b>		i-TTL .....	189, 190, 198, 288
GPS .....	221	<b>J</b>	
GPS unit .....	221, 297	JPEG .....	88, 92, 278
Group-area AF .....	101, 103	JPEG basic.....	88
<b>H</b>		JPEG fine .....	88
H.264.....	343	JPEG normal.....	88
HDMI.....	274, 349		

## L

L (large).....	74, 91
Landscape (Set Picture Control) .	175
Language .....	21, 271
LCD illumination.....	6, 265
LED lamp .....	274
Lens .....	19, 20, 218, 272, 281, 351
Lens focus ring .....	44, 111, 351
Lens mount .....	3, 19, 112
Lens mounting mark.....	2, 19
Lens vibration reduction switch .	355
Limit AF-area mode selection.....	261
LINK mode .....	274
Live view.....	37, 59
Live view button options .....	270
Live view in continuous mode ....	266
Live view photography .....	37–58
Live view selector.....	37, 59
Lo .....	120
Location data.....	221
Lock mirror up for cleaning .	272, 315
Long exposure NR.....	253
Lossless compressed (NEF (RAW) compression) .....	90

## M

M (Manual focus).....	44, 111
M (medium).....	74, 91
Manage Picture Control.....	252, 258
Manual (Exposure mode) .....	131
Manual (Flash control).....	191, 199
Manual focus.....	44, 111
Manual focus ring in AF mode ....	262
Matrix metering .....	124, 263
Max. continuous release .....	264
Maximum aperture..	44, 54, 218, 284, 293
Maximum sensitivity .....	122, 257
MB-D18 battery type.....	276
Memory buffer .....	115

Memory card .....	16, 93, 271, 360
Memory card capacity.....	362
Menu Guide .....	i
Metering.....	124
Microphone .....	1, 65, 67, 258, 297
Microphone sensitivity .....	65, 258
Minimum aperture .....	20, 127
Minimum shutter speed.....	122
Mired .....	162
Mirror.....	114, 118, 315
Mirror up mode .....	114, 118
Modeling flash .....	127, 267
Monitor.....	10, 12, 37, 223, 264, 271, 272
Monitor brightness .....	45, 66, 271
Monitor color balance.....	272
Monitor off delay .....	264
Monochrome.....	175, 279
Mounting mark.....	19, 351
Movie file type .....	257
Movie mode.....	59, 256, 270
Movie quality.....	69, 257
Movie shooting menu.....	256
Movie-record button .....	61, 268
Multi selector.....	25, 268, 269
Multi selector center button.....	268
Multi selector exposure comp. ....	66
Multiple exposure.....	254
Multi-power battery pack... ..	270, 276, 296, 299
Multi-selector power aperture.....	66
My Menu .....	280

## N

Natural light auto (White balance)....	156
NEF (RAW).....	88, 90, 92, 278
NEF (RAW) bit depth .....	90
NEF (RAW) compression.....	90
NEF (RAW) processing.....	278
NEF (RAW) recording .....	90, 252
Negative digitizer .....	52

Network.....	275
Neutral (Set Picture Control).....	175
Non-CPU lens.....	218, 282, 284
Non-CPU lens data.....	218, 219, 272
Normal-area AF.....	42
Number of focus points.....	261

## O

Optical VR .....	266
Overflow (Secondary slot function) ..	93
Overview data .....	237

## P

Peaking highlight color .....	265
Peaking level.....	47, 67
Perspective control .....	279
Photo information .....	229, 248
Photo live view display WB.....	46
Photo shooting menu .....	250
Photo shooting menu bank .....	250
PictBridge.....	349
Picture Controls .....	175
Pinpoint AF.....	42
Playback .....	35, 76, 223
Playback display options.....	248
Playback folder .....	248
Playback information.....	229, 248
Playback menu.....	248
Playback zoom .....	238
Portrait (Set Picture Control).....	175
Power aperture .....	66
Power connector.....	296
Predictive focus tracking.....	99
Preset manual (White balance) ..	157, 165
Press the shutter-release button halfway.....	33
Primary slot selection .....	93, 250
Programmed auto .....	128
Protecting photographs.....	240

Pv button.....	44, 127, 267, 268, 270
----------------	------------------------

## Q

Quiet continuous shutter-release .....	113
Quiet shutter-release .....	113

## R

Rank items (My Menu) .....	280
Rating.....	241
RAW primary - JPEG secondary (Secondary slot function).....	93
Rear-curtain sync .....	192
Recent settings .....	280
Rechargeable Li-ion battery ii, 14, 30, 347	
Red-eye correction.....	278
Red-eye reduction .....	192
Release button to use dial .....	269
Release mode.....	113
Remote cord.....	75, 133, 297
Remove items (My Menu).....	280
Removing the lens from the camera. 20	
Repeating flash.....	191, 199
Reset.....	209, 256, 277
Reset all settings .....	277
Reset movie shooting menu .....	256
Resize .....	278
Restoring default settings ..	209, 256, 277
Retouch menu .....	278
Reverse indicators .....	269
RGB .....	88, 232, 253
RGB Histogram .....	232
Rotate tall .....	249

## S

S (small).....	74, 91
Save current frame.....	78, 82
Save/load settings.....	277

SD memory card .....	16, 93, 361
Secondary slot function.....	93, 250
Select to send to smart device ....	249
Self-timer.....	113, 116, 264
Send to smart device (auto) .....	275
Sensitivity.....	119, 121, 252, 257
Set clock from satellite .....	221
Set Picture Control.....	175, 252, 257
Setup menu.....	271
Shade (White balance) .....	157
Shooting data.....	234
Shutter speed .....	129, 131, 136
Shutter speed lock.....	136, 268
Shutter-priority auto .....	129
Shutter-release button..	33, 108, 137, 270
Shutter-release button AE-L.....	263
Side-by-side comparison.....	279
Silent live view photography	49, 255
Single frame .....	113
Single-point AF .....	100, 103
Single-servo AF .....	41, 98, 260
Size .....	74, 91, 278
Skylight .....	279
Slide show.....	249
Slot.....	93, 224, 256
Slot empty release lock .....	276
Slot selection .....	93, 224
Slow sync.....	192
Slow-motion movie.....	69, 70
Slow-motion playback .....	76
Smart device .....	222, 249, 275
Smoothing .....	184
Speedlights.....	187, 288
Split-screen display zoom .....	46, 48
Spot.....	124
Spot white balance.....	169
sRGB .....	253
Standard (Set Picture Control)....	175
Standard i-TTL fill-flash for digital SLR .....	189, 288
Standby timer .....	34, 221, 263
Storage folder .....	250
Store by orientation.....	261
Straighten.....	278
Sub-dial frame advance.....	269
Subject motion .....	260
Sub-selector..	106, 108, 137, 268, 270
Sync with smart device.....	271
Sync. release mode options.....	264
Synchronized release .....	264
<b>T</b>	
Ten-pin remote terminal..	2, 221, 297
Text entry.....	273
Thumbnail .....	223
TIFF (RGB).....	88, 92
Tilting monitor .....	10
Time .....	23, 271
Time zone .....	22, 271
Time zone and date .....	22, 271
Time-lapse movie .....	259
Timer .....	116
Toning (Set Picture Control) .....	179
Touch controls.....	12, 226, 274
Touch screen .....	12, 56, 226
Touch shutter .....	56
Trim.....	278
Trim movie .....	78, 279
Two-button reset .....	209
Type D lens.....	281, 284
Type E lens.....	281, 284
Type G lens.....	281, 284
<b>U</b>	
Uncompressed (NEF (RAW) compression).....	90
USB cable .....	ii
UTC.....	22, 222
<b>V</b>	
Vibration reduction	66, 259, 266, 355

Viewfinder .....	7, 9, 338
Viewfinder eyepiece .....	9, 116
Viewfinder focus.....	9, 296
Viewfinder grid display .....	265
Viewfinder mask display.....	85
ViewNX-i.....	ii
Vignette control .....	253
Virtual horizon.....	55, 72, 272
Vivid (Set Picture Control).....	175
Volume control .....	228

## **W**

---

Warm filter .....	279
WB.....	148, 156, 252, 257
WB bracketing (Auto bracketing set)	142, 148
White balance .....	148, 156, 252, 257
White balance bracketing....	142, 148
Wide-area AF .....	42
Wi-Fi .....	xx, 275
Wind noise reduction .....	66, 259
Wireless remote (WR) options.....	274
Wireless remote controller ...	75, 274, 296
Wireless transmitter .....	296

## **X**

---

XQD card .....	16, 93, 360
----------------	-------------







## Warranty Terms - Nikon Europe Service Warranty

Dear Nikon Customer,

We thank you for your purchasing this Nikon product. Should your Nikon product require warranty service, please contact the dealer from whom it was purchased or a member of our authorized service network within the sales territory of Nikon Europe B.V. (e.g. Europe/Russia/others). See details under: <http://www.europe-nikon.com/support>

In order to avoid any unnecessary inconvenience, we advise you to read the user manuals carefully before contacting the dealer or our authorized service network.

Your Nikon equipment is guaranteed against any manufacturing defects for one full year from the date of original purchase. If during this period of guarantee the product proves defective due to improper material or workmanship, our authorized service network within the sales territory of Nikon Europe B.V. will, without charge for labor and parts, repair the product in the terms and conditions set as below. Nikon reserves the right (at its sole discretion) to replace or repair the product.

1. This warranty is only provided upon presentation of the completed warranty card and original invoice or purchase receipt indicating the date of purchase, product type and dealer's name, together with the product. Nikon reserves the right to refuse free-of-charge warranty service if the above documents cannot be presented or if the information contained in it is incomplete or illegible.

2. This warranty will not cover:

- necessary maintenance and repair or replacement of parts due to normal wear and tear.
- modifications to upgrade the product from its normal purpose as described in user manuals, without the prior written consent of Nikon.
- transport costs and all risks of transport relating directly or indirectly to the warranty of the products.
- any damage resulting from modifications or adjustments which may be made to the product, without the prior written consent of Nikon, in order to comply with local or national technical standards in force in any other country than the ones for which the product was originally designed and/or manufactured.

3. The warranty will not be applicable in the case of:

- damage caused by misuse including but not limited to failure to use the product for its normal purpose or according to the user instructions on the proper use and maintenance, and to installation or use of the product inconsistent with the safety standards in force in the country where it is used.
- damage caused by accidents including but not limited to lightning, water, fire, misuse or neglect.
- defacing, illegibility or removal of the model or serial number on the product.
- damage resulting from repairs or adjustments which have been conducted by unauthorized service organizations or persons.
- defects in any system into which the product is incorporated or with which it is used.

4. This service warranty does not affect the consumer's statutory rights under applicable national laws in force, nor the consumer's right against the dealer arising from their sales/purchase contract.

**Notice:** An overview of all authorized Nikon Service Stations can be found online by following this Link  
(URL = <http://www.europe-nikon.com/service/>).



# Nikon Europe Service Warranty Card

Model name

Nikon D850

Serial No.

Purchase date

■ Name and address of customer

■ Dealer

■ Distributor

Nikon Europe B.V.  
Tripolis 100, Burgerweeshuispad 101,  
1076 ER Amsterdam, The Netherlands

■ Manufacturer

NIKON CORPORATION  
Shinagawa Intercity Tower C, 2-15-3, Konan,  
Minato-ku, Tokyo 108-6290 Japan

No reproduction in any form of this manual, in whole or in part (except for brief quotation in critical articles or reviews), may be made without written authorization from NIKON CORPORATION.

**NIKON CORPORATION**

© 2017 Nikon Corporation

AMA16767

Printed in Europe



SB7K02(11)  
6MB40411-02