

Nikon

DIGITAL CAMERA

D750

User's Manual



Nikon Manual Viewer 2

Use the Nikon Manual Viewer 2 app to view manuals anytime, anywhere on your smartphone or tablet.

En

D750

Model Name: N1404

To get the most from your camera, please be sure to read all instructions thoroughly and keep them where they will be read by all who use the product.

Symbols and Conventions

To make it easier to find the information you need, the following symbols and conventions are used:



This icon marks cautions; information that should be read before use to prevent damage to the camera.



This icon marks notes; information that should be read before using the camera.



This icon marks references to other pages in this manual.

Menu items, options, and messages displayed in the camera monitor are shown in **bold**.

Camera Settings

The explanations in this manual assume that default settings are used.

Nikon Manual Viewer 2



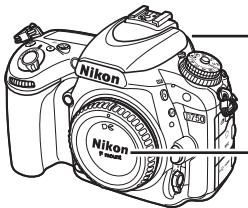
Install the Nikon Manual Viewer 2 app on your smartphone or tablet to view Nikon digital camera manuals, anytime, anywhere. Nikon Manual Viewer 2 can be downloaded free of charge from the App Store and Google Play. Download of the app and any product manuals requires an Internet connection, for which fees may be levied by your phone or Internet service provider.

For Your Safety

Before using the camera for the first time, read the safety instructions in "For Your Safety" (📖 xiii–xvi).

Package Contents

Be sure all items listed here were included with your camera.

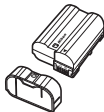


- DK-21 rubber eyecup (107)



- BF-1B body cap (27, 442)

- D750 camera (1)



- EN-EL15 rechargeable Li-ion battery with terminal cover (25, 26)



- MH-25a battery charger (comes with either an AC wall adapter or power cable of a type and shape that varies with the country or region of sale; 25)



- DK-5 eyepiece cap (107)

- UC-E17 USB cable (266, 271)

- User's Manual (this guide)






- AN-DC14 strap (24)













- ViewNX 2 installer CD (262)

- Warranty








Memory cards are sold separately. Cameras purchased in Japan display menus and messages in English and Japanese only; other languages are not supported. We apologize for any inconvenience this may cause.

Table of Contents

Package Contents	i
For Your Safety	xiii
Notices	xvii
Wireless	xxiv
Introduction	1
<hr/>	
Getting to Know the Camera	1
The Camera Body	1
The Mode Dial	6
The Release-Mode Dial	7
The Control Panel	8
The Viewfinder	10
The Information Display	12
The i button	16
Using the Tilting Monitor	17
The Multi Selector	19
Camera Menus	20
Using Camera Menus	21
First Steps	24
Basic Photography and Playback	34
<hr/>	
“Point-and-Shoot” Photography (AUTO and  Modes)	34
Basic Playback	37
Deleting Unwanted Photographs	38
Matching Settings to the Subject or Situation (Scene Mode)	41
<hr/>	
 Portrait	42
 Landscape	42
 Child	42
 Sports	42

 Close Up.....	43
 Night Portrait	43
 Night Landscape	43
 Party/Indoor	43
 Beach/Snow.....	44
 Sunset	44
 Dusk/Dawn	44
 Pet Portrait	44
 Candlelight	45
 Blossom	45
 Autumn Colors.....	45
 Food	45

Special Effects **46**

 Night Vision	47
 Color Sketch.....	47
 Miniature Effect	48
 Selective Color.....	48
 Silhouette	48
 High Key	49
 Low Key	49
Options Available in Live View	50

Live View Photography **54**

Focus	57
Manual Focus	60
Using the i Button	61
The Live View Display: Live View Photography	63
The Information Display: Live View Photography	64

Movie Live View **66**




Indices.....	70
Using the i Button	71
The Live View Display: Movie Live View	74

The Information Display: Movie Live View	75
Image Area.....	76
Taking Photos During Movie Live View	77
Viewing Movies.....	79
Editing Movies	81
Trimming Movies	81
Saving Selected Frames	86
P, S, A, and M Modes	88
<hr/>	
P: Programmed Auto.....	89
S: Shutter-Priority Auto.....	90
A: Aperture-Priority Auto	91
M: Manual	93
Long Time-Exposures (M Mode Only)	95
User Settings: U1 and U2 Modes	99
<hr/>	
Saving User Settings	99
Recalling User Settings.....	101
Resetting User Settings.....	101
Release Mode	103
<hr/>	
Choosing a Release Mode.....	103
Self-Timer Mode (☺)	106
Mirror up Mode (M _{UP}).....	109
Image Recording Options	110
<hr/>	
Image Area.....	110
Image Quality and Size.....	115
Image Quality	115
Image Size.....	118
Using Two Memory Cards.....	119


Focus	120
<hr/>	
Autofocus	120
Autofocus Mode.....	121
AF-Area Mode	123
Focus Point Selection	127
Focus Lock.....	129
Manual Focus	132
ISO Sensitivity	134
<hr/>	
Auto ISO Sensitivity Control	136
Exposure	139
<hr/>	
Metering	139
Autoexposure Lock.....	141
Exposure Compensation	143
White Balance	145
<hr/>	
Fine-Tuning White Balance	149
Choosing a Color Temperature	152
Preset Manual	155
Viewfinder Photography.....	155
Live View (Spot White Balance)	159
Managing Presets	162
Image Enhancement	165
<hr/>	
Picture Controls	165
Selecting a Picture Control.....	165
Modifying Picture Controls	167
Creating Custom Picture Controls.....	170
Sharing Custom Picture Controls.....	173
Preserving Detail in Highlights and Shadows	175
Active D-Lighting.....	175
High Dynamic Range (HDR)	177

Flash Photography	180
Using the Built-in Flash	180
Auto Pop-up Modes	180
Manual Pop-up Modes	182
Flash Compensation	188
FV Lock	190
Remote Control Photography	193
Using an Optional ML-L3 Remote Control.....	193
Wireless Remote Controllers	197
WR-1 Wireless Remote Controllers	197
WR-R10/WR-T10 Wireless Remote Controllers.....	197
Other Shooting Options	198
Viewfinder Photography: The <i>i</i> Button	198
Two-Button Reset: Restoring Default Settings	199
Bracketing	202
Multiple Exposure	216
Interval Timer Photography	222
Time-Lapse Photography	229
Non-CPU Lenses.....	235
Location Data	239
More on Playback	241
Viewing Pictures	241
Full-Frame Playback	241
Thumbnail Playback.....	243
Calendar Playback.....	244
The <i>i</i> Button	245
Photo Information.....	246
Taking a Closer Look: Playback Zoom	255
Protecting Photographs from Deletion	257

Deleting Photographs	258
Full-Frame, Thumbnail, and Calendar Playback.....	258
The Playback Menu.....	260
Connections	262
<hr/>	
Installing ViewNX 2	262
Using ViewNX 2	266
Copy Pictures to the Computer.....	266
Ethernet and Wireless Networks.....	269
Printing Photographs	271
Connecting the Printer	271
Printing Pictures One at a Time.....	272
Printing Multiple Pictures	274
Creating a DPOF Print Order: Print Set.....	275
Viewing Photographs on TV	277
HDMI Options	278
Wi-Fi	281
<hr/>	
What Wi-Fi Can Do for You	281
Accessing the Camera	282
WPS (Android Only)	284
PIN Entry (Android Only).....	285
SSID (Android and iOS).....	286
Selecting Pictures for Upload	289
Selecting Individual Pictures for Upload.....	289
Selecting Multiple Pictures for Upload	291
Menu Guide	292
<hr/>	
Defaults	292
▶ The Playback Menu: Managing Images	300
Playback Menu Options	300
Playback Folder	300
Hide Image.....	301
Playback Display Options	302

Copy Image(s).....	303
Image Review	307
After Delete	307
Rotate Tall	308
Slide Show	308
 The Photo Shooting Menu:	
Photo Shooting Options	310
Photo Shooting Menu Options	310
Reset Photo Shooting Menu	311
Storage Folder	311
File Naming	313
Color Space	314
Vignette Control	315
Auto Distortion Control	316
Long Exposure NR (Long Exposure Noise Reduction)	317
High ISO NR	317
 The Movie Shooting Menu:	
Movie Shooting Options	318
Movie Shooting Menu Options	318
Reset Movie Shooting Menu	318
Destination	319
Frame Size/Frame Rate	319
Movie Quality	320
Microphone Sensitivity	320
Frequency Response	320
Wind Noise Reduction	321
White Balance	321
Set Picture Control	321
Movie ISO Sensitivity Settings	322
 Custom Settings: Fine-Tuning Camera Settings	323
Custom Settings	324
Reset Custom Settings	326

a: Autofocus	326
a1: AF-C Priority Selection	326
a2: AF-S Priority Selection.....	327
a3: Focus Tracking with Lock-On.....	328
a4: Focus Point Illumination	329
a5: AF Point Illumination.....	329
a6: Focus Point Wrap-Around	330
a7: Number of Focus Points.....	330
a8: Store Points by Orientation.....	331
a9: Built-in AF-assist Illuminator.....	332
b: Metering/Exposure	333
b1: ISO Sensitivity Step Value.....	333
b2: EV Steps for Exposure Cntrl	333
b3: Easy Exposure Compensation	334
b4: Matrix Metering	335
b5: Center-Weighted Area	335
b6: Fine-tune Optimal Exposure	336
c: Timers/AE Lock	336
c1: Shutter-Release Button AE-L.....	336
c2: Standby timer.....	336
c3: Self-Timer.....	337
c4: Monitor off Delay	337
c5: Remote on Duration (ML-L3)	337
d: Shooting/Display.....	338
d1: Beep	338
d2: Continuous Low-Speed	338
d3: Max. Continuous Release	339
d4: Exposure Delay Mode.....	339
d5: Flash Warning	339
d6: File Number Sequence.....	340
d7: Viewfinder Grid Display	341
d8: Easy ISO.....	341
d9: Information Display.....	341
d10: LCD Illumination	342

d11: MB-D16 Battery Type	343
d12: Battery Order.....	344
e: Bracketing/Flash.....	345
e1: Flash Sync Speed.....	345
e2: Flash Shutter Speed	346
e3: Flash Cntrl for Built-in Flash.....	347
e4: Exposure Comp. for Flash	353
e5: Modeling Flash.....	353
e6: Auto Bracketing Set.....	353
e7: Bracketing Order	354
f: Controls	354
f1: OK Button.....	354
f2: Assign Fn Button	356
f3: Assign Preview Button	361
f4: Assign AE-L/AF-L Button	361
f5: Customize Command Dials	363
f6: Release Button to Use Dial.....	365
f7: Slot Empty Release Lock.....	365
f8: Reverse Indicators.....	366
f9: Assign Movie Record Button.....	366
f10: Assign MB-D16  Button.....	367
f11: Assign Remote (WR) Fn Button.....	368
g: Movie.....	370
g1: Assign Fn Button.....	370
g2: Assign Preview Button	372
g3: Assign AE-L/AF-L Button	373
g4: Assign Shutter Button	373
Y The Setup Menu: Camera Setup.....	374
Setup Menu Options.....	374
Format Memory Card	375
Monitor Brightness.....	376
Monitor Color Balance.....	377
Image Dust Off Ref Photo	378
Flicker Reduction.....	380

Time Zone and Date	381
Language.....	381
Auto Image Rotation	382
Battery Info	383
Image Comment	384
Copyright Information.....	385
Save/Load Settings	386
Virtual Horizon.....	388
AF Fine-tune	389
Eye-Fi Upload	391
Conformity Marking	392
Firmware Version.....	392
4 The Retouch Menu: Creating Retouched Copies	393
Retouch Menu Options	393
Creating Retouched Copies	395
D-Lighting	397
Red-Eye Correction	398
Trim.....	399
Monochrome	400
Filter Effects	401
Color Balance	402
Image Overlay	403
NEF (RAW) Processing.....	406
Resize	408
Quick Retouch	411
Straighten.....	411
Distortion Control.....	412
Fisheye.....	413
Color Outline	413
Color Sketch	414
Perspective Control	415
Miniature Effect	416
Selective Color.....	417
Side-by-side Comparison	419

☰ My Menu / ☰ Recent Settings	421
Recent Settings	425
Technical Notes	426
<hr/>	
Compatible Lenses	426
Optional Flash Units (Speedlights)	433
The Nikon Creative Lighting System (CLS).....	433
Other Accessories	441
Attaching a Power Connector and AC Adapter	445
Caring for the Camera	447
Storage.....	447
Cleaning.....	447
The Low-Pass Filter	448
Caring for the Camera and Battery: Cautions	455
Available Settings.....	460
Exposure Program (Mode P)	462
Troubleshooting	463
Battery/Display.....	463
Shooting (All Modes)	464
Shooting (P, S, A, M)	467
Playback.....	468
Wi-Fi (Wireless Networks).....	469
Miscellaneous	469
Error Messages	470
Specifications	477
Approved Memory Cards	491
Memory Card Capacity	492
Battery Life.....	494
Lenses That May Block the Built-in Flash and AF-Assist Illuminator	496
Index	501

For Your Safety

To prevent damage to your Nikon product or injury to yourself or to others, read the following safety precautions in their entirety before using this equipment. Keep these safety instructions where all those who use the product will read them.

The consequences that could result from failure to observe the precautions listed in this section are indicated by the following symbol:



This icon marks warnings. To prevent possible injury, read all warnings before using this Nikon product.

■ ■ WARNINGS

Keep the sun out of the frame

Keep the sun well out of the frame when shooting backlit subjects. Sunlight focused into the camera when the sun is in or close to the frame could cause a fire.

Do not look at the sun through the viewfinder

Viewing the sun or other strong light source through the viewfinder could cause permanent visual impairment.

Using the viewfinder diopter adjustment control

When operating the viewfinder diopter adjustment control with your eye to the viewfinder, care should be taken not to put your finger in your eye accidentally.

Turn off immediately in the event of malfunction

Should you notice smoke or an unusual smell coming from the equipment or AC adapter (available separately), unplug the AC adapter and remove the battery immediately, taking care to avoid burns. Continued operation could result in injury. After removing the battery, take the equipment to a Nikon-authorized service center for inspection.

Do not use in the presence of flammable gas

Do not use electronic equipment in the presence of flammable gas, as this could result in explosion or fire.

Keep out of reach of children

Failure to observe this precaution could result in injury. In addition, note that small parts constitute a choking hazard. Should a child swallow any part of this equipment, consult a physician immediately.

⚠ Do not disassemble

Touching the product's internal parts could result in injury. In the event of malfunction, the product should be repaired only by a qualified technician. Should the product break open as the result of a fall or other accident, remove the battery and/or AC adapter and then take the product to a Nikon-authorized service center for inspection.

⚠ Do not place the strap around the neck of an infant or child

Placing the camera strap around the neck of an infant or child could result in strangulation.

⚠ Do not remain in contact with the camera, battery, or charger for extended periods while the devices are on or in use

Parts of the device become hot. Leaving the device in direct contact with the skin for extended periods may result in low-temperature burns.

⚠ Do not leave the product where it will be exposed to extremely high temperatures, such as in an enclosed automobile or in direct sunlight

Failure to observe this precaution could cause damage or fire.

⚠ Do not aim a flash at the operator of a motor vehicle

Failure to observe this precaution could result in accidents.

⚠ Observe caution when using the flash

- Using the camera with the flash in close contact with the skin or other objects could cause burns.
- Using the flash close to the subject's eyes could cause temporary visual impairment. The flash should be no less than one meter (3 ft 4 in.) from the subject. Particular care should be observed when photographing infants.

⚠ Avoid contact with liquid crystal

Should the monitor break, care should be taken to avoid injury due to broken glass and to prevent the liquid crystal from the monitor touching the skin or entering the eyes or mouth.

⚠ Do not carry tripods with a lens or camera attached

You could trip or accidentally strike others, resulting in injury.

⚠ Observe proper precautions when handling batteries

Batteries may leak or explode if improperly handled. Observe the following precautions when handling batteries for use in this product:

- Use only batteries approved for use in this equipment.
- Do not short or disassemble the battery.
- Be sure the product is off before replacing the battery. If you are using an AC adapter, be sure it is unplugged.
- Do not attempt to insert the battery upside down or backwards.
- Do not expose the battery to flame or to excessive heat.
- Do not immerse in or expose to water.
- Replace the terminal cover when transporting the battery. Do not transport or store the battery with metal objects such as necklaces or hairpins.
- Batteries are prone to leakage when fully discharged. To avoid damage to the product, be sure to remove the battery when no charge remains.

- When the battery is not in use, attach the terminal cover and store in a cool, dry place.
- The battery may be hot immediately after use or when the product has been used on battery power for an extended period. Before removing the battery turn the camera off and allow the battery to cool.
- Discontinue use immediately should you notice any changes in the battery, such as discoloration or deformation.

⚠ Observe proper precautions when handling the charger

- Keep dry. Failure to observe this precaution could result in injury or product malfunction due to fire or electric shock.
- Do not short the charger terminals. Failure to observe this precaution could result in overheating and damage to the charger.
- Dust on or near the metal parts of the plug should be removed with a dry cloth. Continued use could result in fire.

- Do not handle the power cable or go near the charger during thunderstorms. Failure to observe this precaution could result in electric shock.
- Do not damage, modify, or forcibly tug or bend the power cable. Do not place it under heavy objects or expose it to heat or flame. Should the insulation be damaged and the wires become exposed, take the power cable to a Nikon-authorized service representative for inspection. Failure to observe this precaution could result in fire or electric shock.
- Do not handle the plug or charger with wet hands. Failure to observe this precaution could result in injury or product malfunction due to fire or electric shock.
- Do not use with travel converters or adapters designed to convert from one voltage to another or with DC-to-AC inverters. Failure to observe this precaution could damage the product or cause overheating or fire.

 **Use appropriate cables**

When connecting cables to the input and output jacks, use only the cables provided or sold by Nikon for the purpose to maintain compliance with product regulations.

 **CD-ROMs**

CD-ROMs containing software or manuals should not be played back on audio CD equipment. Playing CD-ROMs on an audio CD player could cause hearing loss or damage the equipment.

 **Follow the directions of airline and hospital personnel**

This camera transmits radio frequencies that could interfere with medical equipment or aircraft navigation. Disable the wireless network feature and remove all wireless accessories from the camera before boarding an aircraft, and turn the camera off during take off and landing. In medical facilities, follow staff instructions regarding the use of wireless devices.

Notices

- No part of the manuals included with this product may be reproduced, transmitted, transcribed, stored in a retrieval system, or translated into any language in any form, by any means, without Nikon's prior written permission.
- Nikon reserves the right to change the specifications of the hardware and software described in these manuals at any time and without prior notice.
- Nikon will not be held liable for any damages resulting from the use of this product.
- While every effort has been made to ensure that the information in these manuals is accurate and complete, we would appreciate it were you to bring any errors or omissions to the attention of the Nikon representative in your area (address provided separately).

Notice for Customers in Canada

CAN ICES-3 B / NMB-3 B

Notices for Customers in Europe

CAUTION: RISK OF EXPLOSION IF BATTERY IS REPLACED BY AN INCORRECT TYPE. DISPOSE OF USED BATTERIES ACCORDING TO THE INSTRUCTIONS.

This symbol indicates that electrical and electronic equipment is to be collected separately.



The following apply only to users in European countries:

- This product is designated for separate collection at an appropriate collection point. Do not dispose of as household waste.
- Separate collection and recycling helps conserve natural resources and prevent negative consequences for human health and the environment that might result from incorrect disposal.
- For more information, contact the retailer or the local authorities in charge of waste management.

This symbol on the battery indicates that the battery is to be collected separately.



The following apply only to users in European countries:

- All batteries, whether marked with this symbol or not, are designated for separate collection at an appropriate collection point. Do not dispose of as household waste.
- For more information, contact the retailer or the local authorities in charge of waste management.

Notices for Customers in the U.S.A.

Power Cable

At voltages over AC 125 V (U.S.A. only): The power cable must be rated for the voltage in use, be at least AWG no. 18 gauge, and have SVG insulation or better with a NEMA 6P-15 plug rated for AC 250 V 15 A.

Federal Communications Commission (FCC) Radio Frequency Interference Statement

This equipment has been tested and found to comply with the limits for a Class B digital device, pursuant to Part 15 of the FCC rules. These limits are designed to provide reasonable protection against harmful interference in a residential installation. This equipment generates, uses, and can radiate radio frequency energy and, if not installed and used in accordance with the instructions, may cause harmful interference to radio

communications. However, there is no guarantee that interference will not occur in a particular installation. If this equipment does cause harmful interference to radio or television reception, which can be determined by turning the equipment off and on, the user is encouraged to try to correct the interference by one or more of the following measures:

- Reorient or relocate the receiving antenna.
- Increase the separation between the equipment and receiver.
- Connect the equipment into an outlet on a circuit different from that to which the receiver is connected.
- Consult the dealer or an experienced radio/television technician for help.



Nikon
D750

CAUTIONS

Modifications

The FCC requires the user be notified that any changes or modifications made to this device that are not expressly approved by Nikon Corporation may void the user's authority to operate the equipment.

Interface Cables

Use the interface cables sold or provided by Nikon for your equipment. Using other interface cables may exceed the limits of Class B Part 15 of the FCC rules.

Notice for Customers in the State of California

WARNING: Handling the cord on this product may expose you to lead, a chemical known to the State of California to cause birth defects or other reproductive harm. *Wash hands after handling.*

Nikon Inc., 1300 Walt Whitman Road,
Melville, New York 11747-3064, U.S.A.
Tel.: 631-547-4200

Notice Concerning Prohibition of Copying or Reproduction

Note that simply being in possession of material that has been digitally copied or reproduced by means of a scanner, digital camera, or other device may be punishable by law.

- **Items prohibited by law from being copied or reproduced**

Do not copy or reproduce paper money, coins, securities, government bonds, or local government bonds, even if such copies or reproductions are stamped "Sample."

The copying or reproduction of paper money, coins, or securities which are circulated in a foreign country is prohibited.

Unless the prior permission of the government has been obtained, the copying or reproduction of unused postage stamps or post cards issued by the government is prohibited.

The copying or reproduction of stamps issued by the government and of certified documents stipulated by law is prohibited.

- **Cautions on certain copies and reproductions**

The government has issued cautions on copies or reproductions of securities issued by private companies (shares, bills, checks, gift certificates, etc.), commuter passes, or coupon tickets, except when a minimum of necessary copies are to be provided for business use by a company. Also, do not copy or reproduce passports issued by the government, licenses issued by public agencies and private groups, ID cards, and tickets, such as passes and meal coupons.

- **Comply with copyright notices**

The copying or reproduction of copyrighted creative works such as books, music, paintings, woodcuts, prints, maps, drawings, movies, and photographs is governed by national and international copyright laws. Do not use this product for the purpose of making illegal copies or to infringe copyright laws.

Disposing of Data Storage Devices

Please note that deleting images or formatting memory cards or other data storage devices does not completely erase the original image data. Deleted files can sometimes be recovered from discarded storage devices using commercially available software, potentially resulting in the malicious use of personal image data. Ensuring the privacy of such data is the user's responsibility.

Before discarding a data storage device or transferring ownership to another person, erase all data using commercial deletion software, or format the device and then completely refill it with images containing no private information (for example, pictures of empty sky). Be sure to also replace any pictures selected for preset manual (□ 162). Before discarding the camera or transferring ownership to another person, you should also use the **Wi-Fi > Network settings > Reset network settings** (□ 288) and **Network > Network settings** options in the camera setup menu to delete any personal network information. For more information on the **Network** menu, see the documentation provided with the optional communication unit. Care should be taken to avoid injury when physically destroying data storage devices.

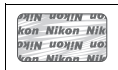
AVC Patent Portfolio License

THIS PRODUCT IS LICENSED UNDER THE AVC PATENT PORTFOLIO LICENSE FOR THE PERSONAL AND NON-COMMERCIAL USE OF A CONSUMER TO (i) ENCODE VIDEO IN COMPLIANCE WITH THE AVC STANDARD ("AVC VIDEO") AND/OR (ii) DECODE AVC VIDEO THAT WAS ENCODED BY A CONSUMER ENGAGED IN A PERSONAL AND NON-COMMERCIAL ACTIVITY AND/OR WAS OBTAINED FROM A VIDEO PROVIDER LICENSED TO PROVIDE AVC VIDEO. NO LICENSE IS GRANTED OR SHALL BE IMPLIED FOR ANY OTHER USE. ADDITIONAL INFORMATION MAY BE OBTAINED FROM MPEG LA, L.L.C. SEE <http://www.mpegla.com>

Use Only Nikon Brand Electronic Accessories

Nikon cameras are designed to the highest standards and include complex electronic circuitry. Only Nikon brand electronic accessories (including chargers, batteries, AC adapters, and flash accessories) certified by Nikon specifically for use with this Nikon digital camera are engineered and proven to operate within the operational and safety requirements of this electronic circuitry.

The use of non-Nikon electronic accessories could damage the camera and may void your Nikon warranty. The use of third-party rechargeable Li-ion batteries not bearing the Nikon holographic seal shown at right could interfere with normal operation of the camera or result in the batteries overheating, igniting, rupturing, or leaking.



For more information about Nikon brand accessories, contact a local authorized Nikon dealer.

✔ Use Only Nikon Brand Accessories

Only Nikon brand accessories certified by Nikon specifically for use with your Nikon digital camera are engineered and proven to operate within its operational and safety requirements. THE USE OF NON-NIKON ACCESSORIES COULD DAMAGE YOUR CAMERA AND MAY VOID YOUR NIKON WARRANTY.

✔ Before Taking Important Pictures

Before taking pictures on important occasions (such as at weddings or before taking the camera on a trip), take a test shot to ensure that the camera is functioning normally. Nikon will not be held liable for damages or lost profits that may result from product malfunction.

✔ Life-Long Learning

As part of Nikon's "Life-Long Learning" commitment to ongoing product support and education, continually-updated information is available on-line at the following sites:

- **For users in the U.S.A.:** <http://www.nikonusa.com/>
- **For users in Europe and Africa:** <http://www.europe-nikon.com/support/>
- **For users in Asia, Oceania, and the Middle East:** <http://www.nikon-asia.com/>

Visit these sites to keep up-to-date with the latest product information, tips, answers to frequently-asked questions (FAQs), and general advice on digital imaging and photography. Additional information may be available from the Nikon representative in your area. See the following URL for contact information: <http://imaging.nikon.com/>

Wireless

This product, which contains encryption software developed in the United States, is controlled by the United States Export Administration Regulations and may not be exported or re-exported to any country to which the United States embargoes goods. The following countries are currently subject to embargo: Cuba, Iran, North Korea, Sudan, and Syria.

The use of wireless devices may be prohibited in some countries or regions. Contact a Nikon-authorized service representative before using the wireless features of this product outside the country of purchase.

Notices for Customers in the U. S. A.

This device complies with Part 15 of the FCC Rules. Operation is subject to the following two conditions: (1) this device may not cause harmful interference, and (2) this device must accept any interference received, including interference that may cause undesired operation.

FCC WARNING

The FCC requires the user to be notified that any changes or modifications made to this device that are not expressly approved by Nikon Corporation may void the user's authority to operate the equipment.

FCC Radio Frequency Interference Statement

Note: This equipment has been tested and found to comply with the limits for a Class B digital device, pursuant to part 15 of the FCC Rules. These limits are designed to provide reasonable protection against harmful interference in a residential installation. This equipment generates, uses and can radiate radio frequency energy and, if not installed and used in accordance with the instructions, may cause harmful interference to radio communications. However, there is no guarantee that interference will not occur in a particular installation. If this equipment does cause harmful interference to radio or television reception, which can be determined by turning the equipment off and on, the user is encouraged to try to correct the interference by one or more of the following measures:

- Reorient or relocate the receiving antenna.
- Increase the separation between the equipment and receiver.
- Connect the equipment into an outlet on a circuit different from that to which the receiver is connected.
- Consult the dealer or an experienced radio/TV technician for help.

Co-location

This transmitter must not be co-located or operated in conjunction with any other antenna or transmitter.

Nikon Inc., 1300 Walt Whitman Road, Melville, New York 11747-3064, U.S.A.
Tel.: 631-547-4200

Notices for Customers in Canada

CAN ICES-3 B / NMB-3 B

This device complies with Industry Canada licence-exempt RSS standard(s). Operation is subject to the following two conditions: (1) this device may not cause interference, and (2) this device must accept any interference, including interference that may cause undesired operation of the device.

FCC/IC RF Exposure Statement

The available scientific evidence does not show that any health problems are associated with using low power wireless devices. There is no proof, however, that these low power wireless devices are absolutely safe. Low power Wireless devices emit low levels of radio frequency energy (RF) in the microwave range while being used. Whereas high levels of RF can produce health effects (by heating tissue), exposure of low-level RF that does not produce heating effects causes no known adverse health effects. Many studies of low-level RF exposures have not found any biological effects. Some studies have suggested that some biological effects might occur, but such findings have not been confirmed by additional research. The D750, which is equipped with a LBWA1U5YR1 (FCC ID:VPYLBYR650 / IC ID:772C-LBYR650) wireless LAN module, has been tested and found to comply with FCC/IC radiation exposure limits set forth for an uncontrolled environment and meets the FCC radio frequency (RF) Exposure Guidelines in Supplement C to OET65 and RSS-102 of the IC radio frequency (RF) Exposure rules. Please refer to the SAR test report that was uploaded to FCC website.

Notices for Customers in Europe

Hereby, Nikon Corporation, declares that the D750 is in compliance with the essential requirements and other relevant provisions of Directive 1999/5/EC. The declaration of conformity may be consulted at http://imaging.nikon.com/support/pdf/DoC_D750.pdf



Notice for Customers in Singapore

Trade Name: **Nikon**
Model: D750

This device complies with radio-frequency regulations. The content of certification labels not affixed to the device is given below.

Complies with
IDA Standards
DA104328

Security

Although one of the benefits of this product is that it allows others to freely connect for the wireless exchange of data anywhere within its range, the following may occur if security is not enabled:

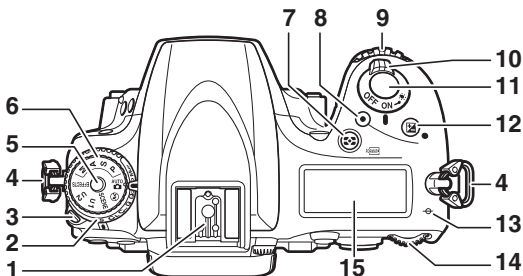
- **Data theft:** Malicious third-parties may intercept wireless transmissions to steal user IDs, passwords, and other personal information.
- **Unauthorized access:** Unauthorized users may gain access to the network and alter data or perform other malicious actions. Note that due to the design of wireless networks, specialized attacks may allow unauthorized access even when security is enabled.

Introduction

Getting to Know the Camera

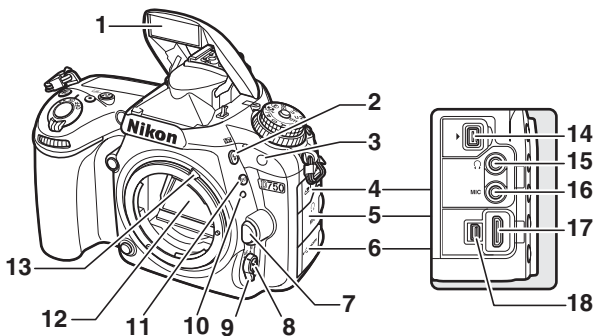
Take a few moments to familiarize yourself with camera controls and displays. You may find it helpful to bookmark this section and refer to it as you read through the rest of the manual.

The Camera Body



- | | | | | | |
|---|---|--------|----|---|---------|
| 1 | Accessory shoe (for optional flash unit)..... | 433 | 8 | Movie-record button | 68 |
| 2 | Release mode dial | 7, 103 | 9 | Sub-command dial | 363 |
| 3 | Release mode dial lock release | 7, 103 | 10 | Power switch | 5, 28 |
| 4 | Eyelet for camera strap | | 11 | Shutter-release button..... | 36, 373 |
| 5 | Mode dial lock release | 6, 34 | 12 | [A-] button
Exposure compensation | 143 |
| 6 | Mode dial | 6, 34 | | Two-button reset | 199 |
| 7 | [P/normal] button
Metering | 140 | 13 | Focal plane mark (⊖)..... | 133 |
| | Formatting memory cards ... | 375 | 14 | Main command dial..... | 363 |
| | | | 15 | Control panel | 8 |

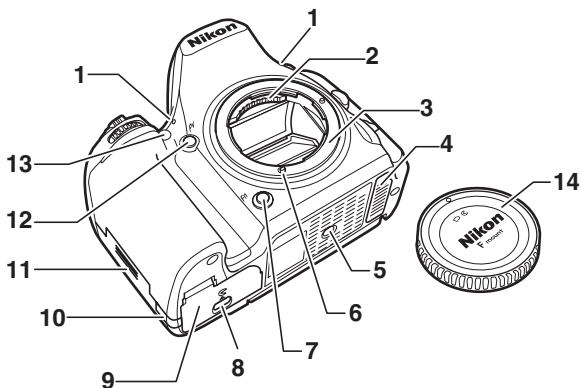
The Camera Body (Continued)



1 Built-in flash..... 180	11 BKT button
2 button	Bracketing..... 203, 208, 212
Flash mode..... 180, 182	12 Mirror..... 109, 451
Flash compensation 188	13 Meter coupling lever 480
3 Infrared receiver (front)..... 194	14 Accessory terminal..... 443
4 Cover for accessory terminal ... 443	15 Headphone connector.....73
5 Audio connector cover.....73, 443	16 Connector for external
6 HDMI/USB connector	microphone73, 443
cover 266, 271, 277	17 HDMI connector 277
7 Lens release button.....33	18 USB connector
8 AF-mode button...57, 59, 121, 125	Connecting to
9 Focus-mode selector ...57, 120, 132	a computer..... 266
10 Lens mounting mark27	Connecting to a printer 271

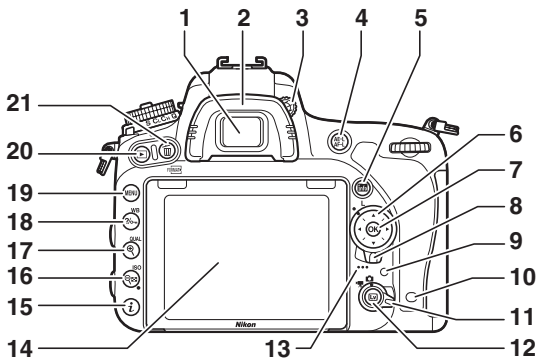
Close the Connector Cover

Close the connector cover when the connectors are not in use. Foreign matter in the connectors can interfere with data transfer.



1 Stereo microphone.....68, 71, 320	9 Battery-chamber cover 26
2 CPU contacts	10 Power connector cover 445
3 Lens mount 27, 133	11 Memory card slot cover 26
4 Contact cover for optional MB-D16 battery pack.....441	12 Pv button70, 92, 361, 372
5 Tripod socket	13 AF-assist illuminator 332
6 AF coupling	Self-timer lamp 107
7 Fn button..... 114, 356, 370	Red-eye reduction lamp... 181, 183
8 Battery-chamber cover latch 26	14 Body cap i, 442

The Camera Body (Continued)



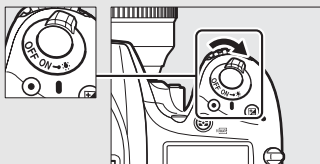
<p>1 Viewfinder eyepiece 10, 29</p> <p>2 Rubber eyecup 107</p> <p>3 Diopter adjustment control 29</p> <p>4 AE-L AF-L button Using the AE/AF lock button 129, 141, 361, 373</p> <p>5 info (info) button 12, 64, 75</p> <p>6 Multi selector 19, 21</p> <p>7 OK (OK) button 19, 21, 354</p> <p>8 Focus selector lock 127</p> <p>9 Memory card access lamp .. 36, 225</p> <p>10 Infrared receiver (rear) 194</p> <p>11 Live view selector Live view photography 54 Movie live view 66</p> <p>12 Lv button 54, 66</p> <p>13 Speaker 80</p>	<p>14 Tilting monitor 17 Viewing settings 12 Live view 54, 66 Viewing pictures 37 Full-frame playback 241</p> <p>15 z button Changing shooting settings 198 Changing settings during live view/movie recording ... 61, 71 Retouching pictures 396</p> <p>16 Q/ISO button Playback zoom out/ thumbnails 243, 244 ISO sensitivity 134 Auto ISO sensitivity control 136 Two-button reset 199</p>
---	--

<p>17 QUAL button</p> <p>Playback zoom in.....255</p> <p>Image quality/size 116, 118</p>	<p>19 MENU button</p> <p>Menu 20, 300</p>
<p>18 WB button</p> <p>Help..... 21</p> <p>Protect.....257</p> <p>White balance</p> <p>..... 146, 149, 154, 156</p>	<p>20 button</p> <p>Playback..... 37, 241</p> <p>21 button</p> <p>Delete 38, 258</p> <p>Formatting memory cards.... 375</p>

LCD Illuminators

Rotating the power switch toward activates the standby timer and control panel backlight (LCD illuminator), allowing the display to be read in the dark. After the power switch is released and returns to the **ON** position, the illuminators will remain lit for six seconds while the standby timer is active or until the shutter is released or the power switch is rotated toward again.

Power switch



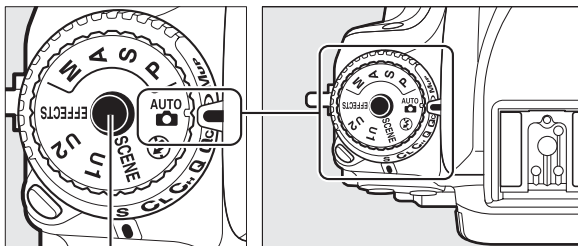
The Speaker

Do not place the speaker in close proximity to magnetic devices. Failure to observe this precaution could affect the data recorded on the magnetic devices.

The Mode Dial

The camera offers the modes listed below. To choose a mode, press the mode dial lock release and rotate the mode dial.

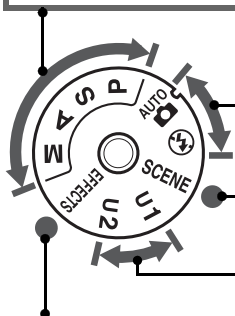
Mode dial



Mode dial lock release

P, S, A, and M modes:

- **P**—Programmed auto (89)
- **S**—Shutter-priority auto (90)
- **A**—Aperture-priority auto (91)
- **M**—Manual (93)



Auto modes:

-  Auto (34)
-  Auto (flash off) (34)

Scene modes (41)

U1 and U2 modes (99)

Special effects modes (46)

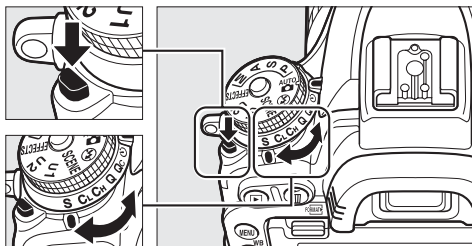
Non-CPU Lenses

Non-CPU (□ 427) lenses can be used only in modes **A** and **M**. Selecting another mode when a non-CPU lens is attached disables the shutter release.

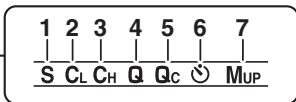
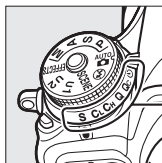
The Release-Mode Dial

To choose a release mode, press the release mode dial lock release and turn the release mode dial to the desired setting (□ 103).

Release mode dial lock release

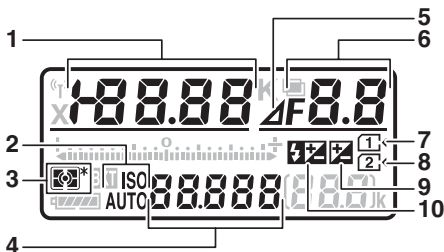


Release mode dial

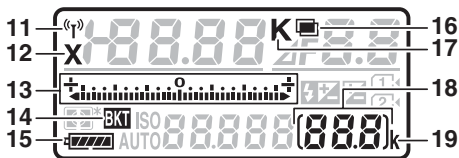


1	S Single frame	103	5	Qc Qc (quiet continuous) shutter-release	103
2	CL Continuous low speed	103	6	⌚ Self-timer	103, 106
3	CH Continuous high speed.....	103	7	MUP Mirror up	104, 109
4	Q Quiet shutter-release	103			

The Control Panel



<p>1 Shutter speed 90, 93</p> <p>Exposure compensation value 143</p> <p>Flash compensation value 188</p> <p>White balance fine-tuning 150</p> <p>Color temperature 145, 154</p> <p>White balance preset number 155</p> <p>Number of shots in exposure and flash bracketing sequence 203</p> <p>Number of shots in WB bracketing sequence 208</p> <p>Number of intervals for interval timer photography 225</p> <p>Focal length (non-CPU lenses) 238</p> <p>2 ISO sensitivity indicator 134</p> <p>Auto ISO sensitivity indicator 137</p> <p>3 Metering 140</p> <p>4 ISO sensitivity 134</p> <p>Autofocus mode 121</p>	<p>5 Aperture stop indicator 92, 431</p> <p>6 Aperture (f-number) 91, 93</p> <p>Aperture (number of stops) 92, 431</p> <p>Bracketing increment 204, 209</p> <p>Number of shots in ADL bracketing sequence 212</p> <p>Number of shots per interval 225</p> <p>Maximum aperture (non-CPU lenses) 238</p> <p>PC mode indicator 444</p> <p>7 Memory card indicator (Slot 1) 31, 376</p> <p>8 Memory card indicator (Slot 2) 31, 376</p> <p>9 Exposure compensation indicator 144</p> <p>10 Flash compensation indicator 189</p>
---	---

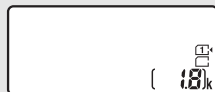


<p>11 Wi-Fi indicator 288</p> <p>12 Flash sync indicator 345</p> <p>13 Exposure/bracketing indicator Exposure 94 Exposure compensation 143 Exposure/flash bracketing... 203 White balance bracketing... 208 ADL bracketing..... 212</p> <p>14 Exposure/flash bracketing indicator..... 203 WB bracketing indicator 208 ADL bracketing indicator..... 212</p> <p>15 Battery indicator 30</p> <p>16 Multiple exposure indicator 217</p> <p>17 Color temperature indicator 152</p>	<p>18 Number of exposures remaining..... 31 Number of shots remaining before memory buffer fills 105, 492 AF-area mode indicator 126 Preset manual white balance recording indicator 157 Time-lapse recording indicator 233 Manual lens number..... 238 Capture mode indicator..... 444 HDMI-CEC connection indicator 280</p> <p>19 "k" (appears when memory remains for over 1000 exposures)..... 31</p>
---	---

Note: Display shown with all indicators lit for illustrative purposes.

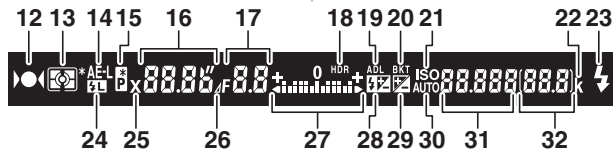
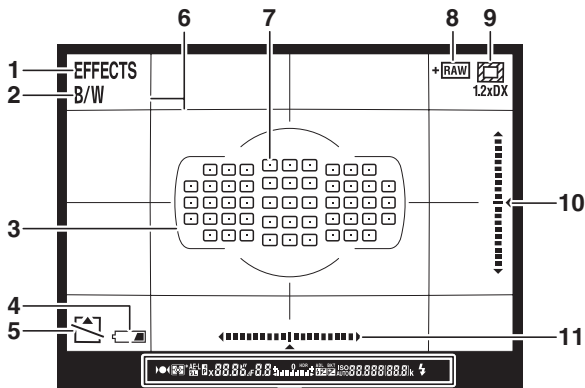
Camera Off Display

If the camera is turned off with a battery and memory card inserted, the memory card icon and number of exposures remaining will be displayed (some memory cards may in rare cases only display this information when the camera is on).



Control panel

The Viewfinder



- | | |
|--|---|
| <p>1 Special effects mode indicator46</p> <p>2 Monochrome indicator (displayed in mode or when the Monochrome Picture Control or a Picture Control based on Monochrome is selected)47, 165</p> <p>3 AF area brackets 29, 35, 247</p> <p>4 Low battery warning30</p> <p>5 "No memory card" indicator33</p> | <p>6 Framing grid (displayed when On is selected for Custom Setting d7, Viewfinder grid display)... 341</p> <p>7 Focus points.....36, 127, 329, 330
AF-area mode..... 126</p> <p>8 + NEF (RAW) indicator 357</p> <p>9 1.2× DX crop..... 111</p> <p>10 Roll indicator
(portrait orientation)..... 359</p> <p>11 Roll indicator
(landscape orientation) 359</p> |
|--|---|

12	Focus indicator	36, 129, 133	25	Flash sync indicator.....	345
13	Metering	139, 140	26	Aperture stop indicator.....	92, 431
14	Autoexposure (AE) lock.....	141	27	Exposure indicator	94
15	Flexible program indicator	89		Exposure compensation display	143
16	Shutter speed	90, 93	28	Flash compensation indicator	188
	Autofocus mode.....	120, 121	29	Exposure compensation indicator	144
17	Aperture (f-number)	91, 93	30	Auto ISO sensitivity indicator	137
	Aperture (number of stops)	92, 431	31	ISO sensitivity	134
18	HDR indicator.....	178		AF-area mode	123, 125
19	ADL indicator	176	32	Number of exposures remaining	31
20	Exposure/flash bracketing indicator.....	203		Number of shots remaining before memory buffer fills	105, 492
	WB bracketing indicator	208		Preset manual white balance recording indicator	157
	ADL bracketing indicator.....	212		Exposure compensation value	143
21	ISO sensitivity indicator.....	134		Flash compensation value.....	188
22	"k" (appears when memory remains for over 1000 exposures)	31			
23	Flash-ready indicator	40, 339			
24	FV lock indicator.....	191			

Note: Display shown with all indicators lit for illustrative purposes.

✓ No Battery

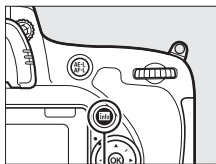
When the battery is totally exhausted or no battery is inserted, the display in the viewfinder will dim. This is normal and does not indicate a malfunction. The viewfinder display will return to normal when a fully-charged battery is inserted.

✓ The Control Panel and Viewfinder Displays

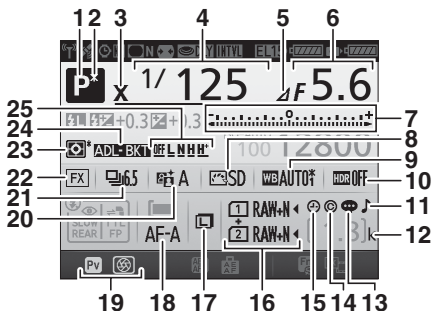
The brightness of the control panel and viewfinder displays varies with temperature, and the response times of the displays may drop at low temperatures. This is normal and does not indicate a malfunction.

The Information Display

Press the **Info** button to display shutter speed, aperture, the number of exposures remaining, AF-area mode, and other shooting information in the monitor.




Info button



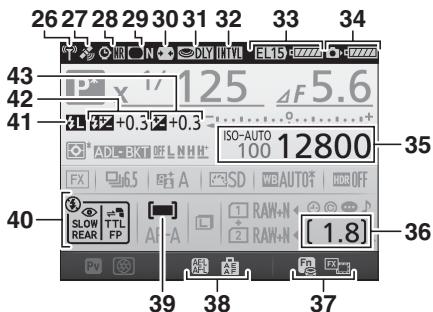
- | | |
|---|--|
| <p>1 Shooting mode 6, 34, 41, 46, 88</p> <p>2 Flexible program indicator 89</p> <p>3 Flash sync indicator 345</p> <p>4 Shutter speed 90, 93
Number of shots in exposure and
flash bracketing sequence 203
Number of shots in WB bracketing
sequence 208
Focal length (non-CPU
lenses) 235</p> | <p>5 Aperture stop indicator 92, 431</p> <p>6 Aperture (f-number) 91, 93
Aperture (number of
stops) 92, 431
Bracketing increment 204, 209
Number of shots in ADL
bracketing sequence 212
Maximum aperture (non-CPU
lenses) 238</p> |
|---|--|

7	Exposure indicator..... 94	14	Copyright information 385
	Exposure compensation display 143	15	“Clock not set” indicator 15, 381
	Bracketing progress indicator	16	Image quality 116
	Exposure and flash bracketing 203		Role played by card in slot 2 119
	WB bracketing 208	17	Image size..... 118
8	Picture Control indicator 166	18	Autofocus mode 121
9	White balance..... 146	19	Pv button assignment 361
	White balance fine-tuning indicator..... 150	20	Active D-Lighting indicator..... 176
10	HDR indicator..... 178	21	Release mode 7, 103
	HDR strength 178		Continuous shooting speed..... 338
	Multiple exposure indicator 219	22	Image area indicator..... 112
11	“Beep” indicator 338	23	Metering 139
12	“k” (appears when memory remains for over 1000 exposures) 31	24	Exposure and flash bracketing indicator 203
			WB bracketing indicator 208
			ADL bracketing indicator..... 212
13	Image comment indicator..... 384	25	ADL bracketing amount..... 213

Turning the Monitor Off

To clear shooting information from the monitor, press the  button again or press the shutter-release button halfway. The monitor will turn off automatically if no operations are performed for about 10 seconds.



The Information Display (Continued)





<p>26 Wi-Fi connection indicator 288 Eye-Fi connection indicator 392</p> <p>27 Satellite signal indicator 240</p> <p>28 Long exposure noise reduction indicator 317</p> <p>29 Vignette control indicator 315</p> <p>30 Auto distortion control 316</p> <p>31 Exposure delay mode 339</p> <p>32 Interval timer indicator 222 Time-lapse indicator 229 Remote control mode (ML-L3) 193</p> <p>33 MB-D16 battery type display... 344 MB-D16 battery indicator 343</p> <p>34 Camera battery indicator 30</p> <p>35 ISO sensitivity indicator 134 ISO sensitivity 134 Auto ISO sensitivity indicator 137</p>	<p>36 Number of exposures remaining 31 Time-lapse recording indicator 233</p> <p>37 Fn button assignment 356</p> <p>38 AE-L/AF-L button assignment ... 361</p> <p>39 AF-area mode indicator 126</p> <p>40 Flash mode 180, 182</p> <p>41 FV lock indicator 191</p> <p>42 Flash compensation indicator 188 Flash compensation value 188</p> <p>43 Exposure compensation indicator 144 Exposure compensation value 143</p>
---	---

Note: Display shown with all indicators lit for illustrative purposes.

See Also

For information on choosing how long the monitor stays on, see Custom Setting c4 (**Monitor off delay**,  337). For information on changing the color of the lettering in the information display, see Custom Setting d9 (**Information display**,  341).

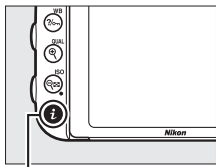
The ☹ (“Clock Not Set”) Icon

The camera clock is powered by an independent, rechargeable power source, which is charged as necessary when the main battery is installed or the camera is powered by an optional power connector and AC adapter ( 441). Two days of charging will power the clock for about three months. If the camera displays a warning stating that the clock is reset and a ☹ icon flashes in the information display, the clock has been reset and the date and time recorded with new photographs will not be correct. Use the **Time zone and date > Date and time** option in the setup menu to set the clock to the correct time and date ( 28, 381).

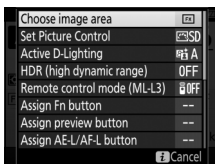
The camera clock is less accurate than most watches and household clocks. Check the clock regularly against more accurate time pieces and reset as necessary.

The *i* button

Use the *i* button for quick access to frequently-used settings in playback mode (📖 245) and during viewfinder (📖 198) and live view photography (📖 61) and movie live view (📖 71).



i button



Viewfinder photography



Playback



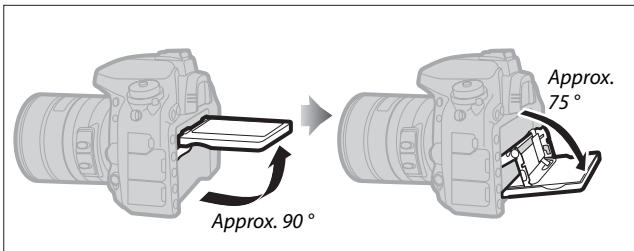
Live view photography



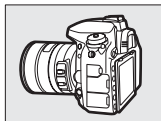
Movie live view

Using the Tilting Monitor

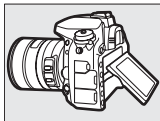
The monitor can be angled and rotated as shown below.



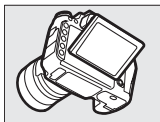
Normal use: The monitor is normally used in storage position.



Low-angle shots: Take shots with the camera held low.



High-angle shots: Take shots with the camera held high.

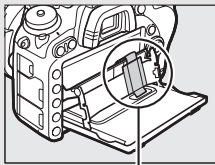


✔ Using the Monitor

Rotate the monitor gently within the limits shown on page 17. *Do not use force.* Failure to observe these precautions could damage the camera or monitor. If the camera is mounted on a tripod, care should be taken to ensure that the monitor does not contact the tripod.





Do not lift or carry the camera by the monitor. Failure to observe this precaution could damage the camera. If the monitor is not being used to take photographs, return it to the storage position.

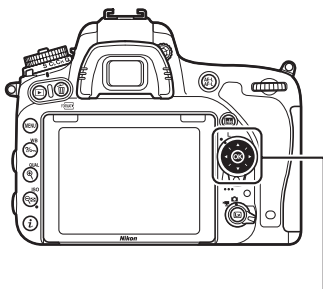
Do not touch the area to the rear of the monitor or allow liquid to contact the inner surface. Failure to observe these precautions could cause product malfunction.




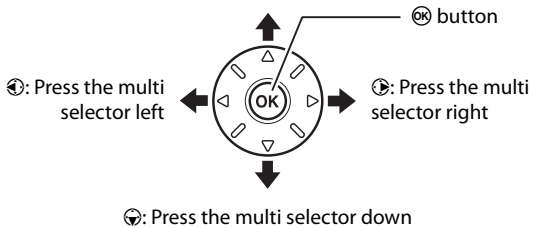
Be particularly careful not to touch this area.

The Multi Selector

In this manual, operations using the multi selector are represented by , , , and  icons.

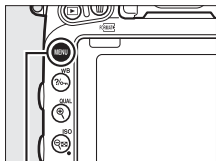


: Press the multi selector up



Camera Menu

Most shooting, playback, and setup options can be accessed from the camera menu. To view the menus, press the **MENU** button.

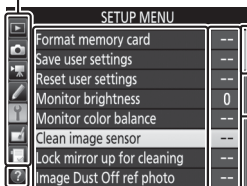


MENU button

Tabs

Choose from the following menus:

- ▶: **Playback** (📖 300)
- 📷: **Photo Shooting** (📖 310)
- 🎬: **Movie Shooting** (📖 318)
- 🔧: **Custom Settings** (📖 323)
- ⚙️: **Setup** (📖 374)
- 🖨️: **Retouch** (📖 393)
- 📄/📄: **MY MENU** or **RECENT SETTINGS** (defaults to **MY MENU**; 📖 421)



Slider shows position in current menu.

Current settings are shown by icons.

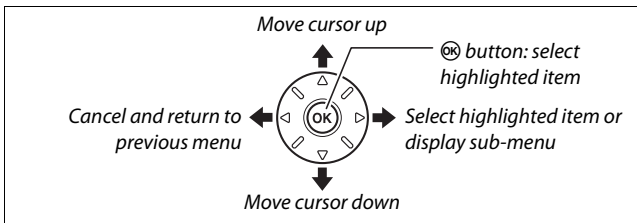
Menu options
Options in current menu.

Help icon (📖 21)

Using Camera Menus

■ Menu Controls

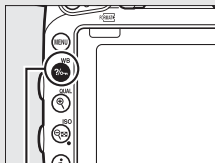
The multi selector and **OK** button are used to navigate the camera menus.



■ The ? (Help) Icon

If a ? icon is displayed at the bottom left corner of the monitor, help can be displayed by pressing the **?/WB** button.

A description of the currently selected option or menu will be displayed while the button is pressed. Press \updownarrow to scroll through the display.



?/WB button

? Multiple exposure

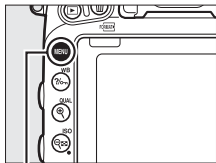
Record the specified number of shots as a single image. The standby timer is extended by 30 s. If the timer expires, shooting will end and a multiple exposure will be created from any shots that have been taken.

■ Navigating the Menus

Follow the steps below to navigate the menus.


1 Display the menus.

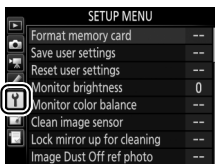
Press the **MENU** button to display the menus.



MENU button

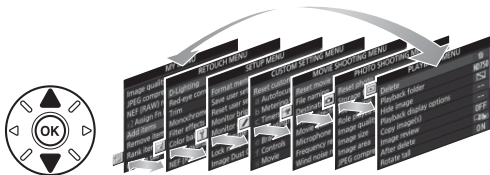
2 Highlight the icon for the current menu.

Press  to highlight the icon for the current menu.




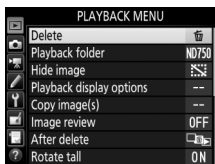
3 Select a menu.

Press  or  to select the desired menu.





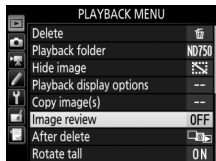
4 Position the cursor in the selected menu.

Press  to position the cursor in the selected menu.




5 Highlight a menu item.

Press  or  to highlight a menu item.





6 Display options.

Press  to display options for the selected menu item.




7 Highlight an option.

Press  or  to highlight an option.






8 Select the highlighted item.

Press  to select the highlighted item. To exit without making a selection, press the **MENU** button.



Note the following:

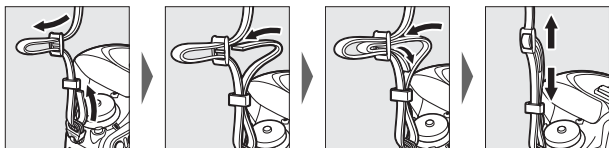
- Menu items that are displayed in gray are not currently available.
- While pressing  generally has the same effect as pressing , there are some cases in which selection can only be made by pressing .
- To exit the menus and return to shooting mode, press the shutter-release button halfway.

First Steps

Follow the seven steps below to ready the camera for use.

1 Attach the strap.

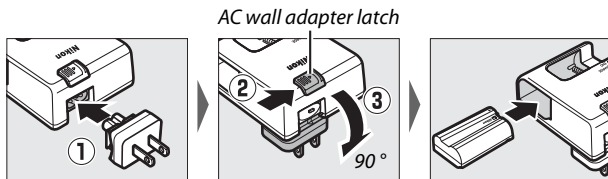
Attach the strap as shown. Repeat for the second eyelet.



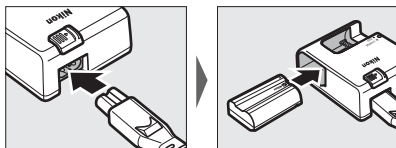
2 Charge the battery.

Insert the battery and plug the charger in (depending on the country or region, the charger comes with either an AC wall adapter or a power cable). An exhausted battery will fully charge in about two hours and 35 minutes.

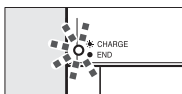
- **AC wall adapter:** Insert the AC wall adapter into the charger AC inlet (①). Slide the AC wall adapter latch as shown (②) and rotate the adapter 90° to fix it in place (③). Insert the battery and plug the charger in.



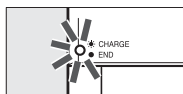
- **Power cable:** After connecting the power cable with the plug in the orientation shown, insert the battery and plug the cable in.



The **CHARGE** lamp will flash while the battery charges.



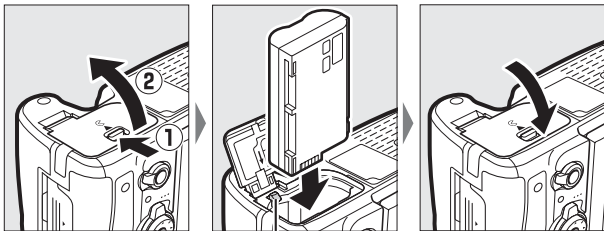
Battery charging



Charging complete

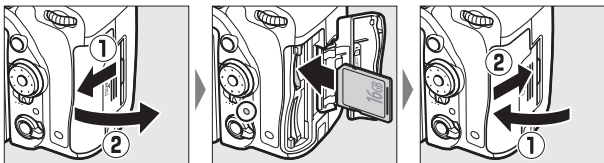
3 Insert the battery and memory card.

Before inserting or removing the battery or memory cards, confirm that power switch is in the **OFF** position. Insert the battery in the orientation shown, using the battery to keep the orange battery latch pressed to one side. The latch locks the battery in place when the battery is fully inserted.



Battery latch

If you are using only one memory card, insert it into slot 1 (31). Slide the memory card in until it clicks into place.

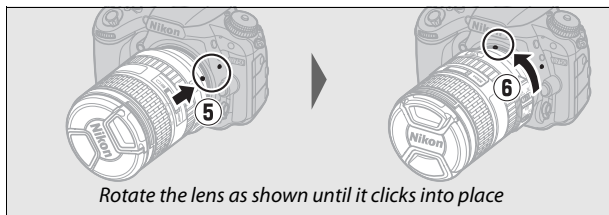
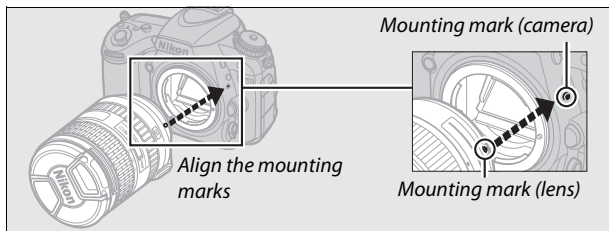
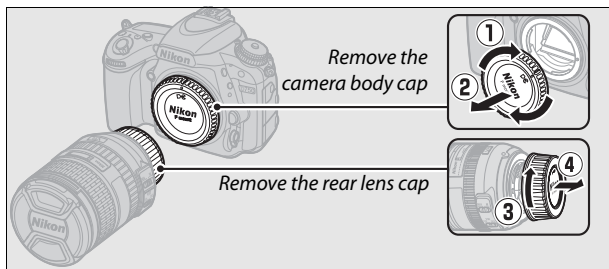


The Battery and Charger

Read and follow the warnings and cautions on pages xiii–xvi and 457–459 of this manual.

4 Attach a lens.

Be careful to prevent dust from entering the camera when the lens or body cap is removed. The lens generally used in this manual for illustrative purposes is an AF-S NIKKOR 24–85mm f/3.5–4.5G ED VR.

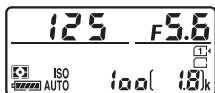
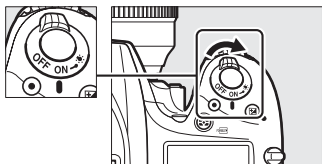


Be sure to remove the lens cap before taking pictures.

5 Turn the camera on.

The control panel will light. If this is the first time the camera has been turned on, a language-selection dialog will be displayed.

Power switch



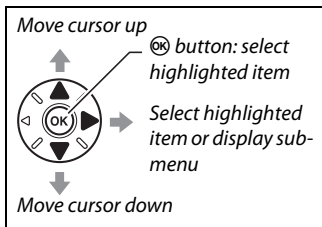
Control panel

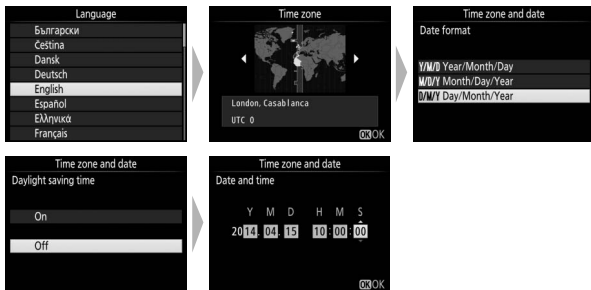
Image Sensor Cleaning

The camera vibrates the low-pass filter covering the image sensor to remove dust when the camera is turned on or off (448).

6 Choose a language and set the camera clock.

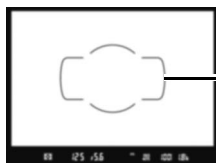
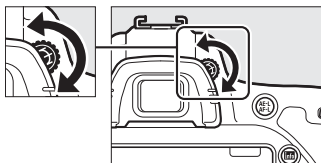
Use the multi selector and **OK** button to select a language and set the camera clock. When setting the camera clock, you will be prompted to choose a time zone, date format, and daylight saving time option before setting the time and date; note that the camera uses a 24-hour clock. Language and date/time settings can be changed at any time using the **Language** (381) and **Time zone and date** (381) options in the setup menu.





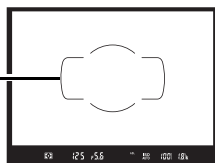
7 Focus the viewfinder.

Rotate the diopter adjustment control until the AF area brackets are in sharp focus. When operating the control with your eye to the viewfinder, be careful not to put your fingers or fingernails in your eye.



Viewfinder not in focus

AF area brackets

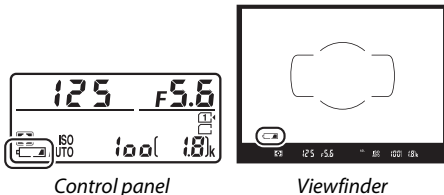


Viewfinder in focus

The camera is now ready for use. Proceed to page 34 for information on taking photographs.

■ Battery Level

The battery level is shown in the control panel and viewfinder.



Control panel

Viewfinder

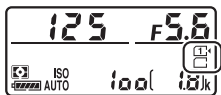
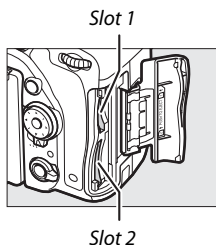
Control panel	Viewfinder	Description
	—	Battery fully charged.
	—	Battery partially discharged.
	—	
	—	
		Low battery. Charge battery or ready spare battery.
 (flashes)	 (flashes)	Shutter release disabled. Charge or exchange battery.

■ ■ Number of Exposures Remaining

The camera has two memory card slots: slot 1 and slot 2. Slot 1 is for the main card; the card in slot 2 plays a backup or secondary role. If the default setting of **Overflow** is selected for **Role played by card in Slot 2** (📖 119) when two memory cards are inserted, the card in slot 2 will only be used when the card in slot 1 is full.

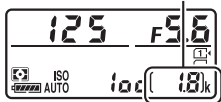
The control panel shows the slot or slots that currently hold a memory card (the example at right shows the icons displayed when a card is inserted in each slot). If the memory card is full or locked or an error has occurred, the icon for the affected card will flash (📖 473).

The control panel and viewfinder show the number of photographs that can be taken at current settings (values over 1000 are rounded down to the nearest hundred; e.g., values between 1800 and 1899 are shown as 1.8 k). If two memory cards are inserted, the displays show the space available on the card in Slot 1.



Control panel

Number of exposures remaining



Control panel

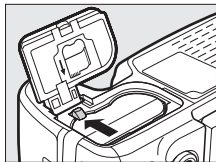


Viewfinder

■ Removing the Battery and Memory Cards

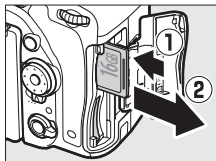
Removing the Battery

Turn the camera off and open the battery-chamber cover. Press the battery latch in the direction shown by the arrow to release the battery and then remove the battery by hand.



Removing Memory Cards

After confirming that the memory card access lamp is off, turn the camera off, open the memory card slot cover, and press the card in and then release it (1). The card can then be removed by hand (2).

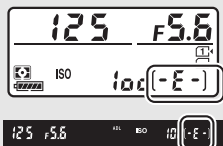


✓ Memory Cards

- Memory cards may be hot after use. Observe due caution when removing memory cards from the camera.
- Turn the power off before inserting or removing memory cards. Do not remove memory cards from the camera, turn the camera off, or remove or disconnect the power source during formatting or while data are being recorded, deleted, or copied to a computer. Failure to observe these precautions could result in loss of data or in damage to the camera or card.
- Do not touch the card terminals with your fingers or metal objects.
- Do not bend, drop, or subject to strong physical shocks.
- Do not apply force to the card casing. Failure to observe this precaution could damage the card.
- Do not expose to water, heat, high levels of humidity, or direct sunlight.
- Do not format memory cards in a computer.

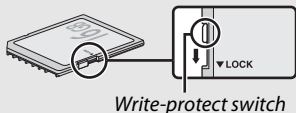
❏ No Memory Card

If no memory card is inserted, the control panel and viewfinder will show [- E -]. If the camera is turned off with a charged battery and no memory card inserted, [- E -] will be displayed in the control panel.



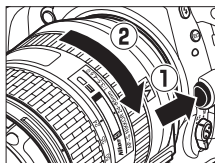
❏ The Write Protect Switch

SD memory cards are equipped with a write protect switch to prevent accidental loss of data. When this switch is in the “lock” position, the memory card can not be formatted and photos can not be deleted or recorded (a warning will be displayed in the monitor if you attempt to release the shutter). To unlock the memory card, slide the switch to the “write” position.



■ Detaching the Lens

Be sure the camera is off when removing or exchanging lenses. To remove the lens, press and hold the lens release button (1) while turning the lens clockwise (2). After removing the lens, replace the lens caps and camera body cap.







❏ CPU Lenses with Aperture Rings




In the case of CPU lenses equipped with an aperture ring (429), lock aperture at the minimum setting (highest f-number).

Basic Photography and Playback

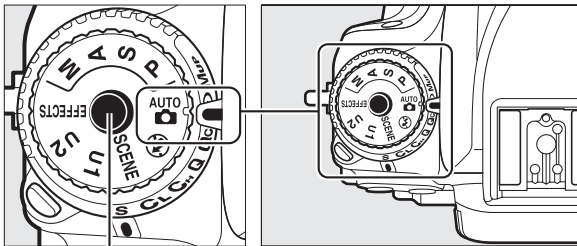
“Point-and-Shoot” Photography (AUTO and Modes)

This section describes how to take photographs in  and  modes.  and  are automatic “point-and-shoot” modes in which the majority of settings are controlled by the camera in response to shooting conditions.



Before proceeding, turn the camera on and select the desired mode by pressing the mode dial lock release and rotating the mode dial to  or  (the only difference between these two modes is that the flash will not fire in  mode).

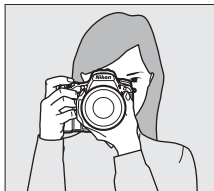
Mode dial



Mode dial lock release

1 Ready the camera.

When framing photographs in the viewfinder, hold the handgrip in your right hand and cradle the camera body or lens with your left.

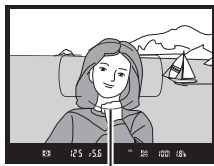


When framing photographs in portrait (tall) orientation, hold the camera as shown at right.



2 Frame the photograph.

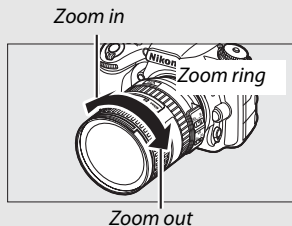
Frame a photograph in the viewfinder with the main subject in the AF area brackets.



AF area brackets

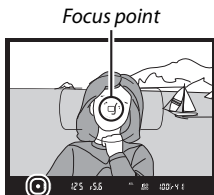
Using a Zoom Lens

Use the zoom ring to zoom in on the subject so that it fills a larger area of the frame, or zoom out to increase the area visible in the final photograph (select longer focal lengths on the lens focal length scale to zoom in, shorter focal lengths to zoom out).



3 Press the shutter-release button halfway.

Press the shutter-release button halfway to focus (if the subject is poorly lit, the flash may pop up and the AF-assist illuminator may light). When the focus operation is complete, the active focus point and in-focus indicator (●) will appear in the viewfinder.

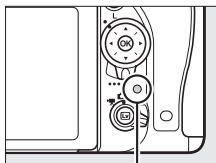


Focus indicator

In-focus indicator	Description
●	Subject in focus.
▶	Focus point is between camera and subject.
◀	Focus point is behind subject.
▶ ◀ (flashes)	Camera unable to focus using autofocus. See page 131.

4 Shoot.

Smoothly press the shutter-release button the rest of the way down to take the photograph. The memory card access lamp will light and the photograph will be displayed in the monitor for a few seconds. *Do not eject the memory card or remove or disconnect the power source until the lamp has gone out and recording is complete.*

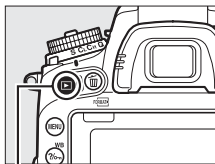


Memory card access lamp

Basic Playback

1 Press the button.



A photograph will be displayed in the monitor. The memory card containing the picture currently displayed is shown by an icon.



 button




2 View additional pictures.

Additional pictures can be displayed by pressing  or .




To end playback and return to shooting mode, press the shutter-release button halfway.

Image Review

When **On** is selected for **Image review** in the playback menu ( 307), photographs are automatically displayed in the monitor for a few seconds after shooting.

Deleting Unwanted Photographs




To delete the photograph currently displayed in the monitor, press the  (FORMAT) button. *Note that photographs can not be recovered once deleted.*

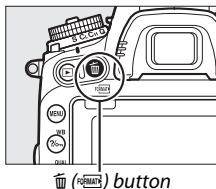
1 Display the photograph.

Display the photograph you wish to delete as described on the preceding page. The location of the current image is shown by an icon at the bottom left corner of the display.



2 Delete the photograph.

Press the  (FORMAT) button. A confirmation dialog will be displayed; press the  (FORMAT) button again to delete the image and return to playback. To exit without deleting the picture, press .



See Also

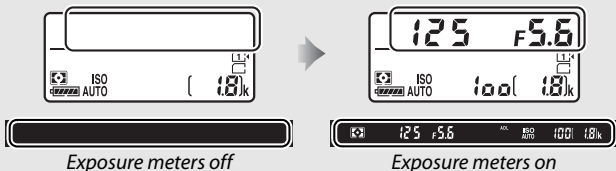
See page 245 for information on choosing a memory card slot.

Delete



To delete selected images (📖 260), all images taken on a selected date (📖 261), or all images in a chosen location on a selected memory card (📖 260), use the **Delete** option in the playback menu.

The Standby Timer (Viewfinder Photography)

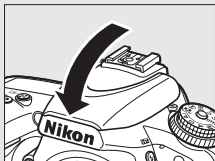
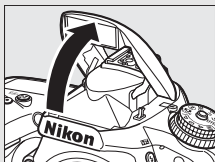
The viewfinder indicator display and control panel shutter speed and aperture display will turn off if no operations are performed for about six seconds, reducing the drain on the battery. Press the shutter-release button halfway to reactivate the display. The length of time before the standby timer expires automatically can be selected using Custom Setting c2 (**Standby timer**, 📖 336).



The Built-in Flash

If additional lighting is required for correct exposure in  mode, the built-in flash will pop up automatically when the shutter-release button is pressed halfway. If the flash is raised, photographs can only be taken when the flash-ready indicator () is displayed. If the flash-ready indicator is not displayed, the flash is charging; remove your finger briefly from the shutter-release button and try again.

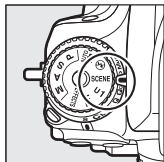
To save power when the flash is not in use, press it gently downward until the latch clicks into place.



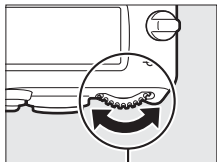
Matching Settings to the Subject or Situation (Scene Mode)

The camera offers a choice of “scene” modes. Choosing a scene mode automatically optimizes settings to suit the selected scene, making creative photography as simple as selecting a mode, framing a picture, and shooting as described on pages 34–36.

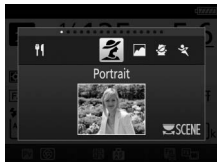
The following scenes can be selected by rotating the mode dial to **SCENE** and rotating the main command dial until the desired scene appears in the monitor. To view the currently selected scene, press **Info**.



















Mode dial



Main command dial



Monitor

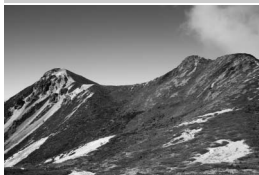
 Portrait	 Beach/snow
 Landscape	 Sunset
 Child	 Dusk/dawn
 Sports	 Pet portrait
 Close up	 Candlelight
 Night portrait	 Blossom
 Night landscape	 Autumn colors
 Party/indoor	 Food

Portrait



Use for portraits with soft, natural-looking skin tones. If the subject is far from the background or a telephoto lens is used, background details will be softened to lend the composition a sense of depth.

Landscape



Use for vivid landscape shots in daylight.

Note

The built-in flash and AF-assist illuminator turn off.

Child



Use for snapshots of children. Clothing and background details are vividly rendered, while skin tones remain soft and natural.

Sports



Fast shutter speeds freeze motion for dynamic sports shots in which the main subject stands out clearly.

Note

The built-in flash and AF-assist illuminator turn off.

Close Up



Use for close-up shots of flowers, insects, and other small objects (a macro lens can be used to focus at very close ranges).

Night Portrait



Use for a natural balance between the main subject and the background in portraits taken under low light.

Night Landscape



Reduce noise and unnatural colors when photographing night landscapes, including street lighting and neon signs.

Note

The built-in flash and AF-assist illuminator turn off.

Party/Indoor



Capture the effects of indoor background lighting. Use for parties and other indoor scenes.

Beach/Snow



Capture the brightness of sunlight expanses of water, snow, or sand.

 **Note**

The built-in flash and AF-assist illuminator turn off.

Sunset



Preserves the deep hues seen in sunsets and sunrises.

 **Note**

The built-in flash and AF-assist illuminator turn off.

Dusk/Dawn



Preserves the colors seen in the weak natural light before dawn or after sunset.

 **Note**

The built-in flash and AF-assist illuminator turn off.

Pet Portrait



Use for portraits of active pets.

 **Note**

The AF-assist illuminator turns off.

Candlelight



For photographs taken by candlelight.

 **Note**

The built-in flash turns off.

Blossom



Use for fields of flowers, orchards in bloom, and other landscapes featuring expanses of blossoms.

 **Note**

The built-in flash turns off.

Autumn Colors



Captures the brilliant reds and yellows in autumn leaves.

 **Note**



The built-in flash turns off.

Food



Use for vivid photographs of food.

 **Note**

For flash photography, press the  (182) button to raise the flash ( 182).

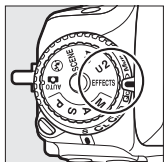
Preventing Blur

Use a tripod to prevent blur caused by camera shake at slow shutter speeds.

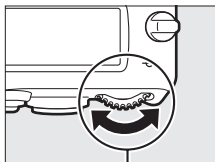
Special Effects

Special effects can be used when taking photographs and shooting movies.

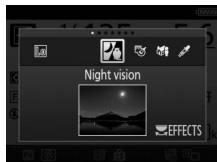
The following effects can be selected by rotating the mode dial to **EFFECTS** and rotating the main command dial until the desired scene appears in the monitor. To view the currently selected effect, press **info**.



Mode dial



Main command dial



Monitor



Night vision



Silhouette



Color sketch



High key



Miniature effect

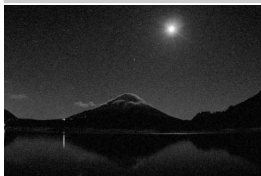


Low key



Selective color

Night Vision




Use under conditions of darkness to record monochrome images at high ISO sensitivities.

Note

Pictures may be affected by noise in the form of randomly-spaced bright pixels, fog, or lines. Manual focus can be used if the camera is unable to focus. The built-in flash turns off.

Color Sketch



The camera detects and colors outlines for a color sketch effect. The effect can be adjusted in live view ( 50).

Note

Movies shot in this mode play back like a slide show made up of a series of stills.

Miniature Effect



Create photos that appear to be pictures of dioramas. Works best when shooting from a high vantage point. Miniature effect movies play back at high speed, compressing about 45 minutes of footage shot at 1920 × 1080/30p into a movie that plays back in about three minutes. The effect can be adjusted in live view (📖 51).

Note

Sound is not recorded with movies. The built-in flash and AF-assist illuminator turn off.

Selective Color



All colors other than the selected colors are recorded in black and white. The effect can be adjusted in live view (📖 52).

Note

The built-in flash turns off.

Silhouette



Silhouette subjects against bright backgrounds.

Note

The built-in flash turns off.

Hi High Key



Use when shooting bright scenes to create bright images that seem filled with light.

Note

The built-in flash turns off.

Lo Low Key



Use when shooting dark scenes to create dark, low-key images with prominent highlights.





Note

The built-in flash turns off.

Preventing Blur

Use a tripod to prevent blur caused by camera shake at slow shutter speeds.

NEF (RAW)

NEF (RAW) recording is not available in , , , and  modes. Pictures taken when an NEF (RAW) or NEF (RAW) + JPEG option is selected in these modes will be recorded as JPEG images. JPEG images created at settings of NEF (RAW)+JPEG will be recorded at the selected JPEG quality, while images recorded at a setting of NEF (RAW) will be recorded as fine-quality images.

Live View and Macro Modes

Autofocus is not available during movie recording. The live view refresh rate will drop, together with the frame rate for continuous release mode; using autofocus during live view photography will disrupt the preview.

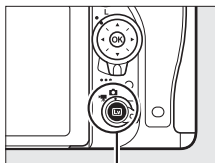
Options Available in Live View

Settings for the selected effect are adjusted in the live view display but apply during live view and viewfinder photography and movie recording.

Color Sketch

1 Select live view.

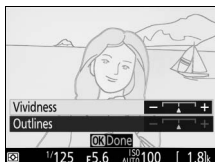
Press the **Lv** button. The view through the lens will be displayed in the monitor.



Lv button

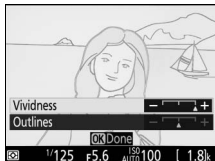
2 Adjust options.

Press **OK** to display the options shown at right. Press **▲** or **▼** to highlight **Vividness** or **Outlines** and press **◀** or **▶** to change. Vividness can be increased to make colors more saturated, or decreased for a washed-out, monochromatic effect, while outlines can be made thicker or thinner. Increasing the thickness of the lines also makes colors more saturated.



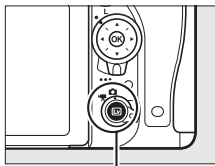
3 Press **OK**.

Press **OK** to exit when settings are complete. To resume viewfinder photography, press the **Lv** button. The selected settings will continue in effect and will apply to photographs and movies recorded in live view or using the viewfinder.



1 Select live view.

Press the **Lv** button. The view through the lens will be displayed in the monitor.



Lv button

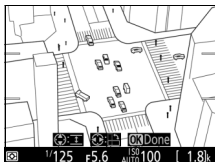
2 Position the focus point.

Use the multi selector to position the focus point in the area that will be in focus and then press the shutter-release button halfway to check focus. To temporarily clear miniature effect options from the display and enlarge the view in the monitor for precise focus, press **QUAL**. Press **ISO** to restore the miniature effect display.



3 Display options.

Press **OK** to display miniature effect options.



4 Adjust options.

Press **←** or **→** to choose the orientation of the area that will be in focus and press **⊖** or **⊕** to adjust its width.



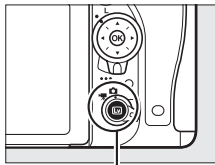
5 Press **OK**.

Press **OK** to exit when settings are complete. To resume viewfinder photography, press the **Lv** button. The selected settings will continue in effect and will apply to photographs and movies recorded in live view or using the viewfinder.

■ **Selective Color**

1 Select live view.

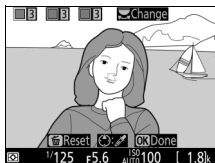
Press the **Lv** button. The view through the lens will be displayed in the monitor.



Lv button

2 Display options.

Press **OK** to display selective color options.





3 Select a color.

Frame an object in the white square in the center of the display and press **OK** to choose the color of the object as one that will remain in the final image (the camera may have difficulty detecting unsaturated colors; choose a saturated color). To zoom in on the center of the display for more precise color selection, press **QUAL**. Press **ISO** to zoom out.

Selected color



4 Choose the color range.

Press  or  to increase or decrease the range of similar hues that will be included in the final image. Choose from values between 1 and 7; note that higher values may include hues from other colors.



Color range

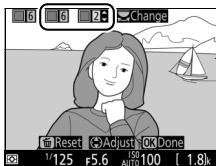


5 Select additional colors.



To select additional colors, rotate the main command dial to highlight another of the three color boxes at the top of the display and repeat Steps 3 and 4 to



select another color. Repeat for a third color if desired. To deselect the highlighted color, press  (FORMAT). To remove all colors, press and hold  (FORMAT). A confirmation dialog will be displayed; select **Yes**.




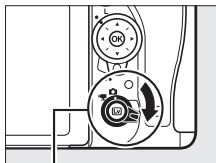
6 Press .

Press  to exit when settings are complete. During shooting, only objects of the selected hues will be recorded in color; all others will be recorded in black-and-white. To resume viewfinder photography, press the  button. The selected settings will continue in effect and will apply to photographs and movies recorded in live view or using the viewfinder.

Live View Photography

Follow the steps below to take photographs in live view.

- 1 Rotate the live view selector to  (live view photography).**



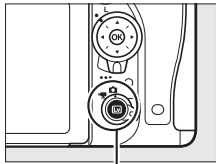
Live view selector

✔ Cover the Viewfinder

To prevent light entering via the viewfinder from interfering with photographs and exposure, remove the rubber eyecup and cover the viewfinder with the supplied eyepiece cap before shooting (📖 107).

- 2 Press the  button.**

The mirror will be raised and the view through the lens will be displayed in the camera monitor. The subject will no longer be visible in the viewfinder.



 *Lv button*

- 3 Position the focus point.**

Position the focus point over your subject as described on page 57.

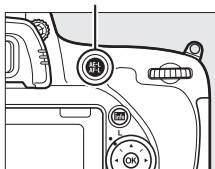
4 Focus.

Press the shutter-release button halfway to focus.

The focus point will flash green while the camera focuses. If the camera is able to focus, the focus point will be displayed in green; if the camera is unable to focus, the focus point will flash red (note that pictures can be taken even when the focus point flashes red; check focus in the monitor before shooting). Exposure can be locked by pressing the ^{AE-L}/_{AF-L} **AE-L/AF-L** button (☞ 141); focus locks while the shutter-release button is pressed halfway.



^{AE-L}/_{AF-L} **AE-L/AF-L** button



If exposure preview is enabled, the effects of shutter speed, aperture, ISO sensitivity, and exposure compensation (☞ 143) can be previewed in the monitor as shown at right (note that although exposure can be adjusted by ± 5 EV, only values between -3 and $+3$ EV will be reflected in the preview display). To enable exposure preview, press the **i** button and select **On** for **Exposure preview** (☞ 62).



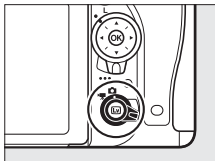
5 Take the picture.

Press the shutter-release button the rest of the way down to shoot. The monitor will turn off.



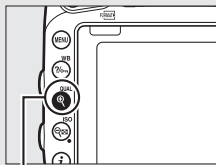
6 Exit live view mode.

Press the **[Lv]** button to exit live view mode.

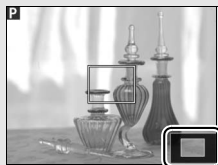


Live View Zoom Preview

Press the **[QUAL]** button to magnify the view in the monitor up to a maximum of about 19×. A navigation window will appear in a gray frame at the bottom right corner of the display. Use the multi selector to scroll to areas of the frame not visible in the monitor or press **[ISO]** to zoom out.




[QUAL] button



Navigation window

The Standby Timer

Regardless of the setting selected for Custom Setting c2 (**Standby timer**,  336), the standby timer will not expire during live view photography.

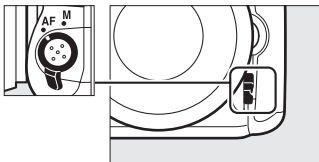
Previewing Focus During Live View Photography (P, S, A, and M Modes Only)

To temporarily select maximum aperture for an improved focus preview during live view photography, press the **Pv** button. To return aperture to its original value, press the button again or focus using autofocus. If the shutter-release button is pressed all the way down to take a picture during focus preview, aperture will return to the original value before the photo is taken.

Focus

To focus using autofocus, rotate the focus-mode selector to **AF** and follow the steps below to choose autofocus and AF-area modes. For information on focusing manually, see page 60.

Focus-mode selector

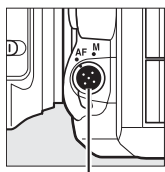


■ ■ Choosing a Focus Mode

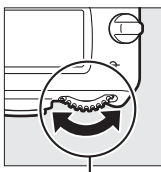
The following autofocus modes are available during live view photography and movie live view:

Mode	Description
AF-S	Single-servo AF: For stationary subjects. Focus locks when shutter-release button is pressed halfway.
AF-F	Full-time servo AF: For moving subjects. Camera focuses continuously until shutter-release button is pressed. Focus locks when shutter-release button is pressed halfway.

To choose an autofocus mode, press the AF-mode button and rotate the main command dial until the desired mode is displayed in the monitor.



AF-mode button











Main command dial



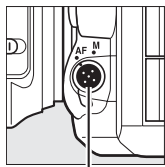
Monitor

■ ■ Choosing an AF-Area Mode

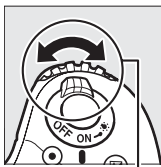
The following AF-area modes can be selected during live view photography and movie live view:

Mode	Description
	Face-priority AF: Use for portraits. The camera automatically detects and focuses on portrait subjects; the selected subject is indicated by a double yellow border (if multiple faces are detected, the camera will focus on the closest subject; to choose a different subject, use the multi selector). If the camera can no longer detect the subject (because, for example, the subject has turned to face away from the camera), the border will no longer be displayed.
	Wide-area AF: Use for hand-held shots of landscapes and other non-portrait subjects. Use the multi selector to move the focus point anywhere in the frame, or press  to position the focus point in the center of the frame.
	Normal-area AF: Use for pin-point focus on a selected spot in the frame. Use the multi selector to move the focus point anywhere in the frame, or press  to position the focus point in the center of the frame. A tripod is recommended.
	Subject-tracking AF: Use the multi selector to position the focus point over your subject and press  to start tracking. The focus point will track the selected subject as it moves through the frame. To end tracking, press  again. Note that the camera may be unable to track subjects if they move quickly, leave the frame or are obscured by other objects, change visibly in size, color, or brightness, or are too small, too large, too bright, too dark, or similar in color or brightness to the background.

To choose an AF-area mode, press the AF-mode button and rotate the sub-command dial until the desired mode is displayed in the monitor.



AF-mode button



Sub-command dial



Monitor

Using Autofocus in Live View Photography and Movie Live View


Use an AF-S lens. The desired results may not be achieved with other lenses or teleconverters. Note that in live view, autofocus is slower and the monitor may brighten or darken while the camera focuses. The focus point may sometimes be displayed in green when the camera is unable to focus. The camera may be unable to focus in the following situations:

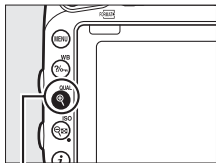
- The subject contains lines parallel to the long edge of the frame
- The subject lacks contrast
- The subject in the focus point contains areas of sharply contrasting brightness, or includes spot lighting or a neon sign or other light source that changes in brightness
- Flicker or banding appears under fluorescent, mercury-vapor, sodium-vapor, or similar lighting
- A cross (star) filter or other special filter is used
- The subject appears smaller than the focus point
- The subject is dominated by regular geometric patterns (e.g., blinds or a row of windows in a skyscraper)
- The subject is moving


Manual Focus

To focus in manual focus mode (📖 132), rotate the lens focus ring until the subject is in focus.





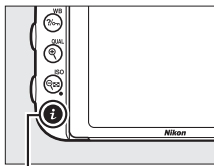
To magnify the view in the monitor for precise focus, press the  (**QUAL**) button.



 (**QUAL**) button

Using the *i* Button



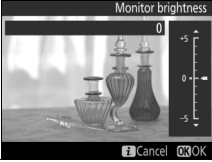
The options listed below can be accessed by pressing the *i* button during live view photography. Highlight items using the multi selector and press  to view options for the highlighted item. After choosing the desired setting, press  to return to the *i*-button menu. Press the *i* button again to exit to the shooting display.









i button



Option	Description
Choose image area	Choose an image area for live view photography (□ 111).
Image quality	Choose image quality (□ 115).
Image size	Choose image size (□ 118).
Set Picture Control	Choose a Picture Control (□ 165).
Active D-Lighting	Adjust Active D-Lighting (□ 175).
Remote control mode (ML-L3)	Choose a remote control mode (□ 193).

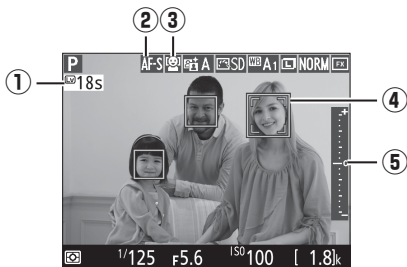
Option	Description
<p>Monitor brightness</p>	<p>Press  or  to adjust monitor brightness for live view photography (note that this affects live view only and has no effect on photographs or movies or on the brightness of the monitor for menus or playback; to adjust the brightness of the monitor for menus and playback without affecting live view photography or movie live view, use the Monitor brightness option in the setup menu as described on page 376).</p> 
<p>Exposure preview</p>	<p>Enable or disable exposure preview. If exposure preview is enabled, the effects of shutter speed, aperture, and ISO sensitivity on exposure can be previewed during live view photography.</p>

Exposure Preview

When exposure preview is enabled, exposure can be adjusted by ± 5 EV ( 143), although only values between -3 and $+3$ EV are reflected in the preview display. Note that the preview may not accurately reflect the final results when flash lighting is used, Active D-Lighting ( 175), High Dynamic Range (HDR;  177), or bracketing is in effect, **A** (auto) is selected for the Picture Control **Contrast** parameter ( 168), or a value other than **0** is selected for **Clarity** ( 168), or **x 200** is selected for shutter speed. If the subject is very bright or very dark, the exposure indicators will flash to warn that the preview may not accurately reflect exposure. Exposure preview is not available in special effect modes or when **b**  **b** or **- -** is selected for shutter speed.




The Live View Display: Live View Photography

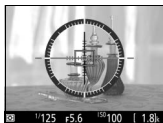


Item	Description	
① Time remaining	The amount of time remaining before live view ends automatically. Displayed if shooting will end in 30 s or less.	65
② Autofocus mode	The current autofocus mode.	57
③ AF-area mode	The current AF-area mode.	58
④ Focus point	The current focus point. The display varies with the option selected for AF-area mode.	54
⑤ Exposure indicator	When On is selected for Exposure preview , the exposure indicator shows the difference between the metered exposure and the exposure that will be achieved at current settings.	94

The Information Display: Live View Photography

To hide or display indicators in the monitor during live view photography, press the **info** button.

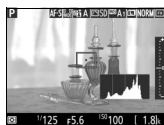
Virtual horizon
( 388)




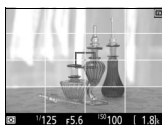
Information on



Information off



Histogram (exposure preview only;  62)



Framing guides

✔ Shooting in Live View Mode

Although they will not appear in the final picture, jagged edges, color fringing, moiré, and bright spots may appear in the monitor, while bright bands may appear in some areas with flashing signs and other intermittent light sources or if the subject is briefly illuminated by a strobe or other bright, momentary light source. In addition, distortion may occur if the camera is panned horizontally or an object moves at high speed through the frame. Flicker and banding visible in the monitor under fluorescent, mercury vapor, or sodium lamps can be reduced using **Flicker reduction** (☞ 380), although they may still be visible in the final photograph at some shutter speeds. When shooting in live view mode, avoid pointing the camera at the sun or other strong light sources. Failure to observe this precaution could result in damage to the camera's internal circuitry.

Movie recording is not available during live view photography and pressing the movie-record button has no effect. Select movie live view (☞ 66) to shoot movies.

✔ The Count Down Display


A count down will be displayed 30 s before live view ends automatically (☞ 63; the timer turns red if live view is about to end to protect the internal circuits or, if an option other than **No limit** is selected for Custom Setting c4—**Monitor off delay** > **Live view**; ☞ 337—5 s before the monitor is due to turn off automatically). Depending on shooting conditions, the timer may appear immediately when live view is selected.

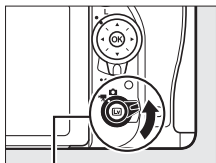
✍ HDMI

If the camera is attached to an HDMI video device during live view photography, the camera monitor will remain on and the video device will display the view through the lens.


Movie Live View

Movies can be recorded in live view.

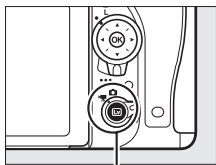
- 1** Rotate the live view selector to  (movie live view).



Live view selector


- 2** Press the  button.

The mirror will be raised and the view through the lens will be displayed in the camera monitor as it would appear in the actual movie, modified for the effects of exposure. The subject will no longer be visible in the viewfinder.



Lv button

The Icon

A  icon ([book 74](#)) indicates that movies can not be recorded.

- 3** Choose a focus mode ([book 57](#)).



4 Choose an AF-area mode (📖 58).



5 Focus.

Frame the opening shot and focus as described in Steps 3 and 4 on pages 54 and 55 (for more information on focusing in movie live view, see page 59). Note that the number of subjects that can be detected in face-priority AF drops during movie recording.




🔍 Exposure

The following settings can be adjusted in movie live view:

	Aperture	Shutter speed	ISO sensitivity (📖 322)	Exposure compensation	Metering
P, S	—	—	—	✓	✓
A	✓	—	—	✓	✓
M	✓	✓	✓	—	✓
SCENE, 📷	—	—	—	✓	—
Other shooting modes	—	—	—	—	—

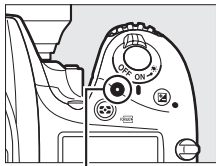
In mode **M**, shutter speed can be set to values between $\frac{1}{25}$ s and $\frac{1}{4000}$ s (the slowest available shutter speed varies with the frame rate; 📖 319). Spot metering is not available during movie live view. If the result is over- or under-exposed, exit and restart movie live view.

White Balance

In modes **P**, **S**, **A**, and **M**, white balance can be set at any time by pressing the  (WB) button and rotating the main command dial (📖 145).

6 Start recording.

Press the movie-record button to start recording. A recording indicator and the time available are displayed in the monitor. Exposure can be locked by pressing the ^{AE-L}_{AF-L} **AE-L/AF-L** button (📖 141) or altered by up to ± 3 EV in steps of $\frac{1}{3}$ EV using exposure compensation (📖 143). In autofocus mode, the camera can be refocused by pressing the shutter-release button halfway.



Movie-record button

Recording indicator



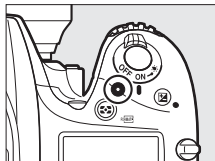
Time remaining

Audio

The camera can record both video and sound; do not cover the microphone on the front of the camera during movie recording (📖 3). Note that the built-in microphone may record sounds made by the camera or lens during autofocus, vibration reduction, or changes to aperture.

7 End recording.

Press the movie-record button again to end recording. Recording will end automatically when the maximum length is reached, or the memory card is full.




Maximum Length

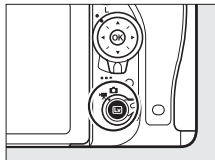
The maximum length for individual movie files is 4 GB (for maximum recording times, see page 319); note that depending on memory card write speed, shooting may end before this length is reached (☞ 491).

The Count-Down Display


A count down will be displayed 30 s before movie recording ends automatically (☞ 63). Depending on shooting conditions, the timer may appear immediately when movie recording begins. Note that regardless of the amount of recording time available, live view will still end automatically when the timer expires. Wait for the internal circuits to cool before resuming movie recording.

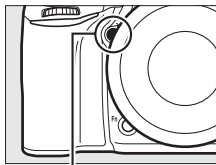
8 Exit movie live view.

Press the  button to exit movie live view.



Indices

If **Index marking** is selected as the “press” option for Custom Setting g1 (**Assign Fn button**, □ 370), g2 (**Assign preview button**, □ 372), or g3 (**Assign AE-L/AF-L button**, □ 373), you can press the selected button during recording to add indices that can be used to locate frames during editing and playback (□ 80; note that indices can not be added in  mode). Up to 20 indices can be added to each movie.





Pv button



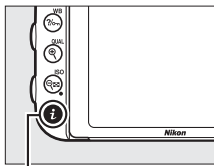
Index

See Also

Frame size, frame rate, microphone sensitivity, card slot, and ISO sensitivity options are available in the movie shooting menu (□ 318). Focus can be adjusted manually as described on page 60. The roles played by the , **Fn**, **Pv**, and  **AE-L/AF-L** buttons can be chosen using Custom Settings f1 (**OK button**; □ 354), g1 (**Assign Fn button**; □ 370), g2 (**Assign preview button**; □ 372), and g3 (**Assign AE-L/AF-L button**, □ 373), respectively (the last three options also allow you to lock exposure without having to keep a button pressed). Custom Setting g4 (**Assign shutter button**; □ 373) controls whether the shutter-release button can be used to start movie live view or to start and end movie recording.

Using the *i* Button

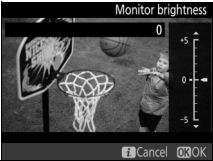
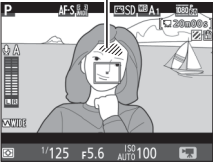

The options listed below can be accessed by pressing the *i* button in movie live view (**Microphone sensitivity, Frequency response, Wind noise reduction, Multi-selector power aperture, and Highlight display** can be adjusted while recording is in progress). Highlight items using the multi selector and press \odot to view options for the highlighted item. After choosing the desired setting, press \odot to return to the *i*-button menu. Press the *i* button again to exit to the shooting display.



i button



Option	Description
Choose image area	Choose image area for movie live view (☞ 76).
Frame size/ frame rate	Select a frame size and rate (☞ 319).
Movie quality	Choose movie quality (☞ 320).
Microphone sensitivity	Press \odot or \odot to adjust microphone sensitivity (☞ 320). Both the built-in and optional stereo microphones are affected. <div data-bbox="643 827 923 1039" data-label="Image"> </div>
Frequency response	Control the frequency response of the built-in microphone or optional stereo microphones (☞ 320).

Option	Description
Wind noise reduction	Enable or disable wind noise reduction using the built-in microphone's low-cut filter (☞ 321).
Set Picture Control	Choose a Picture Control (☞ 321). The Clarity parameter does not apply to movies.
Destination	When two memory cards are inserted, you can choose the card to which movies are recorded (☞ 319).
Monitor brightness	<p>Press \odot or \ominus to adjust monitor brightness for movie live view (note that this affects live view only and has no effect on photographs or movies or on the brightness of the monitor for menus or playback; ☞ 62).</p> 
Multi-selector power aperture	Select Enable to enable power aperture (P , S , A , and M modes only). Press \odot to narrow the aperture, \ominus to widen the aperture.
Highlight display	<p>Choose whether the brightest areas of the frame (highlights) are shown by slanting lines in the display during movie live view. To access this option, select mode P, S, A, or M.</p> 
Headphone volume	<p>Press \odot or \ominus to adjust headphone volume (☞ 73).</p> 

🔍 Power Aperture

Power aperture is not available with some lenses. Power aperture is available only in modes **A** and **M** and can not be used while photo shooting info is displayed (a 🚫 icon indicates that power aperture can not be used).

🔍 Using an External Microphone

The optional stereo microphone can be used to record sound in stereo or to avoid recording focus noise and other sounds made by the lens (📖 443).

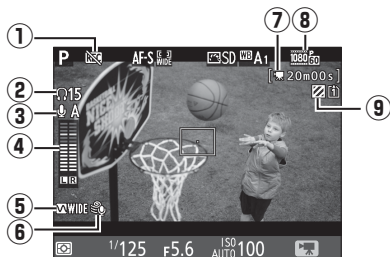
🔍 Headphones

Third-party headphones can be used. Note that high sound levels may result in high volume; particular care should be taken when headphones are used.

🔍 See Also

For information on assigning power aperture to the **Fn** and **Pv** buttons, see Custom Settings g1 (**Assign Fn button**, 📖 370) and g2 (**Assign preview button**, 📖 372). The **Fn** button can be used to widen the aperture, the **Pv** button to narrow the aperture.

The Live View Display: Movie Live View



Item	Description	
① "No movie" icon	Indicates that movies can not be recorded.	—
② Headphone volume	Volume of audio output to headphones. Displayed when third-party headphones are connected.	72
③ Microphone sensitivity	Microphone sensitivity.	71, 320
④ Sound level	Sound level for audio recording. Displayed in red if level is too high; adjust microphone sensitivity accordingly.	71
⑤ Frequency response	The current frequency response.	71, 320
⑥ Wind noise reduction	Displayed when wind noise reduction is on.	72, 321
⑦ Time remaining (movie live view)	The recording time available for movies.	68
⑧ Movie frame size	The frame size for movie recording.	71, 319
⑨ Highlight display indicator	Appears when highlight display is enabled.	72

The Information Display: Movie Live View

To hide or display indicators in the monitor during movie live view, press the **Info** button.

Virtual horizon
(388)



Information on



Information off



Histogram

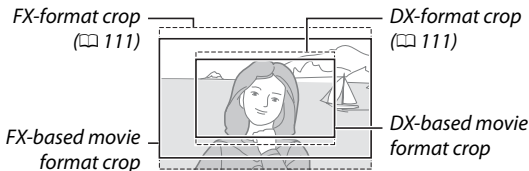



Framing guides



Image Area

Movies and photographs recorded in movie live view (📖 66) have an aspect ratio of 16 : 9.



Images recorded with **On** selected for **Image area > Auto DX crop** in the movie shooting menu (📖 318) and a DX lens attached use a DX-based movie format, as do images recorded with **DX (24×16)** selected for **Image area > Choose image area**. Other images use an FX-based movie format. A  icon is displayed when the DX-based movie format is selected. The approximate size of the area at the center of the image sensor used to record photographs taken in movie live view is 35.9 × 20.2 mm when the FX-based movie format is selected and 23.5 × 13.2 mm when the DX-based movie format is selected.



Taking Photos During Movie Live View




If **Take photos** is selected for Custom Setting g4 (**Assign shutter button**,  373), photographs can be taken at any time during movie live view by pressing the shutter-release button all the way down. If movie recording is in progress, recording will end and the footage recorded to that point will be saved. The photograph will be recorded at the current image area setting using a crop with an aspect ratio of 16 : 9. Image quality is determined by the option selected for **Image quality** in the photo shooting menu ( 115). Note that the exposure for photographs can not be previewed during movie live view. For accurate results when shooting in mode **M**, adjust exposure in live view photography ( 93), then start movie live view and check the image area before beginning recording.



Image Size

The following table shows the size of photographs taken in movie live view:

Image area	Option	Size (pixels)	Print size (cm/in.)*
FX-based movie format	Large	6016 × 3376	50.9 × 28.6/20.1 × 11.3
	Medium	4512 × 2528	38.2 × 21.4/15.0 × 8.4
	Small	3008 × 1688	25.5 × 14.3/10.0 × 5.6
DX-based movie format	Large	3936 × 2224	33.3 × 18.8/13.1 × 7.4
	Medium	2944 × 1664	24.9 × 14.1/ 9.8 × 5.5
	Small	1968 × 1112	16.7 × 9.4/ 6.6 × 3.7

* Approximate size when printed at 300 dpi. Print size in inches equals image size in pixels divided by printer resolution in **dots per inch** (dpi; 1 inch = approximately 2.54 cm).

HDMI

If the camera is connected to an HDMI device (□ 277), the view through the lens will appear both in the camera monitor and on the HDMI device. To use live view when the camera is connected to an HDMI-CEC device, select **Off** for **HDMI > Device control** in the setup menu (□ 278).

Wireless Remote Controllers and Remote Cords

If **Record movies** is selected for Custom Setting g4 (**Assign shutter button**, □ 373), the shutter-release buttons on optional wireless remote controllers (□ 197, 444) and remote cords (□ 443) can be used to start movie live view and to start and end movie recording.




Recording Movies

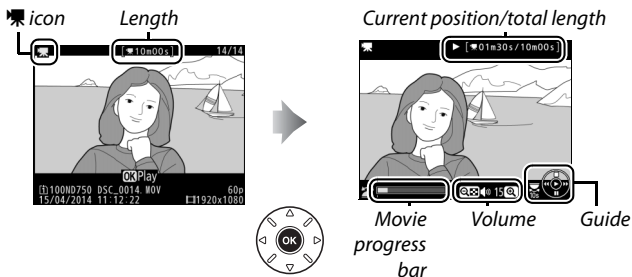
Movies are recorded in the sRGB color space. Flicker, banding, or distortion may be visible in the monitor and in the final movie under fluorescent, mercury vapor, or sodium lamps or if the camera is panned horizontally or an object moves at high speed through frame (for information on reducing flicker and banding, see **Flicker reduction**, □ 380). Flicker may also appear while power aperture is in use. Jagged edges, color fringing, moiré, and bright spots may also appear. Bright bands may appear in some areas of the frame with flashing signs and other intermittent light sources or if the subject is briefly illuminated by a strobe or other bright, momentary light source. When recording movies, avoid pointing the camera at the sun or other strong light sources. Failure to observe this precaution could result in damage to the camera's internal circuitry. Note that noise (randomly-spaced bright pixels, fog, or lines) and unexpected colors may appear if you zoom in on the view through the lens (□ 56) during movie live view.

Flash lighting can not be used during movie live view.

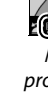





Recording ends automatically if the mode dial is rotated.

Viewing Movies

Movies are indicated by a  icon in full-frame playback ( 241). Press  to start playback; your current position is indicated by the movie progress bar.



The following operations can be performed:

To	Use	Description
Pause		Pause playback.
Play		Resume playback when movie is paused or during rewind/advance.
Rewind/advance		Speed increases with  each press, from 2x to 4x to 8x to 16x; keep pressed to skip to beginning or end of movie (first frame is indicated by  in top right corner of monitor, last frame by ). If playback is paused, movie rewinds or advances one frame at a time; keep pressed for continuous rewind or advance.

To	Use	Description
Skip 10 s		Rotate the main command dial one stop to skip ahead or back 10 s.
Skip ahead/ back		Rotate the sub-command dial to skip to next or previous index, or to skip to the last or first frame if the movie contains no indices.
Adjust volume	(QUAL) / (ISO)	Press (QUAL) to increase volume, (ISO) to decrease.
Trim movie	i	See page 81 for more information.
Exit		Exit to full-frame playback.
Return to shooting mode		Press the shutter-release button halfway to exit to shooting mode.



The Icon

Movies with indices (📖 70) are indicated by a icon in full-frame playback.



Editing Movies

Trim footage to create edited copies of movies or save selected frames as JPEG stills.

Option	Description
 Choose start/end point	Create a copy from which the opening or closing footage has been removed.
 Save selected frame	Save a selected frame as a JPEG still.

Trimming Movies

To create trimmed copies of movies:

1 Display a movie full frame (📖 241).

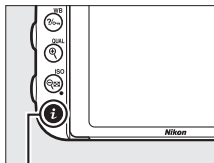
2 Pause the movie on the new opening or closing frame.

Play the movie back as described on page 79, pressing **OK** to start and resume playback and **⏸** to pause and pressing **⏪** or **⏩** or rotating the main or sub-command dial to locate the desired frame. Your approximate position in the movie can be ascertained from the movie progress bar. Pause playback when you reach the new opening or closing frame.

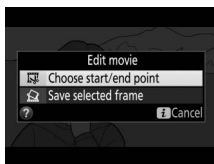


Movie progress bar

- 3 Select Choose start/end point.**
Press the **i** button, then highlight **Choose start/end point** and press **OK**.

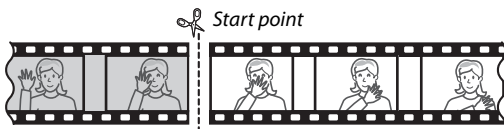
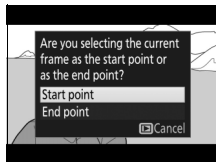


i button

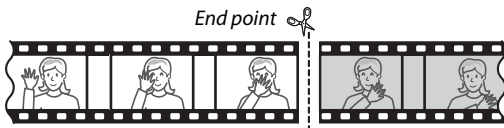


4 Choose the current frame as the new start or end point.

To create a copy that begins from the current frame, highlight **Start point** and press **OK**. The frames before the current frame will be removed when you save the copy.



To create a copy that ends at the current frame, highlight **End point** and press **OK**. The frames after the current frame will be removed when you save the copy.




5 Confirm the new start or end point.




If the desired frame is not currently displayed, press **⏮** or **⏭** to advance or rewind (to skip to 10 s ahead or back, rotate the main command dial one stop; to skip to an index, or to the first or last frame if the movie contains no indices, rotate the sub-command dial).

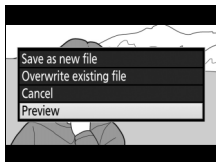


6 Create the copy.



Once the desired frame is displayed, press .

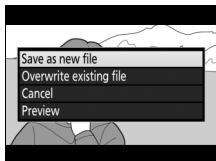
7 Preview the movie.

To preview the copy, highlight **Preview** and press  (to interrupt the preview and return to the save options menu, press ). To abandon the current copy and return to Step 5, highlight **Cancel** and press ; to save the copy, proceed to Step 8.



8 Save the copy.

Highlight **Save as new file** and press  to save the copy to a new file. To replace the original movie file with the edited copy, highlight **Overwrite existing file** and press .



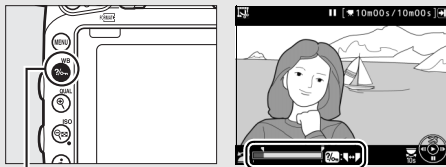
✎ Trimming Movies

Movies must be at least two seconds long. The copy will not be saved if there is insufficient space available on the memory card.

Copies have the same time and date of creation as the original.

✎ Choosing the Role of the Current Frame

To make the frame displayed in Step 5 the new end point (▮) instead of the new start point (▮) or vice versa, press the **WB** button.



WB (WB) button

✎ The Retouch Menu

Movies can also be edited using the **Edit movie** option in the retouch menu (📖 393).

Saving Selected Frames

To save a copy of a selected frame as a JPEG still:

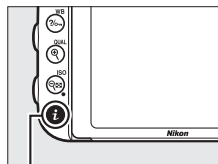
1 Pause the movie on the desired frame.

Play the movie back as described on page 79, pressing **OK** to start and resume playback and **STOP** to pause. Pause the movie at the frame you intend to copy.

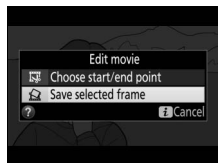


2 Choose Save selected frame.


Press the **i** button, then highlight **Save selected frame** and press **OK**.



i button





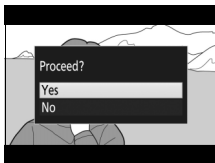
3 Create a still copy.

Press  to create a still copy of the current frame.




4 Save the copy.

Highlight **Yes** and press  to create a fine-quality ( 115) JPEG copy of the selected frame.



Save Selected Frame

JPEG movie stills created with the **Save selected frame** option can not be retouched. JPEG movie stills lack some categories of photo information ( 246).

P, S, A, and M Modes

P, S, A, and M modes offer different degrees of control over shutter speed and aperture.



Mode	Description
P	Programmed auto (☐ 89): Camera sets shutter speed and aperture for optimal exposure. Recommended for snapshots and in other situations in which there is little time to adjust camera settings.
S	Shutter-priority auto (☐ 90): User chooses shutter speed; camera selects aperture for best results. Use to freeze or blur motion.
A	Aperture-priority auto (☐ 91): User chooses aperture; camera selects shutter speed for best results. Use to blur background or bring both foreground and background into focus.
M	Manual (☐ 93): User controls both shutter speed and aperture. Set shutter speed to Bulb (b u l b) or Time (- -) for long time-exposures.

Lens Types

When using a CPU lens equipped with an aperture ring (☐ 429), lock the aperture ring at the minimum aperture (highest f-number). Type G and E lenses are not equipped with an aperture ring.

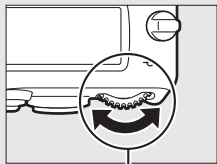
Non-CPU lenses can only be used in modes **A** (aperture-priority auto) and **M** (manual), when aperture can only be adjusted using the lens aperture ring. Selecting any other mode disables the shutter release. For more information, see “Compatible Lenses” (☐ 426).

P: Programmed Auto

In this mode, the camera automatically adjusts shutter speed and aperture according to a built-in program to ensure optimal exposure in most situations.

Flexible Program

In mode **P**, different combinations of shutter speed and aperture can be selected by rotating the main command dial while the exposure meters are on (“flexible program”). Rotate the dial to the right for large apertures (low f-numbers) that blur background details or fast shutter speeds that “freeze” motion. Rotate the dial to the left for small apertures (high f-numbers) that increase depth of field or slow shutter speeds that blur motion. All combinations produce the same exposure. While flexible program is in effect, a **B** indicator appears in the viewfinder. To restore default shutter speed and aperture settings, rotate the main command dial until the indicator is no longer displayed, choose another mode, or turn the camera off.



Main command dial



Viewfinder

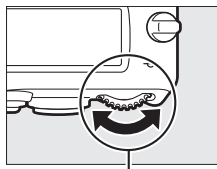
See Also

See page 462 for information on the built-in exposure program. For information on activating the exposure meters, see “The Standby Timer (Viewfinder Photography)” on page 39.

S: Shutter-Priority Auto

In shutter-priority auto, you choose the shutter speed while the camera automatically selects the aperture that will produce the optimal exposure.

To choose a shutter speed, rotate the main command dial while the exposure meters are on. Shutter speed can be set to "x 200" or to values between 30 s and $\frac{1}{4000}$ S.



Main command dial



Control panel

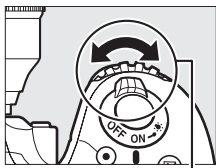
See Also

See page 472 for information on what to do if flashing "bulb" or "- -" indicator appears in the shutter-speed displays.

A: Aperture-Priority Auto

In aperture-priority auto, you choose the aperture while the camera automatically selects the shutter speed that will produce the optimal exposure.

To choose an aperture between the minimum and maximum values for the lens, rotate the sub-command dial while the exposure meters are on.



Sub-command dial



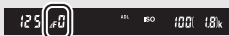
Control panel

Non-CPU Lenses (□ 427)

Use the lens aperture ring to adjust aperture. If the maximum aperture of the lens has been specified using the **Non-CPU lens data** item in setup menu (□ 235) when a non-CPU lens is

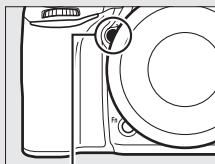
attached, the current f-number will be displayed in the viewfinder and control panel, rounded to the nearest full stop.

Otherwise the aperture displays will show only the number of stops (ΔF , with maximum aperture displayed as $\Delta F0$) and the f-number must be read from the lens aperture ring.



Depth-of-Field Preview

To preview the effects of aperture, press and hold the **Pv** button. The lens will be stopped down to the aperture value selected by the camera (modes **P** and **S**) or the value chosen by the user (modes **A** and **M**), allowing depth of field to be previewed in the viewfinder.



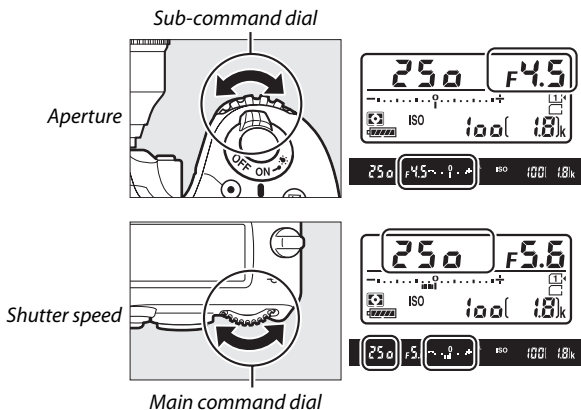
Pv button

Custom Setting e5—Modeling Flash

This setting controls whether the built-in flash and optional flash units that support the Nikon Creative Lighting System (CLS; □ 433) will emit a modeling flash when the **Pv** button is pressed. See page 353 for more information.

M: Manual


In manual exposure mode, you control both shutter speed and aperture. While the exposure meters are on, rotate the main command dial to choose a shutter speed, and the sub-command dial to set aperture. Shutter speed can be set to “x 200” or to values between 30 s and $\frac{1}{4000}$ s, or the shutter can be held open indefinitely for a long time-exposure (bulb or - -, 95). Aperture can be set to values between the minimum and maximum values for the lens. Use the exposure indicators to check exposure.



AF Micro NIKKOR Lenses


Provided that an external exposure meter is used, the exposure ratio need only be taken into account when the lens aperture ring is used to set aperture.

The Exposure Indicators

If a shutter speed other than “bulb” or “time” is selected, the exposure indicators in the viewfinder and control panel show whether the photograph would be under- or over-exposed at current settings. Depending on the option chosen for Custom Setting b2 (**EV steps for exposure cntrl**,  333), the amount of under- or over-exposure is shown in increments of $\frac{1}{3}$ EV or $\frac{1}{2}$ EV. If the limits of the exposure metering system are exceeded, the displays will flash.

Custom Setting b2 set to $\frac{1}{3}$ step			
	Optimal exposure	Underexposed by $\frac{1}{3}$ EV	Overexposed by 2 EV
Control panel	-.....0.....+	-.....0.....+	-.....0.....+
Viewfinder	- . . 0 . . +	- . . 0 . . +	- . . 0 +

See Also

For information on reversing the exposure indicators so that negative values are displayed on the right and positive values on the left, see Custom Setting f8 (**Reverse indicators**,  366).

Long Time-Exposures (M Mode Only)

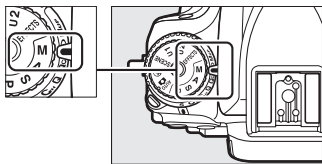
Select the following shutter speeds for long time-exposures of moving lights, the stars, night scenery, or fireworks.

- **Bulb** (b, L, B): The shutter remains open while the shutter-release button is held down. To prevent blur, use a tripod or an optional wireless remote controller (☐ 197, 444) or remote cord (☐ 443).
- **Time** (- -): Start the exposure using the shutter-release button on the camera or on an optional remote control, remote cord, or wireless remote controller. The shutter remains open for thirty minutes or until the button is pressed a second time.

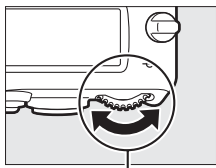


*Length of exposure: 35 s
Aperture: f/25*

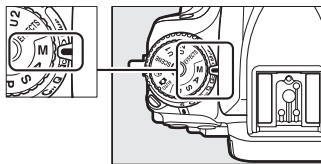
Before proceeding, mount the camera on a tripod or place it on a stable, level surface. To prevent light entering via the viewfinder from appearing in the photograph or interfering with exposure, remove the rubber eyecup and cover the viewfinder with the supplied eyepiece cap (☐ 107). Nikon recommends using a fully charged battery or an optional AC adapter and power connector to prevent loss of power while the shutter is open. Note that noise (bright spots, randomly-spaced bright pixels, or fog) may be present in long exposures; before shooting, choose **On** for **Long exposure NR** in the photo shooting menu (☐ 317).

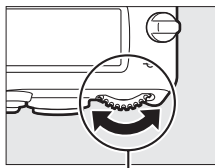
1 Rotate the mode dial to **M**. *Mode dial***2** Choose a shutter speed.

While the exposure meters are on, rotate the main command dial to choose a shutter speed of "Bulb" (bulb).

*Main command dial**Control panel***3** Take the photograph.

After focusing, press the shutter-release button on the camera, optional wireless remote controller or remote cord all the way down. Remove your finger from the shutter-release button when the exposure is complete.

1 Rotate the mode dial to M. *Mode dial*

2 Choose a shutter speed.
While the exposure meters are on, rotate the main command dial left to choose a shutter speed of "Time" (- -).*Main command dial**Control panel*

3 Open the shutter.
After focusing, press the shutter-release button on the camera or optional remote control, remote cord, or wireless remote controller all the way down.

4 Close the shutter.
Repeat the operation performed in Step 3 (shooting ends automatically if the button is not pressed after 30 minutes).

ML-L3 Remote Controls

If you will be using an ML-L3 remote control, select a remote control mode (**Delayed remote**, **Quick-response remote**, or **Remote mirror-up**) using the **Remote control mode (ML-L3)** option in the photo shooting menu (☰ 193). Note that if you are using an ML-L3 remote control, pictures will be taken in “Time” mode even when “Bulb”/bulb is selected for shutter speed.

User Settings: U1 and U2 Modes

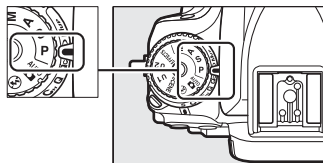
Assign frequently-used settings to the **U1** and **U2** positions on the mode dial.

Saving User Settings

1 Select a mode.

Rotate the mode dial to the desired mode.


Mode dial

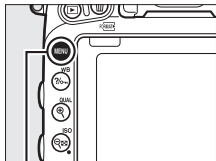


2 Adjust settings.

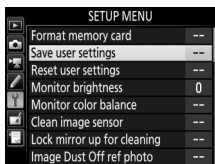
Make the desired adjustments to flexible program (mode **P**), shutter speed (modes **S** and **M**), aperture (modes **A** and **M**), exposure and flash compensation, flash mode, focus point, metering, autofocus and AF-area modes, bracketing, and settings in the shooting (📖 310, 318) and Custom Settings (📖 323) menus.

3 Select **Save user settings**.

Press the **MENU** button to display the menus. Highlight **Save user settings** in the setup menu and press .

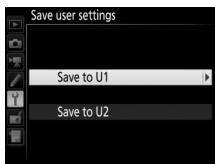


MENU button




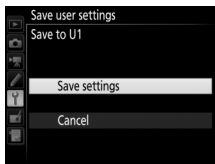
4 Select **Save to U1** or **Save to U2**.

Highlight **Save to U1** or **Save to U2** and press .



5 **Save user settings**.

Highlight **Save settings** and press  to assign the settings selected in Steps 1 and 2 to the mode dial position selected in Step 4.



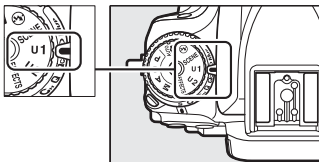
Saved Settings

Some photo and movie shooting menu settings are not stored. See pages 310 and 318 for more information.

Recalling User Settings

Simply rotate the mode dial to **U1** to recall the settings assigned to **Save to U1**, or to **U2** to recall the settings assigned to **Save to U2**.

Mode dial

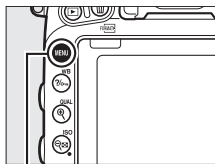


Resetting User Settings

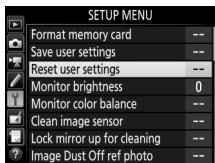
To reset settings for **U1** or **U2** to default values:

1 Select **Reset user settings**.


Press the **MENU** button to display the menus. Highlight **Reset user settings** in the setup menu and press .

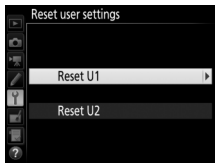


MENU button

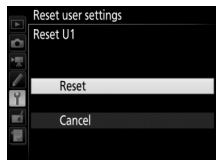


2 Select **Reset U1** or **Reset U2**.

Highlight **Reset U1** or **Reset U2** and press .



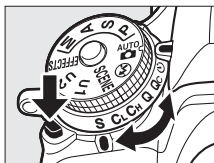
-
- 3** Reset user settings.
Highlight **Reset** and press **OK**.



Release Mode

Choosing a Release Mode

To choose a release mode, press the release mode dial lock release and turn the release mode dial to the desired setting.



Mode	Description
S	Single frame: Camera takes one photograph each time shutter-release button is pressed.
CL	Continuous low speed: While shutter-release button is held down, camera records 1–6 frames per second. * Frame rate can be chosen using Custom Setting d2 (Continuous low-speed , □ 338). Note that only one picture will be taken if the flash fires.
CH	Continuous high speed: While shutter-release button is held down, camera records up to 6.5 frames per second. * Use for active subjects. Note that only one picture will be taken if the flash fires.
Q	Quiet shutter-release: As for single frame, except that mirror does not click back into place while shutter-release button is fully pressed, allowing user to control timing of click made by mirror, which is also quieter than in single frame mode. In addition, beep does not sound regardless of setting selected for Custom Setting d1 (Beep ; □ 338).
Qc	Qc (quiet continuous) shutter-release: While shutter-release button is held down, camera records up to 3 frames per second. * Camera noise is reduced. Note that only one picture will be taken if the flash fires.
⌚	Self-timer: Take pictures with the self-timer (□ 106).

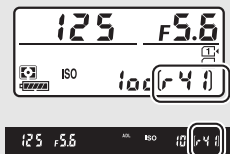
Mode	Description
MUp	Mirror up: Choose this mode to minimize camera shake in telephoto or close-up photography or in other situations in which the slightest camera movement can result in blurred photographs (□ 109).

* Average frame rate with an EN-EL15 battery, continuous-servo AF, manual or shutter-priority auto exposure, a shutter speed of $\frac{1}{200}$ s or faster, remaining settings (or in the case of **CL**, remaining settings other than Custom Setting d2) at default values, and memory remaining in memory buffer. The stated rates may not be available under some conditions. Frame rates may drop at extremely small apertures (high f-numbers) or slow shutter speeds, when vibration reduction (available with VR lenses) or auto ISO sensitivity control (□ 136) is on, or when the battery is low, a non-CPU lens is attached, or **Aperture ring** is selected for Custom Setting f5 (**Customize command dials**) > **Aperture setting** (□ 364).

The Memory Buffer

The camera is equipped with a memory buffer for temporary storage, allowing shooting to continue while photographs are being saved to the memory card. Up to 100 photographs can be taken in succession; note, however, that the frame rate will drop when the buffer is full (r00).

The approximate number of images that can be stored in the buffer at current settings is shown in the exposure-count displays in the viewfinder and control panel while the shutter-release button is pressed. The illustration at right shows the display when space remains in the buffer for about 41 pictures.



While photographs are being recorded to the memory card, the memory card access lamp will light. Depending on shooting conditions and memory card performance, recording may take from a few seconds to a few minutes. *Do not remove the memory card or remove or disconnect the power source until the access lamp has gone out.* If the camera is switched off while data remain in the buffer, the power will not turn off until all images in the buffer have been recorded. If the battery is exhausted while images remain in the buffer, the shutter release will be disabled and the images transferred to the memory card.

Live View

If a continuous release mode is used during live view photography (□ 54) or in movie live view (□ 66), photographs will be displayed in place of the view through the lens while the shutter-release button is pressed.

See Also

For information on choosing the maximum number of photographs that can be taken in a single burst, see Custom Setting d3 (**Max. continuous release**, □ 339). For information on the number of pictures that can be taken in a single burst, see page 492.

Self-Timer Mode (☺)

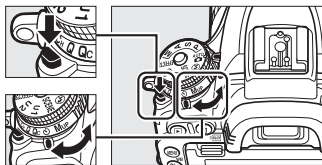
The self-timer can be used to reduce camera shake or for self-portraits.

1 Mount the camera on a tripod.

Mount the camera on a tripod or place the camera on a stable, level surface.

2 Select self-timer mode.

Press the release mode dial lock release and turn the release mode dial to ☺.



Release mode dial

3 Frame the photograph and focus.

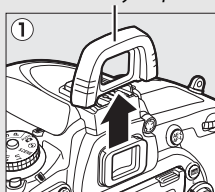
In single-servo AF (☐ 121), photographs can only be taken if the in-focus (●) indicator appears in the viewfinder.



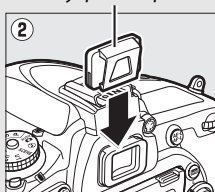
Cover the Viewfinder

When taking photos without your eye to the viewfinder, remove the rubber eyecup (①) and insert the supplied eyepiece cap as shown (②). This prevents light entering via the viewfinder from appearing in photographs or interfering with exposure. Hold the camera firmly when removing the rubber eyecup.

Rubber eyecup



Eyepiece cap








4 Start the timer.

Press the shutter-release button all the way down to start the timer. The self-timer lamp will start to flash. Two seconds before the photograph is taken, the self-timer lamp will stop flashing. The shutter will be released about ten seconds after the timer starts.





To turn the self-timer off before a photograph is taken, turn the release mode dial to another setting.

✔ Using the Built-in Flash

Before taking a photograph with the flash in modes that require the flash to be raised manually, press the  () button to raise the flash and wait for the  indicator to be displayed in the viewfinder ( 182). Shooting will be interrupted if the flash is raised after the self-timer has started. Note that only one photograph will be taken when the flash fires, regardless of the number of exposures selected for Custom Setting c3 (**Self-timer**;  337).

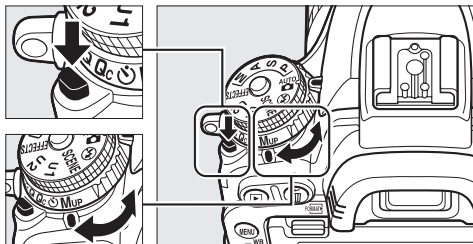
See Also

For information on choosing the duration of the self-timer, the number of shots taken, and the interval between shots, see Custom Setting c3 (**Self-timer**;  337). For information on controlling the beeps that sound when the self-timer is used, see Custom Setting d1 (**Beep**;  338).

Mirror up Mode (MUP)

Choose this mode to minimize blurring caused by camera movement when the mirror is raised. To use mirror-up mode, press the release mode dial lock release and rotate the release mode dial to **MUP** (mirror up).

Release mode dial lock release



Release mode dial

After pressing the shutter-release button halfway to set focus and exposure, press the shutter-release button the rest of the way down to raise the mirror and then press the shutter-release button all the way down again to take the picture. The mirror lowers when shooting ends.

Mirror Up

While the mirror is raised, photos can not be framed in the viewfinder and autofocus and metering will not be performed.

Mirror up Mode

A picture will be taken automatically if no operations are performed for about 30 s with the mirror raised.

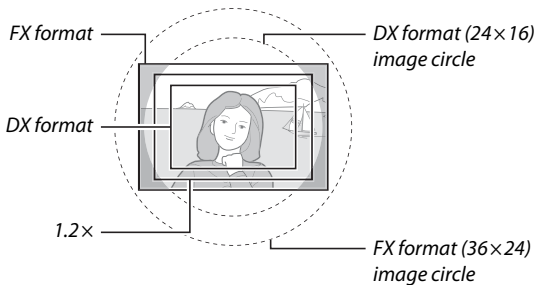
Preventing Blur

To prevent blurring caused by camera movement, press the shutter-release button smoothly, or use an optional remote cord (□ 443). For information on using the optional ML-L3 remote control for mirror-up photography, see page 193. Use of a tripod is recommended.

Image Recording Options




Image Area

Choose from image areas of **FX (36 × 24) 1.0x** (FX format), **DX (24 × 16) 1.5x** (DX format), and **1.2x (30 × 20) 1.2x**. See page 492 for information on the number of pictures that can be stored at different image area settings.



■ ■ Image Area Options

The camera offers a choice of the following image areas:

Option	Description
 FX (36×24) 1.0× (FX format)	Images are recorded in FX format using the full area of the image sensor (35.9 × 24.0 mm), producing an angle of view equivalent to a NIKKOR lens on a 35mm format camera.
 1.2× (30×20) 1.2×	A 29.9 × 19.9 mm area at the center of the image sensor is used to record photographs. To calculate the approximate focal length of the lens in 35mm format, multiply by 1.2. This option is not available in movie shooting menu.
 DX (24×16) 1.5× (DX format)	An area at the center of the image sensor 23.5 × 15.7 mm is used to record pictures in DX format. To calculate the approximate focal length of the lens in 35mm format, multiply by 1.5.

■ ■ Automatic Crop Selection

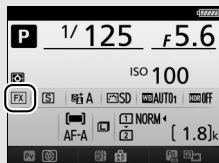
To automatically select a DX crop when a DX lens is attached, select **On** for **Image area > Auto DX crop** in the shooting menus (☰ 310, 318). The image area selected in the shooting menus or with the camera controls will be used only when a non-DX lens is attached. Select **Off** to use the currently-selected image area with all lenses.

Auto DX Crop

The controls listed on page 114 can not be used to select image area when a DX lens is attached and **Auto DX crop** is on.

Image Area

The selected option is shown in the information display.

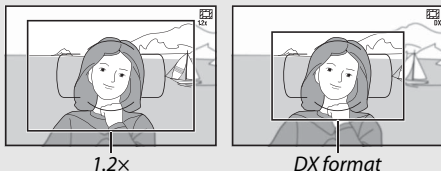


DX Lenses

DX lenses are designed for use with DX format cameras and have a smaller angle of view than lenses for 35mm format cameras. If **Auto DX crop** is off and an option other than **DX (24x16)** (DX format) is selected for **Choose image area** when a DX lens is attached, the edges of the image may be eclipsed. This may not be apparent in the viewfinder, but when the images are played back you may notice a drop in resolution or that the edges of the picture are blacked out.

The Viewfinder Display

The 1.2x and DX format crops are shown below.




See Also

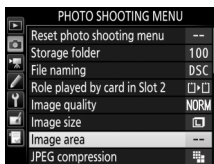
See page 76 for information on the crops available in movie live view.

The image area can be selected using the **Image area > Choose image area** option in the shooting menus or by pressing a control and rotating a command dial.


■ The Image Area Menu

1 Select Image area.

Highlight **Image area** in either of the shooting menus and press .





2 Select Choose image area.

Highlight **Choose image area** and press .



3 Adjust settings.

Choose an option and press . The selected crop is displayed in the viewfinder ( 112).

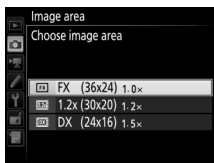



Image Size

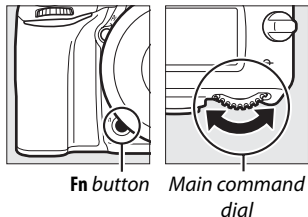
Image size varies with the option selected for image area ( 118).

1 Assign image area selection to a camera control.

Select **Choose image area** as the “press + command dials” option for a camera control in the Custom Settings menu (□ 323). Image area selection can be assigned to the **Fn** button (Custom Setting f2, **Assign Fn button**, □ 356), the **Pv** button (Custom Setting f3, **Assign preview button**, □ 361), or the **AE-L/AF-L** button (Custom Setting f4, **Assign AE-L/AF-L button**, □ 361).

2 Use the selected control to choose an image area.

The image area can be selected by pressing the selected button and rotating the main or sub-command dial until the desired crop is displayed in the viewfinder (□ 112).



The option currently selected for image area can be viewed by pressing the button to display the image area in the control panel, viewfinder, or information display.

FX format is displayed as “36 – 24”, 1.2 × as “30 – 20”, and DX format as “24 – 16”.



Image Quality and Size

Together, image quality and size determine how much space each photograph occupies on the memory card. Larger, higher quality images can be printed at larger sizes but also require more memory, meaning that fewer such images can be stored on the memory card (📖 492).

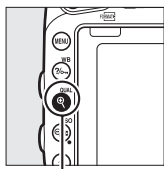
Image Quality

Choose a file format and compression ratio (image quality).

Option	File type	Description
NEF (RAW)	NEF	Raw data from the image sensor are saved without additional processing. Settings such as white balance and contrast can be adjusted after shooting.
JPEG fine	JPEG	Record JPEG images at a compression ratio of roughly 1:4 (fine quality).*
JPEG normal		Record JPEG images at a compression ratio of roughly 1:8 (normal quality).*
JPEG basic		Record JPEG images at a compression ratio of roughly 1:16 (basic quality).*
NEF (RAW)+ JPEG fine	NEF/ JPEG	Two images are recorded, one NEF (RAW) image and one fine-quality JPEG image.
NEF (RAW)+ JPEG normal		Two images are recorded, one NEF (RAW) image and one normal-quality JPEG image.
NEF (RAW)+ JPEG basic		Two images are recorded, one NEF (RAW) image and one basic-quality JPEG image.

* **Size priority** selected for **JPEG compression**. The compression ratio is an approximation only; the actual ratio varies with ISO sensitivity and the scene recorded.

Image quality can be set by pressing the **Q** (**QUAL**) button and rotating the main command dial until the desired setting is displayed in the information display.



Q (**QUAL**) button






Main command dial



Information display


NEF (RAW) Images

NEF (RAW) images can be viewed on the camera or using software such as ViewNX 2 or Capture NX-D (ViewNX 2 can be installed from the supplied installer CD, while Capture NX-D can be downloaded from a link in the ViewNX 2 installer;  262, 268). Note that the option selected for image size does not affect the size of NEF (RAW) images; when viewed on a computer, NEF (RAW) images have the dimensions given for large (-size) images in the table on page 118. JPEG copies of NEF (RAW) images can be created using the **NEF (RAW) processing** option in the retouch menu ( 406).


NEF+JPEG



When photographs taken at settings of NEF (RAW) + JPEG are viewed on the camera with only one memory card inserted, only the JPEG image will be displayed. If both copies are recorded to the same memory card, both copies will be erased when the photo is deleted. If the JPEG copy is recorded to a separate memory card using the **Role played by card in Slot 2 > RAW Slot 1—JPEG Slot 2** option, deleting the JPEG copy will not delete the NEF (RAW) image.

The Photo Shooting Menu


Image quality can also be adjusted using the **Image quality** option in the photo shooting menu ( 310).



■ ■ JPEG Compression

To choose the type of compression for JPEG images, highlight **JPEG compression** in the photo shooting menu and press .


Option	Description
 Size priority	Images are compressed to produce relatively uniform file size.
 Optimal quality	Optimal image quality. File size varies with scene recorded.

■ ■ Type

To choose the type of compression for NEF (RAW) images, highlight **NEF (RAW) recording > Type** in the photo shooting menu and press .

Option	Description
ON  Lossless compressed	NEF images are compressed using a reversible algorithm, reducing file size by about 20–40% with no effect on image quality.
ON  Compressed	NEF images are compressed using a non-reversible algorithm, reducing file size by about 35–55% with almost no effect on image quality.

■ ■ NEF (RAW) Bit Depth

To choose a bit depth for NEF (RAW) images, highlight **NEF (RAW) recording > NEF (RAW) bit depth** in the photo shooting menu and press .

Option	Description
12-bit 12-bit	NEF (RAW) images are recorded at a bit-depth of 12 bits.
14-bit 14-bit	NEF (RAW) images are recorded at a bit depth of 14 bits, producing files larger than those with a bit depth of 12 bits but increasing the color data recorded.

Image Size






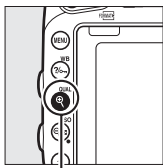
Image size is measured in pixels. Choose from  Large,  Medium, or  Small (note that image size varies depending on the option selected for **Image area**,  110):

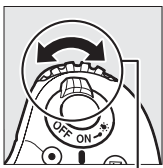
Image area	Option	Size (pixels)	Print size (cm/in.)*
FX (36×24) (FX format)	Large	6016 × 4016	50.9 × 34.0/20.1 × 13.4
	Medium	4512 × 3008	38.2 × 25.5/15.0 × 10.0
	Small	3008 × 2008	25.5 × 17.0/10.0 × 6.7
1.2× (30×20)	Large	5008 × 3336	42.4 × 28.2/16.7 × 11.1
	Medium	3752 × 2504	31.8 × 21.2/12.5 × 8.3
	Small	2504 × 1664	21.2 × 14.1/ 8.3 × 5.5
DX (24×16) (DX format)	Large	3936 × 2624	33.3 × 22.2/13.1 × 8.7
	Medium	2944 × 1968	24.9 × 16.7/ 9.8 × 6.6
	Small	1968 × 1312	16.7 × 11.1/ 6.6 × 4.4

* Approximate size when printed at 300 dpi. Print size in inches equals image size in pixels divided by printer resolution in **dots per inch (dpi)**; 1 inch = approximately 2.54 cm).

Image size can be set by pressing the  (**QUAL**) button and rotating the sub-command dial until the desired setting is displayed in the information display.



 (**QUAL**) button




Sub command dial



Information display

The Photo Shooting Menu

Image size can also be adjusted using the **Image size** option in the photo shooting menu ( 310).

Using Two Memory Cards

When two memory cards are inserted in the camera, you can use the **Role played by card in Slot 2** item in the photo shooting menu to choose the role played by the card in Slot 2. Choose from **Overflow** (the card in Slot 2 is used only when the card in Slot 1 is full), **Backup** (each picture is recorded twice, once to the card in Slot 1 and again to the card in Slot 2), and **RAW Slot 1—JPEG Slot 2** (as for **Backup**, except that the NEF/RAW copies of photos recorded at settings of NEF/RAW + JPEG are recorded only to the card in Slot 1 and the JPEG copies only to the card in Slot 2).

“Backup” and “RAW Slot 1—JPEG Slot 2”

The camera shows the number of exposures remaining on the card with the least amount of memory. Shutter release will be disabled when either card is full.

Recording Movies

When two memory cards are inserted in the camera, the slot used to record movies can be selected using the **Destination** option in the movie shooting menu (📖 319).

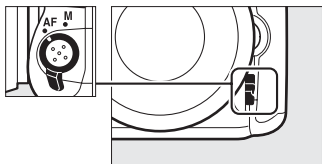
Focus

This section describes the focus options available when photographs are framed in the viewfinder. Focus can be adjusted automatically (see below) or manually (📖 132). The user can also select the focus point for automatic or manual focus (📖 127) or use focus lock to focus to recompose photographs after focusing (📖 129).

Autofocus

To use autofocus, rotate the focus-mode selector to **AF**.

Focus-mode selector

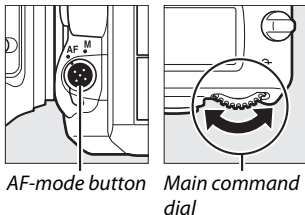


Autofocus Mode

The following autofocus modes can be selected during viewfinder photography:

Mode	Description
AF-A	Auto-servo AF: Camera automatically selects single-servo autofocus if subject is stationary, continuous-servo autofocus if subject is moving.
AF-S	Single-servo AF: For stationary subjects. Focus locks when shutter-release button is pressed halfway. At default settings, shutter can only be released when in-focus indicator (●) is displayed (<i>focus priority</i> ; □ 327).
AF-C	Continuous-servo AF: For moving subjects. Camera focuses continuously while shutter-release button is pressed halfway; if subject moves, camera will engage <i>predictive focus tracking</i> (□ 122) to predict final distance to subject and adjust focus as necessary. At default settings, shutter can be released whether or not subject is in focus (<i>release priority</i> ; □ 326).

Autofocus mode can be selected by pressing the AF-mode button and rotating the main command dial until the desired setting is displayed in the viewfinder or control panel.



Predictive Focus Tracking

In **AF-C** mode or when continuous-servo autofocus is selected in **AF-A** mode, the camera will initiate predictive focus tracking if the subject moves toward or away from the camera while the shutter-release button is pressed halfway. This allows the camera to track focus while attempting to predict where the subject will be when the shutter is released.

See Also

For information on using focus priority in continuous-servo AF, see Custom Setting a1 (**AF-C priority selection**, [□ 326](#)). For information on using release priority in single-servo AF, see Custom Setting a2 (**AF-S priority selection**, [□ 327](#)). See Custom Setting f5 (**Customize command dials**) > **Change main/sub** ([□ 363](#)) for information on using the sub-command dial to choose the focus mode. See page 57 for information on the autofocus options available in live view or during movie recording.

AF-Area Mode

Choose how the focus point is selected during viewfinder photography.

- **Single-point AF:** Select the focus point as described on page 127; the camera will focus on the subject in the selected focus point only. Use with stationary subjects.
- **Dynamic-area AF:** Select the focus point as described on page 127. In **AF-A** and **AF-C** focus modes, the camera will focus based on information from surrounding focus points if the subject briefly leaves the selected point. The number of focus points varies with the mode selected:
 - **9-point dynamic-area AF:** Choose when there is time to compose the photograph or when photographing subjects that are moving predictably (e.g., runners or race cars on a track).
 - **21-point dynamic-area AF:** Choose when photographing subjects that are moving unpredictably (e.g., players at a football game).
 - **51-point dynamic-area AF:** Choose when photographing subjects that are moving quickly and can not be easily framed in the viewfinder (e.g., birds).

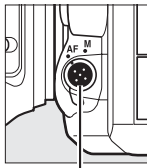
- **3D-tracking:** Select the focus point as described on page 127. In **AF-A** and **AF-C** focus modes, the camera will track subjects that leave the selected focus point and select new focus points as required. Use to quickly compose pictures with subjects that are moving erratically from side to side (e.g., tennis players). If the subject leaves viewfinder, remove your finger from the shutter-release button and recompose the photograph with the subject in the selected focus point.



- **Group-area AF:** The camera focuses using a group of focus points selected by the user, reducing the risk of the camera focusing on the background instead of on the main subject. Choose for subjects that are difficult to photograph using a single focus point. If faces are detected in **AF-S** focus mode, the camera will give priority to portrait subjects.
- **Auto-area AF:** The camera automatically detects the subject and selects the focus point; if a face is detected, the camera will give priority to the portrait subject. The active focus points are highlighted briefly after the camera focuses; in **AF-C** mode or when continuous-servo autofocus is selected in **AF-A** mode, the main focus point remains highlighted after the other focus points have turned off.



AF-area mode can be selected by pressing the AF-mode button and rotating the sub-command dial until the desired setting is displayed in the viewfinder or control panel.



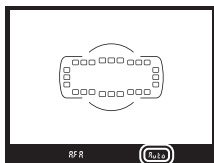
AF-mode button



Sub-command dial



Control panel



Viewfinder

3D-tracking

When the shutter-release button is pressed halfway, the colors in the area surrounding the focus point are stored in the camera.

Consequently 3D-tracking may not produce the desired results with subjects that are similar in color to the background or that occupy a very small area of the frame.

AF-Area Mode

AF-area mode is shown in the control panel and viewfinder.

AF-area mode	Control panel	Viewfinder
Single-point AF	S	S
9-point dynamic-area AF *	d 9	d 9
21-point dynamic-area AF *	d21	d21
51-point dynamic-area AF *	d51	d51
3D-tracking	3d	3d
Group-area AF	G-P	G-P
Auto-area AF	Auto	Auto

*Only active focus point is displayed in the viewfinder. Remaining focus points provide information to assist focus operation.

Manual Focus

Single-point AF is automatically selected when manual focus is used.

See Also

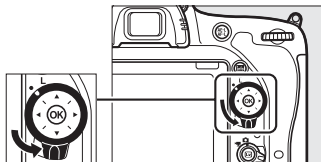
For information on adjusting how long the camera waits before refocusing when an object moves in front of the camera, see Custom Setting a3 (**Focus tracking with lock-on**, □ 328). See Custom Setting a4 (**Focus point illumination**, □ 329) for information on choosing how the focus point is displayed in dynamic-area and group-area AF. See Custom Setting f5 (**Customize command dials**) > **Change main/sub** (□ 363) for information on using the main command dial to choose the AF-area mode. See page 58 for information on the autofocus options available in live view or during movie recording.

Focus Point Selection

The camera offers a choice of 51 focus points that can be used to compose photographs with the main subject positioned almost anywhere in the frame. Follow the steps below to choose the focus point (in group-area AF, you can follow these steps to choose a group of focus points).

1 Rotate the focus selector lock to ●.

This allows the multi selector to be used to select the focus point.



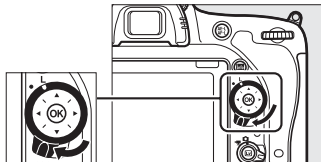
Focus selector lock

2 Select the focus point.

Use the multi selector to select the focus point in the viewfinder while the exposure meters are on. Press **OK** to select the center focus point.









The focus selector lock can be rotated to the locked (L) position following selection to prevent the selected focus point from changing when the multi selector is pressed.



Auto-area AF

The focus point for auto-area AF is selected automatically; manual focus-point selection is not available.

See Also

For information on choosing when the focus point is illuminated, see Custom Setting a5 (**AF point illumination**,  329). For information on setting focus-point selection to “wrap around,” see Custom Setting a6 (**Focus point wrap-around**,  330). For information on choosing the number of focus points that can be selected using the multi selector, see Custom Setting a7 (**Number of focus points**,  330). For information on choosing separate focus points for vertical and horizontal orientations, see Custom Setting a8 (**Store points by orientation**,  331). For information on changing the role of the  button, see Custom Setting f1 (**OK button**,  354).

Focus Lock

Focus lock can be used to change the composition after focusing, making it possible to focus on a subject that will not be in a focus point in the final composition. If the camera is unable to focus using autofocus (☐ 131), focus lock can also be used to recompose the photograph after focusing on another object at the same distance as your original subject. Focus lock is most effective when an option other than auto-area AF is selected for AF-area mode (☐ 123).

1 Focus.

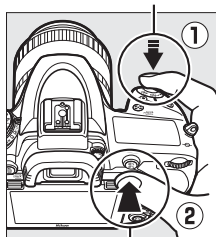
Position the subject in the selected focus point and press the shutter-release button halfway to initiate focus. Check that the in-focus indicator (●) appears in the viewfinder.



2 Lock focus.


AF-A and AF-C focus modes: With the shutter-release button pressed halfway (①), press the ^{AE-L}/_{AF-L} **AE-L/AF-L** button (②) to lock both focus and exposure (an **AE-L** icon will be displayed in the viewfinder). Focus will remain locked while the ^{AE-L}/_{AF-L} **AE-L/AF-L** button is pressed, even if you later remove your finger from the shutter-release button.

Shutter-release button




^{AE-L}/_{AF-L} **AE-L/AF-L** button



AF-S focus mode: Focus locks automatically when the in-focus indicator (●) appears, and remain locked until you remove your finger from the shutter-release button. Focus can also be locked by pressing the  **AE-L/AF-L** button (see above).




3 Recompose the photograph and shoot.

Focus will remain locked between shots if you keep the shutter-release button pressed halfway (**AF-S**) or keep the  **AE-L/AF-L** button pressed, allowing several photographs in succession to be taken at the same focus setting.



Do not change the distance between the camera and the subject while focus lock is in effect. If the subject moves, focus again at the new distance.

See Also

See Custom setting c1 (**Shutter-release button AE-L**,  336) for information on using the shutter-release button to lock exposure, Custom Setting f4 (**Assign AE-L/AF-L button**,  361) for information on choosing the role played by the  **AE-L/AF-L** button.

Getting Good Results with Autofocus

Autofocus does not perform well under the conditions listed below. The shutter release may be disabled if the camera is unable to focus under these conditions, or the in-focus indicator (●) may be displayed and the camera may sound a beep, allowing the shutter to be released even when the subject is not in focus. In these cases, focus manually (📖 132) or use focus lock (📖 129) to focus on another subject at the same distance and then recompose the photograph.



There is little or no contrast between the subject and the background.

Example: Subject is the same color as the background.



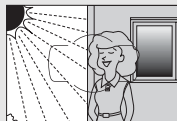
The focus point contains objects at different distances from the camera.

Example: Subject is inside a cage.



The subject is dominated by regular geometric patterns.

Example: Blinds or a row of windows in a skyscraper.



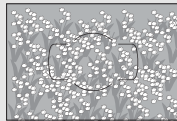
The focus point contains areas of sharply contrasting brightness.

Example: Subject is half in the shade.



Background objects appear larger than the subject.

Example: A building is in the frame behind the subject.



The subject contains many fine details.

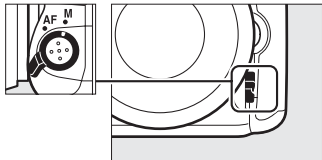
Example: A field of flowers or other subjects that are small or lack variation in brightness.

Manual Focus

Manual focus is available for lenses that do not support autofocus (non-AF NIKKOR lenses) or when the autofocus does not produce the desired results (☞ 131).

- **AF lenses:** Set the lens focus mode switch (if present) and camera focus-mode selector to **M**.

Focus-mode selector



AF Lenses

Do not use AF lenses with the lens focus mode switch set to **M** and the camera focus-mode selector set to **AF**. Failure to observe this precaution could damage the camera or lens. This does not apply to AF-S lenses, which can be used in **M** mode without setting the camera focus-mode selector to **M**.

- **Manual focus lenses:** Focus manually.

To focus manually, adjust the lens focus ring until the image displayed on the clear matte field in the viewfinder is in focus. Photographs can be taken at any time, even when the image is not in focus.



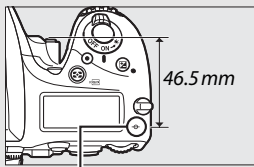
■ The Electronic Rangefinder

The viewfinder focus indicator can be used to confirm whether the subject in the selected focus point is in focus (the focus point can be selected from any of the 51 focus points). After positioning the subject in the selected focus point, press the shutter-release button halfway and rotate the lens focus ring until the in-focus indicator (●) is displayed. Note that with the subjects listed on page 131, the in-focus indicator may sometimes be displayed when the subject is not in focus; confirm focus in the viewfinder before shooting. For information on using the electronic rangefinder with optional AF-S/AF-I teleconverters, see page 430.



🔪 Focal Plane Position


To determine the distance between your subject and the camera, measure from the focal plane mark (⊖) on the camera body. The distance between the lens mounting flange and the focal plane is 46.5 mm (1.83 in.).




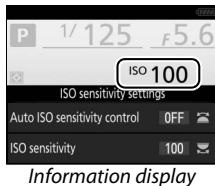
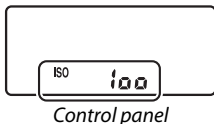
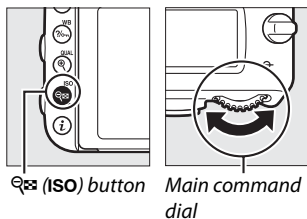
Focal plane mark

ISO Sensitivity

The camera's sensitivity to light can be adjusted according to the amount of light available. Choose from settings that range from ISO 100 to ISO 12800 in steps equivalent to $\frac{1}{3}$ EV. Settings of from about 0.3 to 1 EV below ISO 100 and 0.3 to 2 EV above ISO 12800 are also available for special situations. Auto, scene, and special effect modes also offer an **AUTO** option, which allows the camera to set ISO sensitivity automatically in response to lighting conditions. The higher the ISO sensitivity, the less light needed to make an exposure, allowing higher shutter speeds or smaller apertures.

Modes	Options
P, S, A, M	Lo 1–Lo 0.3; 100–12800 in steps of $\frac{1}{3}$ EV; Hi 0.3–Hi 2
	Auto
Other shooting modes	Auto; Lo 1–Lo 0.3; 100–12800 in steps of $\frac{1}{3}$ EV; Hi 0.3–Hi 2

ISO sensitivity can be adjusted by pressing the  (ISO) button and rotating the main command dial until the desired setting is displayed in the control panel, viewfinder or information display.



ISO Sensitivity

The higher the ISO sensitivity, the less light needed to make an exposure, allowing faster shutter speeds or smaller apertures, but the more likely the image is to be affected by noise (randomly-spaced bright pixels, fog, or lines). Noise is particularly likely at settings between **Hi 0.3** and **Hi 2**.

AUTO

If the mode dial is rotated to **P**, **S**, **A**, or **M** after **AUTO** is selected for ISO sensitivity in another mode, the ISO sensitivity last selected in **P**, **S**, **A**, or **M** mode will be restored.

Hi 0.3–Hi 2

The settings **Hi 0.3** through **Hi 2** correspond to ISO sensitivities 0.3–2 EV over ISO 12800 (ISO 16000–51200 equivalent).


Lo 0.3–Lo 1

The settings **Lo 0.3** through **Lo 1** correspond to ISO sensitivities 0.3–1 EV below ISO 100 (ISO 80–50 equivalent). Use for larger apertures when lighting is bright. Contrast is slightly higher than normal; in most cases, ISO sensitivities of ISO 100 or above are recommended.

The Shooting Menus

ISO sensitivity can also be adjusted from the photo and movie shooting menus. Choose **ISO sensitivity settings** in photo shooting menu to adjust settings for viewfinder and live view photography (☞ 310) and **Movie ISO sensitivity settings** in the movie shooting menu to adjust settings for movie live view (☞ 322).

See Also

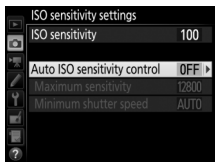
For information on choosing the ISO sensitivity step size, see Custom Setting b1 (**ISO sensitivity step value**; ☞ 333). For information on adjusting ISO sensitivity without using the  (**ISO**) button, see Custom Setting d8 (**Easy ISO**; ☞ 341). For information on using the **High ISO NR** option in the shooting menus to reduce noise at high ISO sensitivities, see page 317.

Auto ISO Sensitivity Control

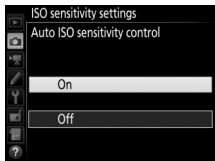
(P, S, A, and M Modes Only)

If **On** is selected for **ISO sensitivity settings > Auto ISO sensitivity control** in the photo shooting menu, ISO sensitivity will automatically be adjusted if optimal exposure can not be achieved at the value selected by the user (ISO sensitivity is adjusted appropriately when the flash is used).

- 1 Select Auto ISO sensitivity control.**
Select **ISO sensitivity settings** in the photo shooting menu, highlight **Auto ISO sensitivity control** and press \odot .

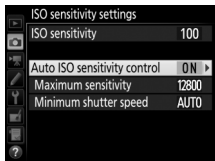


- 2 Select On.**
Highlight **On** and press \odot (if **Off** is selected, ISO sensitivity will remain fixed at the value selected by the user).

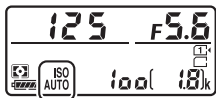


3 Adjust settings.


The maximum value for auto ISO sensitivity can be selected using **Maximum sensitivity** (note that if the ISO sensitivity selected by the user is higher than that chosen for **Maximum sensitivity**, the value selected by the user will be used instead). In modes **P** and **A**, sensitivity will only be adjusted if underexposure would result at the shutter speed selected for **Minimum shutter speed** ($1/2000$ –30 s, or **Auto**; in modes **S** and **M**, ISO sensitivity will be adjusted for optimal exposure at the shutter speed selected by the user). If **Auto** is selected, the camera will choose the minimum shutter speed based on the focal length of the lens. Press **OK** to exit when settings are complete.





When **On** is selected, the viewfinder and control panel show **ISO AUTO**. When sensitivity is altered from the value selected by the user, these indicators flash and the altered value is shown in viewfinder.




Minimum Shutter Speed

Auto shutter-speed selection can be fine-tuned by highlighting **Auto** and pressing : for example, values faster than those usually selected automatically can be used with telephoto lenses to reduce blur. Note, however, that **Auto** functions only with CPU lenses; if a non-CPU lens is used without lens data, minimum shutter speed is fixed at $\frac{1}{30}$ s. Shutter speeds may drop below the selected minimum if optimum exposure can not be achieved at the ISO sensitivity chosen for **Maximum sensitivity**.

Auto ISO Sensitivity Control

Noise (randomly-spaced bright pixels, fog, or lines) is more likely at higher sensitivities. Use the **High ISO NR** option in the shooting menus to reduce noise (see page 317). When a flash is used, minimum shutter speed will be set to the value selected for **Minimum shutter speed** unless this value is faster than Custom Setting e1 (**Flash sync speed**,  345) or slower than Custom Setting e2 (**Flash shutter speed**,  346), in which case the value selected for Custom Setting e2 will be used instead. Note that ISO sensitivity may be raised automatically when auto ISO sensitivity control is used in combination with slow sync flash modes (available with the built-in flash and the optional flash units listed on page 433), possibly preventing the camera from selecting slow shutter speeds.

Enabling and Disabling Auto ISO Sensitivity Control





You can turn auto ISO sensitivity control on or off by pressing the  (**ISO**) button and rotating the sub-command dial. **ISO AUTO** is displayed when auto ISO sensitivity control is on.


Exposure

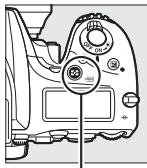
Metering


(P, S, A, and M Modes Only)

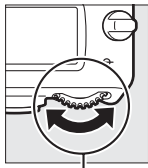
Choose how the camera sets exposure in **P**, **S**, **A**, and **M** modes (in other modes, the camera selects the metering method automatically).

Option	Description
	Matrix: Produces natural results in most situations. Camera meters a wide area of the frame and set exposure according to tone distribution, color, composition, and, with type G, E, or D lenses (□ 429), distance information (3D color matrix metering III; with other CPU lenses, camera uses color matrix metering III, which does not include 3D distance information).
	Center-weighted: Camera meters entire frame but assigns greatest weight to center area (if CPU lens is attached, size of area can be selected using Custom Setting b5, Center-weighted area , □ 335; if non-CPU lens is attached, area is equivalent to circle 12 mm in diameter). Classic meter for portraits; recommended when using filters with an exposure factor (filter factor) over 1×.
	Spot: Camera meters circle 4 mm (0.16 in.) in diameter (approximately 1.5% of frame). Circle is centered on current focus point, making it possible to meter off-center subjects (if non-CPU lens is used or if auto-area AF is in effect, camera will meter center focus point). Ensures that subject will be correctly exposed, even when background is much brighter or darker.
	Highlight-weighted: Camera assigns greatest weight to highlights. Use to reduce loss of detail in highlights, for example when photographing spotlight performers on a stage.

To choose a metering option, press the  (FORMAT) button and rotate the main command dial until the desired setting is displayed in the viewfinder and control panel.



 button



Main command dial




Control panel





Viewfinder

Non-CPU Lens Data

Specifying the focal length and maximum aperture of non-CPU lenses using the **Non-CPU lens data** option in the setup menu ( 236) allows the camera to use color matrix metering when matrix is selected and improves the accuracy of center-weighted and spot metering. Center-weighted metering will be used if highlight-weighted metering is selected with non-CPU lenses or if matrix metering is selected with non-CPU lenses for which lens data have not been supplied. Note that center-weighted metering may also be used if highlight-weighted metering is selected with certain CPU lenses (AI-P NIKKOR lenses and AF lenses that are not of type G, E, or D).

See Also

See Custom Setting b4 (**Matrix metering**,  335) for information on choosing whether matrix metering uses face detection. For information on making separate adjustments to optimal exposure for each metering method, see Custom Setting b6 (**Fine-tune optimal exposure**,  336).

Autoexposure Lock

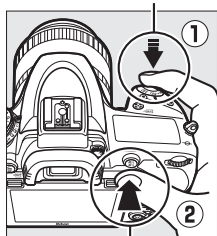
Use autoexposure lock to recompose photographs after using center-weighted metering and spot metering (☞ 139) to meter exposure.

1 Lock exposure.

Position the subject in the selected focus point and press the shutter-release button halfway. With the shutter-release button pressed halfway and the subject positioned in the focus point, press the AE-L/AF-L **AE-L/AF-L** button to lock focus and exposure (if you are using autofocus, confirm that the in-focus indicator (●) appears in the viewfinder).

While exposure lock is in effect, an **AE-L** indicator will appear in the viewfinder.

Shutter-release button



AE-L/AF-L button



2 Recompose the photograph.

Keeping the AE-L/AF-L **AE-L/AF-L** button pressed, recompose the photograph and shoot.




Metered Area

In spot metering, exposure will be locked at the value metered in a 4-mm (0.16 in.) circle centered on the selected focus point. In center-weighted metering, exposure will be locked at the value metered in a 12-mm circle in the center of the viewfinder.




Adjusting Shutter Speed and Aperture

While exposure lock is in effect, the following settings can be adjusted without altering the metered value for exposure:


Mode	Setting
P	Shutter speed and aperture (flexible program;  89)
S	Shutter speed
A	Aperture


The new values can be confirmed in the viewfinder and control panel. Note that metering can not be changed while exposure lock is in effect.

See Also

If **On** is selected for Custom Setting c1 (**Shutter-release button AE-L**,  336), exposure will lock when the shutter-release button is pressed halfway. For information on changing the role of the  **AE-L/AF-L** button, see Custom Setting f4 (**Assign AE-L/AF-L button**,  361).

Exposure Compensation

(P, S, A, M, SCENE, and  Modes Only)

Exposure compensation is used to alter exposure from the value suggested by the camera, making pictures brighter or darker. It is most effective when used with center-weighted or spot metering ( 139). Choose from values between -5 EV (underexposure) and $+5$ EV (overexposure) in increments of $\frac{1}{3}$ EV. In general, positive values make the subject brighter while negative values make it darker.




-1 EV

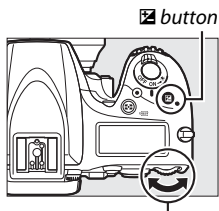


No exposure
compensation



$+1$ EV


To choose a value for exposure compensation, press the  button and rotate the main command dial until the desired value is displayed in the control panel or viewfinder.



Main command dial

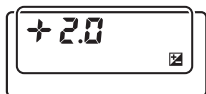


± 0 EV





( button pressed)




-0.3 ($-\frac{1}{3}$) EV



$+2.0$ EV

At values other than ± 0.0 , the 0 at the center of the exposure indicators will flash (modes **P**, **S**, **A**, **SCENE**, and ) and a  icon will be displayed in the control panel and viewfinder after you release the  button. The current value for exposure compensation can be confirmed in the exposure indicator by pressing the  button.







Normal exposure can be restored by setting exposure compensation to ± 0 (adjustments to exposure compensation in **SCENE** and  modes will be reset when another mode is selected). Exposure compensation is not reset when the camera is turned off.

Mode M

In mode **M**, exposure compensation affects only the exposure indicator; shutter speed and aperture do not change.








See Also

For information on choosing the size of the increments available for exposure compensation, see Custom Setting b2 (**EV steps for exposure cntrl**,  333). For information on making adjustments to exposure compensation without pressing the  button, see Custom Setting b3 (**Easy exposure compensation**,  334). For information on restricting the effects of exposure compensation to the background when using a flash for foreground lighting, see Custom Setting e4 (**Exposure comp. for flash**,  353). For information on automatically varying exposure, flash level, white balance, or Active D-Lighting, see page 202.


White Balance

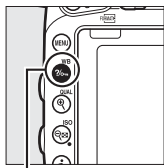
(P, S, A, and M Modes Only)


White balance ensures that colors are unaffected by the color of the light source. In modes other than **P**, **S**, **A**, and **M**, white balance is set automatically by the camera. Auto white balance is recommended for most light sources in **P**, **S**, **A**, and **M** modes, but other values can be selected if necessary according to the type of source:

	Option	Color temp.*
AUTO	Auto	3500–8000 K
	Normal	
	Keep warm lighting colors	
	Incandescent	3000 K
	Fluorescent	
	Sodium-vapor lamps	2700 K
	Warm-white fluorescent	3000 K
	White fluorescent	3700 K
	Cool-white fluorescent	4200 K
	Day white fluorescent	5000 K
	Daylight fluorescent	6500 K
High temp. mercury-vapor	7200 K	
	Direct sunlight	5200 K
	Flash	5400 K
	Cloudy	6000 K
	Shade	8000 K
	Choose color temp. (☐ 152)	2500–10,000 K
PRE	Preset manual (☐ 155)	—

* All values are approximate and do not reflect fine-tuning (if applicable).

White balance is set by pressing the  (WB) button and rotating the main command dial until the desired setting is displayed in the information display.



 (WB) button




Main command dial



Information display

The Shooting Menus

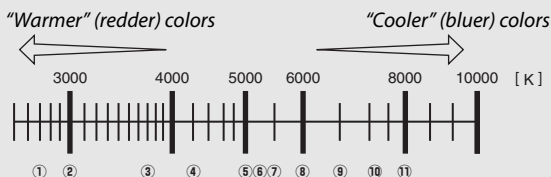
White balance can also be adjusted using the **White balance** option in either of the shooting menus (□ 310, 321), which also can be used to fine-tune white balance (□ 149) or measure a value for preset manual white balance (□ 155). The **Auto** option in the **White balance** menu offers a choice of **Normal** and **Keep warm lighting colors**, which preserves the warm colors produced by incandescent lighting, while the  **Fluorescent** option can be used to select the light source from the bulb types. The item in the movie shooting menu offers a **Same as photo settings** option that sets the white balance for movies to the same as that used for photographs.













Studio Flash Lighting

Auto white balance may not produce the desired results with large studio flash units. Use preset manual white balance or set white balance to **Flash** and use fine tuning to adjust white balance.

Color Temperature



The perceived color of a light source varies with the viewer and other conditions. Color temperature is an objective measure of the color of a light source, defined with reference to the temperature to which an object would have to be heated to radiate light in the same wavelengths. While light sources with a color temperature in the neighborhood of 5000–5500 K appear white, light sources with a lower color temperature, such as incandescent light bulbs, appear slightly yellow or red. Light sources with a higher color temperature appear tinged with blue.



- | | |
|---|---|
| ① |  (sodium-vapor lamps): 2700 K |
| ② |  (incandescent)/  (warm-white fluorescent.): 3000 K |
| ③ |  (white fluorescent): 3700 K |
| ④ |  (cool-white fluorescent): 4200 K |
| ⑤ |  (day white fluorescent): 5000 K |
| ⑥ |  (direct sunlight): 5200 K |
| ⑦ |  (flash): 5400 K |
| ⑧ |  (cloudy): 6000 K |
| ⑨ |  (daylight fluorescent): 6500 K |
| ⑩ |  (high temp. mercury-vapor): 7200 K |
| ⑪ |  (shade): 8000 K |

Note: All figures are approximate.

 **See Also**

When **WB bracketing** is selected for Custom Setting e6 (**Auto bracketing set**,  353), the camera will create several images each time the shutter is released. White balance will be varied with each image, “bracketing” the value currently selected for white balance ( 208).

Fine-Tuning White Balance

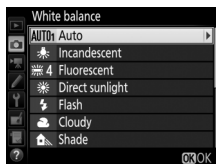
At settings other than **☑ (Choose color temp.)**, white balance can be “fine-tuned” to compensate for variations in the color of the light source or to introduce a deliberate color cast into an image.

■ ■ The White Balance Menu

To fine-tune white balance from the shooting menus, select **White balance** and follow the steps below.

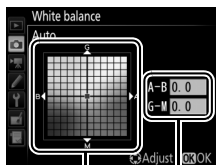
1 Display fine-tuning options.

Highlight a white balance option and press **⏏** (if a sub-menu is displayed, select the desired option and press **⏏** again to display fine-tuning options; for information on fine-tuning preset manual white balance, see page 164).



2 Fine tune white balance.

Use the multi selector to fine-tune white balance. White balance can be fine-tuned on the amber (A)–blue (B) axis in steps of 0.5 and the green (G)–magenta (M) axis in steps of 0.25. The horizontal (amber–blue) axis corresponds to color temperature, while the vertical (green–magenta) axis has the similar effects to the corresponding color compensation (CC) filters. The horizontal axis is ruled in increments equivalent to about 5 mired, the vertical axis in increments of about 0.05 diffuse density units.



Coordinates

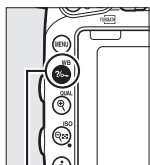
Adjustment

3 Press **OK**.

Press **OK** to save settings and return to the shooting menus.

■ The **WB** Button

At settings other than **☑ (Choose color temp.)** and **PRE (Preset manual)**, the **WB** button can be used to fine-tune white balance on the amber (A)–blue (B) axis (☞ 149; to fine-tune white balance when **PRE** is selected, use the shooting menus as described on page 164). Press the **WB** button and rotate the sub-command dial to fine-tune white balance in steps of 0.5 (with each full increment equivalent to about 5 mired) until the desired value is displayed in the control panel and information display. Rotating the sub-command dial to the left increases the amount of amber (A). Rotating the sub-command dial to the right increases the amount of blue (B).



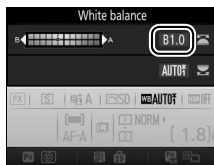
WB button



Sub-command dial




Control panel



Information display

White Balance Fine-Tuning

If white balance has been fine-tuned, an asterisk (“*”) will be displayed in the information display. Note that the colors on the fine-tuning axes are relative, not absolute. For example, moving the cursor to **B** (blue) when a “warm” setting such as  (incandescent) is selected for white balance will make photographs slightly “colder” but will not actually make them blue.



Information display

“Mired”

Any given change in color temperature produces a greater difference in color at low color temperatures than it would at higher color temperatures. For example, a change of 1000 K produces a much greater change in color at 3000 K than at 6000 K. Mired, calculated by multiplying the inverse of the color temperature by 10^6 , is a measure of color temperature that takes such variation into account, and as such is the unit used in color-temperature compensation filters. E.g.:

- 4000 K–3000 K (a difference of 1000 K)=83 mired
- 7000 K–6000 K (a difference of 1000 K)=24 mired

Choosing a Color Temperature

Follow the steps below to choose a color temperature when **☑ (Choose color temp.)** is selected for white balance.

☑ Choose Color Temperature

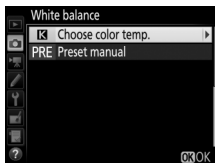
Note that the desired results will not be obtained with flash or fluorescent lighting. Choose **⚡ (Flash)** or **☀ (Fluorescent)** for these sources. With other light sources, take a test shot to determine if the selected value is appropriate.

■ The White Balance Menu

Color temperature can be selected using the **White balance** options in the shooting menus. Enter values for the amber–blue and green–magenta axes (☞ 149) as described below.

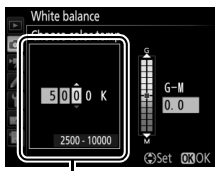
1 Select Choose color temp.

Select **White balance** in either of the shooting menus, then highlight **Choose color temp.** and press **▶**.







2 Select a value for amber-blue.

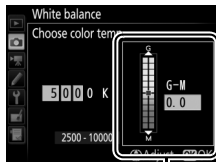
Press **◀** or **▶** to highlight digits and press **▲** or **▼** to change.



Value for amber (A)-
blue (B) axis


3 Select a value for green-magenta.

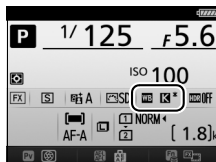
Press  or  to highlight the G (green) or M (magenta) axis and press  or  to select a value.



*Value for green (G)-
magenta (M) axis*

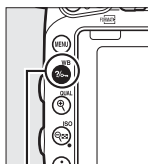
4 Press .

Press  to save changes and return to the shooting menus. If a value other than 0 is selected for the green (G)-magenta (M) axis, an asterisk ("*****") will be displayed in the information display.



■ The ?/0-m (WB) Button

When [C] (Choose color temp.) is selected, the ?/0-m (WB) button can be used to select the color temperature, although only for the amber (A)–blue (B) axis. Press the ?/0-m (WB) button and rotate the sub-command dial until the desired value is displayed in the control panel and information display (adjustments are made in mireds; [M] 151). To enter a color temperature directly, press the ?/0-m (WB) button and press [L] or [R] to highlight a digit and press [U] or [D] to change.



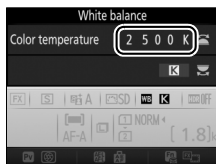
?/0-m (WB) button



Sub-command dial



Control panel



Information display

Preset Manual

Preset manual is used to record and recall custom white balance settings for shooting under mixed lighting or to compensate for light sources with a strong color cast. The camera can store up to six values for preset manual white balance in presets d-1 through d-6. Two methods are available for setting preset manual white balance:

Method	Description
Direct measurement	Neutral gray or white object is placed under lighting that will be used in final photo and white balance measured by camera (□ 155). In live view photography and movie live view (□ 54, 66), white balance can be measured in a selected area of the frame (spot white balance, □ 159).
Copy from existing photograph	White balance is copied from photo on memory card (□ 162).

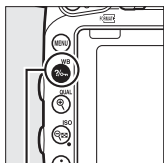
Viewfinder Photography

1 Light a reference object.

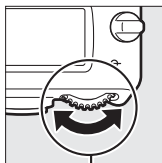
Place a neutral gray or white object under the lighting that will be used in the final photograph. In studio settings, a standard gray panel can be used as a reference object. Note that exposure is automatically increased by 1 EV when measuring white balance; in mode **M**, adjust exposure so that the exposure indicator shows ± 0 (□ 94).

2 Set white balance to PRE (Preset manual).

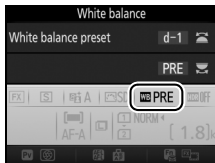
Press the **WB** button and rotate the main command dial until **PRE** is displayed in the information display.



WB button



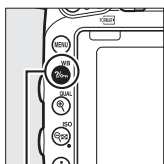
Main command dial



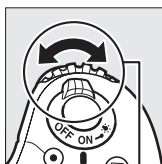
Information display

3 Select a preset.

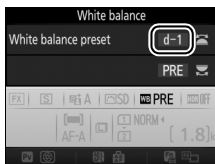
Press the **WB** button and rotate the sub-command dial until the desired white balance preset (d-1 to d-6) is displayed in the information display.



WB button




Sub-command dial



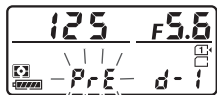
Information display

Measuring Preset Manual White Balance (Viewfinder Photography)

Preset manual white balance can not be measured while you are shooting an HDR photograph (□ 177) or multiple exposure (□ 216), or when **Record movies** is selected for Custom Setting g4 (**Assign shutter button**, □ 373) and the live view selector is rotated to .

4 Select direct measurement mode.

Release the $\frac{1}{60}$ (WB) button briefly and then press the button until P_rE starts to flash in the control panel and viewfinder. The displays will flash for about six seconds.



Control panel



Viewfinder

5 Measure white balance.

Before the indicators stop flashing, frame the reference object so that it fills the viewfinder and press the shutter-release button all the way down. The camera will measure a value for white balance and store it in the preset selected in Step 3. No photograph will be recorded; white balance can be measured accurately even when the camera is not in focus.

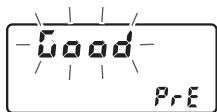


Protected Presets

If the current preset is protected (□ 164), P_rE or Prt will flash in the control panel, viewfinder, and information display if you attempt to measure a new value.

6 Check the results.

If the camera was able to measure a value for white balance, **Good** will flash in the control panel for about six seconds, while the viewfinder will show a flashing **ūd**.

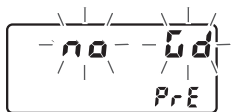


Control panel



Viewfinder

If lighting is too dark or too bright, the camera may be unable to measure white balance. A flashing **no ūd** will appear in the control panel and viewfinder for about six seconds. Press the shutter-release button halfway to return to Step 5 and measure white balance again.




Control panel



Viewfinder

Direct Measurement Mode

If no operations are performed during viewfinder photography while the displays are flashing, direct measurement mode will end in the time selected for Custom Setting c2 (**Standby timer**,  336).

Selecting a Preset

Selecting **Preset manual** for the **White balance** option in either of the shooting menus displays the dialog shown at right; highlight a preset and press **OK**. If no value currently exists for the selected preset, white balance will be set to 5200 K, the same as **Direct sunlight**.

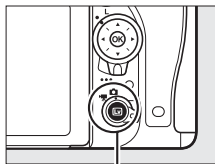


Live View (Spot White Balance)

In live view photography and movie live view (📖 54, 66), white balance can be measured in a selected area of the frame, eliminating the need to prepare a reference object or change lenses during telephoto photography.

1 Press the **Lv button.**

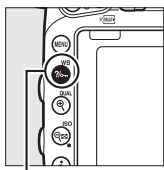
The mirror will be raised and the view through the lens will be displayed in the camera monitor.



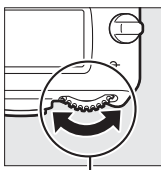
Lv button

2 Set white balance to PRE (Preset manual).

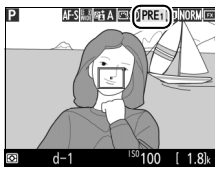
Press the **WB** button and rotate the main command dial until **PRE** is displayed in the monitor.



WB button



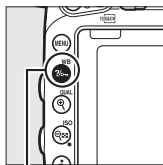
Main command
dial



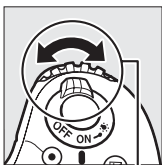
Monitor

3 Select a preset.

Press the **WB** button and rotate the sub-command dial until the desired white balance preset (d-1 to d-6) is displayed in the monitor.



WB button



Sub-command
dial



Monitor

4 Select direct measurement mode.

Release the **WB** button briefly and then press the button until the **PRE** icon in the monitor starts to flash. A spot white balance target (□) will be displayed at the selected focus point.



Monitor

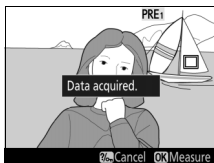
5 Position the target over a white or grey area.

While **PRE** flashes in the display, use the multi selector to position the □ over a white or grey area of the subject. To zoom the area around the target in for more precise positioning, press the **QUAL** button.

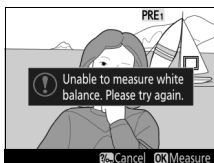


6 Measure white balance.

Press **OK** or press the shutter-release button all the way down to measure white balance. The time available to measure white balance is that selected for Custom Setting c4 (**Monitor off delay**) > **Live view** (☞ 337).



If the camera is unable to measure white balance, the message shown at right will be displayed. Choose a new white balance target and repeat the process from Step 5.



7 Exit direct measurement mode.

Press the **WB** button to exit direct measurement mode.

When **Preset manual** is selected for **White balance** in either of the shooting menus, the position of the target used to measure preset manual white balance will be displayed on presets recorded during live view photography and movie live view.



Measuring Preset Manual White Balance (Live View)


Preset manual white balance can not be measured when **Record movies** is selected for Custom Setting g4 (**Assign shutter button**, ☞ 373) and the live view selector is rotated to **Movie**. Preset manual white balance can not be set while an HDR exposure is in progress (☞ 177).

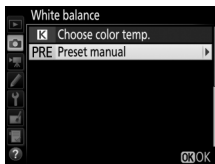
Managing Presets

■ Copying White Balance from a Photograph


Follow the steps below to copy a value for white balance from an existing photograph to a selected preset.

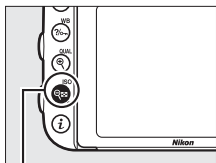
1 Select Preset manual.


Select **White balance** in either of the shooting menus, then highlight **Preset manual** and press .



2 Select a destination.

Highlight the destination preset (d-1 to d-6) and press  (ISO).

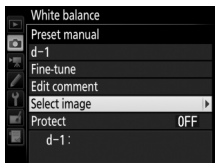


 (ISO) button

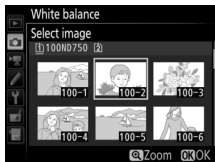


3 Choose Select image.

Highlight **Select image** and press .



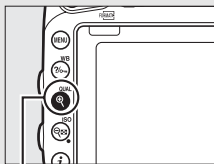
- 4 Highlight a source image.**
Highlight the source image.



- 5 Copy white balance.**
Press **OK** to copy the white balance value for the highlighted photograph to the selected preset. If the highlighted photograph has a comment (📖 384), the comment will be copied to the comment for the selected preset.

Choosing a Source Image



To view the image highlighted in Step 4 full frame, press and hold the **QUAL** button.

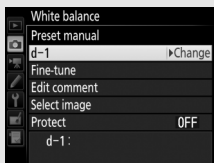


QUAL button



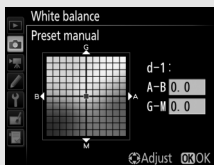
Choosing a White Balance Preset

Press  to highlight the current white balance preset (d-1–d-6) and press  to select another preset.



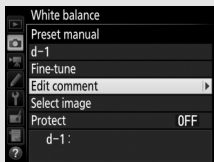
Fine-Tuning Preset Manual White Balance

The selected preset can be fine-tuned by selecting **Fine-tune** and adjusting white balance as described on page 149.




Edit Comment

To enter a descriptive comment of up to 36 characters for the current white-balance preset, select **Edit comment** in the preset manual white balance menu and enter a comment as described on page 171.



Protect

To protect the current white-balance preset, select **Protect** in the preset manual white balance menu, then highlight **On** and press . Protected presets can not be modified and the **Fine-tune** and **Edit comment** options can not be used.

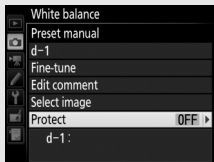


Image Enhancement








Picture Controls

(P, S, A, and M Modes Only)

In **P**, **S**, **A**, and **M** modes, your choice of Picture Control determines how pictures are processed (in other modes, the camera selects a Picture Control automatically).


Selecting a Picture Control

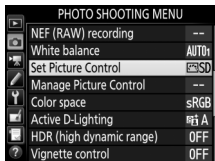
Choose a Picture Control according to the subject or type of scene.


Option	Description
 SD Standard	Standard processing for balanced results. Recommended for most situations.
 NL Neutral	Minimal processing for natural results. Choose for photographs that will later be processed or retouched.
 VI Vivid	Pictures are enhanced for a vivid, photoprint effect. Choose for photographs that emphasize primary colors.
 MC Monochrome	Take monochrome photographs.
 PT Portrait	Process portraits for skin with natural texture and a rounded feel.
 LS Landscape	Produces vibrant landscapes and cityscapes.
 FL Flat	Details are preserved over a wide tone range, from highlights to shadows. Choose for photographs that will later be extensively processed or retouched.

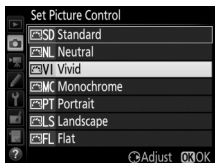
The Movie Shooting Menu

The **Set Picture Control** option in the movie shooting menu also offers a **Same as photo settings** option that sets the Picture Control for movies to the same as that used for photographs.

- 1 Select Set Picture Control.**
Highlight **Set Picture Control** in either of the shooting menus and press .




- 2 Select a Picture Control.**
Highlight a Picture Control and press .



Custom Picture Controls

Custom Picture Controls are created through modifications to existing Picture Controls using the **Manage Picture Control** option in the shooting menus (□ 170). Custom Picture Controls can be saved to a memory card for sharing among other cameras of the same model and compatible software (□ 173).

The Picture Control Indicator

The current Picture Control is shown in the information display when the  button is pressed.



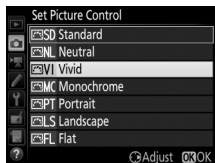
Picture Control indicator

Modifying Picture Controls

Existing preset or custom Picture Controls (📖 170) can be modified to suit the scene or the user's creative intent. Choose a balanced combination of settings using **Quick adjust**, or make manual adjustments to individual settings.

1 Select a Picture Control.

Highlight the desired Picture Control in the Picture Control list (📖 165) and press **OK**.



2 Adjust settings.

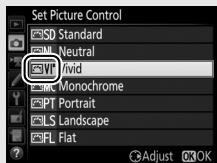
Press **Up** or **Down** to highlight the desired setting and press **Left** or **Right** to choose a value in increments of 1, or rotate the sub-command dial to choose a value in increments of 0.25 (📖 168). Repeat this step until all settings have been adjusted, or select a preset combination of settings by using the multi selector to choose **Quick adjust**. Default settings can be restored by pressing the **Reset** (🗑️) button.



3 Press **OK**.

📌 Modifications to Original Picture Controls

Picture Controls that have been modified from default settings are indicated by an asterisk ("*").



Picture Control Settings

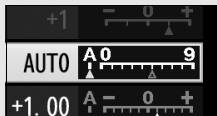
Option	Description	
Quick adjust	Mute or heighten the effect of the selected Picture Control (note that this resets all manual adjustments). Not available with Neutral, Monochrome, Flat , or custom Picture Controls (□ 170).	
Manual adjustments (all Picture Controls)	Sharpening	Control the sharpness of outlines. Select A to adjust sharpening automatically according to the type of scene.
	Clarity	Adjust clarity manually or select A to let the camera adjust clarity automatically. Depending on the scene, shadows may appear around bright objects or halos may appear around dark objects at some settings. Clarity is not applied to movies.
	Contrast	Adjust contrast manually or select A to let the camera adjust contrast automatically.
	Brightness	Raise or lower brightness without loss of detail in highlights or shadows.
Manual adjustments (non-monochrome only)	Saturation	Control the vividness of colors. Select A to adjust saturation automatically according to the type of scene.
	Hue	Adjust hue.
Manual adjustments (monochrome only)	Filter effects	Simulate the effect of color filters on monochrome photographs (□ 169).
	Toning	Choose the tint used in monochrome photographs (□ 170).

☑ "A" (Auto)

Results for auto sharpening, clarity, contrast, and saturation vary with exposure and the position of the subject in the frame. Use a type G, E, or D lens for best results.

☑ Switching Between Manual and Auto

Press the **Q** (QUAL) button to switch back and forth between manual and auto (A) settings for sharpening, clarity, contrast, and saturation.

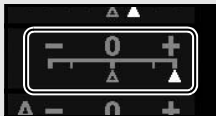


☑ Custom Picture Controls

The options available with custom Picture Controls are the same as those on which the custom Picture Control was based.

☑ Previous Settings

The **Δ** indicator under the value display in the Picture Control setting menu indicates the previous value for the setting. Use this as a reference when adjusting settings.






☑ Filter Effects (Monochrome Only)

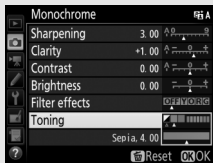
The options in this menu simulate the effect of color filters on monochrome photographs. The following filter effects are available:

Option	Description
Y Yellow	Enhances contrast. Can be used to tone down the brightness of the sky in landscape photographs.
O Orange	
R Red	Orange produces more contrast than yellow, red more contrast than orange.
G Green	Softens skin tones. Can be used for portraits.

Note that the effects achieved with **Filter effects** are more pronounced than those produced by physical glass filters.

Toning (Monochrome Only)


Pressing  when **Toning** is selected displays saturation options. Press  or  to adjust saturation in increments of 1, or rotate the sub-command dial to choose a value in increments of 0.25. Saturation control is not available when **B&W** (black-and-white) is selected.



Creating Custom Picture Controls

The Picture Controls supplied with the camera can be modified and saved as custom Picture Controls.

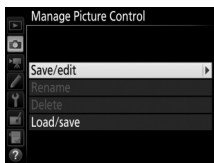
1 Select Manage Picture Control.

Highlight **Manage Picture Control** in either of the shooting menus and press .





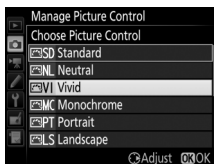
2 Select Save/edit.

Highlight **Save/edit** and press .





3 Select a Picture Control.

Highlight an existing Picture Control and press , or press  to proceed to Step 5 to save a copy of the highlighted Picture Control without further modification.




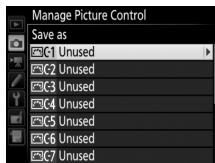
4 Edit the selected Picture Control.

See page 168 for more information. To abandon any changes and start over from default settings, press the  (FORMAT) button. Press  when settings are complete.








5 Select a destination.

Choose a destination for the custom Picture Control (C-1 through C-9) and press .



6 Name the Picture Control.

The text-entry dialog shown at right will be displayed. By default, new Picture Controls are named by adding a two-digit number (assigned automatically) to the name of the existing Picture Control; to use the default name, proceed to Step 7. To move the cursor in the name area, hold the  (ISO) button and press  or . To enter a new letter at the current cursor position, use the multi selector to highlight the desired character in the keyboard area and press . To delete the character at the current cursor position, press the  (FORMAT) button.

Keyboard area

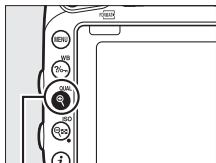


Name area

Custom Picture Control names can be up to nineteen characters long. Any characters after the nineteenth will be deleted.

7 Press **QUAL**.

Press the **QUAL** button to save changes and exit. The new Picture Control will appear in the Picture Control list.



QUAL button



Manage Picture Control > Rename

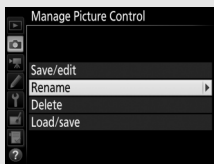
Custom Picture Controls can be renamed at any time using the **Rename** option in the **Manage Picture Control** menu.

Manage Picture Control > Delete

The **Delete** option in the **Manage Picture Control** menu can be used to delete selected custom Picture Controls when they are no longer needed.

The Original Picture Control Icon

The original preset Picture Control on which the custom Picture Control is based is indicated by an icon in the top right corner of the edit display.



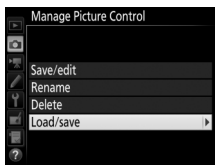
Original Picture Control icon



Sharing Custom Picture Controls

Use the **Load/save** option in the **Manage Picture Control** menu to copy custom Picture Controls to and from memory cards. Custom Picture Controls can be created on a computer using Picture Control Utility 2, a utility launched from ViewNX 2 (supplied) or Capture NX-D (☐ 268), then saved to a memory card and copied to the camera. Custom Picture Controls created on the camera can be copied to a memory card for use in other D750s. Once the copies are no longer needed, they can be deleted using the **Delete from card** option.

To copy custom Picture Controls to or from the memory card, or to delete custom Picture Controls from the memory card, highlight **Load/save** in the **Manage Picture Control** menu and press **▶**. The following options will be displayed:



- **Copy to camera:** Copy custom Picture Controls from the memory card to custom Picture Controls C-1 through C-9 on the camera and name them as desired.
- **Delete from card:** Delete selected custom Picture Controls from the memory card. The confirmation dialog shown at right will be displayed before a Picture Control is deleted; to delete the selected Picture Control, highlight **Yes** and press **OK**.
- **Copy to card:** Copy a custom Picture Control (C-1 through C-9) from the camera to a selected destination (1 through 99) on the memory card.



Saving Custom Picture Controls

Up to 99 custom Picture Controls can be stored on the memory card at any one time. The memory card can only be used to store user-created custom Picture Controls. The preset Picture Controls supplied with the camera (📖 165) can not be copied to the memory card, renamed, or deleted.

The options in the **Manage Picture Control** menu apply only to the memory card in Slot 1. Custom Picture Controls can not be deleted from or copied to or from the card in Slot 2.

Preserving Detail in Highlights and Shadows

Active D-Lighting

(P, S, A, and M Modes Only)

Active D-Lighting preserves details in highlights and shadows, creating photographs with natural contrast. Use for high contrast scenes, for example when photographing brightly lit outdoor scenery through a door or window or taking pictures of shaded subjects on a sunny day. It is most effective when used with matrix metering (☐ 139).



Active D-Lighting off




Active D-Lighting: 暗 A Auto

“Active D-Lighting” Versus “D-Lighting”

The **Active D-Lighting** option in the photo shooting menu adjusts exposure before shooting to optimize the dynamic range, while the **D-Lighting** option in the retouch menu (☐ 397) brightens shadows in images after shooting.





To use Active D-Lighting:

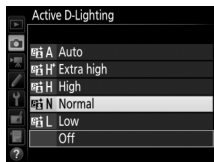
1 Select Active D-Lighting.

Highlight **Active D-Lighting** in the photo shooting menu and press .



2 Choose an option.



Highlight the desired option and press . If  **Auto** is selected, the camera will automatically adjust Active D-Lighting according to shooting conditions (in mode **M**, however,  **Auto** is equivalent to  **Normal**).



Active D-Lighting

Noise (randomly-spaced bright pixels, fog, or lines) may appear in photographs taken with Active D-Lighting. With some subjects, you may notice uneven shading, shadows around bright objects, or halos around dark objects. Active D-Lighting can not be used at ISO sensitivities of Hi 0.3 or above.

See Also

When **ADL bracketing** is selected for Custom Setting e6 (**Auto bracketing set**,  353), the camera varies Active D-Lighting over a series of shots ( 212). For information on using the **Fn** button and main command dial to select an Active D-Lighting option, see page 360.

High Dynamic Range (HDR)

Used with high-contrast subjects, **High Dynamic Range (HDR)** preserves details in highlights and shadows by combining two shots taken at different exposures. HDR is most effective when used with matrix metering (□ 139; with spot or center-weighted metering and a non-CPU lens, a strength of **Auto** is equivalent to **Normal**). It can not be used to record NEF (RAW) images. Flash lighting, bracketing (□ 202), multiple exposure (□ 216), and time-lapse photography (□ 229) can not be used while HDR is in effect and shutter speeds of **b u l b** and **- -** are not available.



First exposure (darker)

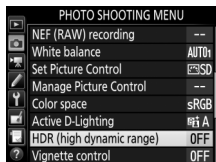


Second exposure (brighter)



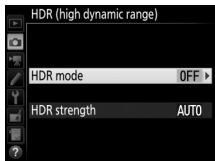
Combined HDR image


- Select HDR (high dynamic range).** Highlight **HDR (high dynamic range)** in the photo shooting menu and press **Q**.




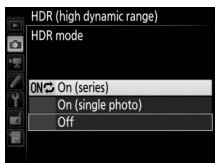
2 Select a mode.

Highlight **HDR mode** and press .



Highlight one of the following and press .

- **To take a series of HDR photographs, select **ON**  **On (series)**.** HDR shooting will continue until you select **Off** for **HDR mode**.
- **To take one HDR photograph, select **On (single photo)**.** Normal shooting will resume automatically after you have created a single HDR photograph.
- **To exit without creating additional HDR photographs, select **Off**.**





If **On (series)** or **On (single photo)** is selected, a **HDR** icon will be displayed in the viewfinder.



Viewfinder

3 Choose the HDR strength.

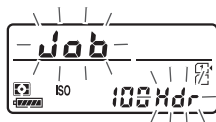
To choose the difference in exposure between the two shots (HDR strength), highlight **HDR strength** and press .

Highlight the desired option and press . If **Auto** is selected, the camera will automatically adjust HDR strength to suit the scene.



4 Frame a photograph, focus, and shoot.

The camera takes two exposures when the shutter-release button is pressed all the way down. **Job Hdr** will flash in the control panel and **HDR Job** in the viewfinder while the images are combined; no photographs can be taken until recording is complete. Regardless of the option currently selected for release mode, only one photograph will be taken each time the shutter-release button is pressed.



Control panel



Viewfinder

If **On (series)** is selected, HDR will only turn off when **Off** is selected for **HDR mode**; if **On (single photo)** is selected, HDR turns off automatically after the photograph is taken. The **HDR** icon clears from the display when HDR shooting ends.

Framing HDR Photographs

The edges of the image will be cropped out. The desired results may not be achieved if the camera or subject moves during shooting. Use of a tripod is recommended. Depending on the scene, the effect may not be visible, shadows may appear around bright objects, or halos may appear around dark objects. Uneven shading may be visible with some subjects.

Interval Timer Photography








If **On (series)** is selected for **HDR mode** before interval timer shooting begins, the camera will continue to shoot HDR photographs at the selected interval (if **On (single photo)** is selected, interval timer shooting will end after a single shot).

Flash Photography



Using the Built-in Flash

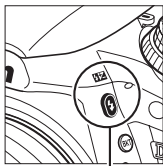
The built-in flash can be used not only when natural lighting is inadequate but to fill in shadows and backlit subjects or to add a catch light to the subject's eyes.



Auto Pop-up Modes

In , , , , , , and  modes, the built-in flash automatically pops up and fires as required.

1 Choose a flash mode.

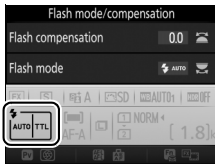
Keeping the  () button pressed, rotate the main command dial until the desired flash mode appears in the information display.



 () button



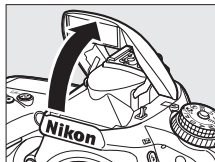
Main command dial



Information display

2 Take pictures.

The flash will pop up as required when the shutter-release button is pressed halfway and fire when a photograph is taken. *If the flash does not pop up*




automatically, DO NOT attempt to raise it by hand. Failure to observe this precaution could damage the flash.


Flash Modes

The following flash modes are available:




Auto flash: When lighting is poor or the subject is backlit, the flash pops up automatically when the shutter-release button is pressed halfway and fires as required. Not available in  mode.




Auto with red-eye reduction: Use for portraits. The flash pops up and fires as required, but before it fires the red-eye reduction lamp lights to help reduce “red-eye.” Not available in  mode.



Auto slow sync with red-eye reduction: As for auto with red-eye reduction, except that slow shutter speeds are used to capture background lighting. Use for portraits taken at night or under low light. Available in  mode.



Auto slow sync: Slow shutter speeds are used to capture background lighting in shots taken at night or under low light. Available in  mode.



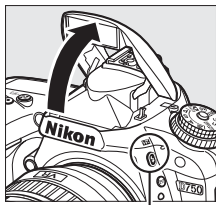
Off: The flash does not fire.

Manual Pop-up Modes

In **P**, **S**, **A**, **M**, and **Ⓜ** modes, the flash must be raised manually. The flash will not fire if it is not raised.

1 Raise the flash.

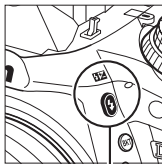
Press the **⚡ (Ⓜ)** button to raise the flash. Note that if the flash is off or an optional external flash unit is attached, the built-in flash will not pop up; proceed to Step 2.



⚡ (Ⓜ) button

2 Choose a flash mode (**P**, **S**, **A**, and **M** modes only).

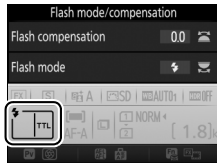
Keeping the **⚡ (Ⓜ)** button pressed, rotate the main command dial until the desired flash mode appears in the information display.



⚡ (Ⓜ) button



Main command dial



Information display

3 Take pictures.

If an option other than **Ⓜ** is selected, the flash will fire whenever a picture is taken.

Flash Modes

The following flash modes are available:



Fill flash: The flash fires with every shot.



Red-eye reduction: Use for portraits. The flash fires with every shot, but before it fires, the red-eye reduction lamp lights to help reduce “red-eye.” Not available in **ff** mode.



Red-eye reduction with slow sync: As for “red-eye reduction”, above, except that shutter speed slows automatically to capture background lighting at night or under low light. Use when you want to include background lighting in portraits. Not available in modes **S**, **M**, and **ff**.



Slow sync: As for “fill flash”, above, except that shutter speed slows automatically to capture background lighting at night or under low light. Use when you want to capture both subject and background. Not available in modes **S**, **M**, and **ff**.



Slow rear-curtain sync: As for “rear-curtain sync”, below, except that shutter speed slows automatically to capture background lighting at night or under low light. Use when you want to capture both subject and background. Not available in modes **S**, **M**, and **ff**. **SLOW** is displayed when setting is complete.

Rear-curtain sync: The flash fires just before the shutter closes, creating a stream of light behind moving light sources as shown below at right. Not available in modes **P**, **A**, and **ff**.



Front-curtain sync



Rear-curtain sync



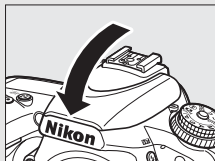
Off: The flash does not fire. Not available in **ff** mode.

Metering

Select matrix, center-weighted, or highlight-weighted metering to activate i-TTL balanced fill-flash for digital SLR. Standard i-TTL flash for digital SLR is activated automatically when spot metering is selected.


Lowering the Built-in Flash

To save power when the flash is not in use, press it gently downward until the latch clicks into place.



The Built-in Flash










Remove lens hoods to prevent shadows. The flash has a minimum range of 0.6 m (2 ft) and can not be used in the macro range of zoom lenses with a macro function. i-TTL flash control is available at ISO sensitivities between 100 and 12800; at other sensitivities, the desired results may not be achieved at some ranges or aperture values.

If the flash fires in continuous release modes ( 103), only one picture will be taken each time the shutter-release button is pressed.

The shutter release may be briefly disabled to protect the flash after it has been used for several consecutive shots. The flash can be used again after a short pause.

Shutter Speeds Available with the Built-in Flash

The following shutter speeds are available with the built-in flash.


Mode	Shutter speed
AUTO,  ,  ,  ,  ,  ,  ,  , 	1/200–1/60 s
	1/200–1 s
P*, A*	1/250–1/60 s
S*	1/250–30 s
M*	1/250–30 s, bulb, - -







* Speeds as fast as 1/4000 s are available with optional flash units that support auto FP high-speed sync (□ 436) when **1/250 s (Auto FP)** or **1/200 s (Auto FP)** is selected for Custom Setting e1 (**Flash sync speed**, □ 345). When **1/250 s (Auto FP)** is selected, shutter speeds as fast as 1/250 s are available with the built-in flash.

Flash Control Mode

The camera supports the following i-TTL flash control modes:

- **i-TTL balanced fill-flash for digital SLR:** Flash emits series of nearly invisible preflashes (monitor preflashes) immediately before main flash. Preflashes reflected from objects in all areas of frame are picked up by RGB sensor with approximately 91K (91,000) pixels and are analyzed in combination with range information from matrix metering system to adjust flash output for natural balance between main subject and ambient background lighting. If type G, E, or D lens is used, distance information is included when calculating flash output. Precision of calculation can be increased for non-CPU lenses by providing lens data (focal length and maximum aperture; see □ 235). Not available when spot metering is used.
- **Standard i-TTL flash for digital SLR:** Flash output adjusted to bring lighting in frame to standard level; brightness of background is not taken into account. Recommended for shots in which main subject is emphasized at expense of background details, or when exposure compensation is used. Standard i-TTL flash for digital SLR is activated automatically when spot metering is selected.

The flash control mode for the built-in flash can be selected using Custom Setting e3 (**Flash ctrl for built-in flash**,  347). The information display shows the flash control mode for the built-in flash as follows:

	Flash sync	Auto FP ( 345)
i-TTL		—
Manual		—
Repeating flash		—
Commander mode		

Aperture, Sensitivity, and Flash Range

Flash range varies with sensitivity (ISO equivalency) and aperture.

Aperture at ISO equivalent of								Range	
100	200	400	800	1600	3200	6400	12800	m	ft
1.4	2	2.8	4	5.6	8	11	16	0.7–8.5	2ft 4in.–27ft 10in.
2	2.8	4	5.6	8	11	16	22	0.6–6.0	2ft–19ft 8in.
2.8	4	5.6	8	11	16	22	32	0.6–4.2	2ft–13ft 9in.
4	5.6	8	11	16	22	32	—	0.6–3.0	2ft–9ft 10in.
5.6	8	11	16	22	32	—	—	0.6–2.1	2ft–6ft 10in.
8	11	16	22	32	—	—	—	0.6–1.5	2ft–4ft 11in.
11	16	22	32	—	—	—	—	0.6–1.1	2ft–3ft 7in.
16	22	32	—	—	—	—	—	0.6–0.8	2ft–2ft 7in.

The built-in flash has a minimum range of 0.6 m (2 ft).

In mode P, the maximum aperture (minimum f-number) is limited according to ISO sensitivity, as shown below:

Maximum aperture at ISO equivalent of:							
100	200	400	800	1600	3200	6400	12800
2.8	3.5	4	5	5.6	7.1	8	10

If the maximum aperture of the lens is smaller than given above, the maximum value for aperture will be the maximum aperture of the lens.

See Also

See page 190 for information on locking flash value (FV) for a metered subject before recomposing a photograph.

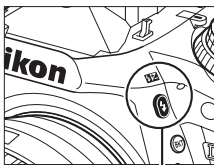
For information on auto FP high-speed sync and choosing a flash sync speed, see Custom Setting e1 (**Flash sync speed**, [□ 345](#)). For information on choosing the slowest shutter speed available when using the flash, see Custom Setting e2 (**Flash shutter speed**, [□ 346](#)). For information on flash control and using the built-in flash in commander mode, see Custom Setting e3 (**Flash cntrl for built-in flash**, [□ 347](#)).

See page 433 for information on using optional flash units.

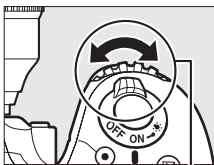
Flash Compensation (*P, S, A, M, and SCENE Modes Only*)

Flash compensation is used to alter flash output by from -3 EV to $+1\text{ EV}$ in increments of $\frac{1}{3}\text{ EV}$, changing the brightness of the main subject relative to the background. Flash output can be increased to make the main subject appear brighter, or reduced to prevent unwanted highlights or reflections.

Press the **⚡ (1/2)** button and rotate the sub-command dial until the desired value is displayed in the control panel, viewfinder, or information display. In general, choose positive values to make the main subject brighter, negative values to make it darker.



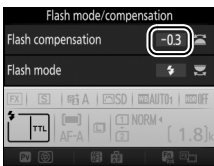
⚡ (1/2) button



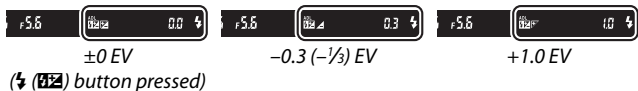
Sub-command dial






Control panel



Information display





At values other than ± 0.0 , a  icon will be displayed in the control panel and viewfinder after you release the  button. The current value for flash compensation can be confirmed by pressing the  button.

Normal flash output can be restored by setting flash compensation to ± 0.0 . Flash compensation is not reset when the camera is turned off.

Optional Flash Units

The flash compensation selected with the optional flash unit is added to the flash compensation selected with the camera.




See Also

For information on choosing the size of the increments available for flash compensation, see Custom Setting b2 (**EV steps for exposure cntrl**,  333). For information on choosing how flash and exposure compensation combine, see Custom Setting e4 (**Exposure comp. for flash**,  353). For information on automatically varying flash level over a series of shots, see page 202.

FV Lock










This feature is used to lock flash output, allowing photographs to be recomposed without changing the flash level and ensuring that flash output is appropriate to the subject even when the subject is not positioned in the center of the frame. Flash output is adjusted automatically for any changes in ISO sensitivity and aperture.

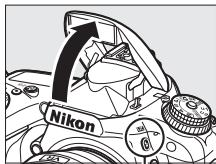
To use FV lock:


- 1 Assign FV lock to a camera control.** Select **FV lock** as the “press” option for Custom Setting f2 (**Assign Fn button**,  356), f3 (**Assign preview button**,  361), or f4 (**Assign AE-L/AF-L button**,  361).



- 2 Raise the flash.**

In **P**, **S**, **A**, **M**, and **11** modes, the flash can be raised by pressing the  button. In **AUTO**, , , , , , , , and  modes, the flash will pop up automatically when required.



 button

- 3 Focus.**

Position the subject in the center of the frame and press the shutter-release button halfway to focus.



4 Lock flash level.

After confirming that the flash ready indicator (⚡) is displayed in the viewfinder, press the button selected in Step 1. The flash will emit a monitor preflash to determine the appropriate flash level. Flash output will be locked at this level and FV lock icons (🔒) will appear in the viewfinder.



5 Recompose the photograph.




6 Take the photograph.

Press the shutter-release button the rest of the way down to shoot. If desired, additional pictures can be taken without releasing FV lock.


7 Release FV lock.

Press the button selected in Step 1 to release FV lock. Confirm that the FV lock icon (🔒) is no longer displayed in the viewfinder.

Using FV Lock with the Built-in Flash

FV lock is only available with the built-in flash when **TTL** is selected for Custom Setting e3 (**Flash cntrl for built-in flash**,  347).

Using FV Lock with Optional Flash Units

FV lock is also available with optional flash units in TTL and (where supported) monitor pre-flash AA and monitor pre-flash A flash control modes. Note that when commander mode is selected for Custom Setting e3 (**Flash cntrl for built-in flash**,  347), you will need to set the flash control mode for the master or at least one remote group to TTL or AA.

Metering

The metering areas for FV lock when using optional flash unit are as follows:


Flash unit	Flash mode	Metered area
Stand-alone flash unit	i-TTL	5-mm circle in center of frame
	AA	Area metered by flash exposure meter
Used with other flash units (Advanced Wireless Lighting)	i-TTL	Entire frame
	AA	Area metered by flash exposure meter
	A (master flash)	

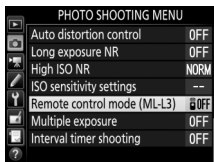
Remote Control Photography

Using an Optional ML-L3 Remote Control

The optional ML-L3 remote control (☞ 444) can be used to reduce camera shake or for self-portraits.





1 Select Remote control mode (ML-L3).

Highlight **Remote control mode (ML-L3)** in the photo shooting menu and press .



2 Choose a remote control mode.

Highlight one of the following options and press .

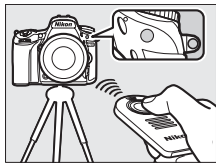
Option	Description
 2s Delayed remote	Shutter is released 2 s after ML-L3 shutter-release button is pressed.
 Quick-response remote	Shutter is released when ML-L3 shutter-release button is pressed.
 Remote mirror-up	Press ML-L3 shutter-release button once to raise mirror, again to release shutter and take photograph. Prevents blur caused by camera moving when mirror is raised.
 Off	The shutter can not be released using the ML-L3.

3 Frame the photograph.

Mount the camera on a tripod or place the camera on a stable, level surface.

4 Take the photograph.

From a distance of 5 m (16 ft) or less, aim the transmitter on the ML-L3 at either of the infrared receivers on the camera (☐ 2, 4) and press the ML-L3 shutter-release button. *In delayed remote mode*, the self-timer lamp will light for about two seconds before the shutter is released. *In quick-response remote mode*, the self-timer lamp will flash after the shutter has been released. *In remote mirror-up mode*, pressing the ML-L3 shutter-release button once raises the mirror; the shutter will be released and the self-timer lamp will flash after 30 s or when the button is pressed a second time.





Release Mode

When an optional ML-L3 remote control is used, the release mode selected with the release mode dial (☐ 103) is ignored in favor of the option selected for **Remote control mode (ML-L3)** in the shooting menu.

Before Using Optional ML-L3 Remote Controls

Before using the remote control for the first time, remove the clear plastic battery-insulator sheet.

✎ Using the Built-in Flash

Before taking a photograph with the flash in manual pop-up modes (☐ 182), press the  (🔋) button to raise the flash and wait for the  indicator to be displayed in the viewfinder (☐ 11). Shooting will be interrupted if the flash is raised while remote control mode is in effect. If the flash is required, the camera will only respond to the ML-L3 shutter-release button once the flash has charged. In auto pop-up modes (☐ 180), the flash will begin charging when remote control mode is selected; once the flash is charged, it will automatically pop up and fire when required.

In flash modes that support red-eye reduction, the red-eye reduction lamp will light for about one second before the shutter is released. In delayed remote mode, the self-timer lamp will light for two seconds, followed by the red-eye reduction lamp which lights for one second before the shutter is released.

✎ Focusing in Remote Control Mode

The camera will not adjust focus continuously when continuous-servo autofocus is selected; note however that regardless of the autofocus mode selected, you can focus by pressing the camera shutter-release button halfway before shooting. If auto- or single-servo autofocus is selected or the camera is in live view in delayed or quick-response remote mode, the camera will automatically adjust focus before shooting; if the camera is unable to focus in viewfinder photography, it will return to stand-by without releasing the shutter.


✎ Remote Mirror-up Mode

While the mirror is raised, photos can not be framed in the viewfinder and autofocus and metering will not be performed.

✎ Exiting Remote Control Mode

Remote control is cancelled automatically if no photograph is taken before the time selected for Custom Setting c5 (**Remote on duration (ML-L3)**, ☐ 337), **Off** is selected for **Remote control mode (ML-L3)**, a two-button reset is performed (☐ 199), or shooting options are reset using **Reset photo shooting menu** (☐ 311).

✔ Assign Shutter Button

If **Record movies** is selected for Custom Setting g4 (**Assign shutter button**, □ 373), the ML-L3 can not be used when the live view selector is rotated to .

✎ Cover the Viewfinder

To prevent light entering via the viewfinder from appearing in photographs or interfering with exposure, remove the rubber eyecup and cover the viewfinder with the supplied eyepiece cap (□ 107).

✎ See Also

For information on choosing the length of time the camera will remain in stand-by mode waiting for a signal from the remote control, see Custom Setting c5 (**Remote on duration (ML-L3)**; □ 337). For information on controlling the beeps that sound when the remote control is used, see Custom Setting d1 (**Beep**; □ 338).

Wireless Remote Controllers

When the camera is used with optional WR-1 (📖 444) and WR-R10/WR-T10 (📖 444) wireless remote controllers, the shutter-release buttons on the WR-1 and WR-T10 perform the same functions as the camera shutter-release button, allowing remote continuous and self-timer photography.

WR-1 Wireless Remote Controllers

The WR-1 can function as either a transmitter or a receiver and is used in combination either with another WR-1 or a WR-R10 or WR-T10 wireless remote controller. For example, a WR-1 can be connected to the accessory terminal for use as a receiver, allowing camera settings to be changed or the shutter to be released remotely by another WR-1 acting as a transmitter.

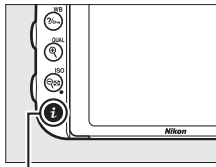
WR-R10/WR-T10 Wireless Remote Controllers

When a WR-R10 (transceiver) is connected to the camera, the shutter can be released using a WR-T10 (transmitter).

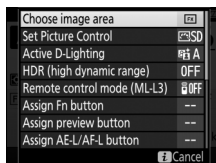
Other Shooting Options

Viewfinder Photography: The *i* Button

Pressing the *i* button during viewfinder photography displays a menu with the following options:



i button





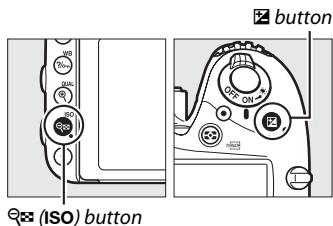
Option	
Choose image area	110
Set Picture Control	165
Active D-Lighting	175
HDR (high dynamic range)	177
Remote control mode (ML-L3)	193


Option	
Assign Fn button	356
Assign preview button	361
Assign AE-L/AF-L button	361
Long exposure NR	317
High ISO NR	317







To exit the *i*-button menu and return to the shooting display, press the *i* button again.









Two-Button Reset: Restoring Default Settings

The camera settings listed below can be restored to default values by holding the  (ISO) and  buttons down together for more than two seconds (these buttons are marked by a green dot). The control panel turns off briefly while settings are reset.



Option	Default	
Image quality	JPEG normal	115
Image size	Large	118
White balance	Auto > Normal	145
Fine tuning	A-B: 0, G-M: 0	149
Picture Control settings ¹	Unmodified	165
HDR (high dynamic range)	Off ²	177
ISO sensitivity settings		
ISO sensitivity		
P, S, A, M	100	134
Other modes	Auto	
Auto ISO sensitivity control	Off	136
Remote control mode (ML-L3)	Off	193
Interval timer shooting	Off ³	222

Option	Default	
Autofocus (viewfinder)		
Autofocus mode		
	AF-S	121
Other modes	AF-A	
AF-area mode		
	Single-point AF	123
	51-point dynamic-area AF	
 P, S, A, M	Auto-area AF	
Autofocus (live view/movie)		
Autofocus mode	AF-S	57
AF-area mode		
 P, S, A, M	Wide-area AF	58
	Normal-area AF	
	Face-priority AF	
Focus point ⁴	Center	127
Exposure preview	Off	62
Multi-selector power aperture	Disable	72
Highlight display	Off	72
Headphone volume	15	72
Metering	Matrix	139
AE lock hold	Off	129, 141
Bracketing	Off ⁵	202
Flash compensation	Off	188
Exposure compensation	Off	143
Exposure delay mode	Off	339


Option	Default	
Flash mode		
     	Auto	
	Auto+red-eye reduction	181,
	Auto+slow sync	183
¶¶, P, S, A, M	Fill flash	
FV lock	Off	190
Multiple exposure	Off ⁶	216
Flexible program	Off	89
+ NEF (RAW)	Off	357

1 Current Picture Control only.

2 HDR strength is not reset.

3 If interval timer shooting is currently in progress, shooting will end. Starting time, shooting interval, number of intervals and shots, and exposure smoothing are not reset.

4 Focus point not displayed if auto-area AF is selected for AF-area mode.

5 Number of shots is reset to zero. Bracketing increment is reset to 1 EV (exposure/flash bracketing) or 1 (white balance bracketing).  **A Auto** is selected for the second shot of two-shot ADL bracketing programs.

6 If multiple exposure is currently in progress, shooting will end and multiple exposure will be created from exposures recorded to that point. Gain and number of shots are not reset.

Bracketing

(P, S, A, and M Modes Only)

Bracketing automatically varies exposure, flash level, Active D-Lighting (ADL), or white balance slightly with each shot, “bracketing” the current value. Choose in situations in which it is difficult to set exposure, flash level (i-TTL and, where supported, auto aperture flash control modes only; see pages 185, 347, and 435), white balance, or Active D-Lighting and there is not time to check results and adjust settings with each shot, or to experiment with different settings for the same subject.

■ Exposure and Flash Bracketing

Vary exposure and/or flash level over a series of photographs.



Exposure modified by:
0 EV



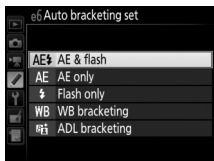
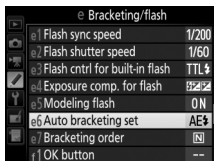
Exposure modified by:
-1 EV



Exposure modified by:
+1 EV

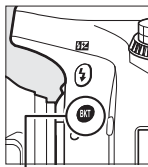
1 Select flash or exposure bracketing.

Select Custom Setting e6 (**Auto bracketing set**) in the Custom Settings menu, highlight an option, and press **OK**. Choose **AE & flash** to vary both exposure and flash level, **AE only** to vary only exposure, or **Flash only** to vary only flash level.



2 Choose the number of shots.

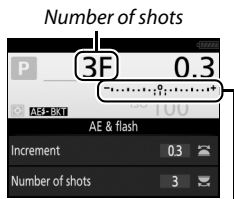
Pressing the **BKT** button, rotate the main command dial to choose the number of shots in the bracketing sequence. The number of shots is shown in the information display and control panel.



BKT button



Main command dial



Exposure and flash bracketing indicator
Information display

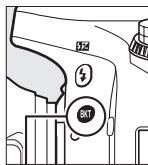
At settings other than zero, a **BKT** icon is displayed in the control panel.



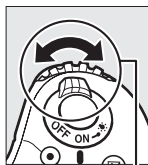
BKT appears in the viewfinder, while the information display provides a bracketing indicator and an icon showing the type of bracketing: **AE-BKT** (exposure and flash bracketing), **AE-BKT** (exposure bracketing only), or **BKT** (flash bracketing only).

3 Select an exposure increment.

Pressing the **BKT** button and rotate the sub-command dial to choose the exposure increment.

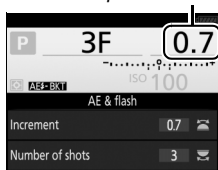


BKT button



Sub-command dial

Exposure increment



Information display

At default settings, the size of the increment can be chosen from 0.3 ($\frac{1}{3}$), 0.7 ($\frac{2}{3}$), 1, 2, and 3 EV. The bracketing programs with an increment of 0.3 ($\frac{1}{3}$) EV are listed below.

Information display	No. of shots	Bracketing order (EVs)
0F 0.3	0	0
+3F 0.3	3	0/+0.3/+0.7
-3F 0.3	3	0/-0.7/-0.3
+2F 0.3	2	0/+0.3
-2F 0.3	2	0/-0.3
3F 0.3	3	0/-0.3/+0.3
5F 0.3	5	0/-0.7/-0.3/+0.3/+0.7
7F 0.3	7	0/-1.0/-0.7/-0.3/+0.3/+0.7/+1.0
9F 0.3	9	0/-1.3/-1.0/-0.7/-0.3/+0.3/+0.7/+1.0/+1.3

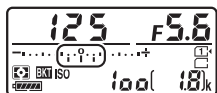
Note that for exposure increments of 2 EV or more, the maximum number of shots is 5; if a higher value was selected in Step 2, the number of shots will automatically be set to 5.

4 Frame a photograph, focus, and shoot.

The camera will vary exposure and/or flash level shot-by-shot according to the bracketing program selected. Modifications to exposure are added to those made with exposure compensation (see page 143).



A bracketing progress indicator is displayed while bracketing is in effect. A segment will disappear from the indicator after each shot.



No. shots: 3; increment: 0.7



Display after first shot

See Also

For information on choosing the size of the increment, see Custom Setting b2 (**EV steps for exposure cntrl**, 333). For information on choosing the order in which bracketing is performed, see Custom Setting e7 (**Bracketing order**, 354).

■ ■ *Canceling Bracketing*

To cancel bracketing, press the **BKT** button and rotate the main command dial until the number of shots in the bracketing sequence is zero (**0F/0F**) and the exposure/flash bracketing indicators are no longer displayed. The program last in effect will be restored the next time bracketing is activated. Bracketing can also be cancelled by performing a two-button reset (☐ 199), although in this case the bracketing program will not be restored the next time bracketing is activated.

Exposure and Flash Bracketing

In continuous release modes (☐ 103), shooting will pause after the number of shots specified in the bracketing program have been taken. Shooting will resume the next time the shutter-release button is pressed. In self-timer mode, the camera will take the number of shots selected in Step 2 on page 203 each time the shutter-release button is pressed, regardless of the option selected for Custom Setting c3 (**Self-timer**) > **Number of shots** (☐ 337); the interval between shots is however controlled by Custom Setting c3 (**Self-timer**) > **Interval between shots**. In other modes, one shot will be taken each time the shutter-release button is pressed.

If the memory card fills before all shots in the sequence have been taken, shooting can be resumed from the next shot in the sequence after the memory card has been replaced or shots have been deleted to make room on the memory card. If the camera is turned off before all shots in the sequence have been taken, bracketing will resume from the next shot in the sequence when the camera is turned on.

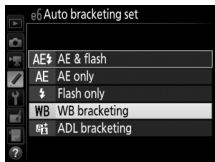
Exposure Bracketing

The camera modifies exposure by varying shutter speed and aperture (mode **P**), aperture (mode **S**), or shutter speed (modes **A** and **M**). If **On** is selected for **ISO sensitivity settings > Auto ISO sensitivity control** (📖 136) in modes **P**, **S**, and **A**, the camera will automatically vary ISO sensitivity for optimum exposure when the limits of the camera exposure system are exceeded; in mode **M**, the camera will first use auto ISO sensitivity control to bring exposure as close as possible to the optimum and then bracket this exposure by varying shutter speed.

■ White Balance Bracketing

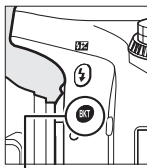
The camera creates multiple copies of each photograph, each with a different white balance. For more information on white balance, see page 145.

- 1 Select white balance bracketing.**
Choose **WB bracketing** for Custom Setting e6 **Auto bracketing set**.

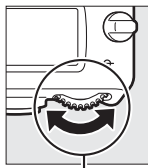


- 2 Choose the number of shots.**

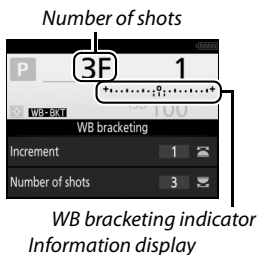
Pressing the **BKT** button, rotate the main command dial to choose the number of shots in the bracketing sequence. The number of shots is shown in the information display and control panel.



BKT button



Main command dial



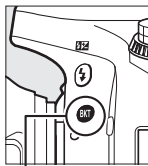
WB bracketing indicator
Information display

At settings other than zero, **BKT** and **BKT** are displayed respectively in the control panel and viewfinder; a **WB-BKT** icon and a bracketing indicator appear in the information display.



3 Select a white balance increment.

Pressing the **BKT** button, rotate the sub-command dial to choose from increments of 1 (5 mired; □ 151), 2 (10 mired), or 3 (15 mired). The **B** value indicates the amount of blue, the **A** value the amount of amber (□ 149).



BKT button



Sub-command dial

White balance increment



Information display

The bracketing programs with an increment of 1 are listed below.

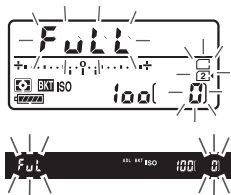
Information display	No. of shots	White balance increment	Bracketing order
B2F 1 +.....;:.....+	2	1B	0/1B
A2F 1 +.....;:.....+	2	1A	0/1A
3F 1 +.....;:.....+	3	1A, 1B	0/1A/1B

4 Frame a photograph, focus, and shoot.

Each shot will be processed to create the number of copies specified in the bracketing program, and each copy will have a different white balance. Modifications to white balance are added to the white balance adjustment made with white balance fine-tuning.



If the number of shots in the bracketing program is greater than the number of exposures remaining, **FULL** and the icon for the affected card will flash in the control panel, a flashing **FuL** icon will appear in the viewfinder as shown at right, and the shutter release will be disabled.



Shooting can begin when a new memory card is inserted.

■ ■ **Canceling Bracketing**

To cancel bracketing, press the **BKT** button and rotate the main command dial until the number of shots in the bracketing sequence is zero (**0F/0F**) and the white balance bracketing indicators are no longer displayed. The program last in effect will be restored the next time bracketing is activated. Bracketing can also be cancelled by performing a two-button reset (☐ 199), although in this case the bracketing program will not be restored the next time bracketing is activated.

🔪 **White Balance Bracketing**

White balance bracketing is not available at an image quality of NEF (RAW). Selecting **NEF (RAW)**, **NEF (RAW)+JPEG fine**, **NEF (RAW)+JPEG normal**, or **NEF (RAW)+JPEG basic** cancels white balance bracketing.

White balance bracketing affects only color temperature (the amber-blue axis in the white balance fine-tuning display, ☐ 149). No adjustments are made on the green-magenta axis.

In self-timer mode (☐ 106), the number of copies specified in the white-balance program will be created each time the shutter is released, regardless of the option selected for Custom Setting c3 (**Self-timer**) > **Number of shots** (☐ 337).

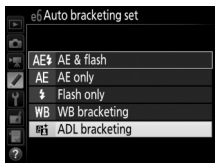
If the camera is turned off while the memory card access lamp is lit, the camera will power off only after all photographs in the sequence have been recorded.

■ ■ ADL Bracketing

The camera varies Active D-Lighting over a series of exposures. For more information on Active D-Lighting, see page 175.

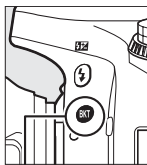
1 Select ADL bracketing.

Choose **ADL bracketing** for Custom Setting e6 **Auto bracketing set**.



2 Choose the number of shots.

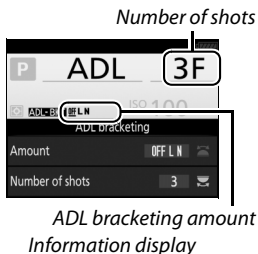
Pressing the **BKT** button, rotate the main command dial to choose the number of shots in the bracketing sequence. The number of shots is shown in the information display and control panel.



BKT button



Main command dial



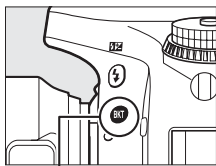
ADL bracketing amount
Information display

At settings other than zero, **BKT** and **BKT** are displayed respectively in the control panel and viewfinder; a **ADL-BKT** icon and the bracketing amount appear in the information display.

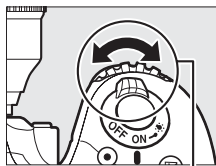
Choose two shots to take one photograph with Active D-Lighting off and another at a selected value. Choose three to five shots to take a series of photographs with Active D-Lighting set to **Off**, **Low**, and **Normal** (three shots), **Off**, **Low**, **Normal**, and **High** (four shots), or **Off**, **Low**, **Normal**, **High**, and **Extra high** (five shots). If you choose more than two shots, proceed to Step 4.

3 Select Active D-Lighting.

Pressing the **BKT** button, rotate the sub-command dial to choose Active D-Lighting.



BKT button



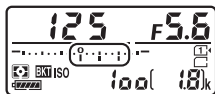
Sub-command dial

Active D-Lighting is shown in the information display and control panel.

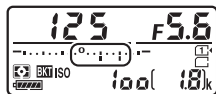
Active D-Lighting	Information display	Control panel display
A Auto	<u>OFF</u> AUTO	Auto
L Low	<u>OFF</u> L	L
N Normal	<u>OFF</u> N	n
H High	<u>OFF</u> H	H
H⁺ Extra high	<u>OFF</u> H ⁺	HP

4 Frame a photograph, focus, and shoot.

The camera will vary Active D-Lighting shot-by-shot according to the bracketing program selected. A bracketing progress indicator is displayed while bracketing is in effect. A segment will disappear from the indicator after each shot.



No. shots: 3



Display after first shot

■ ■ *Canceling Bracketing*

To cancel bracketing, press the **BKT** button and rotate the main command dial until the number of shots in the bracketing sequence is zero (**0F/0F**) and the ADL bracketing indicators are no longer displayed. The program last in effect will be restored the next time bracketing is activated. Bracketing can also be cancelled by performing a two-button reset (☐ 199), although in this case the bracketing program will not be restored the next time bracketing is activated.

🔪 **ADL Bracketing**

In continuous release modes (☐ 103), shooting will pause after the number of shots specified in the bracketing program have been taken. Shooting will resume the next time the shutter-release button is pressed. In self-timer mode, the camera will take the number of shots selected in Step 2 on page 212 each time the shutter-release button is pressed, regardless of the option selected for Custom Setting c3 (**Self-timer**) > **Number of shots** (☐ 337); the interval between shots is however controlled by Custom Setting c3 (**Self-timer**) > **Interval between shots**. In other modes, one shot will be taken each time the shutter-release button is pressed.

If the memory card fills before all shots in the sequence have been taken, shooting can be resumed from the next shot in the sequence after the memory card has been replaced or shots have been deleted to make room on the memory card. If the camera is turned off before all shots in the sequence have been taken, bracketing will resume from the next shot in the sequence when the camera is turned on.

Multiple Exposure

(P, S, A, and M Modes Only)


Follow the steps below to record a series of two or three exposures in a single photograph. Multiple exposures can make use of RAW data from the camera image sensor to produce colors noticeably superior to those in software-generated photographic overlays.

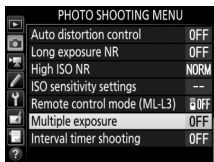
■ Creating a Multiple Exposure

Multiple exposures can not be recorded in live view. Exit live view before proceeding. Note that at default settings, shooting will end and a multiple exposure will be recorded automatically if no operations are performed for 30 s.

🔧 Extended Recording Times

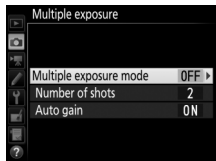
For an interval between exposures of more than 30 s, extend the meter-off delay using Custom Setting c2 (**Standby timer**, 📄 336). The maximum interval between exposures is 30 s longer than the option selected for Custom Setting c2. If the monitor turns off during playback or menu operations and no operations are performed for 30 s after the standby timer has expired, shooting will end and a multiple exposure will be created from the exposures that have been recorded to that point.


- 1 **Select Multiple exposure.**
Highlight **Multiple exposure** in the photo shooting menu and press .




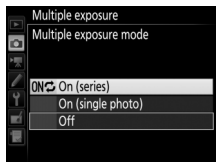
2 Select a mode.


Highlight **Multiple exposure mode** and press .




Highlight one of the following and press .

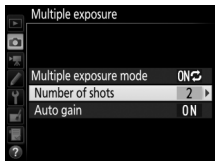
- **To take a series of multiple exposures,** select **ON  On (series)**. Multiple exposure shooting will continue until you select **Off** for **Multiple exposure mode**.
- **To take one multiple exposure,** select **On (single photo)**. Normal shooting will resume automatically after you have created a single multiple exposure.
- **To exit without creating additional multiple exposures,** select **Off**.






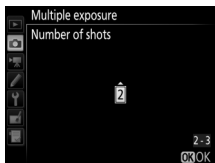
If **On (series)** or **On (single photo)** is selected, a  icon will be displayed in the control panel.



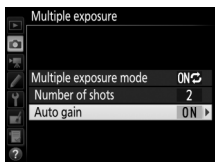
- 3 Choose the number of shots.**
Highlight **Number of shots** and press .




Press  or  to choose the number of exposures that will be combined to form a single photograph and press .

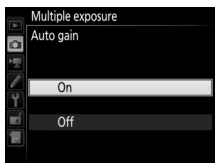


- 4 Choose the amount of gain.**
Highlight **Auto gain** and press .



The following options will be displayed. Highlight an option and press .


- **On:** Gain is adjusted according to number of exposures actually recorded (gain for each exposure is set to $\frac{1}{2}$ for 2 exposures, $\frac{1}{3}$ for 3 exposures, etc.).
- **Off:** Gain is not adjusted when recording multiple exposure. Note that photographs may be affected by noise (randomly-spaced bright pixels, fog, or lines).




5 Frame a photograph, focus, and shoot.

In continuous release modes (☞ 103), the camera records all exposures in a single burst. If **On (series)** is selected, the camera will continue to record multiple exposures while the shutter-release button is pressed; if **On (single photo)** is selected, multiple exposure shooting will end after the first photograph. In self-timer mode, the camera will automatically record the number of exposures selected in Step 3 on page 218, regardless of the option selected for Custom Setting c3 (**Self-timer**) > **Number of shots** (☞ 337); the interval between shots is however controlled by Custom Setting c3 (**Self-timer**) > **Interval between shots**. In other release modes, one photograph will be taken each time the shutter-release button is pressed; continue shooting until all exposures have been recorded (for information on interrupting a multiple exposure before all photographs are recorded, see page 220).



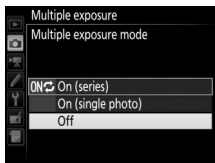
The  icon will flash until shooting ends. If **On (series)** is selected, multiple exposure shooting will only end when **Off** is selected for multiple exposure mode; if **On (single photo)**

is selected, multiple exposure shooting ends automatically when the multiple exposure is complete. The  icon clears from the display when multiple exposure shooting ends.



■ Interrupting Multiple Exposures

To interrupt a multiple exposure before the specified number of exposures have been taken, select **Off** for multiple exposure mode. If shooting ends before the specified number of exposures have been taken, a multiple exposure will be created from the exposures that have



been recorded to that point. If **Auto gain** is on, gain will be adjusted to reflect the number of exposures actually recorded.

Note that shooting will end automatically if:

- A two-button reset is performed (📖 199)
- The camera is turned off
- The battery is exhausted
- Pictures are deleted

✔ Multiple Exposures

Do not remove or replace the memory card while recording a multiple exposure.

Multiple exposures can not be recorded in live view. Taking photographs in live view resets **Multiple exposure mode** to **Off**.

The shooting information listed in the playback photo information display (including metering, exposure, shooting mode, focal length, date of recording and camera orientation) is for the first shot in the multiple exposure.

✍ Interval Timer Photography

If interval timer photography is activated before the first exposure is taken, the camera will record exposures at the selected interval until the number of exposures specified in the multiple exposure menu have been taken (the number of shots listed in the interval timer shooting menu is ignored). These exposures will then be recorded as a single photograph and interval timer shooting will end (if **On (single photo)** is selected for multiple exposure mode, multiple exposure shooting will also end automatically).

✍ Other Settings

While a multiple exposure is being shot, memory cards can not be formatted and some menu items are grayed out and can not be changed.

Interval Timer Photography

The camera is equipped to take photographs automatically at preset intervals.

✔ Before Shooting

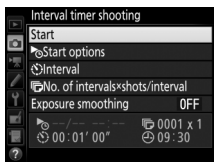
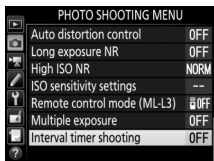
Select a release mode other than self-timer (☺) and **MuP** when using the interval timer. Before beginning interval timer photography, take a test shot at current settings and view the results in the monitor. Once settings have been adjusted to your satisfaction, remove the rubber eyecup and cover the viewfinder with the supplied eyepiece cap to prevent light entering via the viewfinder interfering with photographs and exposure (☐ 107).

Before choosing a starting time, select **Time zone and date** in the setup menu and make sure that the camera clock is set to the correct time and date (☐ 381).

Use of a tripod is recommended. Mount the camera on a tripod before shooting begins. To ensure that shooting is not interrupted, be sure the camera battery is fully charged. If in doubt, charge the battery before use or use an AC adapter and power connector (available separately).

1 Select Interval timer shooting.

Highlight **Interval timer shooting** in the photo shooting menu and press **▶** to display interval timer settings.



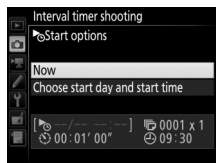
2 Adjust interval timer settings.

Choose a start option, interval, number of shots per interval, and exposure smoothing option.

- To choose a start option:



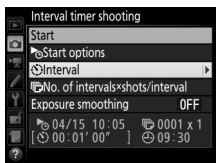
Highlight **Start options** and press \odot .



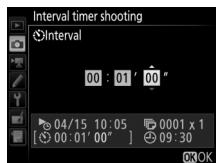
Highlight an option and press \odot .

To start shooting immediately, select **Now**. To start shooting at a chosen date and time, select **Choose start day and start time**, then choose the date and time and press \odot .

- To choose the interval between shots:

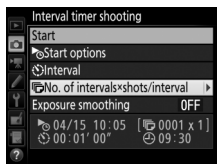


Highlight **Interval** and press \odot .

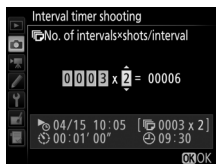


Choose an interval (hours, minutes, and seconds) and press \odot .

- To choose the number of shots per interval:



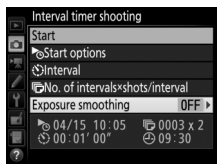
Highlight **No. of intervals × shots/interval** and press **↵**.



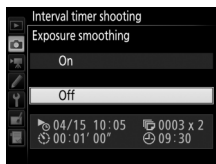
Choose the number of intervals and the number of shots per interval and press **OK**.

In **S** (single frame) mode, the photographs for each interval will be taken at the rate chosen for Custom Setting d2 (**Continuous low-speed**, [book 338](#)).

- To enable or disable exposure smoothing:



Highlight **Exposure smoothing** and press **↵**.

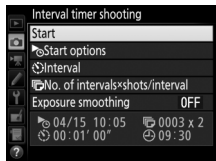


Highlight an option and press **OK**.

Selecting **On** allows the camera to adjust exposure to match previous shot in modes other than **M** (note that exposure smoothing only takes effect in mode **M** if auto ISO sensitivity control is on).

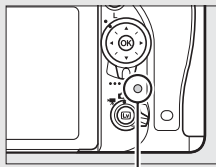
3 Start shooting.

Highlight **Start** and press **OK**. The first series of shots will be taken at the specified starting time, or after about 3 s if **Now** was selected for **Start options** in Step 2. Shooting will continue at the selected interval until all shots have been taken.



During Shooting

During interval timer photography, the memory card access lamp will flash. Immediately before the next shooting interval begins, the shutter speed display will show the number of intervals remaining, and the aperture display will show the number of shots remaining in the current interval. At other times, the number of intervals remaining and the number of shots in each interval can be viewed by pressing the shutter-release button halfway (once the button is released, the shutter speed and aperture will be displayed until the standby timer expires).



Memory card access lamp

Pictures can be played back while interval timer photography is in progress. The monitor will turn off automatically about four seconds before each interval. Note that changing camera settings while the interval timer is active may cause shooting to end.

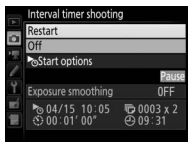
■ Pausing Interval Timer Photography

Interval timer photography can be paused between intervals by pressing **OK** or selecting **Pause** in the interval timer menu.

■ Resuming Interval Timer Shooting

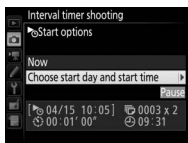
To resume shooting:

Starting Now

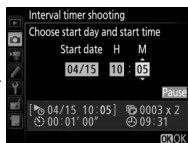


Highlight **Restart** and press **OK**.

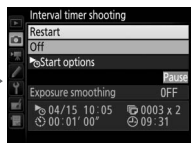
Starting at a Specified Time



For **Start options**, highlight **Choose start day and start time** and press **OK**.



Choose a starting date and time and press **OK**.



Highlight **Restart** and press **OK**.

■ Ending Interval Timer Shooting

To end interval timer photography and resume normal shooting before all the photos are taken, select **Off** in the interval timer menu.

■ ■ **No Photograph**

The camera will skip the current interval if any of the following situations persist for eight seconds or more after the interval was due to start: the photograph or photographs for the previous interval have yet to be taken, the memory card is full, or the camera is unable to focus in **AF-S** or when single-servo AF is selected in **AF-A** (note that the camera focuses again before each shot). Shooting will resume with the next interval.

☑ **Out of Memory**

If the memory card is full, the interval timer will remain active but no pictures will be taken. Resume shooting (☐ 226) after deleting some pictures or turning the camera off and inserting another memory card.

☑ **Interval Timer Photography**

Choose an interval longer than the time needed to take the selected number of shots. If the interval is too short, the number of photos taken may be less than the total listed in Step 2 (the number of intervals multiplied by the number of shots per interval). Interval timer photography can not be combined with long time-exposures (bulb or time photography, ☐ 95) or live view or time-lapse photography (☐ 54, 229) and is not available in movie live view (☐ 66) or when **Record movies** is selected for Custom Setting g4 (**Assign shutter button**, ☐ 373). Note that because the shutter speed, frame rate, and time needed to record images may vary from one interval to the next, the time between the end of one interval and the beginning of the next may vary. If shooting can not proceed at current settings (for example, if a shutter speed of $\frac{1}{200}$ or - - is currently selected in manual exposure mode, the interval is zero, or the start time is in less than a minute), a warning will be displayed in the monitor.

Interval timer shooting will pause when \odot (self-timer) or **MuP** mode is selected or if the camera is turned off and then on again (when the camera is off, batteries and memory cards can be replaced without ending interval timer photography). Pausing shooting does not affect interval timer settings.

Release Mode


Regardless of the release mode selected, the camera will take the specified number of shots at each interval.

Bracketing



Adjust bracketing settings before starting interval timer photography. If exposure, flash, or ADL bracketing is active while interval timer photography is in effect, the camera will take the number of shots in the bracketing program at each interval, regardless of the number of shots specified in the interval timer menu. If white balance bracketing is active while interval timer photography is in effect, the camera will take one shot at each interval and process it to create the number of copies specified in the bracketing program.

Time-Lapse Photography


(, , P, S, A, M, and SCENE Modes Only)

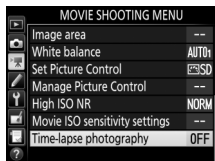
The camera automatically takes photos at selected intervals to create a silent time-lapse movie at the frame size and rate currently selected in the movie shooting menu ( 318). For information on the image area used for time-lapse movies, see page 76.

Before Shooting

Before beginning time-lapse photography, take a test shot at current settings (framing the photo in the viewfinder for an accurate exposure preview) and view the results in the monitor. For consistent coloration, choose a white balance setting other than auto ( 145). Once settings have been adjusted to your satisfaction, remove the rubber eyecup and cover the viewfinder with the supplied eyepiece cap to prevent light entering via the viewfinder interfering with photographs and exposure ( 107).

Use of a tripod is recommended. Mount the camera on a tripod before shooting begins. To ensure that shooting is not interrupted, use an optional AC adapter and power connector or a fully-charged battery.

- 1 Select Time-lapse photography.** Highlight **Time-lapse photography** in the movie shooting menu and press  to display time-lapse photography settings.



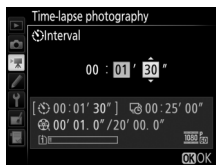
2 Adjust time-lapse photography settings.

Choose an interval, total shooting time, and exposure smoothing option.

- To choose the interval between frames:

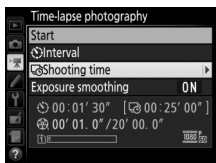


Highlight **Interval** and press .



Choose an interval longer than the slowest anticipated shutter speed (minutes and seconds) and press .

- To choose the total shooting time:

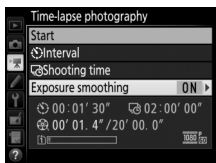


Highlight **Shooting time** and press .

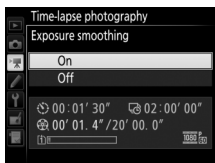


Choose shooting time (up to 7 hours 59 minutes) and press .

- To enable or disable exposure smoothing:



Highlight **Exposure smoothing** and press \odot .



Highlight an option and press \odot .

Selecting **On** smooths abrupt changes in exposure in modes other than **M** (note that exposure smoothing only takes effect in mode **M** if auto ISO sensitivity control is on).

3 Start shooting.

Highlight **Start** and press \odot . Time-lapse photography starts after about 3 s. The camera takes photographs at the selected interval for the selected shooting time. When complete, time-lapse movies are recorded to the memory card selected for **Destination** in movie shooting menu (📖 319).



■ ■ *Ending Time-Lapse Photography*

To end time-lapse photography before all the photos are taken, highlight **Off** in the time-lapse photography menu and press **OK**, or press **OK** between frames or immediately after a frame is recorded. A movie will be created from the frames shot to the point where time-lapse photography ended. Note that time-lapse photography will end and no movie will be recorded if the power source is removed or disconnected or the destination memory card is ejected.

■ ■ *No Photograph*

The camera will skip the current frame if it is unable to focus using single-servo autofocus (**AF-S** or single-servo autofocus selected for **AF-A**; note that the camera focuses again before each shot). Shooting will resume with the next frame.

Time-Lapse Photography

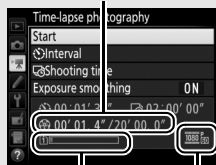
Time-lapse is not available in live view (□ 54, 66), at a shutter speed of **b** **u** **l** **b** or **- -** (□ 95), when bracketing (□ 202), High Dynamic Range (HDR, □ 177), multiple exposure (□ 216), or interval timer photography (□ 222) is active. Note that because shutter speed and the time needed to record the image to the memory card may vary from shot to shot, the interval between a shot being recorded and the start of the next shot may vary. Shooting will not begin if a time-lapse movie can not be recorded at current settings (for example, if the memory card is full, the interval or shooting time is zero, or the interval is longer than the shooting time).

Time-lapse photography may end if camera controls are used or settings are changed or HDMI cable is connected. A movie will be created from the frames shot to the point where time-lapse photography ended.

Calculating the Length of the Final Movie

The total number of frames in the final movie can be approximated by dividing the shooting time by the interval and rounding up. The length of the final movie can then be calculated by dividing the number of shots by the frame rate selected for **Frame size/frame rate** in movie shooting menu (319). A 48 frame movie recorded at **1920 x 1080; 24p**, for example, will be about two seconds long. The maximum length for movies recorded using time-lapse photography is 20 minutes.

*Length recorded/
maximum length*



*Memory card
indicator*

*Frame size/
frame rate*

During Shooting


During time-lapse photography, the memory card access lamp will flash and the time-lapse recording indicator will be displayed in the control panel. The time remaining (in hours and minutes) appears in the shutter-speed display immediately before each frame is recorded. At other times, the time remaining can be viewed by pressing the shutter-release button halfway. Regardless of the option selected for Custom Setting c2 (**Standby timer**, 336), the standby timer will not expire during shooting.





To view current time-lapse photography settings or end time-lapse photography, press the MENU button between shots.



Image Review

The  button can not be used to view pictures while time-lapse photography is in progress, but the current frame will be displayed for a few seconds after each shot if **On** is selected for **Image review** in the playback menu (📖 307). Other playback operations can not be performed while the frame is displayed.

Flash Photography

To use the flash during time-lapse photography, select mode **P**, **S**, **A**, or **M** and press the  () button to raise the flash before shooting begins.

Release Mode

Regardless of the release mode selected, the camera will take one shot at each interval. The self-timer can not be used.

See Also

For information on setting a beep to sound when time-lapse photography is complete, see Custom Setting d1 (**Beep**, 📖 338).

Non-CPU Lenses

Non-CPU lenses can be used in modes **A** and **M**, with aperture set using the lens aperture ring. By specifying lens data (lens focal length and maximum aperture), the user can gain access to the following CPU lens functions.

If the focal length of the lens is known:

- Power zoom can be used with optional flash units (📖 433)
- Lens focal length is listed (with an asterisk) in the playback photo info display

If the maximum aperture of the lens is known:

- The aperture value is displayed in the control panel and viewfinder
- Flash level is adjusted for changes in aperture if the flash unit supports AA (auto aperture) mode
- Aperture is listed (with an asterisk) in the playback photo info display

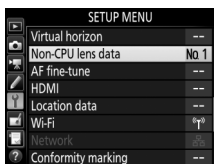
Specifying both the focal length and maximum aperture of the lens:

- Enables color matrix metering (note that it may be necessary to use center-weighted or spot metering to achieve accurate results with some lenses, including Reflex-NIKKOR lenses)
- Improves the precision of center-weighted and spot metering and i-TTL balanced fill-flash for digital SLR

The camera can store data for up to nine non-CPU lenses. To enter or edit data for a non-CPU lens:

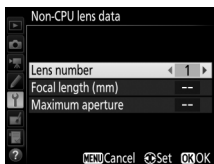
1 Select Non-CPU lens data.

Highlight **Non-CPU lens data** in the setup menu and press **▶**.



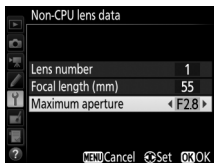
2 Choose a lens number.

Highlight **Lens number** and press **◀▶** or **▶** to choose a lens number.



3 Enter the focal length and aperture.

Highlight **Focal length (mm)** or **Maximum aperture** and press **◀▶** or **▶** to edit the highlighted item.



4 Save settings and exit.

Press **OK**. The specified focal length and aperture will be stored under the chosen lens number.

Focal Length Not Listed

If the correct focal length is not listed, choose the closest value greater than the actual focal length of the lens.

Teleconverters and Zoom Lenses

The maximum aperture for teleconverters is the combined maximum aperture of the teleconverter and the lens. Note that lens data are not adjusted when non-CPU lenses are zoomed in or out. The data for different focal lengths can be entered as separate lens numbers, or the data for the lens can be edited to reflect the new values for lens focal length and maximum aperture each time zoom is adjusted.

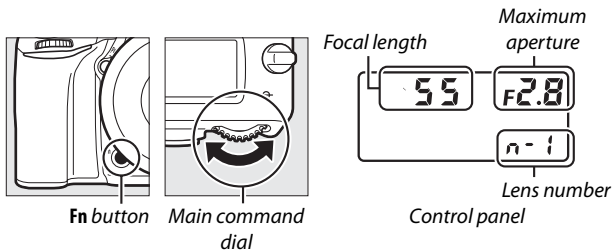
To recall lens data when using a non-CPU lens:

1 Assign non-CPU lens number selection to a camera control.

Select **Choose non-CPU lens number** as the “Press + command dials” option for a camera control in the Custom Settings menu (☞ 323). Non-CPU lens number selection can be assigned to the **Fn** button (Custom Setting f2, **Assign Fn button**, ☞ 356), the **Pv** button (Custom Setting f3, **Assign preview button**, ☞ 361), or the **AE-L/AF-L** button (Custom Setting f4, **Assign AE-L/AF-L button**, ☞ 361).

2 Use the selected control to choose the lens number.

Press the selected button and rotate the main command dial until the desired lens number is displayed in the control panel.



Location Data

The GP-1/GP-1A GPS unit (available separately) can be connected to the camera's accessory terminal (☐ 443) using the cable supplied with the GP-1/GP-1A, allowing information on the camera's current position to be recorded when photographs are taken. Turn the camera off before connecting the GP-1/GP-1A; for more information, see the GP-1/GP-1A manual.

■ ■ Setup Menu Options

The **Location data** item in the setup menu contains the options listed below.

- **Standby timer:** Choose whether the exposure meters turn off automatically when the GP-1/GP-1A is attached.


Option	Description
Enable	Exposure meters turn off automatically if no operations are performed for the period specified in Custom Setting c2 (Standby timer , ☐ 336; to allow the camera time to acquire location data, the delay is extended by up to one minute after the exposure meters are activated or the camera is turned on). This reduces the drain on the battery.
Disable	Exposure meters do not turn off while the GP-1/GP-1A is connected.




- **Position:** This item is only available if the GP-1/GP-1A is connected, when it displays the current latitude, longitude, altitude, and Coordinated Universal Time (UTC) as reported by the GP-1/GP-1A.
- **Set clock from satellite:** Select **Yes** to synchronize the camera clock with the time reported by the GPS device.

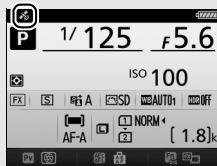
Coordinated Universal Time (UTC)

UTC data is provided by the GPS device and is independent of the camera clock.

The Icon

Connection status is shown by the  icon:


-  (**static**): The camera has established communication with GP-1/GP-1A. Photo information for pictures taken while this icon is displayed includes an additional page of location data (📖 253).
-  (**flashing**): The GP-1/GP-1A is searching for a signal. Pictures taken while the icon is flashing do not include location data.
- **No icon**: No new location data have been received from the GP-1/GP-1A for at least two seconds. Pictures taken when the  icon is not displayed do not include location data.

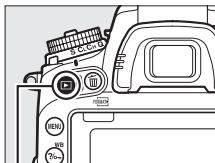


More on Playback

Viewing Pictures













Full-Frame Playback

To play photographs back, press the  button. The most recent photograph will be displayed in the monitor.



 button



To	Use	Description
View additional photographs		Press  to view photographs in order recorded,  to view photographs in reverse order.
View photo information		Press  or  to view information about current photograph (□ 246).
Return to shooting mode	 / 	Press the shutter-release button halfway or press the  button to exit to shooting mode.
Play movie		If current picture is marked with  icon to show that it is a movie, pressing  starts movie playback (□ 79).

Rotate Tall


To display “tall” (portrait-orientation) photographs in tall orientation, select **On** for the **Rotate tall** option in the playback menu (☰ 308).

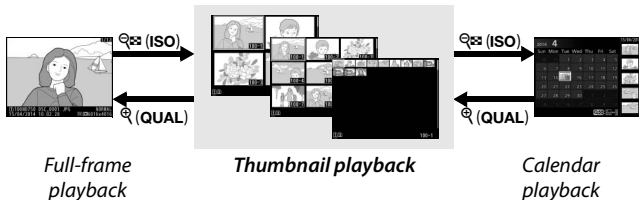











Image Review

When **On** is selected for **Image review** in the playback menu (☰ 307), photographs are automatically displayed in the monitor after shooting (because the camera is already in the correct orientation, images are not rotated automatically during image review). In continuous release modes, display begins when shooting ends, with the first photograph in the current series displayed.


Thumbnail Playback

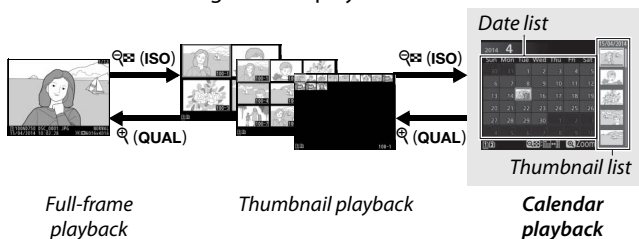
To display images in “contact sheets” of four, nine, or 72 images, press the  (ISO) button.















To	Use	Description
Highlight images		Use multi selector to highlight images for full-frame playback, playback zoom ( 255), deletion ( 258), or protection ( 257).
View highlighted image		Press  to display the highlighted image full frame.
Return to shooting mode	 / 	Press the shutter-release button halfway or press the  button to exit to shooting mode.

Calendar Playback

To view images taken on a selected date, press the  (ISO) button when 72 images are displayed.








The operations that can be performed depend on whether the cursor is in the date list or the thumbnail list:

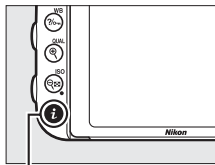
To	Use	Description
Toggle between date list and thumbnail list	 (ISO) / 	Press  (ISO) or  button in date list to place cursor in thumbnail list. Press  (ISO) again to return to date list.
Exit to thumbnail playback/Zoom in on highlighted photo	 (QUAL)	<ul style="list-style-type: none"> • Date list: Exit to 72-frame playback. • Thumbnail list: Press and hold  (QUAL) button to zoom in on highlighted picture.
Highlight dates/Highlight images		<ul style="list-style-type: none"> • Date list: Highlight date. • Thumbnail list: Highlight picture.
Toggle full frame playback		Thumbnail list: View highlighted picture.
Return to shooting mode	 / 	Press the shutter-release button halfway or press the  button to exit to shooting mode.

The *i* Button

Pressing the *i* button during full-frame or thumbnail playback displays the options listed below.

- **Playback slot and folder:** Choose a folder for playback. Highlight a slot and press  to list the folders on the selected card, then highlight a folder and press  to view the pictures in the highlighted folder.
- **Retouch (photographs only):** Use the options in the retouch menu ( 393) to create a retouched copy of the current photograph.
- **Edit movie (movies only):** Edit movies using the options in the edit movie menu ( 81). Movies can also be edited by pressing the *i* button when movie playback is paused.
- **Select to send to smart device/deselect:** Select photos for upload to a smart device ( 289).

To exit the *i*-button menu and return to playback, press the *i* button again.

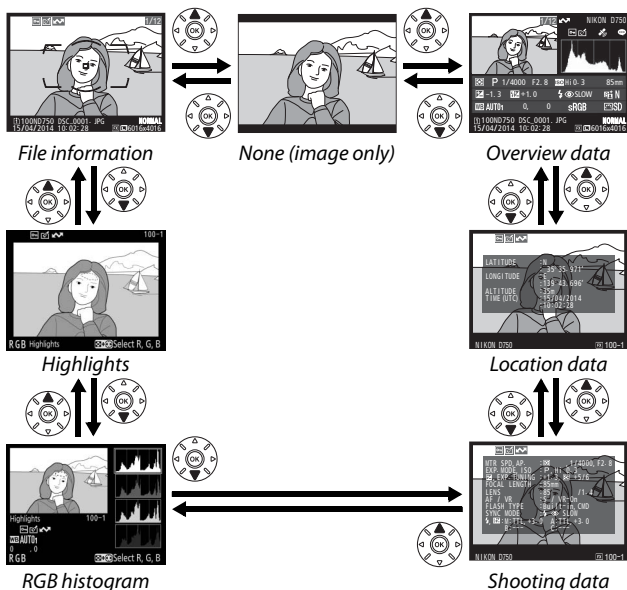


i button

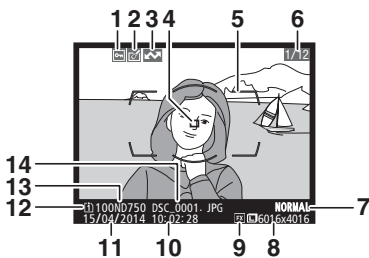


Photo Information

Photo information is superimposed on images displayed in full-frame playback. Press or to cycle through photo information as shown below. Note that “image only”, shooting data, RGB histograms, highlights, and overview data are only displayed if corresponding option is selected for **Playback display options** (📖 302). Location data are only displayed if a GP-1/GP-1A was used when the photo was taken (📖 239).



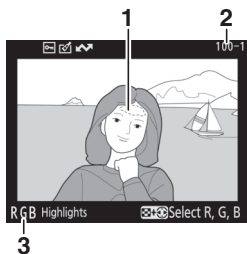
File Information



1	Protect status	257	8	Image size.....	118
2	Retouch indicator	393	9	Image area	110
3	Upload marking	290	10	Time of recording	28, 381
4	Focus point ^{1,2}	127	11	Date of recording.....	28, 381
5	AF area brackets ¹	35	12	Current card slot	119
6	Frame number/total number of frames		13	Folder name.....	311
7	Image quality.....	115	14	File name	313

- 1 Displayed only if **Focus point** is selected for **Playback display options** (☞ 302).
- 2 If photograph was taken using **AF-S** or with single-servo autofocus selected during **AF-A**, display shows point where focus first locked. If photograph was taken using **AF-C** or with continuous-servo autofocus selected during **AF-A**, focus point is only displayed if option other than auto-area AF was selected for AF-area mode and camera was able to focus.




Highlights

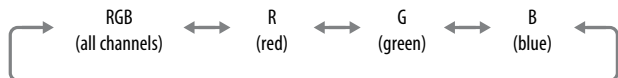
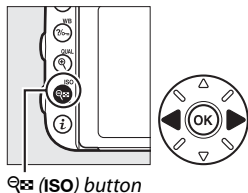


1 Image highlights*

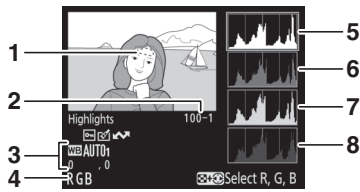
3 Current channel*

2 Folder number—frame number 311

*Flashing areas indicate highlights (areas that may be overexposed) for the current channel. Hold  (ISO) button and press  or  to cycle through channels as follows:



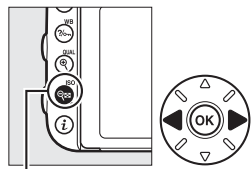
RGB Histogram



- 1 Image highlights *
- 2 Folder number—frame number 311
- 3 White balance 145
 - Color temperature 152
 - White balance fine-tuning 149
 - Preset manual 155
- 4 Current channel *

- 5 Histogram (RGB channel). In all histograms, horizontal axis gives pixel brightness, vertical axis number of pixels.
- 6 Histogram (red channel)
- 7 Histogram (green channel)
- 8 Histogram (blue channel)

* Flashing areas indicate highlights (areas that may be overexposed) for the current channel. Hold **ISO** button and press **←** or **→** to cycle through channels as follows:



ISO button



Playback Zoom

To zoom in on the photograph when the histogram is displayed, press **Q (QUAL)**. Use the **Q (QUAL)** and **Q (ISO)** buttons to zoom in and out and scroll the image with the multi selector. The histogram will be updated to show only the data for the portion of the image visible in the monitor.



Histograms

Camera histograms are intended as a guide only and may differ from those displayed in imaging applications. Some sample histograms are shown below:

If the image contains objects with a wide range of brightnesses, the distribution of tones will be relatively even.



If the image is dark, tone distribution will be shifted to the left.

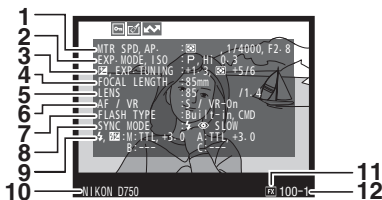


If the image is bright, tone distribution will be shifted to the right.

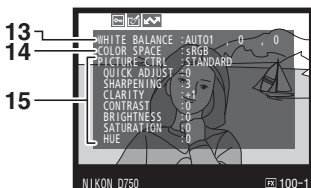


Increasing exposure compensation shifts the distribution of tones to the right, while decreasing exposure compensation shifts the distribution to the left. Histograms can provide a rough idea of overall exposure when bright ambient lighting makes it difficult to see photographs in the monitor.

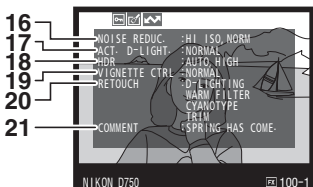
■ Shooting Data



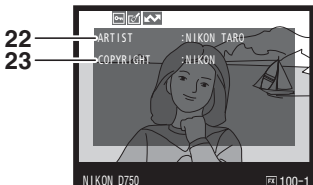
1 Metering	139	7 Flash type	180, 433
Shutter speed	90, 93	Commander mode	348
Aperture	91, 93	8 Flash mode	181, 183
2 Shooting mode	6	9 Flash control	347, 435, 437
ISO sensitivity ¹	134	Flash compensation	188
3 Exposure compensation	143	10 Camera name	
Optimal exposure tuning ²	336	11 Image area	110
4 Focal length	235, 432	12 Folder number—frame	
5 Lens data	235	number	311
6 Focus mode	57, 121, 132		
Lens VR (vibration reduction) ³			



13 White balance	145	14 Color space	314
Color temperature	152	15 Picture Control ⁴	165
White balance fine-tuning	149		
Preset manual	155		



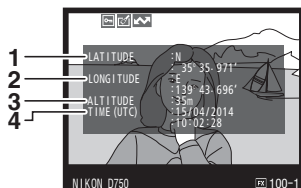
16	High ISO noise reduction.....	317	19	Vignette control.....	315
17	Long exposure noise reduction.....	317	20	Retouch history.....	393
18	Active D-Lighting	175	21	Image comment	384
18	HDR strength	177			



22	Name of photographer ⁵	385	23	Copyright holder ⁵	385
-----------	---	-----	-----------	-------------------------------------	-----

- 1 Displayed in red if photo was taken with auto ISO sensitivity control on.
- 2 Displayed if Custom Setting b6 (**Fine-tune optimal exposure**, □ 336) has been set to a value other than zero for any metering method.
- 3 Displayed only if VR lens is attached.
- 4 Items displayed vary with Picture Control selected.
- 5 The fourth page of the shooting data is only displayed if copyright information was recorded with the photograph as described on page 385.

Location Data* (📖 239)



1 Latitude

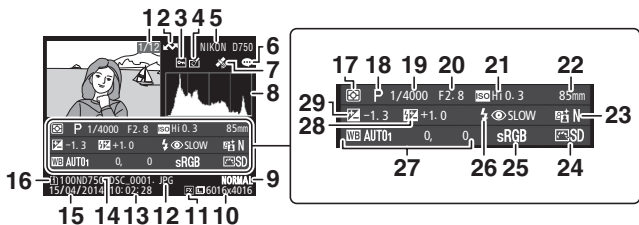
2 Longitude

3 Altitude

4 Coordinated Universal Time (UTC)

* Data for movies are for start of recording.


Overview Data

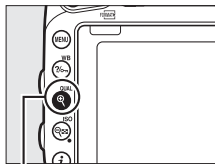


1 Frame number/total number of images	16 Current card slot 119
2 Upload marking 290	17 Metering 139
3 Protect status 257	18 Shooting mode 6
4 Retouch indicator 393	19 Shutter speed 90, 93
5 Camera name	20 Aperture 91, 93
6 Image comment indicator 384	21 ISO sensitivity* 134
7 Location data indicator 239	22 Focal length 235, 432
8 Histogram showing the distribution of tones in the image (1/250).	23 Active D-Lighting 175
9 Image quality 115	24 Picture Control 165
10 Image size 118	25 Color space 314
11 Image area 110	26 Flash mode 181, 183
12 File name 313	27 White balance 145
13 Time of recording 28, 381	Color temperature 152
14 Folder name 311	White balance fine-tuning ... 149
15 Date of recording 28, 381	Preset manual 155
	28 Flash compensation 188
	Commander mode 348
	29 Exposure compensation 143






* Displayed in red if photo was taken with auto ISO sensitivity control on.

Taking a Closer Look: Playback Zoom






Press the  (**QUAL**) button to zoom in on the image displayed in full-frame playback. The following operations can be performed while zoom is in effect:



 (**QUAL**) button

To	Use	Description
Zoom in or out	 (QUAL)/  (ISO)	Press  (QUAL) to zoom 36 × 24 (3 : 2) format images in to maximum of approximately 38 × (large images), 28 × (medium images) or 19 × (small images). Press  (ISO) to zoom out. While photo is zoomed in, use multi selector to view areas of image not visible in monitor. Keep multi selector pressed to scroll rapidly to other areas of frame. Navigation window is displayed when zoom ratio is altered; area currently visible in monitor is indicated by yellow border. Bar under navigation window shows zoom ratio; turns green at ratio of 1 : 1.
View other areas of image		



To	Use	Description
Select faces		Faces detected during zoom are indicated by white borders in navigation window. Rotate sub-command dial to view other faces. 
View other images		Rotate main command dial to view same location in other photos at current zoom ratio. Playback zoom is cancelled when a movie is displayed.
Return to shooting mode		Press the shutter-release button halfway or press the  button to exit to shooting mode.

Protecting Photographs from Deletion

In full-frame, zoom, thumbnail, and calendar playback, press the **WB** button to protect the current picture from accidental deletion. Protected files are marked with a **WB** icon and can not be deleted using the **FORMAT** button or the **Delete** option in the playback menu. Note that protected images *will* be deleted when the memory card is formatted (see 375). To remove protection from a picture so that it can be deleted, display or highlight it and press the **WB** button.




WB button

Removing Protection from All Images


To remove protection from all images in the folder or folders currently selected in the **Playback folder** menu, press the **WB** and **FORMAT** buttons together for about two seconds during playback.

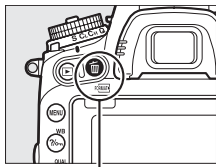
Deleting Photographs


To delete the photograph displayed in full-frame playback or highlighted in the thumbnail list, press the  (FORMAT) button. To delete multiple selected photographs, all photographs taken on a selected date, or all photographs in the current playback folder, use the **Delete** option in the playback menu. Once deleted, photographs can not be recovered. Note that pictures that are protected or hidden can not be deleted.




Full-Frame, Thumbnail, and Calendar Playback

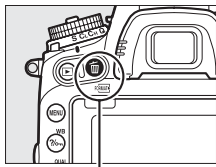
Press the  (FORMAT) button to delete the current photograph.


- 1 Press the  (FORMAT) button.**
A confirmation dialog will be displayed.





 (FORMAT) button

- 2 Press the  (FORMAT) button again.**
To delete the photograph, press the  (FORMAT) button. To exit without deleting the photograph, press the  button.




 (FORMAT) button

Calendar Playback



During calendar playback, you can delete all photographs taken on a selected date by highlighting the date in the date list and pressing the  (FORMAT) button ( 244).

See Also

The **After delete** option in the playback menu determines whether the next image or the previous image is displayed after an image is deleted ( 307).

The Playback Menu



The **Delete** option in the playback menu contains the following options. Note that depending on the number of images, some time may be required for deletion.

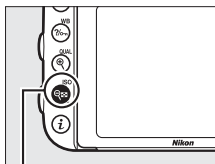
Option	Description
 Selected	Delete selected pictures.
 Select date	Delete all pictures taken on a selected date (📅 261).
ALL All	Delete all pictures in the folder currently selected for playback (📁 300). If two cards are inserted, you can select the card from which pictures will be deleted.




■ Selected: Deleting Selected Photographs

1 Select pictures.

Use the multi selector to highlight a picture and press the  (ISO) button to select or deselect. Selected pictures are marked by a  icon. Repeat as desired to select additional pictures.



 (ISO) button



2 Delete the selected pictures.

Press **OK**. A confirmation dialog will be displayed; highlight **Yes** and press **OK**.



■ ■ Select Date: Deleting Photographs Taken on a Selected Date

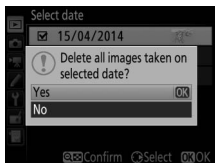
1 Select dates.

Highlight a date and press **▶** to select all pictures taken on the highlighted date. Selected dates are marked with a icon. Repeat as desired to select additional dates; to deselect a date, highlight it and press **▶**.



2 Delete the selected pictures.

Press **OK**. A confirmation dialog will be displayed; highlight **Yes** and press **OK**.



Connections

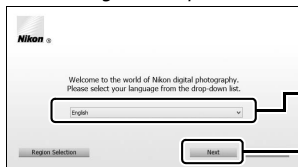
Installing ViewNX 2

Install the supplied software to display and edit photographs and movies that have been copied to your computer. Before installing ViewNX 2, confirm that your computer meets the system requirements on page 264. Be sure to use the latest version of ViewNX 2, which is available for download from the websites listed on page xxiii, as earlier versions that do not support the D750 may fail to transfer NEF (RAW) images correctly.

1 Launch the installer.

Start the computer, insert the installer CD, and launch the installer. A language selection dialog will be displayed. If the desired language is not available, click **Region Selection** to choose a different region (region selection is not available in the European release).

① *Select region (if required)*



② *Select language*

③ *Click **Next***

2 Start the installer.

Click **Install** and follow the on-screen instructions.



*Click **Install***

3 Exit the installer.



*Click **Yes***



*Click **OK***

4 Remove the installer CD from the CD-ROM drive.

Viewing the Nikon Website

To visit the Nikon website after installing ViewNX 2, select **All Programs > Link to Nikon** from the Windows start menu (Internet connection required).

System Requirements

Windows

CPU	<ul style="list-style-type: none">• Photos: Intel Celeron, Pentium 4, or Core series, 1.6 GHz or better• Movies (playback): Pentium D 3.0 GHz or better; Intel Core i5 or better recommended when viewing movies with a frame size of 1280 × 720 or more at a frame rate of 30 fps or above or movies with a frame size of 1920 × 1080 or more• Movies (editing): Intel Core i5 or better
OS*	Pre-installed versions of Windows 8.1, Windows 7, and Windows Vista
Memory (RAM)	<ul style="list-style-type: none">• 32-bit Windows 8.1, Windows 7, or Windows Vista: 1 GB or more (2 GB or more recommended)• 64-bit Windows 8.1, Windows 7, or Windows Vista: 2 GB or more (4 GB or more recommended)
Hard disk space	A minimum of 1 GB available on the startup disk (3 GB or more recommended)
Graphics	<ul style="list-style-type: none">• Resolution: 1024 × 768 pixels (XGA) or more (1280 × 1024 pixels or more recommended)• Color: 24-bit color (True Color) or more
Interface	Built-in USB port required. Software may not function as expected if camera is connected via USB hub.

* See the websites listed on page xxiii for the latest information on supported operating systems.

Mac	
CPU	<ul style="list-style-type: none"> • Photos: Intel Core or Xeon series • Movies (playback): Core Duo 2 GHz or better; Intel Core i5 or better recommended when viewing movies with a frame size of 1280 × 720 or more at a frame rate of 30 fps or above or movies with a frame size of 1920 × 1080 or more • Movies (editing): Intel Core i5 or better
OS *	OS X 10.9, 10.8, or 10.7
Memory (RAM)	2 GB or more (4 GB or more recommended)
Hard disk space	A minimum of 1 GB available on the startup disk (3 GB or more recommended)
Graphics	<ul style="list-style-type: none"> • Resolution: 1024 × 768 pixels (XGA) or more (1280 × 1024 pixels or more recommended) • Color: 24-bit color (millions of colors) or more
Interface	Built-in USB port required. Software may not function as expected if camera is connected via USB hub.

* See the websites listed on page xxiii for the latest information on supported operating systems.

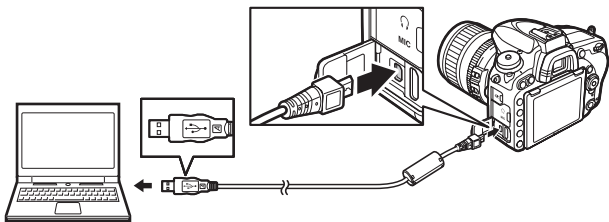
Using ViewNX 2

Copy Pictures to the Computer

Before proceeding, be sure you have installed the software on the supplied ViewNX 2 CD (☞ 262).

1 Connect the USB cable.

After turning the camera off and ensuring that a memory card is inserted, connect the supplied USB cable as shown and then turn the camera on.



✔ Use a Reliable Power Source

To ensure that data transfer is not interrupted, be sure the camera battery is fully charged.

✔ Connecting Cables

Be sure the camera is off when connecting or disconnecting interface cables. Do not use force or attempt to insert the connectors at an angle.

✔ During Transfer

Do not turn the camera off or disconnect the USB cable while transfer is in progress.

✔ USB Hubs

Connect the camera directly to the computer; do not connect the cable via a USB hub or keyboard.

2 Start Nikon Transfer 2 component of ViewNX 2.

If a message is displayed prompting you to choose a program, select Nikon Transfer 2.

Windows 7

If the following dialog is displayed, select Nikon Transfer 2 as described below.

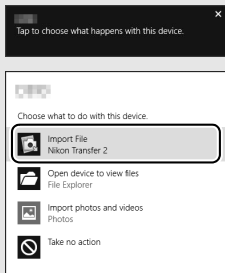
- 1 Under **Import pictures and videos**, click **Change program**. A program selection dialog will be displayed; select **Import File using Nikon Transfer 2** and click **OK**.

- 2 Double-click **Import File**.



Windows 8.1

Windows 8.1 may display an AutoPlay prompt when the camera is connected. Tap or click the dialog and then tap or click **Import File/Nikon Transfer 2** to select Nikon Transfer 2.



3 Click **Start Transfer**.

At default settings, pictures on the memory card will be copied to the computer.



Start Transfer

4 Terminate the connection.

When transfer is complete, turn the camera off and disconnect the USB cable.

Starting ViewNX 2 Manually

- Windows: Double-click the ViewNX 2 shortcut on the desktop.
- Mac: Click the ViewNX 2 icon in the Dock.

For More Information

Consult online help for more information on using ViewNX 2.

Capture NX-D

Use Nikon's Capture NX-D software to retouch photos or to change settings for NEF (RAW) pictures and save them in other formats. Capture NX-D also offers an Image Dust Off feature that removes image artifacts caused by dust inside the camera. Capture NX-D is available for download from a link in the ViewNX 2 installer (☞ 262).

Ethernet and Wireless Networks

The optional UT-1 communication unit (□ 442) can be used to upload photographs to a computer or ftp server. The camera connects to the UT-1 using the USB cable supplied with the camera, while the UT-1 in turn connects to the network via an Ethernet cable or an optional WT-5 wireless transmitter (□ 442). The optional communication units and wireless transmitters support the following modes:

Mode	Function
FTP upload	Upload existing photos and movies to a computer or ftp server, or upload new photos as they are taken.
Image transfer	
Camera control	Control the camera using optional Camera Control Pro 2 software and save new photos and movies directly to the computer.
HTTP server	View and take pictures remotely using a browser equipped computer or iPhone.

For information on using optional communication units or wireless transmitters, refer to the manuals provided with the device. Be sure to update to the latest versions of the device firmware and related software.

✔ Image Upload

Once a connection has been established to the UT-1, the **i** button functions during playback to select pictures for upload in ftp and image transfer modes (upload only takes place when the UT-1 is connected). Other playback operations that use the **i** button, such as **Side-by-side comparison** (☐ 419), can not be performed. To restore normal operation, delete the network profile as described in the UT-1 manual.

✔ During Transfer

Movies can not be recorded or played back when the UT-1 is connected and there are either images remaining to be sent or images currently being transferred via an Ethernet or wireless network.

✍ Movies

Movies can be uploaded over Ethernet and wireless networks in transfer mode. Note, however, that movies can not be uploaded using the **Auto send** or **Send folder** features in the **Options** menu.

✔ HTTP Server Mode

The camera can not be used to record or view movies in HTTP server mode.

✍ WT-5 Wireless Transmitters

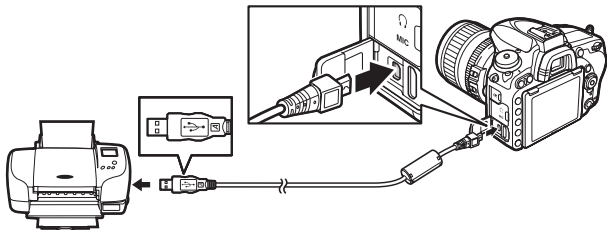
The principal differences between the WT-5 and WT-5A/B/C/D/E is in the number of channels supported; unless otherwise stated, all references to the the WT-5 also apply to the WT-5A/B/C/D/E.

Printing Photographs

Selected JPEG images can be printed on a PictBridge printer (📖 488) connected directly to the camera.

Connecting the Printer

Connect the camera using the supplied USB cable. Do not use force or attempt to insert the connectors at an angle.



When the camera and printer are turned on, a welcome screen will be displayed in the monitor, followed by a PictBridge playback display.

USB Hubs

Connect the camera directly to the printer; do not connect the cable via a USB hub.

Selecting Photographs for Printing

NEF (RAW) photographs (📖 115) can not be selected for printing. JPEG copies of NEF (RAW) images can be created using the **NEF (RAW) processing** option in the retouch menu (📖 406).

Printing Via Direct USB Connection

Be sure the battery is fully charged or use an optional AC adapter and power connector. When taking photographs to be printed via direct USB connection, set **Color space** to **sRGB** (📖 314).

Printing Pictures One at a Time

1 Display the desired picture.

Press \leftarrow or \rightarrow to view additional pictures. Press the \mathcal{Q} (**QUAL**) button to zoom in on the current frame (press \square to exit zoom). To view thumbnails, press the \mathcal{I} (**ISO**) button. Use the multi selector to highlight pictures, or press \mathcal{I} (**ISO**) again to display the highlighted picture full frame.

2 Adjust printing options.

Press OK to display the following items, then press \uparrow or \downarrow to highlight an item and press \rightarrow to view options (only options supported by the current printer are listed; to use the default option, select **Printer default**). After selecting an option, press OK to return to the printer settings menu.

Option	Description
Page size	Choose a page size.
No. of copies	This option is listed only when pictures are printed one at a time. Press \uparrow or \downarrow to choose number of copies (maximum 99).
Border	Choose whether to frame photos in white borders.
Time stamp	Choose whether to print the times and dates of recordings on photos.
Cropping	This option is listed only when pictures are printed one at a time. To exit without cropping, highlight No cropping and press OK . To crop the current picture, highlight Crop and press \rightarrow . A crop selection dialog will be displayed; press \mathcal{Q} (QUAL) to increase the size of the crop, \mathcal{I} (ISO) to decrease, and use the multi selector to position the crop. Note that print quality may drop if small crops are printed at large sizes.

3 Start printing.

Select **Start printing** and press **OK** to start printing. To cancel before all copies have been printed, press **OK**.

 **See Also**

See page 476 for information on what to do if an error occurs during printing.












Printing Multiple Pictures

1 Display the PictBridge menu.

Press the MENU button in the PictBridge playback display.

2 Choose an option.

Highlight one of the following options and press .

- **Print select:** Select pictures for printing. Use the multi selector to highlight pictures (to display the current picture full screen, press and hold the /QUAL button) and, keeping the  (ISO) button pressed, press  or  to choose the number of prints (maximum 99). To deselect a picture, set the number of prints to zero.
- **Select date:** Print one copy of all the pictures taken on selected dates. Press  or  to highlight dates and press  to select or deselect. To view the pictures taken on the selected date, press  (ISO). Use the multi selector to scroll through the pictures, or press and hold  (QUAL) to view the current picture full screen. Press  (ISO) again to return to the date selection dialog.
- **Print (DPOF):** Print the current DPOF print order ( 275). The order can be viewed and modified before printing as described in the description for **Print select**, above.
- **Index print:** To create an index print of all JPEG pictures on the memory card, proceed to Step 3. Note that if the memory card contains more than 256 pictures, only the first 256 images will be printed. A warning will be displayed if the page size selected in Step 3 is too small for an index print.

3 Adjust printing options.

Adjust printer settings as described in Step 2 on page 272.

4 Start printing.

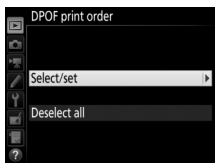
Select **Start printing** and press **OK** to start printing. To cancel before all copies have been printed, press **OK**.

Creating a DPOF Print Order: Print Set

The **DPOF print order** option in the playback menu is used to create digital “print orders” for PictBridge-compatible printers and devices that support DPOF (□ 488).

1 Choose DPOF print order > Select/set.

Select **DPOF print order** in the playback menu, then highlight **Select/set** and press **▶** (to remove all photographs from the print order, select **Deselect all**).




2 Select pictures.

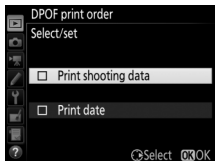
Use the multi selector to scroll through the pictures on (to display the current picture full screen, press and hold the **Q/QUAL** button) and keeping the **ISO** button pressed, press **▲** or **▼** to choose the number of prints (maximum 99). To deselect a picture, set the number of prints to zero. Press **OK** when all the desired pictures have been selected.



3 Select imprint options.

Highlight the following options and press  to toggle the highlighted option on or off.

- **Print shooting data:** Print shutter speed and aperture on all pictures in print order.
- **Print date:** Print date of recording on all pictures in print order.



4 Complete the print order.

Press  to complete the print order.

DPOF Print Order

To print the current print order when the camera is connected to a PictBridge printer, select **Print (DPOF)** in the PictBridge menu and follow the steps in “Printing Multiple Pictures” to modify and print the current order (□ 274). DPOF print date and shooting data options are not supported when printing via direct USB connection; to print the date of recording on photographs in the current print order, use the PictBridge **Time stamp** option.

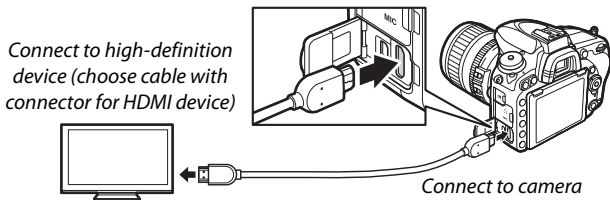
The **DPOF print order** option can not be used if there is not enough space on the memory card to store the print order.


NEF (RAW) photographs (□ 115) can not be selected using this option. JPEG copies of NEF (RAW) images can be created using the **NEF (RAW) processing** option in the retouch menu (□ 406).

Print orders may not print correctly if images are deleted using a computer or other device after the print order is created.

Viewing Photographs on TV

The optional High-Definition Multimedia Interface (HDMI) cable (📖 442) or a type C HDMI cable (available separately from third-party suppliers) can be used to connect the camera to high-definition video devices. Always turn the camera off before connecting or disconnecting an HDMI cable.



Tune the device to the HDMI channel, then turn the camera on and press the  button. During playback, images will be displayed on the television screen. Volume can be adjusted using television controls; the camera controls can not be used.

Television Playback

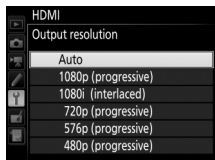
Use of an AC adapter and power connector (available separately) is recommended for extended playback. If the edges of photographs are not visible in the television display, select **95%** for **HDMI > Advanced > Output display size** (📖 279).

HDMI Options

The **HDMI** option in the setup menu (📖 374) controls output resolution and other advanced HDMI options, and can also be used to enable the camera for remote control from devices that support HDMI-CEC (High-Definition Multimedia Interface–Consumer Electronics Control, a standard that allows HDMI devices to be used to control peripherals to which they are connected).

■ *Output Resolution*

Choose the format for images output to the HDMI device. If **Auto** is selected, the camera will automatically select the appropriate format.



■ *Device Control*

If **On** is selected for **HDMI > Device control** when the camera is connected to a television that supports HDMI-CEC and both the camera and television are on, the television remote can be used in place of the camera multi selector and ⓧ button during full-frame playback and slide shows. If **Off** is selected, the television remote can not be used to control the camera.

■ ■ *Advanced*

Option	Description
Output range	<p>Auto is recommended in most situations. If the camera is unable to determine the correct RGB video signal output range for the HDMI device, you can choose from the following options:</p> <ul style="list-style-type: none">• Limited range: For devices with an RGB video signal input range of 16 to 235. Choose this option if you notice loss of detail in shadows.• Full range: For devices with an RGB video signal input range of 0 to 255. Choose this option if shadows are “washed out” or too bright.
Output display size	Choose horizontal and vertical frame coverage for HDMI output from 95% or 100%.
Live view on-screen display	If Off is selected when the camera is connected to an HDMI device, shooting information will not be displayed in the monitor during live view photography.
Dual monitor	Choose On to mirror the HDMI display on the camera monitor, Off to turn the camera monitor off to save power. Dual monitor turns on automatically when Live view on-screen display is Off .

HDMI and Live View

When the camera is connected via an HDMI cable, HDMI displays can be used for live view photography and movie live view (□ 65, 78). Note that if **1920 × 1080; 60p** is selected for the **Frame size/frame rate** in the movie shooting menu (□ 319), the selected setting will only be reflected in the HDMI output during movie recording if all the following conditions are met: **Auto** or **1080p (progressive)** is selected for **HDMI > Output resolution, 100%** is selected for **HDMI > Advanced > Output display size**, and **Off** is selected for **HDMI > Advanced > Live view on-screen display** (□ 279). At other settings, the output resolution, display size, or frame rate may differ from that selected in the camera menus.

HDMI-CEC Devices

When the camera is connected to an HDMI-CEC device, **ⓧ ⓧ ⓧ** will appear in the control panel in place of the number of exposures remaining.

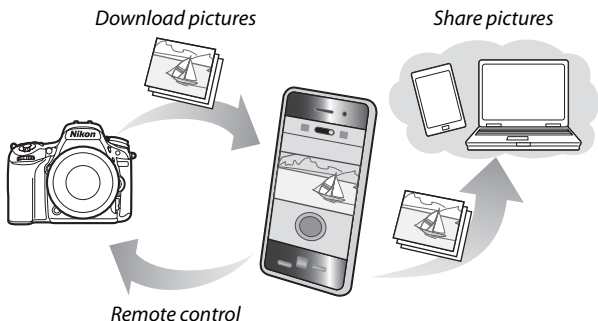
Device Control

See the television manual for details.

Wi-Fi

What Wi-Fi Can Do for You

The camera can connect via Wi-Fi wireless networks to a smart device running Nikon's dedicated Wireless Mobile Utility app. The smart device can be used to control the camera and take pictures remotely, or pictures can be downloaded from the camera to the smart device and shared with others on the Internet. Pictures can also be uploaded from the camera to the smart device (📖 289).



See the Wireless Mobile Utility manual for details (📖 283).

📌 Wi-Fi

Wi-Fi is available with the D750 only. The D750 (K) does not support Wi-Fi.

Accessing the Camera

Before connecting via Wi-Fi (wireless LAN), install the Wireless Mobile Utility on your Android or iOS smart device. Instructions for accessing the camera vary with the type of connection used by the smart device.

Android

- **Push-button WPS:** If the smart device supports push-button WPS (i.e., has a **WPS button connection** option in its **Wi-Fi settings** menu), you can use this easy method to connect to the smart device (📖 284)
- **PIN-entry WPS:** If the smart device supports WPS, you can use the camera to establish a connection by entering the PIN displayed by the smart device (📖 285)
- **View SSID:** If the smart device does not support WPS, you can connect by selecting the camera SSID on the smart device (📖 286)

iOS

- **View SSID:** Connect by selecting the camera SSID on the smart device (📖 286)

WPS

WPS (Wi-Fi Protected Setup) is a standard designed to make it easy to establish a secure wireless network. For information on the steps involved and the length of time the smart device will wait for a connection, see the documentation supplied with the smart device.

Installing the Wireless Mobile Utility App

1 Find the app.

On the smart device, connect to the Google Play service, the App Store, or another app marketplace and search for “Wireless Mobile Utility”. For more information, see the instructions provided with the smart device.

2 Install the app.

Read the app description and install the app. A pdf manual for the Wireless Mobile Utility is available for download at the following URLs:

- **Android:** <http://nikonimglib.com/ManDL/WMAU/>

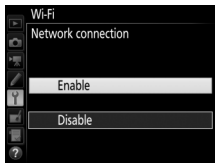
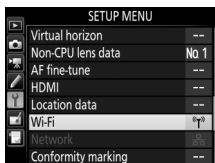


- **iOS:** <http://nikonimglib.com/ManDL/WMAU-ios/>



WPS (Android Only)

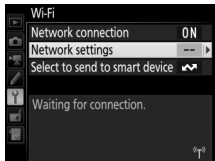
- 1 Enable the camera's built-in Wi-Fi.**
Highlight **Wi-Fi** in the setup menu and press **▶**. Highlight **Network connection** and press **▶**, then highlight **Enable** and press **OK**. Wait a few seconds for Wi-Fi to activate.



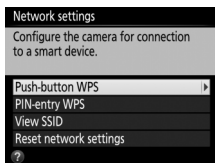
2 Connect.

Enable WPS button connections on the camera and smart device:

- **Camera:** Highlight **Network settings** and press **▶**.



Highlight **Push-button WPS** and press **▶** to ready the camera for a WPS connection. The camera will wait about two minutes for a WPS connection request from the smart device. To extend the wait time, press **OK**.



- **Smart device:** Select **Wi-Fi settings > WPS button connection**.

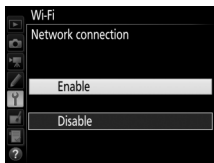
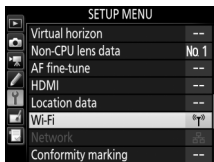
3 Launch the Wireless Mobile Utility.

Launch the Wireless Mobile Utility on the smart device. The main dialog will be displayed.

PIN Entry (Android Only)

1 Enable the camera's built-in Wi-Fi.

Highlight **Wi-Fi** in the setup menu and press **Enter**. Highlight **Network connection** and press **Enter**, then highlight **Enable** and press **OK**. Wait a few seconds for Wi-Fi to activate.

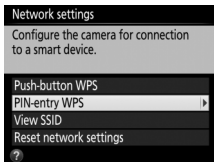


2 Select Network settings > PIN-entry WPS.






Highlight **Network settings** and press **Enter**.



Highlight **PIN-entry WPS** and press **Enter**.



3 Enter the PIN.




Enter the PIN displayed by the smart device. Press  or  to highlight digits and press  or  to change. Press  when entry is complete.

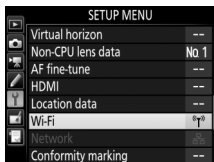
4 Launch the Wireless Mobile Utility.


Launch the Wireless Mobile Utility on the smart device. The main dialog will be displayed.

SSID (Android and iOS)

1 Enable the camera's built-in Wi-Fi.

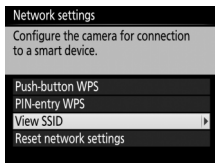
Highlight **Wi-Fi** in the setup menu and press . Highlight **Network connection** and press , then highlight **Enable** and press . Wait a few seconds for Wi-Fi to activate.



-
- 2 Display the camera SSID.**
Highlight **Network settings** and press .



Highlight **View SSID** and press .



-
- 3 Select the camera SSID.**
Select the camera SSID in the list of networks displayed by the smart device.

-
- 4 Launch the Wireless Mobile Utility.**
Launch the Wireless Mobile Utility on the smart device. The main dialog will be displayed.

■ Terminating the Connection

Wi-Fi can be disabled by:

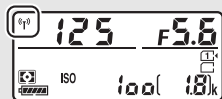
- Selecting **Wi-Fi > Network connection > Disable** in the camera setup menu
- Starting movie recording
- Connecting an optional UT-1 communication unit
- Turning the camera off

■ Restoring Default Settings

To restore default network settings, select **Wi-Fi > Network settings > Reset network settings**. A confirmation dialog will be displayed; highlight **Yes** and press **OK** to restore default network settings.

🔍 The Wi-Fi Display

While Wi-Fi is enabled, a **(Wi-Fi)** icon will flash in the control panel. The icon will stop flashing once a connection has been established and the camera is exchanging data with the smart device.



✔ Wi-Fi

Read the warnings on pages xxiv to xxvi before using the Wi-Fi function. To disable Wi-Fi in settings in which its use is prohibited, select **Wi-Fi > Network connection > Disable** in the camera setup menu. Note that Eye-Fi cards can not be used while Wi-Fi is enabled and that the standby timer will not turn off while the Wireless Mobile Utility app on the smart device is communicating with the camera. If no data are exchanged for about 5 minutes, the standby timer will turn off. The camera Wi-Fi function is only available when a memory card is inserted and can not be used when a USB or HDMI cable is connected. To prevent loss of power while connected, charge the battery before enabling the network connection.

Selecting Pictures for Upload

Follow the steps below to select photos for upload to the smart device. Movies can not be selected for upload.

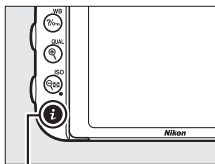
Selecting Individual Pictures for Upload

1 Select an image.

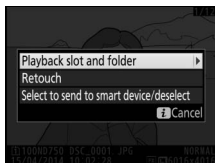
Display the image or highlight it in the thumbnail list in thumbnail or calendar playback.

2 Display playback options.

Press the **i** button.




i button



3 Choose **Select to send to smart device/deselect**.

Highlight **Select to send to smart device/deselect** and press **OK**.


Pictures selected for upload are indicated by a  icon; to deselect, display or highlight the image and repeat Steps 2 and 3.



Selecting Multiple Pictures for Upload




To change the upload status of multiple pictures, use the **Wi-Fi > Select to send to smart device** option in the setup menu.

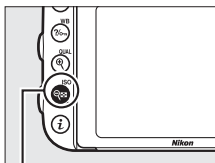
1 Choose **Select to send to smart device**.


Select **Wi-Fi** in the setup menu, then highlight **Select to send to smart device** and press .

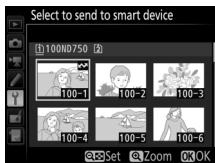


2 Select pictures.

Use the multi selector to highlight pictures and press  (**ISO**) to select or deselect (to view the highlighted picture full screen, press and hold the  button). Selected pictures are marked by a  icon.



 (**ISO**) button



3 Press .

Press  to complete the operation.

Menu Guide

Defaults

The default settings for the options in the camera menus are listed below. For information on two-button resets, see page 199.

■ Playback Menu Defaults

Option	Default
Playback folder (☐ 300)	ND750
Image review (☐ 307)	Off
After delete (☐ 307)	Show next
Rotate tall (☐ 308)	On
Slide show (☐ 308)	
Image type (☐ 308)	Still images and movies
Frame interval (☐ 308)	2 s

■ Photo Shooting Menu Defaults ¹

Option	Default
File naming (☐ 313)	DSC
Role played by card in Slot 2 (☐ 119)	Overflow
Image quality (☐ 115)	JPEG normal
Image size (☐ 118)	Large
Image area (☐ 110)	
Choose image area (☐ 111)	FX (36×24)
Auto DX crop (☐ 111)	On
JPEG compression (☐ 117)	Size priority
NEF (RAW) recording (☐ 117)	
Type (☐ 117)	Lossless compressed
NEF (RAW) bit depth (☐ 117)	14-bit

Option	Default
Interval timer shooting (☐ 222)	
Start options (☐ 223)	Now
Interval (☐ 223)	1 min.
No. of intervals×shots/interval (☐ 224)	0001×1
Exposure smoothing (☐ 224)	Off

- 1 Default settings restored with **Reset photo shooting menu** (☐ 311).
- 2 **Reset photo shooting menu** can not be selected while shooting is in progress.

■■ Movie Shooting Menu Defaults *

Option	Default
File naming (☐ 313)	DSC
Destination (☐ 319)	Slot 1
Frame size/frame rate (☐ 319)	1920×1080; 60p
Movie quality (☐ 320)	Normal
Microphone sensitivity (☐ 320)	Auto sensitivity
Frequency response (☐ 320)	Wide range
Wind noise reduction (☐ 321)	Off
Image area (☐ 76)	
Choose image area (☐ 111)	FX (36×24)
Auto DX crop (☐ 111)	On
White balance (☐ 321)	
Fine-tuning (☐ 149)	A-B: 0, G-M: 0
Choose color temp. (☐ 152)	5000 K
Preset manual (☐ 155)	d-1
Set Picture Control (☐ 321)	
High ISO NR (☐ 317)	Normal
Movie ISO sensitivity settings (☐ 322)	
ISO sensitivity (mode M) (☐ 322)	100
Auto ISO control (mode M) (☐ 322)	Off
Maximum sensitivity (☐ 322)	12800

Option	Default
Time-lapse photography (☐ 229)	
Interval (☐ 230)	5 s
Shooting time (☐ 230)	25 minutes
Exposure smoothing (☐ 231)	On



* Default settings restored with **Reset movie shooting menu** (☐ 318).

■ Custom Settings Menu Defaults *

Option	Default
a1 AF-C priority selection (☐ 326)	Release
a2 AF-S priority selection (☐ 327)	Focus
a3 Focus tracking with lock-on (☐ 328)	3 (Normal)
a4 Focus point illumination (☐ 329)	
Manual focus mode	On
Dynamic-area AF display	Off
Group-area AF illumination	☒ (Squares)
a5 AF point illumination (☐ 329)	Auto
a6 Focus point wrap-around (☐ 330)	No wrap
a7 Number of focus points (☐ 330)	51 points
a8 Store points by orientation (☐ 331)	No
a9 Built-in AF-assist illuminator (☐ 332)	On
b1 ISO sensitivity step value (☐ 333)	1/3 step
b2 EV steps for exposure cntrl (☐ 333)	1/3 step
b3 Easy exposure compensation (☐ 334)	Off
b4 Matrix metering (☐ 335)	Face detection on
b5 Center-weighted area (☐ 335)	ø 12 mm
b6 Fine-tune optimal exposure (☐ 336)	
Matrix metering	0
Center-weighted metering	0
Spot metering	0
Highlight-weighted metering	0

	Option	Default
c1	Shutter-release button AE-L (☐☐ 336)	Off
c2	Standby timer (☐☐ 336)	6 s
c3	Self-timer (☐☐ 337)	
	Self-timer delay	10 s
	Number of shots	1
	Interval between shots	0.5 s
c4	Monitor off delay (☐☐ 337)	
	Playback	10 s
	Menus	1 min
	Information display	10 s
	Image review	4 s
	Live view	10 min
c5	Remote on duration (ML-L3) (☐☐ 337)	1 min
d1	Beep (☐☐ 338)	
	Volume	Off
	Pitch	Low
d2	Continuous low-speed (☐☐ 338)	3 fps
d3	Max. continuous release (☐☐ 339)	100
d4	Exposure delay mode (☐☐ 339)	Off
d5	Flash warning (☐☐ 339)	On
d6	File number sequence (☐☐ 340)	On
d7	Viewfinder grid display (☐☐ 341)	Off
d8	Easy ISO (☐☐ 341)	Off
d9	Information display (☐☐ 341)	Auto
d10	LCD illumination (☐☐ 342)	Off
d11	MB-D16 battery type (☐☐ 343)	LR6 (AA alkaline)
d12	Battery order (☐☐ 344)	Use MB-D16 batteries first

	Option	Default
e1	Flash sync speed (☐ 345)	1/200 s
e2	Flash shutter speed (☐ 346)	1/60 s
e3	Flash cntrl for built-in flash/Optional flash (☐ 347)	TTL
e4	Exposure comp. for flash (☐ 353)	Entire frame
e5	Modeling flash (☐ 353)	On
e6	Auto bracketing set (☐ 353)	AE & flash
e7	Bracketing order (☐ 354)	MTR > under > over
f1	OK button (☐ 354)	
	Shooting mode (☐ 354)	Select center focus point
	Playback mode (☐ 355)	Thumbnail on/off
	Live view (☐ 355)	Select center focus point
f2	Assign Fn button (☐ 356)	
	Press (☐ 356)	None
	Press + command dials (☐ 360)	Choose image area
f3	Assign preview button (☐ 361)	
	Press (☐ 361)	Preview
	Press + command dials (☐ 361)	None
f4	Assign AE-L/AF-L button (☐ 361)	
	Press (☐ 361)	AE/AF lock
	Press + command dials (☐ 362)	None
f5	Customize command dials (☐ 363)	
	Reverse rotation (☐ 363)	Exposure compensation: <input type="checkbox"/> Shutter speed/aperture: <input type="checkbox"/>
	Change main/sub (☐ 363)	Exposure setting: Off Autofocus setting: Off
	Aperture setting (☐ 364)	Sub-command dial
	Menus and playback (☐ 364)	Off
	Sub-dial frame advance (☐ 364)	10 frames


	Option	Default
f6	Release button to use dial (☐ 365)	No
f7	Slot empty release lock (☐ 365)	Enable release
f8	Reverse indicators (☐ 366)	
f9	Assign movie record button (☐ 366)	
	Press + command dials	None
f10	Assign MB-D16  button (☐ 367)	AE/AF lock
f11	Assign remote (WR) Fn button (☐ 368)	None
g1	Assign Fn button (☐ 370)	
	Press	None
g2	Assign preview button (☐ 372)	
	Press	Index marking
g3	Assign AE-L/AF-L button (☐ 373)	
	Press	AE/AF lock
g4	Assign shutter button (☐ 373)	Take photos

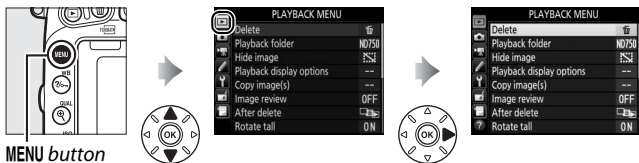
* Default settings restored with **Reset custom settings** (☐ 326).

■ Setup Menu Defaults

Option	Default
Save user settings (☐ 99)	
Save to U1	Shooting mode defaults to P
Save to U2	
Monitor brightness (☐ 376)	0
Monitor color balance (☐ 377)	A-B: 0, G-M: 0
Clean image sensor (☐ 448)	
Clean at startup/shutdown (☐ 449)	Clean at startup & shutdown
Flicker reduction (☐ 380)	Auto
Time zone and date (☐ 381)	
Daylight saving time	Off
Auto image rotation (☐ 382)	On
HDMI (☐ 278)	
Output resolution (☐ 278)	Auto
Device control (☐ 278)	On
Advanced (☐ 279)	
Output range	Auto
Output display size	100%
Live view on-screen display	On
Dual monitor	On
Location data (☐ 239)	
Standby timer	Enable
Set clock from satellite	Yes
Wi-Fi (☐ 282)	
Network connection	Disable
Eye-Fi upload (☐ 391)	Enable

▶ The Playback Menu: *Managing Images*



To display the playback menu, press **MENU** and select the  (playback menu) tab.



MENU button

Playback Menu Options

The playback menu contains the following options:


Option		Option	
Delete	260	Image review	307
Playback folder	300	After delete	307
Hide image	301	Rotate tall	308
Playback display options	302	Slide show	308
Copy image (s)	303	DPOF print order	275

See Also

Menu defaults are listed on page 292.

Playback Folder

MENU button →  playback menu




Choose a folder for playback ( 241):

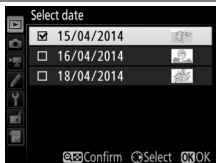
Option	Description
ND750	Pictures in all folders created with the D750 will be visible during playback.
All	Pictures in all folders will be visible during playback.
Current	Only pictures in the current folder will be visible during playback.

Hide Image

MENU button →  playback menu

Hide or reveal pictures. Hidden pictures are visible only in the **Hide image** menu and can only be deleted by formatting the memory card.


Option	Description
Select/set	Hide or reveal selected pictures.
Select date	Selecting this option displays a list of dates. To hide all pictures taken on a date, highlight the date and press  . Selected dates are marked by a ✓; to reveal all pictures taken on a selected date, highlight it and press  . Press  to complete the operation.
Deselect all	Reveal all pictures.

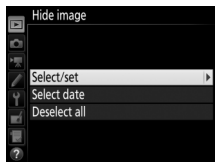


Protected and Hidden Images

Revealing a protected image will also remove protection from the image.

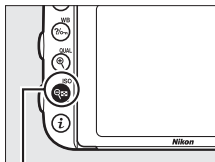
Follow the steps below to hide or reveal selected pictures.

- 1 Choose **Select/set**.**
Highlight **Select/set** and press .



2 Select pictures.

Use the multi selector to scroll through the pictures on the memory card (to view the highlighted picture full screen, press and hold the **Q/QUAL** button) and press **Q/ISO** (ISO) to select the current picture. Selected pictures are marked by a **ISO** icon; to deselect a picture, highlight it and press **Q/ISO** (ISO) again. Continue until all the desired pictures have been selected.



Q/ISO (ISO) button



3 Press **OK**.

Press **OK** to complete the operation.

Playback Display Options

MENU button → **▶** playback menu

Choose the information available in the playback photo information display (246). Press **▲** or **▼** to highlight an option, then press **▶** to select the option for the photo information display. A **✓** appears next to selected items; to deselect, highlight an item and press **▶**. To return to the playback menu, press **OK**.

Copy Image(s)

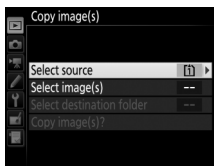
MENU button →  playback menu

Copy pictures from one memory card to another. This option is only available when two memory cards are inserted in the camera.


Option	Description
Select source	Choose card from which pictures will be copied.
Select image(s)	Select pictures to be copied.
Select destination folder	Select destination folder on remaining card.
Copy image(s)?	Copy selected pictures to specified destination.

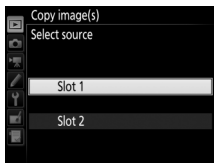
1 Choose **Select source**.

Highlight **Select source** and press .



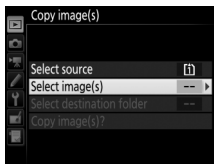
2 Select the source card.

Highlight the slot for the card containing the images to be copied and press .




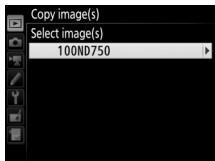
3 Choose **Select image(s)**.

Highlight **Select image(s)** and press .



4 Select the source folder.

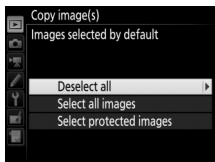
Highlight the folder containing the images to be copied and press .






5 Make the initial selection.

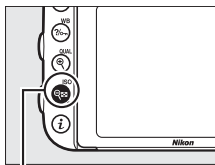
Before going on to select or deselect individual images, you can mark all or all protected images in the folder for copying by choosing **Select all images** or **Select protected images**.


To mark only individually selected images for copying, choose **Deselect all** before proceeding.



6 Select additional images.

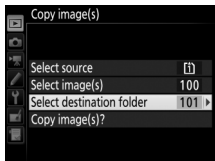
Highlight pictures and press  (ISO) to select or deselect (to view the highlighted picture full screen, press and hold the /QUAL button). Selected images are marked with a ✓. Press  to proceed to Step 7 when your selection is complete.



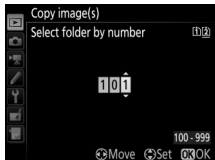
 (ISO) button



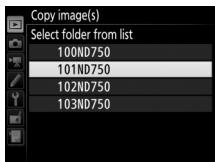
-
- 7 Choose Select destination folder.**
Highlight **Select destination folder** and press **↵**.



-
- 8 Select a destination folder.**
To enter a folder number, choose **Select folder by number**, enter the number (📖 311), and press **ⓄK**. If the folder with the selected number does not already exist, a new folder will be created.

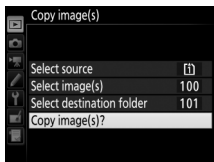


To choose from a list of existing folders, choose **Select folder from list**, highlight a folder, and press **ⓄK**.



9 Copy the images.

Highlight **Copy image(s)?** and press **OK**.



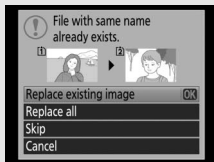
A confirmation dialog will be displayed; highlight **Yes** and press **OK**. Press **OK** again to exit when copying is complete.



✓ Copying Images

Images will not be copied if there is insufficient space on the destination card. Be sure the battery is fully charged before copying movies.


If the destination folder contains an image with the same name as one of the images to be copied, a confirmation dialog will be displayed. Select **Replace existing image** to replace the image with the image to be copied, or select **Replace all** to replace all existing images with the same names without further prompting. To continue without replacing the image, select **Skip**, or select **Cancel** to exit without copying any further images. Hidden or protected files in the destination folder will not be replaced.



Protect status is copied with the images but print marking (📖 275) is not. Hidden images can not be copied.

Image Review




MENU button →  playback menu

Choose whether pictures are automatically displayed in the monitor immediately after shooting. If **Off** is selected, pictures can only be displayed by pressing the  button.

After Delete

MENU button →  playback menu

Choose the picture displayed after an image is deleted.

Option	Description
 Show next	Display following picture. If deleted picture was last frame, previous picture will be displayed.
 Show previous	Display previous picture. If deleted picture was first frame, following picture will be displayed.
 Continue as before	If user was scrolling through pictures in order recorded, following picture will be displayed as described for Show next . If user was scrolling through pictures in reverse order, previous picture will be displayed as described for Show previous .

Rotate Tall

MENU button →  playback menu

Choose whether to rotate “tall” (portrait-orientation) pictures for display during playback. Note that because the camera itself is already in the appropriate orientation during shooting, images are not rotated automatically during image review.

Option	Description
On	“Tall” (portrait-orientation) pictures are automatically rotated for display in the camera monitor. Pictures taken with Off selected for Auto image rotation (□ 382) will be displayed in “wide” (landscape) orientation.
Off	“Tall” (portrait-orientation) pictures are displayed in “wide” (landscape) orientation.

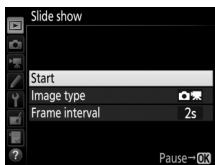
Slide Show

MENU button →  playback menu

Create a slide show of the pictures in the current playback folder (□ 300). Hidden images (□ 301) are not displayed.

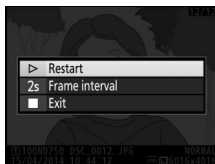
Option	Description
Start	Start slide show.
Image type	Choose type of image displayed from Still images and movies, Still images only , and Movies only .
Frame interval	Choose how long each picture will be displayed.

To start the slide show, highlight **Start** and press **OK**. The following operations can be performed while the slide show is in progress:




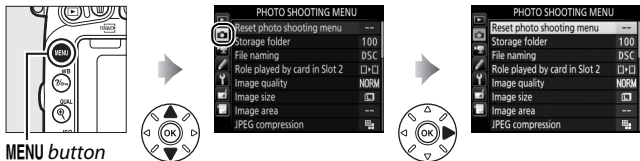
To	Press	Description
Skip back/skip ahead		Press to return to previous frame, to skip to next frame.
View additional photo info		Change or hide photo info displayed (still images only; 246).
Pause	OK	Pause slide show. Select Restart to resume.
Raise/lower volume	QUAL / ISO	Press QUAL during movie playback to increase volume, ISO to decrease.
Exit to playback menu	MENU	End slide show and return to playback menu.
Exit to playback mode		End show and exit to playback mode.
Exit to shooting mode		Press shutter-release button halfway to return to shooting mode.

The dialog shown at right is displayed when the show ends. Select **Restart** to restart or **Exit** to return to the playback menu.



The Photo Shooting Menu: *Photo Shooting Options*

To display the photo shooting menu, press **MENU** and select the  (photo shooting menu) tab.



MENU button

Photo Shooting Menu Options


The photo shooting menu contains the following options:

Option		Option	
Reset photo shooting menu*	311	Color space	314
Storage folder*	311	Active D-Lighting	175
File naming	313	HDR (high dynamic range)	177
Role played by card in Slot 2	119	Vignette control	315
Image quality	115	Auto distortion control	316
Image size	118	Long exposure NR	317
Image area*	110	High ISO NR	317
JPEG compression	117	ISO sensitivity settings	134
NEF (RAW) recording	117	Remote control mode (ML-L3)*	193
White balance	145	Multiple exposure*	216
Set Picture Control	165	Interval timer shooting*	222
Manage Picture Control*	170		

* Not included in the settings saved to **U1** or **U2** (□ 99).


Note: Depending on camera settings, some items may be grayed out and unavailable.

Reset Photo Shooting Menu

MENU button →  photo shooting menu


Select **Yes** to restore photo shooting menu options to their default values (📖 292).

Storage Folder

MENU button →  photo shooting menu








Select the folder in which subsequent images will be stored.




■ Selecting Folders by Folder Number

- 1 Choose Select folder by number.**
Highlight **Select folder by number** and press . The dialog shown at right will be displayed.



- 2 Choose a folder number.**

Press  or  to highlight a digit, press  or  to change. If a folder with the selected number already exists, a , , or  icon will be displayed to the left of the folder number:

-  : Folder is empty.
-  : Folder is partially full.
-  : Folder contains 999 pictures or a picture numbered 9999. No further pictures can be stored in this folder.

The card on which the folder is stored is shown by the card slot icon in the top right corner of the “select folder by number” dialog. The card used for new folders depends on the option currently selected for **Role played by card in slot 2** (📖 119).

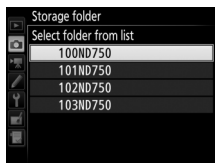
3 Save changes and exit.

Press **OK** to complete the operation and return to the main menu (to exit without choosing the storage folder, press the **MENU** button). If a folder with the specified number does not already exist, a new folder will be created. Subsequent photographs will be stored in the selected folder unless it is already full.

■ ■ *Selecting Folders from a List*

1 Choose **Select folder from list**.

Highlight **Select folder from list** and press **▶**.



2 Highlight a folder.

Press **▲** or **▼** to highlight a folder.

3 Select the highlighted folder.

Press **OK** to select the highlighted folder and return to the main menu. Subsequent photographs will be stored in the selected folder.



✔ Folder and File Numbers

If the current folder is numbered 999 and contains 999 pictures or a picture numbered 9999, the shutter-release will be disabled and no further photographs can be taken. To continue shooting, create a folder with a number less than 999, or select an existing folder with a number less than 999 and less than 999 images.

✔ Startup Time

Additional time may be required for camera startup if the memory card contains a very large number of files or folders.

File Naming

MENU button →  photo shooting menu /  movie shooting menu

Photographs are saved using file names consisting of “DSC_” or, in the case of images that use the Adobe RGB color space, “_DSC”, followed by a four-digit number and a three-letter extension (e.g., “DSC_0001.JPG”). The **File naming** option is used to select three letters to replace the “DSC” portion of the file name. For information on editing file names, see page 171.

✔ Extensions

The following extensions are used: “.NEF” for NEF (RAW) images, “.JPG” for JPEG images, “.MOV” for movies, and “.NDF” for dust off reference data. In each pair of photographs recorded at image-quality settings of NEF (RAW)+JPEG, the NEF and JPEG images have the same file names but different extensions.

The color space determines the gamut of colors available for color reproduction. **sRGB** is recommended for general-purpose printing and display; **Adobe RGB**, with its broader gamut of colors, for professional publication and commercial printing.


Adobe RGB

For accurate color reproduction, Adobe RGB images require applications, displays, and printers that support color management.

Color Space

ViewNX 2 (supplied) and Nikon's Capture NX-D software (□ 268) automatically select the correct color space when opening photographs created with this camera. Results can not be guaranteed with third-party software.

Vignette Control


MENU button →  photo shooting menu

“Vignetting” is a drop in brightness at the edges of a photograph. **Vignette control** reduces vignetting for type G, E, and D lenses (PC lenses excluded). Its effects vary from lens to lens and are most noticeable at maximum aperture. Choose from **High**, **Normal**, **Low**, and **Off**.

Vignette Control

Depending on the scene, shooting conditions, and type of lens, JPEG images may exhibit noise (fog) or variations in peripheral brightness, while custom Picture Controls and preset Picture Controls that have been modified from default settings may not produce the desired effect. Take test shots and view the results in the monitor. Vignette control does not apply to movies (📖 66), multiple exposures (📖 216), or pictures taken with an FX lens and **DX (24 × 16)** selected for **Image area > Choose image area** (📖 111) or with a DX lens, an option other than **DX (24 × 16)** selected for **Choose image area**, and **Off** selected for **Image area > Auto DX crop** (📖 111).

Auto Distortion Control


MENU button →  photo shooting menu

Select **On** to reduce barrel distortion when shooting with wide-angle lenses and to reduce pin-cushion distortion when shooting with long lenses (note that the edges of the area visible in the viewfinder may be cropped out of the final photograph, and that the time needed to process photographs before recording begins may increase). This option does not apply to movies and is available only with type G, E, and D lenses (PC, fisheye, and certain other lenses excluded); results are not guaranteed with other lenses. Before using auto distortion control with DX lenses, select **On** for **Auto DX crop** or choose an image area of **DX (24×16)** as described on page 110; selecting other options may result in heavily cropped photographs or in photographs with severe peripheral distortion.

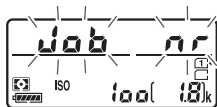
Retouch: Distortion Control

For information on creating copies of existing photographs with reduced barrel and pin-cushion distortion, see page 412.



Long Exposure NR (*Long Exposure Noise Reduction*)

MENU button →  photo shooting menu

If **On** is selected, photographs taken at shutter speeds slower than 1 s will be processed to reduce noise (bright spots, randomly-spaced bright pixels, or fog). The time required for processing roughly doubles; during processing, “**Job nr**” will flash in the shutter speed/aperture displays and pictures can not be taken (if the camera is turned off before processing is complete, the picture will be saved but noise reduction will not be performed). In continuous release mode, frame rates will slow and while photographs are being processed, the capacity of the memory buffer will drop.




High ISO NR

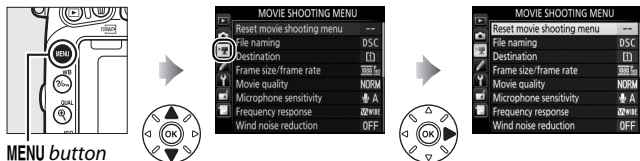
MENU button →  photo shooting menu /  movie shooting menu

Photographs and movies taken at high ISO sensitivities can be processed to reduce “noise.”

Option	Description
High	Reduce noise (randomly-spaced bright pixels), particularly in photographs and movies taken at high ISO sensitivities. Choose the amount of noise reduction performed from High , Normal , and Low .
Normal	
Low	
Off	Noise reduction is performed only as required and never at an amount higher than when Low is selected.

The Movie Shooting Menu: **Movie Shooting Options**

To display the movie shooting menu, press **MENU** and select the  (movie shooting menu) tab.



MENU button

Movie Shooting Menu Options


The movie shooting menu contains the following options:

Option		Option	
Reset movie shooting menu*	318	Image area*	76
File naming	313	White balance	321
Destination	319	Set Picture Control	321
Frame size/frame rate	319	Manage Picture Control*	170
Movie quality	320	High ISO NR	317
Microphone sensitivity	320	Movie ISO sensitivity settings	322
Frequency response	320	Time-lapse photography*	229
Wind noise reduction	321		

* Not included in the settings saved to **U1** or **U2** (☞ 99).


Note: Depending on camera settings, some items may be grayed out and unavailable.

Reset Movie Shooting Menu

MENU button →  movie shooting menu

Select **Yes** to restore movie shooting menu options to their default values (☞ 294).


Destination

MENU button →  movie shooting menu








Choose the slot to which movies are recorded. The menu shows the time available on each card; recording ends automatically when no time remains.



Frame Size/Frame Rate

MENU button →  movie shooting menu

Choose from the following options:

Option ¹	Maximum bit rate (Mbps) (★ high quality/ normal ²)	Maximum length (★ high quality/ normal ²)
 1920 × 1080; 60p	42/24	10 min./20 min.
 1920 × 1080; 50p		
 1920 × 1080; 30p	24/12	20 min./29 min. 59 s
 1920 × 1080; 25p		
 1920 × 1080; 24p		
 1280 × 720; 60p		
 1280 × 720; 50p		


1 Listed values. Actual frame rates for 60p, 50p, 30p, 25p, and 24p are 59.94, 50, 29.97, 25, and 23.976 fps respectively.

2 See page 320.

Frame Size and Rate


Frame size and rate affect the distribution and amount of noise (randomly-spaced bright pixels, fog, or bright spots).

Movie Quality

MENU button →  movie shooting menu


Together with **Frame size/frame rate** (📖 319), **Movie quality** determines the movie recording bit rate and maximum length. Choose from **High quality** and **Normal**.

Microphone Sensitivity

MENU button →  movie shooting menu


Turn the built-in or optional stereo microphones on or off or adjust microphone sensitivity. Choose **Auto sensitivity** to adjust sensitivity automatically, **Microphone off** to turn sound recording off; to select microphone sensitivity manually, select **Manual sensitivity** and choose a sensitivity.



The Icon

 is displayed during playback if the movie was recorded without sound.




Frequency Response

MENU button →  movie shooting menu


If  **Wide range** is selected, the built-in and optional stereo microphones (📖 73) will respond to a wide range of frequencies, from music to the bustling hum of a city street. Choose  **Vocal range** to bring out human voices.

Wind Noise Reduction

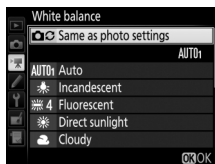
MENU button →  movie shooting menu

Select **On** to enable the low-cut filter for the built-in microphone (optional stereo microphones are unaffected), reducing noise produced by wind blowing over the microphone (note that other sounds may also be affected). Wind-noise reduction for optional stereo microphones can be enabled or disabled using microphone controls.


White Balance

MENU button →  movie shooting menu

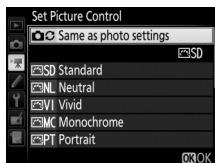
Choose the white balance for movies (📖 145). Select **Same as photo settings** to use the option currently selected for photos.




Set Picture Control

MENU button →  movie shooting menu

Choose a Picture Control for movies (📖 165). Select **Same as photo settings** to use the option currently selected for photos.



Movie ISO Sensitivity Settings

MENU button →  movie shooting menu


Adjust the following ISO sensitivity settings:

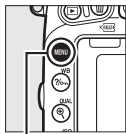
- **ISO sensitivity (mode M):** Choose the ISO sensitivity for mode **M** from values between ISO 100 and Hi 2. Auto ISO sensitivity control is used in other shooting modes.
- **Auto ISO control (mode M):** Select **On** for auto ISO sensitivity control in mode **M**, **Off** to use the value selected for **ISO sensitivity (mode M)**.
- **Maximum sensitivity:** Choose the upper limit for auto ISO sensitivity control from values between ISO 200 and Hi 2. Auto ISO sensitivity control is used in modes **P**, **S**, and **A** and when **On** is selected for **Auto ISO control (mode M)** in exposure mode **M**.

Auto ISO Sensitivity Control

At high ISO sensitivities, the camera may have difficulty focusing and noise (randomly-spaced bright pixels, fog, or lines) may increase. This can be prevented by choosing a lower value for **Movie ISO sensitivity settings > Maximum sensitivity**.

Custom Settings: Fine-Tuning Camera Settings

To display the Custom Settings menu, press **MENU** and select the  (Custom Settings menu) tab.

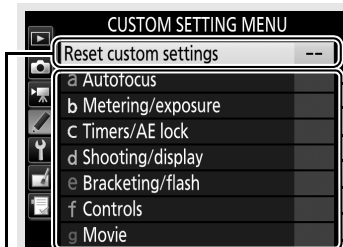


MENU button



Custom Settings are used to customize camera settings to suit individual preferences.

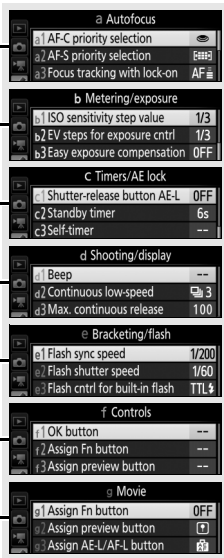
Main menu



Reset custom settings (326)






Custom Setting groups




Custom Settings


The following Custom Settings are available:

Custom Setting		
Reset custom settings		326
a Autofocus		
a1	AF-C priority selection	326
a2	AF-S priority selection	327
a3	Focus tracking with lock-on	328
a4	Focus point illumination	329
a5	AF point illumination	329
a6	Focus point wrap-around	330
a7	Number of focus points	330
a8	Store points by orientation	331
a9	Built-in AF-assist illuminator	332
b Metering/exposure		
b1	ISO sensitivity step value	333
b2	EV steps for exposure cntrl	333
b3	Easy exposure compensation	334
b4	Matrix metering	335
b5	Center-weighted area	335
b6	Fine-tune optimal exposure	336
c Timers/AE lock		
c1	Shutter-release button AE-L	336
c2	Standby timer	336
c3	Self-timer	337
c4	Monitor off delay	337
c5	Remote on duration (ML-L3)	337
d Shooting/display		
d1	Beep	338
d2	Continuous low-speed	338
d3	Max. continuous release	339
d4	Exposure delay mode	339
d5	Flash warning	339
d6	File number sequence	340
d7	Viewfinder grid display	341
d8	Easy ISO	341

Custom Setting		
d Shooting/display		
d9	Information display	341
d10	LCD illumination	342
d11	MB-D16 battery type	343
d12	Battery order	344
e Bracketing/flash		
e1	Flash sync speed	345
e2	Flash shutter speed	346
e3	Flash cntrl for built-in flash	347
e4	Exposure comp. for flash	353
e5	Modeling flash	353
e6	Auto bracketing set	353
e7	Bracketing order	354
f Controls		
f1	OK button	354
f2	Assign Fn button	356
f3	Assign preview button	361
f4	Assign AE-L/AF-L button	361
f5	Customize command dials	363
f6	Release button to use dial	365
f7	Slot empty release lock	365
f8	Reverse indicators	366
f9	Assign movie record button	366
f10	Assign MB-D16  button	367
f11	Assign remote (WR) Fn button	368
g Movie		
g1	Assign Fn button	370
g2	Assign preview button	372
g3	Assign AE-L/AF-L button	373
g4	Assign shutter button	373

Note: Depending on camera settings, some items may be grayed out and unavailable. If settings in the current bank have been modified from default values ( 295), an asterisk will be displayed adjacent to the altered settings in the second level of the Custom Settings menu.

Reset Custom Settings

MENU button →  Custom Settings menu



Select **Yes** to restore Custom Settings to their default values (📖 295).

a: Autofocus

a1: AF-C Priority Selection

MENU button →  Custom Settings menu


When **AF-C** is selected for viewfinder photography (📖 121), this option controls whether photographs can be taken whenever the shutter-release button is pressed (*release priority*) or only when the camera is in focus (*focus priority*).



Option	Description
 Release	Photos can be taken whenever the shutter-release button is pressed.
 Focus	Photos can only be taken when the in-focus indicator (●) is displayed.

Regardless of the option selected, focus will not lock when **AF-C** is selected for autofocus mode. The camera will continue to adjust focus until the shutter is released.

a2: AF-S Priority Selection


MENU button →  Custom Settings menu

When **AF-S** is selected for viewfinder photography ( 121), this option controls whether photographs can be taken only when the camera is in focus (*focus priority*) or whenever the shutter-release button is pressed (*release priority*).






Option	Description
 Release	Photos can be taken whenever the shutter-release button is pressed.
 Focus	Photos can only be taken when the in-focus indicator (●) is displayed.

Regardless of the option selected, if the in-focus indicator (●) is displayed when **AF-S** is selected for autofocus mode, focus will lock while the shutter-release button is pressed halfway. Focus lock continues until the shutter is released.

a3: Focus Tracking with Lock-On

MENU button →  Custom Settings menu





This option controls how autofocus adjusts to sudden large changes in the distance to the subject when **AF-C** is selected or continuous-servo autofocus is selected when the camera is in **AF-A** mode for viewfinder photography (📖 121).

Option	Description
AF  5 (Long)	When the distance to the subject changes abruptly, the camera waits for the specified period before adjusting the distance to the subject. This prevents the camera from refocusing when the subject is briefly obscured by objects passing through the frame. Note that 2 , 1 (Short) , and Off are equivalent to 3 (Normal) when 3D-tracking or auto-area AF is selected for AF-area mode.
AF  4	
AF  3 (Normal)	
AF  2	
AF  1 (Short)	
Off	The camera immediately adjusts focus when the distance to the subject changes. Use when photographing a series of subjects at varying distances in quick succession.

a4: Focus Point Illumination

MENU button →  Custom Settings menu

Choose from the following focus point display options.

Option	Description		
Manual focus mode	Choose On to display the active focus point in manual focus mode, Off to display the focus point only during focus point selection.		
Dynamic-area AF display	Choose On to display both the selected focus point and the surrounding focus points in dynamic-area AF mode (☐ 123). When 3D-tracking is used, a dot will be displayed in the center of the focus point (☐). Select Off to display only the selected focus point.		
Group-area AF illumination	Choose how the active focus points are displayed in group-area AF (☐ 124).	Option	Focus point display
			
			


a5: AF Point Illumination

MENU button →  Custom Settings menu


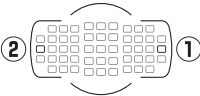

Choose whether the active focus point is highlighted in red in the viewfinder.

Option	Description
Auto	The selected focus point is automatically highlighted as needed to establish contrast with the background.
On	The selected focus point is always highlighted, regardless of the brightness of the background. Depending on the brightness of the background, the selected focus point may be difficult to see.
Off	The selected focus point is not highlighted.

a6: Focus Point Wrap-Around

MENU button →  Custom Settings menu



Choose whether focus-point selection “wraps around” from one edge of the viewfinder to another.

Option	Description
Wrap	Focus-point selection “wraps around” from top to bottom, bottom to top, right to left, and left to right, so that, for example, pressing  when a focus point at the right edge of the display is highlighted (①) selects the corresponding focus point at the left edge of the display (②). 
No wrap	The focus-point display is bounded by the outermost focus points so that, for example, pressing  when a focus point at the right edge of the display is selected has no effect.

a7: Number of Focus Points

MENU button →  Custom Settings menu

Choose the number of focus points available for manual focus-point selection.

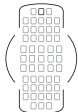
Option	Description
AF51 51 points	Choose from the 51 focus points shown at right. 
AF11 11 points	Choose from the 11 focus points shown at right. Use for quick focus-point selection. 

a8: Store Points by Orientation

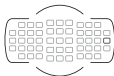
MENU button →  Custom Settings menu

Choose whether separate focus points can be selected for “wide” (landscape) orientation, for “tall” (portrait) orientation with the camera rotated 90° clockwise, and for “tall” orientation with the camera rotated 90° counterclockwise.

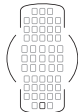
Select **No** to use the same focus point regardless of camera orientation.



*Camera rotated 90°
counter-clockwise*

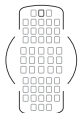


*Landscape (wide)
orientation*



*Camera rotated 90°
clockwise*

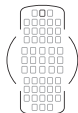
Choose **Yes** to enable separate focus-point selection.



*Camera rotated 90°
counter-clockwise*




*Landscape (wide)
orientation*

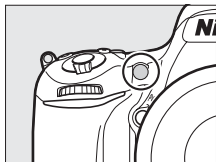


*Camera rotated 90°
clockwise*

a9: Built-in AF-assist Illuminator

MENU button →  Custom Settings menu

Choose whether the built-in AF-assist illuminator lights to assist the focus operation when lighting is poor.




Option	Description
On	The AF-assist illuminator lights when lighting is poor (viewfinder photography only). AF-assist illumination is only available when both of the following conditions are met: <ol style="list-style-type: none">1. AF-S is selected for autofocus mode (☐ 121) or single-servo autofocus is selected when the camera is in AF-A mode.2. Auto-area AF is chosen for AF-area mode (☐ 123), or an option other than auto-area AF is chosen and the center focus point is selected.
Off	The AF-assist illuminator does not light to assist the focus operation. The camera may not be able to focus using autofocus when lighting is poor.

The AF-Assist Illuminator

The AF-assist illuminator has a range of about 0.5–3.0 m (1 ft 8 in.–9 ft 10 in.); when using the illuminator, remove the lens hood.


b: Metering/Exposure

b1: ISO Sensitivity Step Value

MENU button →  Custom Settings menu


Select the increments used when making adjustments to ISO sensitivity (📖 134). If possible, the current ISO sensitivity setting is maintained when the step value is changed. If the current setting is not available at the new step value, ISO sensitivity will be rounded to the nearest available setting.


b2: EV Steps for Exposure Cntrl



MENU button →  Custom Settings menu

Select the increments used when making adjustments to shutter speed, aperture, exposure and flash compensation, and bracketing.

b3: Easy Exposure Compensation

MENU button →  Custom Settings menu

This option controls whether the  button is needed to set exposure compensation (📖 143). If **On (Auto reset)** or **On** is selected, the 0 at the center of the exposure display will flash even when exposure compensation is set to ± 0 .


Option	Description
On (Auto reset)	Exposure compensation is set by rotating one of the command dials (see note below). The setting selected using the command dial is reset when the camera turns off or the standby timer expires (exposure compensation settings selected using the  button are not reset).
On	As above, except that the exposure compensation value selected using the command dial is not reset when the camera turns off or the standby timer expires.
Off	Exposure compensation is set by pressing the  button and rotating the main command dial.

Change Main/Sub

The dial used to set exposure compensation when **On (Auto reset)** or **On** is selected for Custom Setting b3 (**Easy exposure compensation**) depends on the option selected for Custom Setting f5 (**Customize command dials**) > **Change main/sub** (📖 363).



		Customize command dials > Change main/sub	
		Off	On
Mode	P	Sub-command dial	Sub-command dial
	S	Sub-command dial	Main command dial
	A	Main command dial	Sub-command dial
	M	N/A	

Easy ISO


Custom Setting b3 (**Easy exposure compensation**) can not be used with Custom Setting d8 (**Easy ISO**,  341). Adjustments to either of these items reset the remaining item; a message is displayed when the item is reset.

b4: Matrix Metering


MENU button →  Custom Settings menu

Choose  **Face detection on** to enable face detection when shooting portraits with matrix metering during viewfinder photography ( 139).


b5: Center-Weighted Area

MENU button →  Custom Settings menu

When calculating exposure, center-weighted metering assigns the greatest weight to a circle in the center of the frame. The diameter (ϕ) of this circle can be set to 8, 12, 15, or 20 mm or to the average of the entire frame.



Note that when a non-CPU lens is used, the area assigned the greatest weight for center-weighted metering is equivalent to a circle with a diameter of 12 mm, regardless of the setting selected for **Non-CPU lens data** in the setup menu ( 235).

b6: Fine-tune Optimal Exposure

MENU button →  Custom Settings menu


Use this option to fine-tune the exposure value selected by the camera. Exposure can be fine-tuned separately for each metering method by from +1 to -1 EV in steps of 1/6 EV.

Fine-Tuning Exposure

Exposure fine-tuning is not affected by two-button resets. Note that as the exposure compensation () icon is not displayed, the only way to determine how much exposure has been altered is to view the amount in the fine-tuning menu. Exposure compensation ( 143) is preferred in most situations.


c: Timers/AE Lock

c1: Shutter-Release Button AE-L

MENU button →  Custom Settings menu

If **On** is selected, exposure will lock when the shutter-release button is pressed halfway.

c2: Standby timer

MENU button →  Custom Settings menu



Choose how long the camera continues to meter exposure when no operations are performed. The shutter-speed and aperture displays in the control panel and viewfinder turn off automatically when the standby timer expires.

Choose a shorter standby timer delay for longer battery life.

c3: Self-Timer

MENU button →  Custom Settings menu

Choose the length of the shutter release delay, the number of shots taken, and the interval between shots in self-timer mode (📖 106).

- **Self-timer delay:** Choose the length of the shutter-release delay.
- **Number of shots:** Press  and  to choose the number of shots taken each time the shutter-release button is pressed.
- **Interval between shots:** Choose the interval between shots when the **Number of shots** is more than 1.

c4: Monitor off Delay

MENU button →  Custom Settings menu

Choose how long the monitor remains on when no operations are performed during playback (**Playback**; defaults to 10 s) and image review (**Image review**; defaults to 4 s), when menus (**Menus**; defaults to 1 minute) or information (**Information display**; defaults to 10 s) are displayed, or during live view and movie recording (**Live view**; defaults to 10 minutes). Choose a shorter monitor-off delay for longer battery life.


c5: Remote on Duration (ML-L3)






MENU button →  Custom Settings menu


Choose how long the camera will remain on stand-by in remote release mode (📖 193). If no operations are performed for the selected period, remote shooting will end and **Off** will automatically be selected for **Remote control mode (ML-L3)** in the photo shooting menu. Choose shorter times for longer battery life.

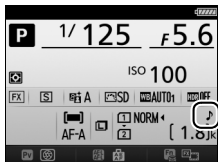
d: Shooting/Display

d1: Beep



MENU button →  Custom Settings menu

Choose the pitch and volume of the beep that sounds when the camera focuses using single-servo AF (**AF-S** or when single-servo AF is selected for **AF-A**;  121), when focus locks during live view photography, while the release timer is counting down in self-timer and delayed remote release modes ( 193), when a photograph is taken in quick-response remote or remote mirror-up mode ( 193), when time-lapse photography ends ( 229), or if you attempt to take a photograph when the memory card is locked ( 33).


- **Volume:** Choose **3** (high), **2** (medium), **1** (low) or **Off** (mute). When an option other than **Off** is selected,  appears in the information display.
- **Pitch:** Choose **High** or **Low**.




Beep

Note that regardless of the option selected, a beep will not sound when the camera focuses in movie live view ( 66) or quiet-shutter release modes (modes **Q** and **Qc**;  103).

d2: Continuous Low-Speed

MENU button →  Custom Settings menu


Choose the maximum frame advance rate in **CL** (continuous low speed) mode ( 103).

d3: Max. Continuous Release


MENU button →  Custom Settings menu

The maximum number of shots that can be taken in a single burst in continuous mode can be set to any value between 1 and 100. Note that this setting has no effect at shutter speeds of 4 s or slower.

The Memory Buffer


Regardless of the option selected for Custom Setting d3, shooting will slow when the memory buffer fills (). See page 492 for more information on the capacity of the memory buffer.


d4: Exposure Delay Mode

MENU button →  Custom Settings menu


In situations where the slightest camera movement can blur pictures, select **1 s**, **2 s**, or **3 s** to delay shutter release until one, two, or three seconds after the mirror is raised.

d5: Flash Warning

MENU button →  Custom Settings menu

If **On** is selected, the flash-ready indicator () will flash in the viewfinder if the flash is required to ensure optimal exposure.

d6: File Number Sequence

MENU button →  Custom Settings menu

When a photograph is taken, the camera names the file by adding one to the last file number used. This option controls whether file numbering continues from the last number used when a new folder is created, the memory card is formatted, or a new memory card is inserted in the camera.

Option	Description
On	When a new folder is created, the memory card formatted, or a new memory card inserted in the camera, file numbering continues from the last number used or from the largest file number in the current folder, whichever is higher. If a photograph is taken when the current folder contains a photograph numbered 9999, a new folder will be created automatically and file numbering will begin again from 0001.
Off	File numbering is reset to 0001 when a new folder is created, the memory card is formatted, or a new memory card is inserted in the camera. Note that a new folder is created automatically if a photograph is taken when the current folder contains 999 photographs.
Reset	As for On , except that the next photograph taken is assigned a file number by adding one to the largest file number in the current folder. If the folder is empty, file numbering is reset to 0001.

File Number Sequence

If the current folder is numbered 999 and contains either 999 photographs or a photograph numbered 9999, the shutter-release button will be disabled and no further photographs can be taken. Choose **Reset** for Custom Setting d6 (**File number sequence**) and then either format the current memory card or insert a new memory card.


d7: Viewfinder Grid Display

MENU button →  Custom Settings menu


Choose **On** to display on-demand grid lines in the viewfinder for reference when composing photographs (📖 10).

d8: Easy ISO

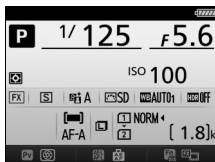
MENU button →  Custom Settings menu

If **On** is selected, ISO sensitivity can be set in modes **P** and **S** by rotating the sub-command dial or in mode **A** by rotating the main command dial. Select **Off** to set ISO sensitivity by pressing the  (**ISO**) button and rotating the main command dial.

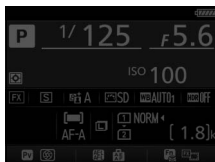
d9: Information Display

MENU button →  Custom Settings menu

If **Auto (AUTO)** is selected, the color of the lettering in the information display (📖 12) will automatically change from black to white or white to black to maintain contrast with the background. To always use the same color lettering, select **Manual** and choose **Dark on light (B; black lettering)** or **Light on dark (W; white lettering)**.






Dark on light




Light on dark

d10: LCD Illumination




MENU button →  Custom Settings menu

If **Off** is selected, the control panel backlight (LCD illuminator) will only light while the power switch is rotated toward . If **On** is selected, the control panel will be illuminated whenever the standby timer is active ( 39). Select **Off** for increased battery life.

d11: MB-D16 Battery Type






MENU button →  Custom Settings menu

To ensure that the camera functions as expected when the optional MB-D16 battery pack is used with AA batteries, match the option selected in this menu to the type of batteries inserted in the battery pack. There is no need to adjust this option when using EN-EL15 batteries.


Option	Description
 LR6 (AA alkaline)	Select when using LR6 alkaline AA batteries.
 Ni-MH HR6 (AA Ni-MH)	Select when using HR6 Ni-MH AA batteries.
 FR6 (AA lithium)	Select when using FR6 lithium AA batteries.

Using AA Batteries

The capacity of AA batteries drops sharply at temperatures below 20 °C (68 °F) and varies with make and storage conditions; in some cases, batteries may cease to function before their expiry date. Some AA batteries can not be used; due to their performance characteristics and limited capacity, alkaline batteries have less capacity than some other types and should only be used if no alternative is available and then only at warmer temperatures. The camera shows the level of AA batteries as follows:

Control panel	Viewfinder	Description
	—	Batteries fully charged.
		Low battery. Ready fresh batteries.
 (flashes)	 (flashes)	Shutter release disabled. Change batteries.

d12: Battery Order





MENU button →  Custom Settings menu

Choose whether the battery in the camera or the batteries in the battery pack are used first when an optional MB-D16 battery pack is attached. Note that if the MB-D16 is powered by an optional AC adapter and power connector, the AC adapter will be used regardless of the option selected.

The MB-D16 Battery Pack

The MB-D16 takes one EN-EL15 rechargeable Li-ion battery or six AA alkaline, Ni-MH, or lithium batteries (an EN-EL15 is supplied with the camera; AA batteries are available separately).


The information display shows the type of battery inserted in the MB-D16 as follows:

MB-D16 battery type display	Battery type
	EN-EL15 rechargeable Li-ion battery
	LR6 alkaline AA batteries
	HR6 Ni-MH AA batteries
	FR6 lithium AA batteries



e: Bracketing/Flash

e1: Flash Sync Speed

MENU button →  Custom Settings menu

This option controls flash sync speed.

Option	Description
1/250 s (Auto FP)	Auto FP high-speed sync is used when a compatible flash unit is attached (□ 435). If the built-in flash or other flash units are used, shutter speed is set to $\frac{1}{250}$ s. When the camera shows a shutter speed of $\frac{1}{250}$ s in mode P or A , auto FP high-speed sync will be activated if the actual shutter speed is faster than $\frac{1}{250}$ s.
1/200 s (Auto FP)	Auto FP high-speed sync is used when a compatible flash unit is attached (□ 435). If the built-in flash or other flash units are used, shutter speed is set to $\frac{1}{200}$ s. When the camera shows a shutter speed of $\frac{1}{200}$ s in mode P or A , auto FP high-speed sync will be activated if the actual shutter speed is faster than $\frac{1}{200}$ s.
1/200 s–1/60 s	Flash sync speed set to selected value.



Fixing Shutter Speed at the Flash Sync Speed Limit

To fix shutter speed at the sync speed limit in mode **S** or **M**, select the next shutter speed after the slowest possible shutter speed (30 s or - -). An X (flash sync indicator) will be displayed in the viewfinder and control panel.

Auto FP High-Speed Sync

Allows the flash to be used at the highest shutter speed supported by the camera, making it possible to choose the maximum aperture for reduced depth of field even when the subject is backlit in bright sunlight. The information display flash mode indicator shows “FP” when auto FP high-speed sync is active (□ 440).


■ Auto FP High-Speed Sync

When **1/250 s (Auto FP)** or **1/200 s (Auto FP)** is selected for Custom Setting e1 (**Flash sync speed**,  345), the built-in flash can be used at shutter speeds as fast as $\frac{1}{250}$ s or $\frac{1}{200}$ s, while compatible optional flash units ( 435) can be used at any shutter speed (Auto FP High-Speed Sync).

Flash sync speed \ Shutter speed	1/250 s (Auto FP)		1/200 s (Auto FP)		1/200 s	
	Built-in flash	Optional flash unit	Built-in flash	Optional flash unit	Built-in flash	Optional flash unit
From $\frac{1}{4000}$ to but not including $\frac{1}{250}$ s	—	Auto FP	—	Auto FP	—	—
From $\frac{1}{250}$ to but not including $\frac{1}{200}$ s	Flash sync*		—	Auto FP	—	—
$\frac{1}{200}$ –30 s	Flash sync					

* Flash range drops as shutter speed increases. Flash range will nevertheless be greater than that obtained at the same speeds with Auto FP.

e2: Flash Shutter Speed





MENU button →  Custom Settings menu

This option determines the slowest shutter speed available when using front- or rear-curtain sync or red-eye reduction in mode **P** or **A** (regardless of the setting chosen, shutter speeds can be as slow as 30 s in **S** and **M** modes or at flash settings of slow sync, slow rear-curtain sync, or red-eye reduction with slow sync).

e3: Flash Cntrl for Built-in Flash

MENU button →  Custom Settings menu





Choose the flash mode for the built-in flash.

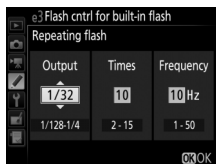
Option	Description
TTL  TTL	Flash output is adjusted automatically in response to shooting conditions.
 Manual	Choose the flash level (□ 347). The camera does not emit monitor pre-flashes.
RPT  Repeating flash	The flash fires repeatedly while the shutter is open, producing a strobe-light effect (□ 347).
CMD  Commander mode	Use the built-in flash as a master flash controlling remote optional flash units in one or more groups (□ 348).

Manual

Choose a flash level. Flash level is stated in fractions of full power: at full power, the built-in flash has a Guide Number of 12/39 (m/ft, ISO 100, 20°C/68°F).

Repeating Flash

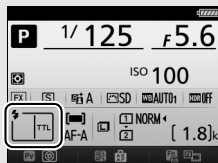
The flash fires repeatedly while the shutter is open, producing a strobe-light effect. Press  or  to highlight the following options,  or  to change.



Option	Description
Output	Choose flash output (expressed as a fraction of full power).
Times	Choose the number of times the flash fires at the selected output. Note that depending on shutter speed and the option selected for Frequency , the actual number of flashes may be less than selected.
Frequency	Choose how often the flash fires per second.

Flash Control Mode

The flash control mode for the built-in flash is shown in the information display (☞ 185).



"Manual" and "Repeating Flash"

Icons flash in the control panel and viewfinder when these options are selected.

The SB-500, SB-400, and SB-300

When an optional SB-500, SB-400, or SB-300 flash unit is attached and turned on, Custom Setting e3 changes to **Optional flash**, allowing the flash control mode for the optional flash unit to be selected from **TTL** and **Manual** (the SB-500 also offers a **Commander mode** option).

"Times"

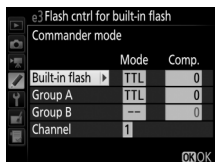
The options available for **Repeating Flash > Times** are determined by flash output.

Output	Options available for "Times"	Output	Options available for "Times"
1/4	2	1/32	2–10, 15
1/8	2–5	1/64	2–10, 15, 20, 25
1/16	2–10	1/128	2–10, 15, 20, 25, 30, 35

Commander Mode

Use the built-in flash as a master flash controlling one or more remote optional flash units in up to two groups (A and B) using advanced wireless lighting (☞ 435).

Selecting this option displays the menu shown at right. Press \leftarrow or \rightarrow to highlight the following options, \uparrow or \downarrow to change.

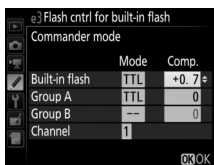


Option	Description
Built-in flash	Choose a flash mode for the built-in flash (commander flash). When an optional SB-500 flash unit is attached, this option changes to Optional flash and is used to choose a flash mode for the SB-500. Otherwise this option is identical to Built-in flash .
TTL	i-TTL mode. Choose flash compensation from values between +3.0 and -3.0 EV in increments of 1/3 EV.
M	Choose the flash level.
--	The built-in flash does not fire, although remote flash units do. The built-in flash must be raised so that it can emit monitor pre-flashes.
Group A	Choose a flash mode for all flash units in group A.
TTL	i-TTL mode. Choose flash compensation from values between +3.0 and -3.0 EV in increments of 1/3 EV.
AA	Auto aperture (available only with compatible flash units; □ 435). Choose flash compensation from values between +3.0 and -3.0 EV in increments of 1/3 EV.
M	Choose the flash level.
--	The flash units in this group do not fire.
Group B	Choose a flash mode for all flash units in group B. The options available are the same as those listed for Group A , above.
Channel	Choose from channels 1-4. All flash units in both groups must be set to the same channel.

Follow the steps below to take photographs in commander mode.

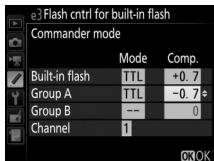
1 Adjust settings for the built-in flash.

Choose the flash control mode and output level for the built-in flash. Note that output level can not be adjusted in -- mode.



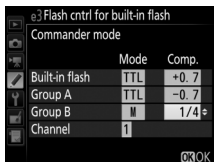
2 Adjust settings for group A.

Choose the flash control mode and output level for the flash units in group A.

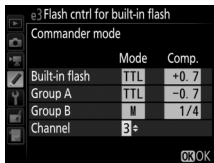


3 Adjust settings for group B.

Choose the flash control mode and output level for the flash units in group B.



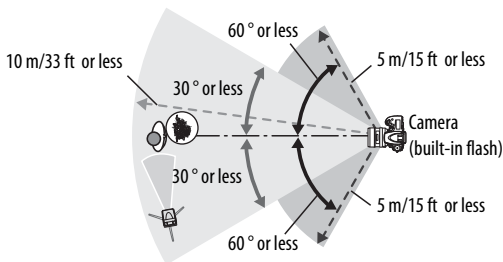
4 Select the channel.



5 Press **OK**.

6 Compose the shot.

Compose the shot and arrange the flash units as shown below. Note that the maximum distance at which the remote flash units can be placed may vary with shooting conditions.




Wireless remote sensors on flash units should face camera.

7 Configure the remote flash units.

Turn all the remote flash units on, adjust group settings as desired, and set them to the channel selected in Step 4. See the flash unit instruction manuals for details.

8 Raise the built-in flash.

Press the  button to raise the built-in flash. Note that even if -- is selected for **Built-in flash > Mode**, the built-in flash must be raised so that monitor preflashes will be emitted.

9 Frame the photograph, focus, and shoot.

After confirming that the camera flash-ready light and the flash-ready lights for all other flash units are lit, frame the photograph, focus, and shoot. FV lock (📖 190) can be used if desired.

🔍 The Flash Sync Mode Display

⚡ does not appear in the information display when -- is selected for **Built-in flash > Mode**.

🔍 Flash Compensation

The flash compensation value selected with the ⚡ (🔍) button and sub-command dial is added to the flash compensation values selected for the built-in flash, group A, and group B in the **Commander mode** menu. A 🔍 icon is displayed in the control panel and viewfinder when a flash compensation value other than ± 0 is selected for the built-in flash or remote flash units in TTL or AA mode. The 🔍 icon flashes when the built-in flash is in mode **M**.

🔍 Commander Mode



Position the sensor windows on the remote flash units to pick up the light from the built-in flash (particular care is required if the camera is not mounted on a tripod). Be sure that direct light or strong reflections from the remote flash units do not enter the camera lens (in TTL mode) or the photocells on the remote flash units (AA mode), as this may interfere with exposure. To prevent timing flashes emitted by the built-in flash from appearing in photographs taken at short range, choose low ISO sensitivities or small apertures (high f-numbers) or use an optional SG-3IR infrared panel for the built-in flash. An SG-3IR is required for best results with rear-curtain sync, which produces brighter timing flashes. After positioning the remote flash units, take a test shot and view the results in the camera monitor.

Although there is no limit on the number of remote flash units that may be used, the practical maximum is three. With more than this number, the light emitted by the remote flash units will interfere with performance.

e4: Exposure Comp. for Flash

MENU button →  Custom Settings menu

Choose how the camera adjusts flash level when exposure compensation is used.

Option	Description
 Entire frame	Both flash level and exposure compensation are adjusted to modify exposure over the entire frame.
 Background only	Exposure compensation applies to background only.

e5: Modeling Flash

MENU button →  Custom Settings menu


If **On** is selected when the camera is being used with the built-in flash or an optional flash unit that supports the Nikon Creative Lighting system (📖 435), a modeling flash will be emitted when the camera **Pv** button is pressed (📖 92). No modeling flash is emitted if **Off** is selected.

e6: Auto Bracketing Set

MENU button →  Custom Settings menu

Choose the setting or settings bracketed when auto bracketing (📖 202) is in effect. Choose **AE & flash** (AE[Ⓝ]) to perform both exposure and flash-level bracketing, **AE only** (AE) to bracket only exposure, **Flash only** (Ⓝ) to perform only flash-level bracketing, **WB bracketing** (WB) to perform white-balance bracketing (📖 208), or **ADL bracketing** (ADL[Ⓝ]) to perform bracketing using Active D-Lighting (📖 212). Note that white balance bracketing is not available at image quality settings of NEF (RAW) or NEF (RAW) + JPEG.


e7: Bracketing Order



MENU button →  Custom Settings menu

At the default setting of **MTR > under > over** (N), exposure, flash, and white balance bracketing are performed in the order described on pages 204 and 209. If **Under > MTR > over** (->+) is selected, shooting will proceed in order from the lowest to the highest value. This setting has no effect on ADL bracketing.




f: Controls

f1: OK Button







MENU button →  Custom Settings menu

This option determines the role assigned to the  button during viewfinder photography, playback, and live view (regardless of the option selected, pressing  when a movie is displayed full frame starts movie playback).






■ Shooting Mode

Option	Role assigned to  button
RESET Select center focus point	Select the center focus point.
 Highlight active focus point	Highlight the active focus point.
None	Pressing the  button has no effect in viewfinder photography.


■ ■ Playback Mode

Option	Role assigned to  button
 Thumbnail on/off	Toggle between full-frame and thumbnail playback.
 View histograms	In both full-frame and thumbnail playback, a histogram is displayed while the  button is pressed (□ 250).
 Zoom on/off	Toggle between full-frame or thumbnail playback and playback zoom. Choose the initial zoom setting from Low magnification (50%) , 1 : 1 (100%) , and High magnification (200%) . The zoom display will center on the active focus point.
 Choose slot and folder	Display the slot and folder selection dialog (□ 245).

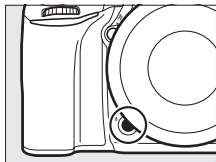
■ ■ Live View

Option	Role assigned to  button
RESET Select center focus point	Pressing the  button in live view selects the center focus point.
 Zoom on/off	Press the  button to toggle zoom on and off. Choose the initial zoom setting from Low magnification (50%) , 1 : 1 (100%) , and High magnification (200%) . The zoom display will center on the active focus point.
None	Pressing the  button has no effect in live view.

f2: Assign Fn Button









MENU button →  Custom Settings menu













Choose the role played by the **Fn** button, either by itself (**Press**) or when used in combination with the command dials (**Press + command dials**).







■ ■ Press

Selecting **Press** displays the following options:

Option	Description
 Preview	During viewfinder photography, you can preview depth of field while the Fn button is pressed (□ 92). During live view photography, you can press the button once to open the lens to maximum aperture, making it easier to check focus; pressing the button again restores aperture to its original value (□ 56).
 FV lock	Press the Fn button to lock flash value (built-in flash and compatible optional flash units only, □ 190, 435). Press again to cancel FV lock.
 AE/AF lock	Focus and exposure lock while the Fn button is pressed.
 AE lock only	Exposure locks while the Fn button is pressed.
 AE lock (Hold)	Exposure locks when the Fn button is pressed, and remains locked until the button is pressed a second time or the standby timer expires.
 AF lock only	Focus locks while the Fn button is pressed.
 AF-ON	Pressing the Fn button initiates autofocus. The shutter-release button can not be used to focus.
 Flash off	The flash will not fire in photos taken while the Fn button is pressed.

Option	Description
BKT  Bracketing burst	If the Fn button is pressed while exposure, flash, or ADL bracketing is active in single frame or quiet shutter-release mode, all shots in the current bracketing program will be taken each time the shutter-release button is pressed. If white balance bracketing is active or continuous release mode (mode Ch , CL or Qc) is selected, the camera will repeat the bracketing burst while the shutter-release button is held down.
+RAW  + NEF (RAW)	If image quality is set to JPEG fine , JPEG normal , or JPEG basic , +RAW will be displayed in the viewfinder and an NEF (RAW) copy will be recorded with the next picture taken after the Fn button is pressed (the original image quality setting will be restored when you remove your finger from the shutter-release button). To exit without recording an NEF (RAW) copy, press the Fn button again.
 Matrix metering	Matrix metering is activated while the Fn button is pressed.
 Center-weighted metering	Center-weighted metering is activated while the Fn button is pressed.
 Spot metering	Spot metering is activated while the Fn button is pressed.
 * Highlight-weighted metering	Highlight-weighted metering is activated while the Fn button is pressed.
 Viewfinder grid display	Press the Fn button to turn the framing grid display in the viewfinder on or off ( 10).
 Viewfinder virtual horizon	Press the Fn button to view a virtual horizon display in the viewfinder ( 359).
 MY MENU	Pressing the Fn button displays “MY MENU” ( 421).


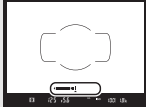
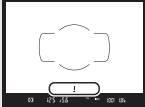
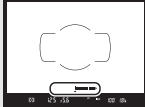

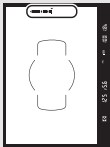
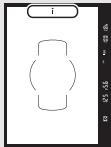
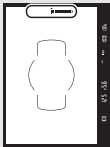
Option	Description
 Access top item in MY MENU	Press the Fn button to jump to the top item in “MY MENU.” Select this option for quick access to a frequently-used menu item.
 Playback	Fn button performs same function as  button. Select when using a telephoto lens or in other circumstances in which it is difficult to operate the  button with your left hand.
None	Pressing the button has no effect.

Incompatible Options

If the option selected for **Press** can not be used in combination with the option selected for **Press + command dials**, a message will be displayed and whichever of **Press** or **Press + command dials** was selected first will be set to **None**.

Viewfinder Virtual Horizon





When **Viewfinder virtual horizon** is selected for Custom Setting f2 (**Assign Fn button**) > **Press**, pressing the **Fn** button displays a roll indicator in the viewfinder. Press the button a second time to return to clear the indicators from display.

	Camera tilted right	Camera level	Camera tilted left
Viewfinder (camera in landscape orientation) 			
Viewfinder (camera in portrait orientation) 			

Note that the display may not be accurate when the camera is tilted at a sharp angle forward or back. For a display that shows both pitch and roll, use the **Virtual horizon** option in the setup menu (📖 388).

■ Press + Command Dials

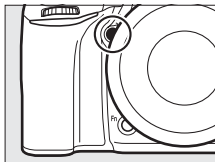
Selecting **Press + command dials** displays the following options:

Option	Description
 Choose image area	Keeping the Fn button pressed, rotate a command dial to choose an image area (□ 114).
 1 step spd/aperture	If the Fn button is pressed when the command dials are rotated, changes to shutter speed (modes S and M) and aperture (modes A and M) are made in increments of 1 EV, regardless of the option selected for Custom Setting b2 (EV steps for exposure cntrl , □ 333).
Non-CPU Choose non-CPU lens number	Press the Fn button and rotate a command dial to choose a lens number specified using the Non-CPU lens data option (□ 238).
 Active D-Lighting	Press the Fn button and rotate a command dial to adjust Active D-Lighting (□ 175).
HDR HDR (high dynamic range)	Keeping the Fn button pressed, rotate the main command dial to choose an HDR mode , the sub-command dial to choose HDR strength (□ 178).
 Exposure delay mode	Press the Fn button and rotate a command dial to choose an exposure delay mode (□ 339).
None	No operation is performed when the command dials are rotated while the Fn button is pressed.


f3: Assign Preview Button

MENU button →  Custom Settings menu

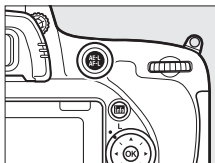
Choose the role played by the **Pv** button, either by itself (**Press**) or when used in combination with the command dials (**Press + command dials**). The options available are the same as for **Assign Fn button** (📖 356). The default options for **Press** and **Press + command dials** are **Preview** and **None**, respectively.



f4: Assign AE-L/AF-L Button




MENU button →  Custom Settings menu




Choose the role played by the AE-L/AF-L button, either by itself (**Press**) or when used in combination with the command dials (**Press + command dials**).



■ ■ Press


Selecting **Press** displays the following options:

Option	Description
 AE/AF lock	Focus and exposure lock while the AE-L/AF-L button is pressed.
 AE lock only	Exposure locks while the AE-L/AF-L button is pressed.
 AE lock (Hold)	Exposure locks when the AE-L/AF-L button is pressed, and remains locked until the button is pressed a second time or the standby timer expires.

Option	Description
 AF lock only	Focus locks while the ^{AE-L} / _{AF-L} AE-L/AF-L button is pressed.
 AF-ON	The ^{AE-L} / _{AF-L} AE-L/AF-L button initiates autofocus. The shutter-release button can not be used to focus.
 FV lock	Press the ^{AE-L} / _{AF-L} AE-L/AF-L button to lock flash value (built-in flash and compatible optional flash units only, □ 190, 435). Press again to cancel FV lock.
None	Pressing the button has no effect.

■ ■ Press + Command Dials



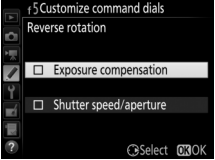
Selecting **Press + command dials** displays the following options:



Option	Description
 Choose image area	Keeping the ^{AE-L} / _{AF-L} AE-L/AF-L button pressed, rotate a command dial to choose an image area (□ 114).
Non-CPU Choose non-CPU lens number	Press the ^{AE-L} / _{AF-L} AE-L/AF-L button and rotate a command dial to choose a lens number specified using the Non-CPU lens data option (□ 238).
None	No operation is performed when the command dials are rotated while the ^{AE-L} / _{AF-L} AE-L/AF-L button is pressed.

f5: Customize Command Dials

MENU button →  Custom Settings menu

This option controls the operation of the main and sub-command dials.










Option	Description
Reverse rotation	<p>Reverse the direction of rotation of the command dials when they are used to make adjustments to Exposure compensation and/or Shutter speed/aperture. Highlight options and press  to select or deselect, then press .</p> <p>This setting also applies to the command dials for optional MB-D16 multi-power battery packs.</p> 
Change main/sub	<p>Exposure setting: If Off is selected, the main command dial controls shutter speed and the sub-command dial controls aperture. If On is selected, the main command dial will control aperture and the sub-command dial shutter speed. If On (Mode A) is selected, the main command dial will be used to set aperture in shooting mode A only.</p> <p>Autofocus setting: If On is selected, autofocus mode can be selected by keeping the AF-mode button pressed and rotating the sub-command dial, AF-area mode by keeping the AF-mode button pressed and rotating the main command dial.</p> <p>These settings also apply to the command dials for the MB-D16.</p>

Option	Description
Aperture setting	If Sub-command dial is selected, aperture can only be adjusted with the sub-command dial (or with the main command dial if On is selected for Change main/sub > Exposure setting). If Aperture ring is selected, aperture can only be adjusted with the lens aperture ring and the camera aperture display will show aperture in increments of 1 EV (aperture for type G and E lenses is still set using the sub-command dial). Note that regardless of the setting chosen, the aperture ring must be used to adjust aperture when a non-CPU lens is attached.
Menus and playback	If Off is selected, the multi selector is used to choose the picture displayed during full-frame playback, highlight thumbnails, and navigate menus. If On or On (image review excluded) is selected, the main command dial can be used to choose the picture displayed during full-frame playback, move the cursor left or right during thumbnail playback, and move the menu highlight bar up or down. The sub-command dial is used in full-frame playback to skip forward or back according to the option selected for Sub-dial frame advance and in thumbnail playback to page up or down. While menus are displayed, rotating the sub-command dial right displays the sub-menu for the selected option, while rotating it left displays the previous menu. To make a selection, press  or  . Select On (image review excluded) to prevent the command dials from being used for playback during image review.
Sub-dial frame advance	When On or On (image review excluded) is selected for Menus and playback , the sub-command dial can be rotated during full-frame playback to select a folder or to skip forward or back 10 or 50 frames at a time.

f6: Release Button to Use Dial

MENU button →  Custom Settings menu

Selecting **Yes** allows adjustments that are normally made by holding a button and rotating a command dial to be made by rotating the command dial after the button is released. Setting ends when the button is pressed again, the shutter-release button is pressed halfway, or the standby timer expires. This option is available with the following buttons:

Button		Button	
	143	 (REMOTE)	140
 (BKT)	180, 182	BKT	202
 (ISO)	134	Fn ¹	360
 (QUAL)	116, 118	Pv ²	361
 (WB)	146, 150, 154, 156, 159	 AE-L/AF-L ³	362
AF mode button	57, 59, 121, 125	Movie-record button ⁴	366


- 1 When assigned non-CPU lens number selection, Active D-Lighting, HDR, or exposure delay mode using Custom Setting f2.
- 2 When assigned non-CPU lens number selection, Active D-Lighting, HDR, or exposure delay mode using Custom Setting f3.
- 3 When assigned non-CPU lens number selection using Custom Setting f4.
- 4 When assigned white balance or ISO sensitivity using Custom Setting f9.



f7: Slot Empty Release Lock

MENU button →  Custom Settings menu

Selecting **Enable release** allows the shutter to be released when no memory card is inserted, although no pictures will be recorded (they will however be displayed in the monitor in demo mode). If **Release locked** is selected, the shutter-release button is only enabled when a memory card is inserted in the camera.

f8: Reverse Indicators

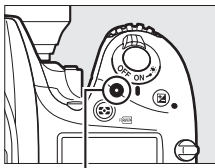
MENU button →  Custom Settings menu

If  (-0+) is selected, the exposure indicators in the control panel, viewfinder, and information display are displayed with negative values on the left and positive values on the right. Select  (+0-) to display positive values on the left and negative values on the right.

f9: Assign Movie Record Button


MENU button →  Custom Settings menu

Choose the role played by the movie-record button during viewfinder and live view photography.




Movie-record button

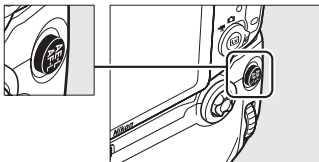
■ Press + Command Dials

















Option	Description
WB White balance	Press the button and rotate a command dial to choose a white balance option (□ 145).
ISO ISO sensitivity	Press the button and rotate a command dial to choose an ISO sensitivity (□ 134).
 Choose image area	Press the button and rotate a command dial to choose an image area (□ 114).
None	No operation is performed if the command dials are rotated while the button is pressed.

f10: Assign MB-D16 Button


MENU button →  Custom Settings menu

Choose the function assigned to the  **AE-L/AF-L** button on the optional MB-D16 battery pack.










Option	Description
 AE/AF lock	Focus and exposure lock while the MB-D16  AE-L/AF-L button is pressed.
 AE lock only	Exposure locks while the MB-D16  AE-L/AF-L button is pressed.
 AE lock (Hold)	Exposure locks when the MB-D16  AE-L/AF-L button is pressed, and remains locked until the button is pressed a second time or the standby timer expires.
 AF lock only	Focus locks while the MB-D16  AE-L/AF-L button is pressed.
 AF-ON	Pressing the MB-D16  AE-L/AF-L button initiates autofocus. The shutter-release button can not be used to focus.
 FV lock	Press the MB-D16  AE-L/AF-L button to lock flash value (built-in flash and compatible optional flash units only,  190, 435). Press again to cancel FV lock.
 Same as Fn button	The MB-D16  AE-L/AF-L button performs the same function as the camera Fn button ( 356).









f11: Assign Remote (WR) Fn Button

MENU button →  Custom Settings menu

Choose the role played by the **Fn** button on the wireless remote controller.



Option	Description
 Preview	During viewfinder photography, you can preview depth of field while the Fn button is pressed (□ 92). During live view photography, you can press the button once to open the lens to maximum aperture, making it easier to check focus; pressing the button again restores aperture to its original value (□ 56).
 FV lock	Press the Fn button to lock flash value (built-in flash and compatible optional flash units only, □ 190, 435). Press again to cancel FV lock.
 AE/AF lock	Focus and exposure lock while the Fn button is pressed.
 AE lock only	Exposure locks while the Fn button is pressed.
 AE lock (Hold)	Exposure locks when the Fn button is pressed, and remains locked until the button is pressed a second time or the standby timer expires.
 AF lock only	Focus locks while the Fn button is pressed.
 Flash off	The flash will not fire in photos taken while the Fn button is pressed.

Option	Description
+  + NEF (RAW)	If image quality is set to JPEG fine , JPEG normal , or JPEG basic , +  will be displayed in the viewfinder and an NEF (RAW) copy will be recorded with the next picture taken after the Fn button is pressed (the original image quality setting will be restored when you remove your finger from the shutter-release button). To exit without recording an NEF (RAW) copy, press the Fn button again.
 Live view	Pressing the Fn button starts and ends live view.
=  Same as camera Fn button	The wireless remote controller Fn button performs the same function as the camera Fn button (☞ 356).
=  Same as camera Pv button	The wireless remote controller Fn button performs the same function as the camera Pv button (☞ 361).
=  Same as camera  button	The wireless remote controller Fn button performs the same function as the camera  AE-L/AF-L button (☞ 361).
None	Pressing the button has no effect.









g: Movie

g1: Assign Fn Button


MENU button →  Custom Settings menu

Choose the role played by the **Fn** button during movie live view (the default option is **None**).


Press

Option	Description
 Power aperture (open)	Aperture widens while the button is pressed. Use in combination with Custom Setting g2 (Assign preview button) > Power aperture (close) for button-controlled aperture adjustment (□ 372).
 Index marking	Press the button during movie recording to add an index at the current position (□ 70). Indices can be used when viewing and editing movies.
 View photo shooting info	Press the button to display information on shutter speed, aperture, and other photo settings in place of movie recording information. Press again to return to the movie recording display.
 AE/AF lock	Focus and exposure lock while the button is pressed.
 AE lock only	Exposure locks while the button is pressed.
 AE lock (Hold)	Exposure locks when the button is pressed, and remains locked until the button is pressed a second time.
 AF lock only	Focus locks while the button is pressed.
 AF-ON	Pressing the button initiates autofocus. The shutter-release button can not be used to focus.
None	Pressing the button has no effect.

Power Aperture









Power aperture is not available with some lenses. Power aperture is available only in modes **A** and **M** and can not be used while photo shooting info is displayed (a  icon indicates that power aperture can not be used).

g2: Assign Preview Button

MENU button →  Custom Settings menu

Choose the role played by the **Pv** button during movie live view (the default option is **Index marking**).

Press

Option	Description
 Power aperture (close)	Aperture narrows while the button is pressed. Use in combination with Custom Setting g1 (Assign Fn button) > Power aperture (open) for button-controlled aperture adjustment (📖 370).
 Index marking	Press the button during movie recording to add an index at the current position (📖 70). Indices can be used when viewing and editing movies.
 View photo shooting info	Press the button to display information on shutter speed, aperture, and other photo settings in place of movie recording information. Press again to return to the movie recording display.
 AE/AF lock	Focus and exposure lock while the button is pressed.
 AE lock only	Exposure locks while the button is pressed.
 AE lock (Hold)	Exposure locks when the button is pressed, and remains locked until the button is pressed a second time.
 AF lock only	Focus locks while the button is pressed.
 AF-ON	Pressing the button initiates autofocus. The shutter-release button can not be used to focus.
None	Pressing the button has no effect.

g3: Assign AE-L/AF-L Button


MENU button →  Custom Settings menu




■ ■ Press

Choose the role played by the ^{AE-L}_{AF-L} AE-L/AF-L button during movie live view. The options available are the same as for **Assign Fn button** (□ 370), except that **Power aperture (open)** is not available and the default setting is **AE/AF lock**.

g4: Assign Shutter Button

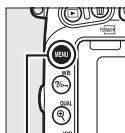
MENU button →  Custom Settings menu

Choose the role played by pressing the shutter-release button when  is selected with the live view selector.

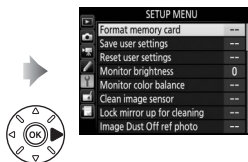
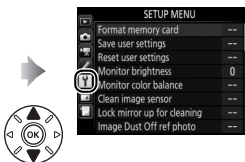
Option	Description
 Take photos	Press the shutter-release button all the way down to end movie recording and take a photograph with an aspect ratio of 16 : 9 (for information on image size, see page 77).
 Record movies	Press the shutter-release button halfway to start movie live view. You can then press the shutter-release button halfway to focus (autofocus mode only) and press it all the way down to start or end recording. The shutter-release button can not be used for other purposes during movie live view. To end movie live view, press the  button. The shutter-release button on an optional wireless remote controller or remote cord (□ 443, 444) functions in the same way as the camera shutter-release button; the optional ML-L3 remote control, however, can not be used to record movies; the shutter-release button on the ML-L3 has no effect.

Y The Setup Menu: Camera Setup

To display the setup menu, press **MENU** and select the **Y** (setup menu) tab.



MENU button



Setup Menu Options

The setup menu contains the following options:

Option	📖	Option	📖
Format memory card	375	Image comment	384
Save user settings	99	Copyright information	385
Reset user settings	101	Save/load settings	386
Monitor brightness	376	Virtual horizon	388
Monitor color balance	377	Non-CPU lens data	235
Clean image sensor	448	AF fine-tune	389
Lock mirror up for cleaning ¹	451	HDMI	278
Image Dust Off ref photo	378	Location data	239
Flicker reduction	380	Wi-Fi	282
Time zone and date	381	Network	269
Language	381	Eye-Fi upload ²	391
Auto image rotation	382	Conformity marking	392
Battery info	383	Firmware version	392

1 Not available when battery is low.

2 Only displayed when compatible Eye-Fi memory card is inserted.

🔗 See Also

Menu defaults are listed on page 299.

Format Memory Card

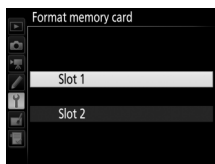
MENU button → Y setup menu

Memory cards must be formatted before first use or after being used or formatted in other devices. *Note that formatting permanently deletes all pictures and other data on the card.* Before formatting, be sure to make backup copies as required (📖 266).

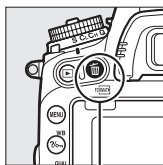
✔ During Formatting

Do not turn the camera off or remove memory cards during formatting.

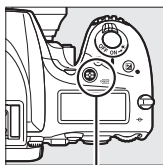
Selecting **Format memory card** in the setup menu displays the options shown at right; choose a memory card slot and select **Yes** to format the selected card.



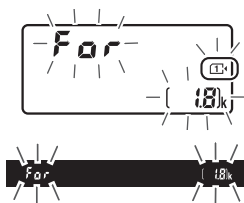
Memory cards can also be formatted by holding the (FORMAT) and (FORMAT) buttons down simultaneously until a flashing **F_{or}** appears in the shutter-speed displays in the control panel and viewfinder.



(FORMAT) button





(FORMAT) button






Press the buttons together again a second time to format the card (to exit without formatting the card, press any other button or wait for about six seconds until **F** **o** **r** stops flashing). When formatting is complete, the control panel and viewfinder will show the number of photographs that can be recorded at current settings.

Two Memory Cards

If two memory cards are inserted when the  (**FORMAT**) and  (**FORMAT**) buttons are pressed, the card to be formatted will be shown by a flashing icon. Rotate the main command dial to choose a different slot.

Monitor Brightness

MENU button →  *setup menu*

Press  or  to choose monitor brightness for playback, menus, and the information display. Choose higher values for increased brightness, lower values for reduced brightness.

Monitor Brightness



Values of **+4** or higher make the monitor easier to read in bright light but also result in yellow colors taking on a greenish cast. Choose lower values for accurate color reproduction.


See Also

The option selected for **Monitor brightness** has no effect on the brightness of the display during live view photography or movie live view. For information on adjusting monitor brightness in live view, see page 62.

Monitor Color Balance

MENU button → Y setup menu

Use the multi selector as shown below to adjust monitor color balance with reference to a sample image. The sample image is the last photograph taken or, in playback mode, the last photograph displayed; to choose a different image, press the  (ISO) button and select an image from a thumbnail list (to view the highlighted image full frame, press and hold ). If the memory card contains no photographs, an empty frame with a gray border will be displayed in place of the sample image.

Press  to exit when adjustments are complete. Monitor color balance applies only to menus, playback, and the view through the lens displayed during live view photography and movie live view; pictures taken with the camera are not affected.

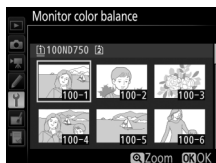
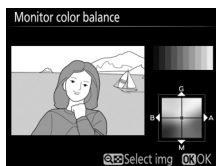


Image Dust Off Ref Photo

MENU button → Y setup menu

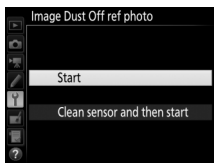
Acquire reference data for the Image Dust Off option in Capture NX-D (available for download, □ 268; for more information, refer to Capture NX-D on-line help).

Image Dust Off ref photo is available only when a CPU lens is mounted on the camera. A non-DX lens with a focal length of at least 50 mm is recommended. When using a zoom lens, zoom all the way in.

1 Choose a start option.

Highlight one of the following options and press **OK**. To exit without acquiring image dust off data, press **MENU**.

- **Start:** The message shown at right will be displayed and “rEF” will appear in the viewfinder and control panel displays.
- **Clean sensor and then start:** Select this option to clean the image sensor before starting. The message shown at right will be displayed and “rEF” will appear in the viewfinder and control panel displays when cleaning is complete.



2 Frame a featureless white object in the viewfinder.

With the lens about ten centimeters (four inches) from a well-lit, featureless white object, frame the object so that it fills the viewfinder and then press the shutter-release button halfway.

In autofocus mode, focus will automatically be set to infinity; in manual focus mode, set focus to infinity manually.

3 Acquire dust off reference data.

Press the shutter-release button the rest of the way down to acquire Image Dust Off reference data. The monitor turns off when the shutter-release button is pressed.

If the reference object is too bright or too dark, the camera may be unable to acquire Image Dust Off reference data and the message shown at right will be displayed. Choose another reference object and repeat the process from step 1.

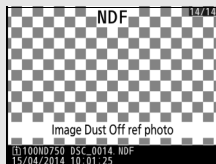


✔ Image Sensor Cleaning


Dust off reference data recorded before image sensor cleaning is performed can not be used with photographs taken after image sensor cleaning is performed. Select **Clean sensor and then start** only if the dust off reference data will not be used with existing photographs.

✔ Image Dust Off Reference Data

The same reference data can be used for photographs taken with different lenses or at different apertures. Reference images can not be viewed using computer imaging software. A grid pattern is displayed when reference images are viewed on the camera.



Flicker Reduction


MENU button →  setup menu

Reduce flicker and banding when shooting under fluorescent or mercury-vapor lighting during live view or movie recording. Choose **Auto** to allow the camera to automatically choose the correct frequency, or manually match the frequency to that of the local AC power supply.


✔ Flicker Reduction

If **Auto** fails to produce the desired results and you are unsure as to the frequency of the local power supply, test both the 50 and 60 Hz options and choose the one that produces the best results. Flicker reduction may not produce the desired results if the subject is very bright, in which case you should try choosing a smaller aperture (higher f-number).

Time Zone and Date

MENU button →  setup menu

Change time zones, set the camera clock, choose the date display order, and turn daylight saving time on or off.

Option	Description
Time zone	Choose a time zone. The camera clock is automatically set to the time in the new time zone.
Date and time	Set the camera clock. If the clock is reset, a flashing  icon will appear in the information display.
Date format	Choose the order in which the day, month, and year are displayed.
Daylight saving time	Turn daylight saving time on or off. The camera clock will automatically be advanced or set back one hour. The default setting is Off .

Language

MENU button →  setup menu

Choose a language for camera menus and messages.

Auto Image Rotation

MENU button → Y setup menu

Photographs taken while **On** is selected contain information on camera orientation, allowing them to be rotated automatically during playback (📖 242) or when viewed in ViewNX 2 (supplied) or in Capture NX-D (available for download; 📖 268). The following orientations are recorded:



*Landscape (wide)
orientation*



*Camera rotated 90°
clockwise*




*Camera rotated 90°
counter-clockwise*

Camera orientation is not recorded when **Off** is selected. Choose this option when panning or taking photographs with the lens pointing up or down.

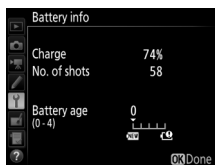
Rotate Tall

To automatically rotate “tall” (portrait-orientation) photographs for display during playback, select **On** for the **Rotate tall** option in the playback menu (📖 308).

Battery Info

MENU button →  setup menu

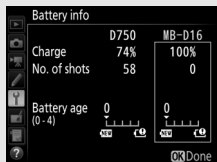
View information on the battery currently inserted in the camera.







Item	Description
Charge	The current battery level expressed as a percentage.
No. of shots	The number of times the shutter has been released with the current battery since the battery was last charged. Note that the camera may sometimes release the shutter without recording a photograph, for example when measuring preset manual white balance.
Battery age	A five-level display showing battery age. 0 (NEW) indicates that battery performance is unimpaired, 4 (⚡) that the battery has reached the end of its charging life and should be replaced. Note that fresh batteries charged at temperatures under about 5 °C (41 °F) may show a temporary drop in charging life; the battery age display will however return to normal once the battery has been recharged at a temperature of about 20 °C (68 °F) or higher.

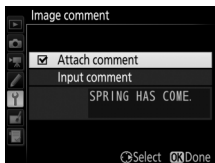
The MB-D16 Battery Pack



The display for the MB-D16 battery pack is shown at right. If AA batteries are used, the battery level will be shown by a battery level icon; other items will not be displayed.





Add a comment to new photographs as they are taken. Comments can be viewed as metadata in ViewNX 2 (supplied) or Capture NX-D (available for download;  268). The comment is also visible on the shooting data page in the photo information display ( 251). The following options are available:

- **Input comment:** Input a comment as described on page 171. Comments can be up to 36 characters long.
- **Attach comment:** Select this option to attach the comment to all subsequent photographs. **Attach comment** can be turned on and off by highlighting it and pressing . After choosing the desired setting, press  to exit.



Add copyright information to new photographs as they are taken. Copyright information is included in the shooting data shown in the photo information display ( 251) and can be viewed as metadata in ViewNX 2 (supplied) or in Capture NX-D (available for download;  268). The following options are available:


- **Artist:** Enter a photographer name as described on page 171. Photographer names can be up to 36 characters long.
- **Copyright:** Enter the name of the copyright holder as described on page 171. Copyright holder names can be up to 54 characters long.
- **Attach copyright information:** Select this option to attach copyright information to all subsequent photographs. **Attach copyright information** can be turned on and off by highlighting it and pressing . After choosing the desired setting, press  to exit.



Copyright Information

To prevent unauthorized use of the artist or copyright holder names, make sure that **Attach copyright information** is not selected and that the **Artist** and **Copyright** fields are blank before lending or transferring the camera to another person. Nikon does not accept liability for any damages or disputes arising from the use of the **Copyright information** option.

Save/Load Settings

MENU button →  setup menu

Select **Save settings** to save the following settings to the memory card in Slot 1 (📖 119; if the card is full, an error will be displayed). Use this option to share settings among D750 cameras.

Menu	Option
Playback	Playback display options
	Image review
	After delete
	Rotate tall
Photo shooting	File naming
	Role played by card in Slot 2
	Image quality
	Image size
	Image area
	JPEG compression
	NEF (RAW) recording
	White balance (with fine-tuning and presets d-1–d-6)
	Set Picture Control (Custom Picture Controls are saved as Standard)
	Color space
	Active D-Lighting
	Vignette control
	Auto distortion control
	Long exposure NR
	High ISO NR
ISO sensitivity settings	
Remote control mode (ML-L3)	
Movie shooting	Destination
	Frame size/frame rate
	Movie quality

Menu	Option
Movie shooting	Microphone sensitivity
	Frequency response
	Wind noise reduction
	Image area
	White balance (with fine-tuning and presets d-1–d-6)
	Set Picture Control (Custom Picture Controls are saved as Standard)
	High ISO NR
	Movie ISO sensitivity settings
Custom settings	All Custom Settings except Reset custom settings
Setup	Clean image sensor
	Flicker reduction
	Time zone and date (excepting date and time)
	Language
	Auto image rotation
	Image comment
	Copyright information
	Non-CPU lens data
	HDMI
	Location data
	Wi-Fi
	Eye-Fi upload
My Menu/ Recent Settings	All My Menu items
	All recent settings
	Choose tab

Settings saved using this model of camera can be restored by selecting **Load settings**. Note that **Save/load settings** is only available when a memory card is inserted in the camera, and that the **Load settings** option is only available if the card contains saved settings.

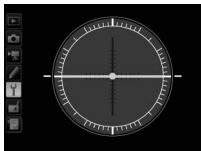
Saved Settings

Settings are saved in a file named NCSETUPG. The camera will not be able to load settings if the file name is changed.

Virtual Horizon

MENU button →  setup menu

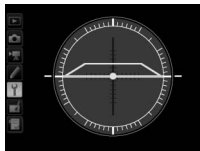
Display roll and pitch information based on information from the camera tilt sensor. If the camera is tilted neither left nor right, the roll reference line will turn green, while if the camera is tilted neither forward nor back, the dot in the center of the display will turn green. Each division is equivalent to about 5°.



Camera level



Camera tilted left or right




Camera tilted forward or back

Tilting the Camera

The virtual horizon display is not accurate when the camera is tilted at a sharp angle forward or back. If the camera is unable to measure tilt, the amount of tilt will not be displayed.



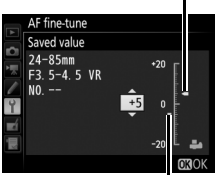
See Also






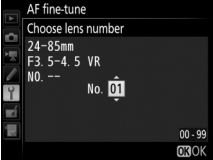
For information on viewing a roll indicator in the viewfinder, see Custom Setting f2 (**Assign Fn button > Press**;  356, 359). For information on displaying a virtual horizon in live view, see pages 64 and 75.

AF Fine-tune

MENU button → Y setup menu

Fine-tune focus for up to 12 lens types. AF tuning is not recommended in most situations and may interfere with normal focus; use only when required.


Option	Description
AF fine-tune (On/Off)	<ul style="list-style-type: none">• On: Turn AF tuning on.• Off: Turn AF tuning off.
Saved value	<p>Tune AF for the current lens (CPU lenses only). Press  or  to choose a value between +20 and -20. Values for up to 12 lens types can be stored. Only one value can be stored for each type of lens.</p> <p><i>Move focal point away from camera.</i> <i>Current value</i></p>  <p>↑</p> <p>↓</p>
Default	<p>Choose the AF tuning value used when no previously saved value exists for the current lens (CPU lenses only).</p> <p><i>Move focal point toward camera.</i> <i>Previous value</i></p>

Option	Description
<p>List saved values</p>	<p>List previously saved AF tuning values. To delete a lens from the list, highlight the desired lens and press  (FORMAT). To change a lens identifier (for example, to choose an identifier that is the same as the last two digits of the lens serial number to distinguish it from other lenses of the same type in light of the fact that Saved value can be used with only one lens of each type), highlight the desired lens and press .</p> <p>The menu shown at right will be displayed; press  or  to choose an identifier and press  to save changes and exit.</p> 

AF Tuning

The camera may be unable to focus at minimum range or at infinity when AF tuning is applied.

Live View

Tuning is not applied to autofocus during in live view ( 54).


Saved Value


Only one value can be stored for each type of lens. If a teleconverter is used, separate values can be stored for each combination of lens and teleconverter.

This option is displayed only when an Eye-Fi memory card (available separately from third-party suppliers) is inserted in the camera. Choose **Enable** to upload photographs to a preselected destination. Note that pictures will not be uploaded if signal strength is insufficient.

Observe all local laws concerning wireless devices and choose **Disable** where wireless devices are prohibited.







Eye-Fi Cards

Eye-Fi cards may emit wireless signals when **Disable** is selected. If a warning is displayed in the monitor ( 473), turn the camera off and remove the card.

Set Custom Setting c2 (**Standby timer**,  336) to 30 s or more when using an Eye-Fi card.

See the manual provided with the Eye-Fi card, and direct any inquiries to the manufacturer. The camera can be used to turn Eye-Fi cards on and off, but may not support other Eye-Fi functions.

When an Eye-Fi card is inserted, its status is indicated by an icon in the information display:

- : Eye-Fi upload disabled.
- : Eye-Fi upload enabled but no pictures available for upload.
-  (static): Eye-Fi upload enabled; waiting to begin upload.
-  (animated): Eye-Fi upload enabled; uploading data.
- : Error — camera can not control Eye-Fi card. If a flashing  appears in the control panel or viewfinder, refer to page 473; if this indicator is not flashing, pictures can be taken normally but you may be unable to change Eye-Fi settings.



Supported Eye-Fi Cards


Some cards may not be available in some countries or regions; consult the manufacturer for more information. Eye-Fi cards are for use only in the country of purchase. Be sure the Eye-Fi card firmware has been updated to the latest version. Note that using Eye-Fi cards in both slots is not recommended, as it may result in an unreliable network connection.

Conformity Marking

MENU button →  setup menu


View the standards with which the camera complies.

Firmware Version

MENU button →  setup menu

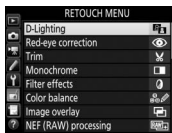
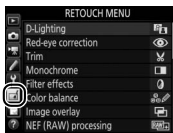
View the current camera firmware version.

The Retouch Menu: Creating Retouched Copies

To display the retouch menu, press **MENU** and select the  (retouch menu) tab.


























MENU button




Retouch Menu Options

The options in the retouch menu are used to create trimmed or retouched copies of existing pictures. The retouch menu is only displayed when a memory card containing photographs is inserted in the camera.

Option		Option	
 D-Lighting	397	 Straighten	411
 Red-eye correction	398	 Distortion control	412
 Trim	399	 Fisheye	413
 Monochrome	400	 Color outline	413
 Filter effects	401	 Color sketch	414
 Color balance	402	 Perspective control	415
 Image overlay ¹	403	 Miniature effect	416
 NEF (RAW) processing	406	 Selective color	417
 Resize	408	 Edit movie	81
 Quick retouch	411	 Side-by-side comparison ²	419

1 Can only be selected by pressing **MENU** and selecting  tab.

2 Available only if retouch menu is displayed by pressing  and selecting **Retouch** in full-frame playback when a retouched image or original is displayed.

✔ Retouching Copies

Most options can be applied to copies created using other retouch options, although with the exceptions of **Image overlay** and **Edit movie > Choose start/end point** each option can be applied only once (note that multiple edits may result in loss of detail). Options that can not be applied to the current image can not be selected.

✍ Image Quality

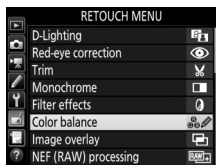
Except in the case of copies created with **Trim**, **Image overlay**, **NEF (RAW) processing**, and **Resize**, copies created from JPEG images are the same size and quality as the original, while copies created from NEF (RAW) photos are saved as large fine-quality JPEG images. Size-priority compression is used when copies are saved in JPEG format.

Creating Retouched Copies

To create a retouched copy:

1 Select an item in the retouch menu.

Press or to highlight an item, to select.



2 Select a picture.

Highlight a picture and press . To view the highlighted picture full screen, press and hold the (QUAL) button.



Retouch

In the case of images recorded at image quality settings of NEF + JPEG, only the NEF (RAW) image will be retouched. The camera may not be able to display or retouch images created with other devices.


3 Select retouch options.

For more information, see the section for the selected item. To exit without creating a retouched copy, press **MENU**.

Monitor off Delay


The monitor will turn off and the operation will be cancelled if no actions are performed for a brief period. Any unsaved changes will be lost. To increase the time the monitor remains on, choose a longer menu display time for Custom Setting c4 (**Monitor off delay**; 337).

4 Create a retouched copy.

Press **OK** to create a retouched copy. Retouched copies are indicated by a  icon.



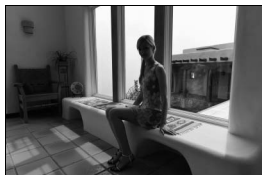
Creating Retouched Copies During Playback

To create a retouched copy of the picture currently displayed in full-frame playback ( 245), press **i**, then highlight **Retouch** and press **OK** and select a retouch option.

D-Lighting

MENU button →  retouch menu




D-Lighting brightens shadows, making it ideal for dark or backlit photographs.

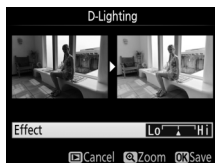


Before



After









Press  or  to choose the amount of correction performed. The effect can be previewed in the edit display. Press  to save the retouched copy.



Red-Eye Correction

MENU button →  retouch menu

This option is used to correct “red-eye” caused by the flash, and is available only with photographs taken using the flash. The photograph selected for red-eye correction can be previewed in the edit display. Confirm the effects of red-eye correction and create a copy as described in the following table. Note that red-eye correction may not always produce the expected results and may in very rare circumstances be applied to portions of the image that are not affected by red-eye; check the preview thoroughly before proceeding.








To	Use	Description
Zoom in	 (QUAL)	Press  (QUAL) to zoom in,  (ISO) to zoom out. While photo is zoomed in, use multi selector to view areas of image not visible in monitor. Keep multi selector pressed to scroll rapidly to other areas of frame. Navigation window is displayed when zoom buttons or multi selector is pressed; area currently visible in monitor is indicated by yellow border.
Zoom out	 (ISO)	
View other areas of image		
Cancel zoom		Press  to cancel zoom.
Create copy		If the camera detects red-eye in the selected photograph, a copy will be created that has been processed to reduce its effects. No copy will be created if the camera is unable to detect red-eye.

Trim

MENU button →  retouch menu

Create a cropped copy of the selected photograph. The selected photograph is displayed with the selected crop shown in yellow; create a cropped copy as described in the following table.



To	Use	Description
Reduce size of crop	 (ISO)	Press  (ISO) to reduce the size of the crop.
Increase size of crop	 (QUAL)	Press  (QUAL) to increase the size of the crop.
Change crop aspect ratio		Rotate the main command dial to choose the aspect ratio.
Position crop		Use multi selector to position the crop. Press and hold to move the crop rapidly to the desired position.
Create copy		Save the current crop as a separate file.

Trim: Image Quality and Size

Copies created from NEF (RAW) or NEF (RAW) + JPEG photos have an image quality (115) of JPEG fine; cropped copies created from JPEG photos have the same image quality as the original. The size of the copy varies with crop size and aspect ratio and appears at upper left in the crop display.






Viewing Cropped Copies

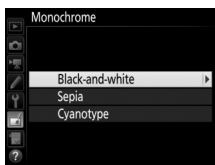
Playback zoom may not be available when cropped copies are displayed.

Monochrome

MENU button →  retouch menu

Copy photographs in **Black-and-white**, **Sepia**, or **Cyanotype** (blue and white monochrome).

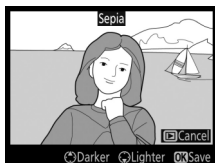
Selecting **Sepia** or **Cyanotype** displays a preview of the selected image; press  to increase color saturation,  to decrease. Press  to create a monochrome copy.



Increase saturation





Decrease saturation

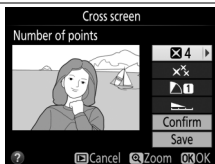




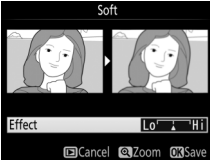
Filter Effects

MENU button →  retouch menu

Choose from the following filter effects. After adjusting filter effects as described below, press **OK** to save the retouched copy.

Option	Description
Skylight	Creates the effect of a skylight filter, making the picture less blue. The effect can be previewed in the monitor as shown at right.
Warm filter	Creates a copy with warm tone filter effects, giving the copy a “warm” red cast. The effect can be previewed in the monitor.
Red intensifier	Intensify reds (Red intensifier), greens (Green intensifier), or blues (Blue intensifier). Press  to increase the effect,  to decrease.
Green intensifier	
Blue intensifier	
Cross screen	<p>Add starburst effects to light sources.</p> <ul style="list-style-type: none"> • Number of points: Choose from four, six, or eight. • Filter amount: Choose the brightness of the light sources affected. • Filter angle: Choose the angle of the points. • Length of points: Choose the length of points. • Confirm: Preview the effects of the filter. Press QUAL to preview the copy full frame. • Save: Create a retouched copy.

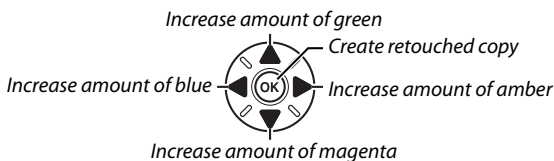
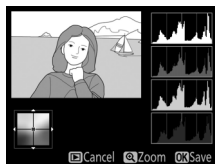


Option	Description
Soft	Add a soft filter effect. Press  or  to choose the filter strength. 

Color Balance

MENU button →  retouch menu

Use the multi selector to create a copy with modified color balance as shown below. The effect is displayed in the monitor together with red, green, and blue histograms (📖 250) giving the distribution of tones in the copy.



Zoom





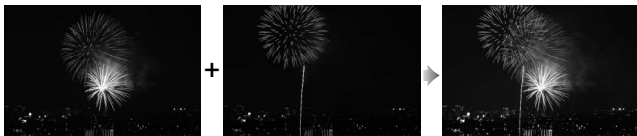
To zoom in on the image displayed in the monitor, press  (**QUAL**). The histogram will be updated to show data only for the portion of the image displayed in the monitor. While the image is zoomed in, press  (**WB**) to toggle back and forth between color balance and zoom. When zoom is selected, you can zoom in and out with the  (**QUAL**) and  (**ISO**) and scroll the image with the multi selector.





Image Overlay

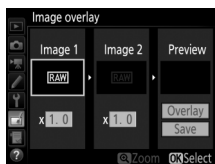
MENU button →  retouch menu

Image overlay combines two existing NEF (RAW) photographs to create a single picture that is saved separately from the originals; the results, which make use of RAW data from the camera image sensor, are noticeably better than overlays created in an imaging application. The new picture is saved at current image quality and size settings; before creating an overlay, set image quality and size (☰ 115, 118; all options are available). To create a NEF (RAW) copy, choose an image quality of **NEF (RAW)**.



1 Select Image overlay.

Highlight **Image overlay** in the retouch menu and press . The dialog shown at right will be displayed, with **Image 1** highlighted; press  to display a picture selection dialog listing only NEF (RAW) images created with this camera.



2 Select the first image.

Use the multi selector to highlight the first photograph in the overlay. To view the highlighted photograph full frame, press and hold the **Q** (**QUAL**) button. Press **OK** to select the highlighted photograph and return to the preview display.

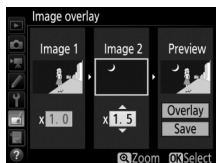


3 Select the second image.







The selected image will appear as **Image 1**. Highlight **Image 2** and press **Q**, then select the second photo as described in Step 2.

4 Adjust gain.

Highlight **Image 1** or **Image 2** and optimize exposure for the overlay by pressing **▲** or **▼** to select gain from values between 0.1 and 2.0. Repeat for the second image. The default value is 1.0; select 0.5 to halve gain or 2.0 to double it. The effects are visible in the **Preview** column.



5 Preview the overlay.

Press  or  to place the cursor in the **Preview** column and press  or  to highlight **Overlay**. Press  to preview the overlay as shown at right (to save the overlay without displaying a preview, select **Save**). To return to Step 4 and select new photos or adjust gain, press  (**ISO**).



6 Save the overlay.


Press  while the preview is displayed to save the overlay. After an overlay is created, the resulting image will be displayed full-frame in the monitor.



Image Overlay

Only NEF (RAW) photographs with the same image area and bit depth can be combined.


The overlay has the same photo info (including date of recording, metering, shutter speed, aperture, shooting mode, exposure compensation, focal length, and image orientation), and values for white balance and Picture Control as the photograph selected for **Image 1**. The current image comment is appended to the overlay when it is saved; copyright information, however, is not copied. Overlays saved in NEF (RAW) format use the compression selected for **Type** in the **NEF (RAW) recording** menu and have the same bit depth as the original images; JPEG overlays are saved using size-priority compression.

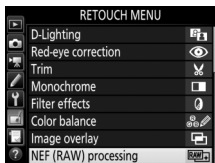
NEF (RAW) Processing

MENU button →  retouch menu



Create JPEG copies of NEF (RAW) photographs.

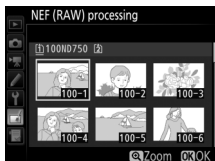
1 Select NEF (RAW) processing.

Highlight **NEF (RAW) processing** in the retouch menu and press  to display a picture selection dialog listing only NEF (RAW) images created with this camera.



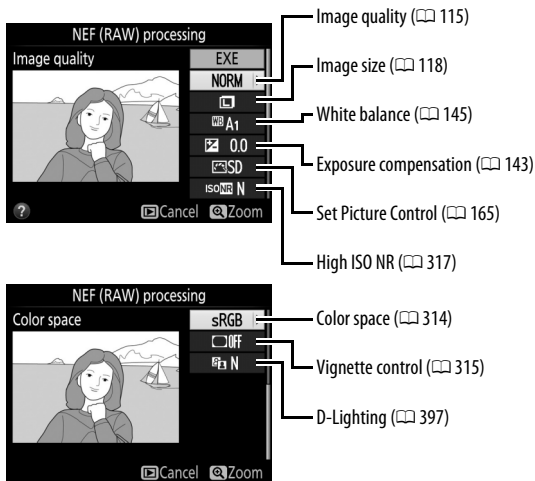
2 Select a photograph.

Use the multi selector to highlight a photograph (to view the highlighted photograph full frame, press and hold the  button). Press  to select the highlighted photograph and proceed to the next step.



3 Choose settings for the JPEG copy.

Adjust the settings listed below. Note that white balance and vignette control are not available with multiple exposures or pictures created with image overlay and that exposure compensation can only be set to values between -2 and $+2$ EV.



4 Copy the photograph.

Highlight **EXE** and press **OK** to create a JPEG copy of the selected photograph (to exit without copying the photograph, press the **MENU** button).




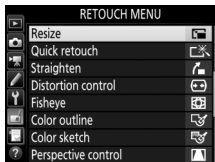
Resize

MENU button →  retouch menu


Create small copies of selected photographs.


1 Select Resize.

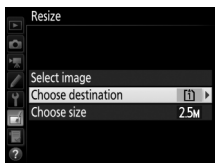
To resize selected images, highlight **Resize** in the retouch menu and press .



2 Choose a destination.

If two memory cards are inserted, you can choose a destination for the resized copies by highlighting **Choose destination** and pressing  (if only one card is inserted, proceed to Step 3).

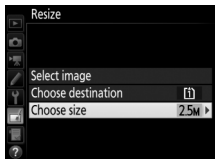
The menu shown at right will be displayed; highlight a card slot and press .



3 Choose a size.

Highlight **Choose size** and press **OK**.

The options shown at right will be displayed; highlight an option and press **OK**.

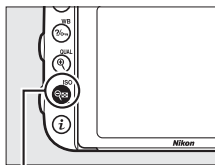
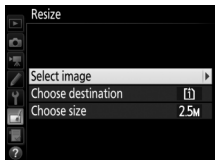


4 Choose pictures.

Highlight **Select image** and press **OK**.

Highlight pictures using the multi selector and press the **ISO** button to select or deselect (to view the highlighted picture full screen, press and hold the **QUAL** button).

Selected pictures are marked by a **ISO** icon. Press **OK** when the selection is complete.



ISO button



5 Save the resized copies.

A confirmation dialog will be displayed. Highlight **Yes** and press **OK** to save the resized copies.



Viewing Resized Copies

Playback zoom may not be available when resized copies are displayed.




Image Quality

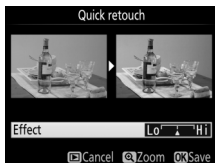
Copies created from NEF (RAW) or NEF (RAW) + JPEG photos have an image quality (📖 115) of JPEG fine; copies created from JPEG photos have the same image quality as the original.

Quick Retouch

MENU button →  retouch menu




Create copies with enhanced saturation and contrast. D-Lighting is applied as required to brighten dark or backlit subjects.

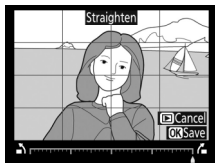
Press  or  to choose the amount of enhancement. The effect can be previewed in the edit display. Press  to save the retouched copy.



Straighten




MENU button →  retouch menu

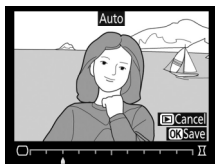
Create a straightened copy of the selected image. Press  to rotate the image clockwise by up to five degrees in increments of approximately 0.25 degrees,  to rotate it counterclockwise (the effect can be previewed in the edit display; note that edges of the image will be trimmed to create a square copy). Press  to save the retouched copy.



Distortion Control

MENU button →  retouch menu

Create copies with reduced peripheral distortion. Select **Auto** to let the camera correct distortion automatically and then make fine adjustments using the multi-selector, or select **Manual** to reduce distortion manually (note that **Auto** is not available with photos taken using auto distortion control; see page 316). Press  to reduce barrel distortion,  to reduce pin-cushion distortion (the effect can be previewed in the edit display; note that greater amounts of distortion control result in more of the edges being cropped out). Press  to save the retouched copy. Note that distortion control may heavily crop or distort the edges of copies created from photographs taken with DX lenses at image areas other than **DX (24×16)**.






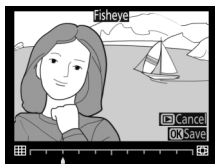
Auto

Auto is for use only with pictures taken with type G, E, and D lenses (PC, fisheye, and certain other lenses excluded). Results are not guaranteed with other lenses.

Fisheye


MENU button →  retouch menu

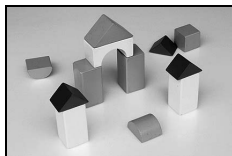
Create copies that appear to have been taken with a fisheye lens. Press  to increase the effect (this also increases the amount of that will be cropped out at the edges of the image),  to reduce it. The effect can be previewed in the edit display. Press  to save the retouched copy.



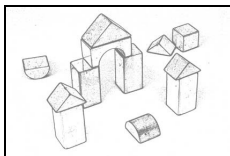
Color Outline

MENU button →  retouch menu

Create an outline copy of a photograph to use as a base for painting. The effect can be previewed in the edit display. Press  to save the retouched copy.








Before

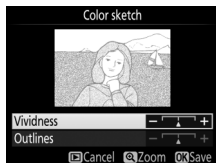


After

Color Sketch


MENU button →  retouch menu

Create a copy of a photograph that resembles a sketch made with colored pencils. Press  or  to highlight **Vividness** or **Outlines** and press  or  to change. Vividness can be increased to make colors more saturated, or decreased for a washed-out, monochromatic effect, while outlines can be made thicker or thinner. Thicker outlines makes colors more saturated. The results can be previewed in the edit display. Press  to save the retouched copy.



Perspective Control

MENU button →  retouch menu

Create copies that reduce the effects of perspective taken from the base of a tall object. Use the multi selector to adjust perspective (note that greater amounts of perspective control result in more of the edges being cropped out). The results can be previewed in the edit display. Press  to save the retouched copy.



Before



















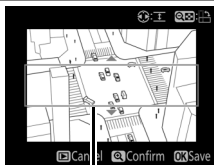
After

Miniature Effect

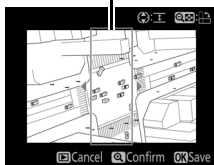
MENU button →  retouch menu

Create a copy that appears to be a photo of a diorama. Works best with photos taken from a high vantage point. The area that will be in focus in the copy is indicated by a yellow frame.

To	Press	Description
Choose orientation	 (ISO)	Press  (ISO) to choose orientation of area that is in focus.
Choose position		If area of effect is in wide orientation, press  or  to position frame showing area of copy that will be in focus.
		If area of effect is in tall orientation, press  or  to position frame showing area of copy that will be in focus.
Choose size		If area of effect is in wide orientation, press  or  to choose height.
		If area of effect is in tall orientation, press  or  to choose width.
Preview copy	 (QUAL)	Preview copy.
Create copy		Create copy.



Area in focus




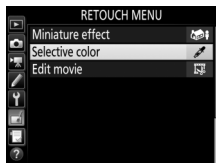
Selective Color

MENU button →  retouch menu



Create a copy in which only selected hues appear in color.

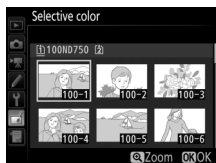
1 Select Selective color.

Highlight **Selective color** in the retouch menu and press  to display a picture selection dialog.






2 Select a photograph.

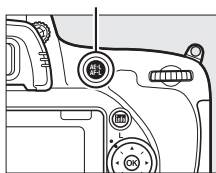
Use the multi selector to highlight a photograph (to view the highlighted photograph full frame, press and hold the /QUAL button). Press  to select the highlighted photograph and proceed to the next step.



3 Select a color.

Use the multi selector to position the cursor over an object and press the  **AE-L/AF-L** button to select the color of the object as one that will remain in the final copy (the camera may have difficulty detecting unsaturated colors; choose a saturated color). To zoom in on the picture for precise color selection, press  (**QUAL**). Press  (**ISO**) to zoom out.

 **AE-L/AF-L** button



Selected color



4 Highlight the color range.

Rotate the main command dial to highlight the color range for the selected color.



Color range



5 Choose the color range.

Press or to increase or decrease the range of similar hues that will be included in the final photograph. Choose from values between 1 and 7; note that higher values may include hues from other colors. The effect can be previewed in the edit display.



6 Select additional colors.

To select additional colors, rotate the main command dial to highlight another of the three color boxes at the top of the display and repeat Steps 3–5 to select another color. Repeat for a third color if desired. To deselect the highlighted color, press (**FORMAT**); to remove all colors, press and hold (**FORMAT**). A confirmation dialog will be displayed; select **Yes**.



7 Save the edited copy.


Press **OK** to save the retouched copy.

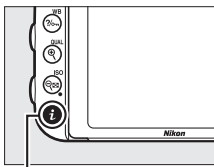


Side-by-side Comparison

Compare retouched copies to the original photographs. This option is only available if the retouch menu is displayed by pressing the **i** button and selecting **Retouch** when a copy or original is played back full frame.

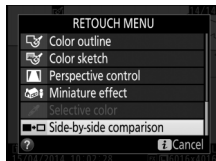
1 Select a picture.

Select a retouched copy (shown by a  icon) or a photograph that has been retouched in full-frame playback. Press **i**, then highlight **Retouch** and press **OK**.



i button

- 2 Select Side-by-side comparison.**
Highlight **Side-by-side comparison** and press **OK**.



- 3 Compare the copy with the original.**

The source image is displayed on the left, the retouched copy on the right, with the options used to create the copy listed at the top of the display.

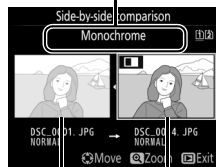
Press **◀** or **▶** to switch between the source image and the retouched copy.

To view the highlighted picture full frame, press and hold the **QUAL** button. If the copy was created from two source images using **Image overlay**,

or if the source has been copied multiple times,

press **▲** or **▼** to view the other source images or copies. To exit to playback mode, press the **▶** button, or press **OK** to exit to playback with the highlighted image selected.

Options used to create copy



Source image

Retouched copy

✔ Side-by-side Comparisons

The source image will not be displayed if the copy was created from a photograph that was protected (☐ 257), has since been deleted or hidden (☐ 301), or is on a card in a different slot from that used when the image was created.

☰ My Menu / ☰ Recent Settings

To display My Menu, press **MENU** and select the ☰ (My Menu) tab.



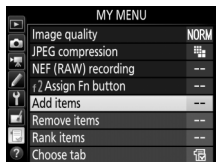
The **MY MENU** option can be used to create and edit a customized list of options from the playback, photo shooting, movie shooting, Custom Settings, setup, and retouch menus for quick access (up to 20 items). If desired, recent settings can be displayed in place of My Menu (📖 425).

Options can be added, deleted, and reordered as described below.

■ Adding Options to My Menu

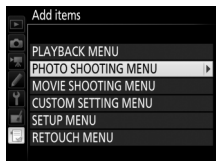
1 Select **Add items**.

In My Menu (☰), highlight **Add items** and press ⏪.



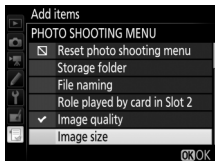
2 Select a menu.

Highlight the name of the menu containing the option you wish to add and press ⏪.



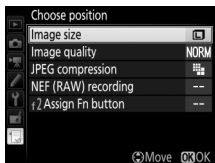
3 Select an item.

Highlight the desired menu item and press **OK**.




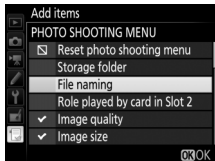
4 Position the new item.

Press **▲** or **▼** to move the new item up or down in My Menu. Press **OK** to add the new item.



5 Add more items.

The items currently displayed in My Menu are indicated by a check mark. Items indicated by a  icon can not be selected. Repeat steps 1–4 to select additional items.



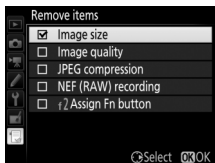
■ Deleting Options from My Menu

1 Select Remove items.

In My Menu (☰), highlight **Remove items** and press (⏎).

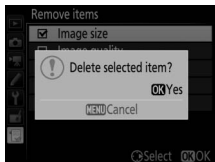
2 Select items.

Highlight items and press (⏎) to select or deselect. Selected items are indicated by a check mark.



3 Delete the selected items.

Press (OK). A confirmation dialog will be displayed; press (OK) again to delete the selected items.



🔪 Deleting Items in My Menu

To delete the item currently highlighted in My Menu, press the (FORMAT) button. A confirmation dialog will be displayed; press (FORMAT) again to remove the selected item from My Menu.

■ Reordering Options in My Menu

1 Select Rank items.

In My Menu (☰), highlight **Rank items** and press (↻).

2 Select an item.

Highlight the item you wish to move and press (OK).



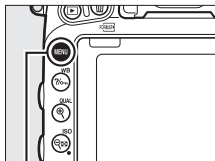
3 Position the item.

Press (▲) or (▼) to move the item up or down in My Menu and press (OK). Repeat Steps 2–3 to reposition additional items.

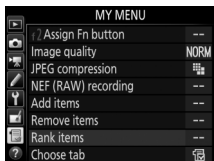


4 Exit to My Menu.

Press the MENU button to return to My Menu.



MENU button





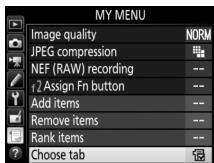
Recent Settings

To display the twenty most recently used settings, select



 **RECENT SETTINGS** for  **MY MENU** > **Choose tab.**

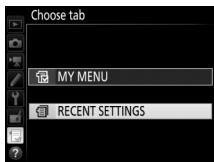
1 Select **Choose tab.**



In My Menu () , highlight **Choose tab** and press .







2 Select **RECENT SETTINGS.**

Highlight  **RECENT SETTINGS** and press . The name of the menu will change from “MY MENU” to “RECENT SETTINGS.”



Menu items will be added to the top of the recent settings menu as they are used. To view My Menu again, select  **MY MENU** for  **RECENT SETTINGS** > **Choose tab.**





Removing Items from the Recent Settings Menu

To remove an item from the recent settings menu, highlight it and press the  () button. A confirmation dialog will be displayed; press  () again to delete the selected item.

Technical Notes

Read this chapter for information on compatible accessories, cleaning and storing the camera, and what to do if an error message is displayed or you encounter problems using the camera.

Compatible Lenses

Camera setting Lens/accessory		Focus mode		Shooting mode		Metering system			
		AF	M (with electronic rangefinder) ¹	P S	A M	 ²		 ³	 ⁵
						3D	Color	 ⁴	
CPU lenses ⁶	Type G, E, or D AF NIKKOR ⁷ AF-S, AF-I NIKKOR	✓	✓	✓	✓	✓	—	✓ ⁸	✓
	PC-E NIKKOR series ⁹	—	✓ ¹⁰	✓ ¹⁰	✓ ¹⁰	✓ ¹⁰	—	✓ ^{8,10}	✓
	PC Micro 85mm f/2.8D ¹¹	—	✓ ¹⁰	—	✓ ¹²	✓	—	✓ ^{8,10}	✓
	AF-S / AF-I Teleconverter ¹³	✓	✓	✓	✓	✓	—	✓ ⁸	✓
	Other AF NIKKOR (except lenses for F3AF)	✓ ¹⁴	✓ ¹⁴	✓	✓	—	✓	✓ ⁸	—
	AI-P NIKKOR	—	✓ ¹⁵	✓	✓	—	✓	✓ ⁸	—

Camera setting Lens/accessory		Focus mode		Shooting mode		Metering system				
		AF	M (with electronic rangefinder) ¹	P S	A M	☒ ²		☐ ³	☐ ⁴	☐ ⁵
						3D	Color			
Non-CPU lenses ¹⁶	AI-, AI-modified NIKKOR or Nikon Series E lenses ¹⁷	—	✓ ¹⁵	—	✓ ¹⁸	—	✓ ¹⁹	✓ ²⁰	—	
	Medical-NIKKOR 120mm f/4	—	✓	—	✓ ²¹	—	—	—	—	
	Reflex-NIKKOR	—	—	—	✓ ¹⁸	—	—	✓ ²⁰	—	
	PC-NIKKOR	—	✓ ¹⁰	—	✓ ²²	—	—	✓	—	
	AI-type Teleconverter ²³	—	✓ ²⁴	—	✓ ¹⁸	—	✓ ¹⁹	✓ ²⁰	—	
	PB-6 Bellows Focusing Attachment ²⁵	—	✓ ²⁴	—	✓ ²⁶	—	—	✓	—	
	Auto extension rings (PK-series 11A, 12, or 13; PN-11)	—	✓ ²⁴	—	✓ ¹⁸	—	—	✓	—	

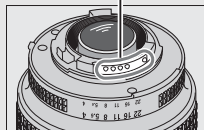
- 1 Manual focus available with all lenses.
- 2 Matrix.
- 3 Center-weighted.
- 4 Spot.
- 5 Highlight-weighted.
- 6 IX-NIKKOR lenses can not be used.
- 7 Vibration Reduction (VR) supported with VR lenses.
- 8 Spot metering meters selected focus point (☐ 139).
- 9 The tilt knob for the PC-E NIKKOR 24mm f/3.5D ED may contact the camera body when the lens is revolved. This can be prevented by installing a smaller tilt knob; contact a Nikon-authorized service representative for more information.
- 10 Can not be used with shifting or tilting.
- 11 The camera's exposure metering and flash control systems do not work properly when shifting and/or tilting the lens, or when an aperture other than the maximum aperture is used.

- 12 Manual shooting mode only.
- 13 Can be used with AF-S and AF-I lenses only (□ 430). For information on the focus points available for autofocus and electronic rangefinding, see page 430.
- 14 When focusing at minimum focus distance with AF 80–200mm f/2.8, AF 35–70mm f/2.8, AF 28–85mm f/3.5–4.5 <New>, or AF 28–85mm f/3.5–4.5 lens at maximum zoom, in-focus indicator may be displayed when image on matte screen in viewfinder is not in focus. Adjust focus manually until image in viewfinder is in focus.
- 15 With maximum aperture of f/5.6 or faster.
- 16 Some lenses can not be used (see page 431).
- 17 Range of rotation for AI 80–200mm f/2.8 ED tripod mount is limited by camera body. Filters can not be exchanged while AI 200–400mm f/4 ED is mounted on camera.
- 18 If maximum aperture is specified using **Non-CPU lens data** (□ 235), aperture value will be displayed in viewfinder and control panel.
- 19 Can be used only if lens focal length and maximum aperture are specified using **Non-CPU lens data** (□ 235). Use spot or center-weighted metering if desired results are not achieved.
- 20 For improved precision, specify lens focal length and maximum aperture using **Non-CPU lens data** (□ 235).
- 21 Can be used in manual mode **M** at shutter speeds slower than flash sync speed by one step or more.
- 22 Exposure determined by presetting lens aperture. In mode **A**, preset aperture using lens aperture ring before performing AE lock and shifting lens. In mode **M**, preset aperture using lens aperture ring and determine exposure before shifting lens.
- 23 Exposure compensation required when used with AI 28–85mm f/3.5–4.5, AI 35–105mm f/3.5–4.5, AI 35–135mm f/3.5–4.5, or AF-S 80–200mm f/2.8D.
- 24 With maximum effective aperture of f/5.6 or faster.
- 25 Requires PK-12 or PK-13 auto extension ring. PB-6D may be required depending on camera orientation.
- 26 Use preset aperture. In mode **A**, set aperture using focusing attachment before determining exposure and taking photograph.
 - PF-4 Reprocopy Outfit requires PA-4 Camera Holder.
 - With some lenses, noise in the form of lines may appear during autofocus at high ISO sensitivities. Use manual focus or focus lock.

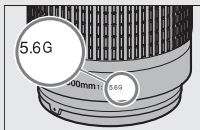
☑ Recognizing CPU and Type G, E, and D Lenses

CPU lenses (particularly types G, E, and D) are recommended, but note that IX-NIKKOR lenses can not be used. CPU lenses can be identified by the presence of CPU contacts, type G, E, and D lenses by a letter on the lens barrel. Type G and E lenses are not equipped with a lens aperture ring.

CPU contacts

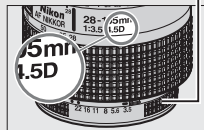


CPU lens



Type G/E lens








Aperture ring



Type D lens

AF-S/AF-I Teleconverters

The table below shows the focus points available for autofocus and electronic rangefinding when an AF-S/AF-I teleconverter is attached. Note that the camera may be unable to focus on dark or low-contrast subjects if the combined aperture is slower than f/5.6. Autofocus is not available when teleconverters are used with the AF-S VR Micro-Nikkor 105mm f/2.8G IF-ED.

Accessory	Maximum aperture of lens	Focus points
TC-14E, TC-14E II, TC-14E III	f/4 or faster	
	f/5.6	 ¹
TC-17E II	f/2.8 or faster	
	f/4	 ¹
	f/5.6	— ²
TC-20E, TC-20E II, TC-20E III	f/2.8 or faster	
	f/4	 ³
	f/5.6	— ²
TC-800-1.25E ED	f/5.6	 ¹

- 1 Single-point AF is used when 3D-tracking or auto-area AF is selected for AF-area mode (□ 123).
- 2 Autofocus not available.
- 3 Focus data for focus points other than the center focus point are obtained from line sensors.

Lens f-number

The f-number given in lens names is the maximum aperture of the lens.

Compatible Non-CPU Lenses

Non-CPU lens data (☐ 235) can be used to enable many of the features available with CPU lenses, including color matrix metering; if no data are provided, center-weighted metering will be used in place of color matrix metering, while if the maximum aperture is not provided, the camera aperture display will show the number of stops from maximum aperture and the actual aperture value must be read off the lens aperture ring.

Incompatible Accessories and Non-CPU Lenses


The following can NOT be used with the D750:

- TC-16A AF teleconverter
- Non-AI lenses
- Lenses that require the AU-1 focusing unit (400mm f/4.5, 600mm f/5.6, 800mm f/8, 1200mm f/11)
- Fisheye (6mm f/5.6, 7.5mm f/5.6, 8mm f/8, OP 10mm f/5.6)
- 2.1cm f/4
- Extension Ring K2
- 180–600mm f/8 ED (serial numbers 174041–174180)
- 360–1200mm f/11 ED (serial numbers 174031–174127)
- 200–600mm f/9.5 (serial numbers 280001–300490)
- AF lenses for the F3AF (AF 80mm f/2.8, AF 200mm f/3.5 ED, AF Teleconverter TC-16)
- PC 28mm f/4 (serial number 180900 or earlier)
- PC 35mm f/2.8 (serial numbers 851001–906200)
- PC 35mm f/3.5 (old type)
- Reflex 1000mm f/6.3 (old type)
- Reflex 1000mm f/11 (serial numbers 142361–143000)
- Reflex 2000mm f/11 (serial numbers 200111–200310)

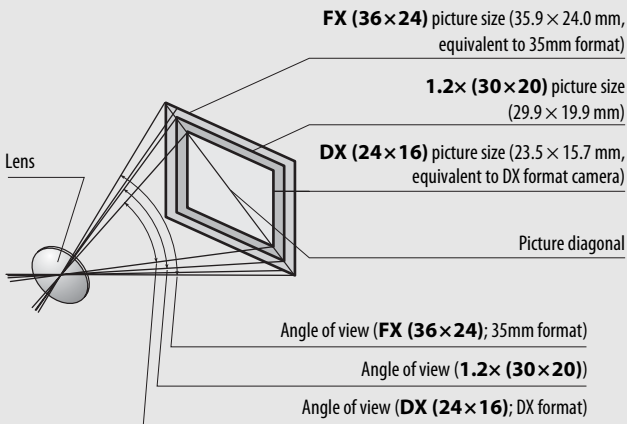
Red-Eye Reduction

Lenses that block the subject's view of the red-eye reduction lamp may interfere with red-eye reduction.

Calculating Angle of View

The D750 can be used with Nikon lenses for 35mm (135) format cameras. If **Auto DX crop** is on ( 111) and a 35mm format lens is attached, the angle of view will be the same as a frame of 35mm film (35.9 × 24.0 mm); if a DX lens is attached, the angle of view will automatically be adjusted to 23.5 × 15.7 mm (DX format).

To choose an angle of view different from that of the current lens, turn **Auto DX crop** off and select from **FX (36×24)**, **1.2× (30×20)**, and **DX (24×16)**. If a 35mm format lens is attached, the angle of view could be reduced by 1.5 × by selecting **DX (24×16)** or by 1.2 × by selecting **1.2× (30×20)** to expose a smaller area.



The **DX (24×16)** angle of view is about 1.5 times smaller than the 35mm format angle of view, while the **1.2× (30×20)** angle of view is about 1.2 times smaller. To calculate the focal length of lenses in 35mm format when **DX (24×16)** is selected, multiply the focal length of the lens by about 1.5 or by about 1.2 when **1.2× (30×20)** is selected (for example, the effective focal length of a 50mm lens in 35mm format would be 75 mm when **DX (24×16)** is selected or 60 mm when **1.2× (30×20)** is selected).

Optional Flash Units (Speedlights)

The camera supports the Nikon Creative Lighting System (CLS) and can be used with CLS-compatible flash units. The built-in flash will not fire when an optional flash unit is attached.

The Nikon Creative Lighting System (CLS)



Nikon's advanced Creative Lighting System (CLS) offers improved communication between the camera and compatible flash units for improved flash photography.

■ ■ CLS-Compatible Flash Units

The camera can be used with the following CLS-compatible flash units:

- **The SB-910, SB-900, SB-800, SB-700, SB-600, SB-500, SB-400, SB-300, and SB-R200:**

Flash unit	SB-910, SB-900 ¹	SB-800	SB-700 ¹	SB-600	SB-500 ²	SB-400 ³	SB-300 ³	SB-R200 ⁴
Feature								
Guide No. (ISO 100) ⁵	34/111	38/125	28/92	30/98	24/78	21/69	18/59	10/33

- 1 If a color filter is attached to the SB-910, SB-900, or SB-700 when **AUTO** or  (flash) is selected for white balance, the camera will automatically detect the filter and adjust white balance appropriately.
- 2 Users of the LED light can set camera white balance to **AUTO** or  for optimal results.
- 3 Wireless flash control is not available.
- 4 Controlled remotely with built-in flash in commander mode or using optional SB-910, SB-900, SB-800, SB-700, or SB-500 flash unit or SU-800 wireless Speedlight commander.
- 5 m/ft, 20 °C (68 °F), SB-910, SB-900, SB-800, SB-700, and SB-600 at 35 mm zoom head position; SB-910, SB-900, and SB-700 with standard illumination.

- **SU-800 Wireless Speedlight Commander:** When mounted on a CLS-compatible camera, the SU-800 can be used as a commander for remote SB-910, SB-900, SB-800, SB-700, SB-600, SB-500, or SB-R200 flash units in up to three groups. The SU-800 itself is not equipped with a flash.

Guide Number

To calculate the range of the flash at full power, divide the Guide Number by the aperture. If, for example, the flash unit has a Guide Number of 34 m or 111 ft (ISO 100, 20 °C/68 °F); its range at an aperture of f/5.6 is $34 \div 5.6$ or about 6.1 meters (or in feet, $111 \div 5.6 =$ approximately 19 ft 10 in.). For each twofold increase in ISO sensitivity, multiply the Guide Number by the square root of two (approximately 1.4).

The AS-15 Sync Terminal Adapter

When the AS-15 sync terminal adapter (available separately) is mounted on the camera accessory shoe, flash accessories can be connected via a sync terminal.

The following features are available with CLS-compatible flash units:


		SB-910, SB-900, SB-800	SB-700	SB-600	SB-500	SU-800	SB-R200	SB-400	SB-300		
Single flash	i-TTL	i-TTL balanced fill-flash for digital SLR ¹	✓	✓	✓	✓	—	—	✓	✓	
		Standard i-TTL flash for digital SLR	✓ ²	✓	✓ ²	✓	—	—	✓	✓	
	AA	Auto aperture	✓ ³	—	—	—	—	—	—	—	
	A	Non-TTL auto	✓ ³	—	—	—	—	—	—	—	
	GN	Distance-priority manual	✓	✓	—	—	—	—	—	—	
	M	Manual	✓	✓	✓	✓ ⁴	—	—	✓ ⁴	✓ ⁴	
	RPT	Repeating flash	✓	—	—	—	—	—	—	—	
Advanced Wireless Lighting	Master	Remote flash control	✓	✓	—	✓ ⁴	✓	—	—	—	
		i-TTL i-TTL	✓	✓	—	✓ ⁴	—	—	—	—	
		[A:B]	Quick wireless flash control	—	✓	—	—	✓ ⁵	—	—	—
		AA	Auto aperture	✓ ⁶	—	—	—	—	—	—	—
		A	Non-TTL auto	✓	—	—	—	—	—	—	—
		M	Manual	✓	✓	—	✓ ⁴	—	—	—	—
		RPT	Repeating flash	✓	—	—	—	—	—	—	
	Remote	i-TTL	i-TTL	✓	✓	✓	✓	—	✓	—	—
		[A:B]	Quick wireless flash control	✓	✓	✓	✓	—	✓	—	—
		AA	Auto aperture	✓ ⁶	—	—	—	—	—	—	—
		A	Non-TTL auto	✓	—	—	—	—	—	—	—
		M	Manual	✓	✓	✓	✓	—	✓	—	—
		RPT	Repeating flash	✓	✓	✓	✓	—	—	—	—

	SB-910, SB-900, SB-800	SB-700	SB-600	SB-500	SU-800	SB-R200	SB-400	SB-300
Color Information Communication (flash)	✓	✓	✓	✓	—	—	✓	✓
Color Information Communication (LED light)	—	—	—	✓	—	—	—	—
Auto FP High-Speed Sync ⁷	✓	✓	✓	✓	✓	✓	—	—
FV lock ⁸	✓	✓	✓	✓	✓	✓	✓	✓
AF-assist for multi-area AF	✓	✓	✓	—	✓ ⁹	—	—	—
Red-eye reduction	✓	✓	✓	✓	—	—	✓	—
Camera modeling illumination	✓	✓	✓	✓	✓	✓	—	—
Camera flash mode selection	—	—	—	✓	—	—	✓	✓
Camera flash unit firmware update	✓ ¹⁰	✓	—	✓	—	—	—	✓

- 1 Not available with spot metering.
- 2 Can also be selected with flash unit.
- 3 AA/A mode selection performed on flash unit using custom settings. Unless lens data have been provided using the **Non-CPU lens data** option in the setup menu, "A" will be selected when a non-CPU lens is used.
- 4 Can only be selected with camera.
- 5 Available only during close-up photography.
- 6 Unless lens data have been provided using the **Non-CPU lens data** option in the setup menu, non-TTL auto (A) is used with non-CPU lenses, regardless of mode selected with flash unit.
- 7 Available only in i-TTL, AA, A, GN, and M flash-control modes.
- 8 Available only in i-TTL, AA, and A flash-control modes.
- 9 Available only in commander mode.
- 10 Firmware updates for the SB-910 and SB-900 can be performed from the camera.

■ ■ Other Flash Units

The following flash units can be used in non-TTL auto and manual modes.

Flash unit		SB-80DX, SB-28DX, SB-28, SB-26, SB-25, SB-24	SB-50DX ¹	SB-30, SB-27 ² , SB-22S, SB-22, SB-20, SB-16B, SB-15	SB-23, SB-29 ³ , SB-21B ³ , SB-29S ³
		Flash mode			
A	Non-TTL auto	✓	—	✓	—
M	Manual	✓	✓	✓	✓
	Repeating flash	✓	—	—	—
REAR	Rear-curtain sync⁴	✓	✓	✓	✓

1 Select mode **P**, **S**, **A**, or **M**, lower built-in flash, and use optional flash unit only.




2 Flash mode is automatically set to TTL and shutter-release is disabled. Set flash unit to **A** (non-TTL auto flash).

3 Autofocus is available with AF-S VR Micro-Nikkor 105mm f/2.8G IF-ED and AF-S Micro NIKKOR 60mm f/2.8G ED lenses only.

4 Available when camera is used to select flash mode.

✔ Notes on Optional Flash Units

Refer to the flash unit manual for detailed instructions. If the flash unit supports CLS, refer to the section on CLS-compatible digital SLR cameras. The D750 is not included in the “digital SLR” category in the SB-80DX, SB-28DX, and SB-50DX manuals.

If an optional flash unit is attached in shooting modes other than , , and , the flash will fire with every shot, even in modes in which the built-in flash can not be used.




i-TTL flash control can be used at ISO sensitivities between 100 and 12800. At values under 100 or over 12800, the desired results may not be achieved at some ranges or aperture settings. If the flash-ready indicator flashes for about three seconds after a photograph is taken in i-TTL or non-TTL auto mode, the flash has fired at full power and the photograph may be underexposed (CLS-compatible flash units only; for information on the exposure and flash charge indicators on other units, see the manual provided with the flash).

When an SC-series 17, 28, or 29 sync cable is used for off-camera flash photography, correct exposure may not be achieved in i-TTL mode. We recommend that you select standard i-TTL flash control. Take a test shot and view the results in the monitor.

In i-TTL, use the flash panel or bounce adapter provided with the flash unit. Do not use other panels such as diffusion panels, as this may produce incorrect exposure.

The SB-910, SB-900, SB-800, SB-700, SB-600, SB-500, and SB-400 provide red-eye reduction, while the SB-910, SB-900, SB-800, SB-700, SB-600, and SU-800 provide AF-assist illumination with the following restrictions:

- **SB-910 and SB-900:** AF-assist illumination is available with 17–135 mm AF lenses, however, autofocus is available only with the focus points shown at right.

17–19 mm	
20–105 mm	
106–135 mm	

- **SB-800, SB-600, and SU-800:** AF-assist illumination is available with 24–105 mm AF lenses, however, autofocus is available only with the focus points shown at right.

24–34 mm	
35–49 mm	
50–105 mm	

- **SB-700:** AF-assist illumination is available with 24–135 mm AF lenses, however, autofocus is available only with the focus points shown at right.

24–27 mm	
28–135 mm	

Depending on the lens used and scene recorded, the in-focus indicator (●) may be displayed when the subject is not in focus, or the camera may be unable to focus and the shutter release will be disabled.














In mode **P**, the maximum aperture (minimum f-number) is limited according to ISO sensitivity, as shown below:

Maximum aperture at ISO equivalent of:							
100	200	400	800	1600	3200	6400	12800
4	4.8	5.6	6.7	8	9.5	11	13

If the maximum aperture of the lens is smaller than given above, the maximum value for aperture will be the maximum aperture of the lens.

Flash Control Mode

The information display shows the flash control mode for optional flash units attached to the camera accessory shoe as follows:

	Flash sync	Auto FP (☐ 345)
i-TTL		
Auto aperture (AA)		
Non-TTL auto flash (A)		
Distance-priority manual (GN)		
Manual		
Repeating flash		—
Advanced wireless lighting		

Use Only Nikon Flash Accessories

Use only Nikon flash units. Negative voltages or voltages over 250 V applied to the accessory shoe could not only prevent normal operation, but damage the sync circuitry of the camera or flash. Before using a Nikon flash unit not listed in this section, contact a Nikon-authorized service representative for more information.

Other Accessories

At the time of writing, the following accessories were available for the D750.

Power sources

- **Rechargeable Li-ion Battery EN-EL15** (□ 25, 26): Additional EN-EL15 batteries are available from local retailers and Nikon-authorized service representatives.
- **Battery Charger MH-25a** (□ 25): The MH-25a can be used to recharge EN-EL15 batteries. MH-25 battery chargers can also be used.
- **Multi-Power Battery Pack MB-D16**: The MB-D16 is equipped with a shutter-release button, AE/AF lock button, multi selector, and main- and sub-command dials for improved operation when taking photographs in portrait (tall) orientation. When attaching the MB-D16, remove the camera MB-D16 contact cover.
- **Power Connector EP-5B, AC Adapter EH-5b**: These accessories can be used to power the camera for extended periods (EH-5a and EH-5 AC adapters can also be used). The EP-5B is required to connect the camera to the EH-5b; see page 445 for details. Note that when the camera is used with an MB-D16, the EP-5B must be inserted into the MB-D16, not the camera. Do not attempt to use the camera with power connectors inserted into both the camera and MB-D16.

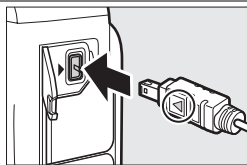
Filters	<ul style="list-style-type: none"> • Filters intended for special-effects photography may interfere with autofocus or the electronic rangefinder. • The D750 can not be used with linear polarizing filters. Use C-PL or C-PL II circular polarizing filters instead. • Use NC filters to protect the lens. • To prevent ghosting, use of a filter is not recommended when the subject is framed against a bright light, or when a bright light source is in the frame. • Center-weighted metering is recommended with filters with exposure factors (filter factors) over 1 × (Y44, Y48, Y52, O56, R60, X0, X1, C-PL, ND25, ND4, ND45, ND8, ND85, ND400, A2, A12, B2, B8, B12). See the filter manual for details.
LAN adapters (📖 269)	<ul style="list-style-type: none"> • Communication Unit UT-1: Use a USB cable to connect the UT-1 to the camera and an Ethernet cable to connect the UT-1 to an Ethernet network. Once connected, you can upload photos and movies to a computer or ftp server, control the camera remotely using optional Camera Control Pro 2 software, or browse pictures or control the camera remotely from an iPhone or computer web browser. • Wireless Transmitter WT-5: Attach the WT-5 to the UT-1 to access wireless networks. <p>Note: Use of LAN adapters requires an Ethernet or wireless network and some basic network knowledge. Be sure to upgrade any related software to the latest version.</p>
HDMI cables (📖 277)	<p>HDMI Cable HC-E1: An HDMI cable with a type C connector for connection to the camera and a type A connector for connection to HDMI devices.</p>
Accessory shoe covers	<p>Accessory Shoe Cover BS-1: A cover protecting the accessory shoe. The accessory shoe is used for optional flash units.</p>
Body cap	<p>Body Cap BF-1B/Body Cap BF-1A: The body cap keeps the mirror, viewfinder screen, and low-pass filter free of dust when a lens is not in place.</p>

Viewfinder eyepiece accessories

- **DK-20C Eyepiece Correction Lenses:** Lenses are available with diopters of -5 , -4 , -3 , -2 , 0 , $+0.5$, $+1$, $+2$, and $+3$ m^{-1} when the camera diopter adjustment control is in the neutral position (-1 m^{-1}). Use eyepiece correction lenses only if the desired focus can not be achieved with the built in diopter adjustment control (-3 to $+1$ m^{-1}). Test eyepiece correction lenses before purchase to ensure that the desired focus can be achieved. The rubber eyecup can not be used with eyepiece correction lenses.
- **Magnifying Eyepiece DK-21M:** The DK-21M magnifies the view through the viewfinder by approximately $1.17 \times$ (50 mm $f/1.4$ lens at infinity; -1.0 m^{-1}) for greater precision when framing.
- **Magnifier DG-2:** The DG-2 magnifies the scene displayed in the center of the viewfinder for greater precision during focusing. Eyepiece adapter required (available separately).
- **Eyepiece Adapter DK-22:** The DK-22 is used when attaching the DG-2 magnifier.
- **Right-Angle Viewing Attachment DR-6:** The DR-6 attaches at a right angle to the viewfinder eyepiece, allowing the image in the viewfinder to be viewed at right angles to the lens (for example, from directly above when the camera is horizontal).

Accessory terminal accessories

The D750 is equipped with an accessory terminal for **WR-1** and **WR-R10 wireless remote controllers** (□ 197, 444), **MC-DC2 remote cords** (□ 95), and **GP-1** and **GP-1A GPS units** (□ 239), which connect with the ◀ mark on the connector aligned with the ▶ next to the accessory terminal (close the camera connector cover when the terminal is not in use).



Microphones

Stereo Microphone ME-1 (□ 73)

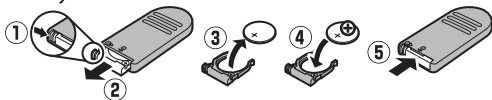
Software

Camera Control Pro 2: Control the camera remotely from a computer to record movies and photographs and save photographs directly to the computer hard disk. When Camera Control Pro 2 is used to capture photographs directly to the computer, the PC connection indicator (P Σ) will appear in the control panel.

Note: Use the latest versions of Nikon software; see the websites listed on page xxiii for the latest information on supported operating systems. At default settings, Nikon Message Center 2 will periodically check for updates to Nikon software and firmware while you are logged in to an account on the computer and the computer is connected to the Internet. A message is automatically displayed when an update is found.

Remote controls/ wireless remote controller (193)

- **Wireless Remote Control ML-L3:** The ML-L3 uses a 3 V CR2025 battery.



Pressing the battery-chamber latch to the right (1), insert a fingernail into the gap and open the battery chamber (2). Ensure that the battery is inserted in the correct orientation (4).

- **Wireless Remote Controller WR-R10/WR-T10:** When a WR-R10 wireless remote controller is attached, the camera can be controlled wirelessly using a WR-T10 wireless remote controller.
- **Wireless Remote Controller WR-1:** The WR-1 can function as either a transmitter or a receiver and is used in combination either with another WR-1 or a WR-R10 or WR-T10 wireless remote controller. For example, a WR-1 can be connected to the accessory terminal for use as a receiver, allowing camera settings to be changed or the shutter to be released remotely by another WR-1 acting as a transmitter.

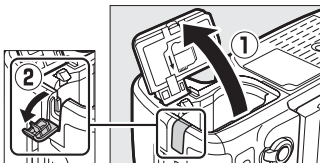
Availability may vary with country or region. See our website or brochures for the latest information.

Attaching a Power Connector and AC Adapter

Turn the camera off before attaching an optional power connector and AC adapter.

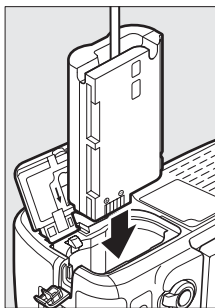
1 Ready the camera.

Open the battery-chamber cover (1) and power connector (2) covers.



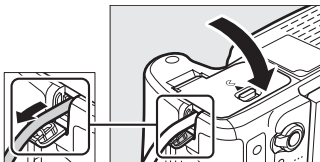
2 Insert the EP-5B power connector.

Be sure to insert the connector in the orientation shown, using the connector to keep the orange battery latch pressed to one side. The latch locks the connector in place when the connector is fully inserted.




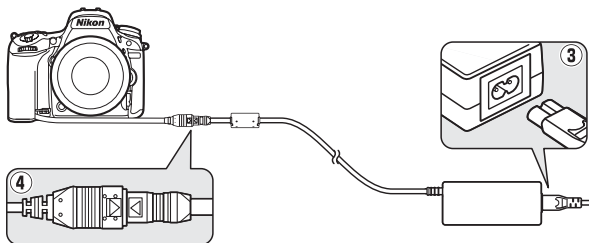
3 Close the battery-chamber cover.

Position the power connector cable so that it passes through the power connector slot and close the battery-chamber cover.



4 Connect the EH-5b AC adapter.

Connect the AC adapter power cable to the AC socket (3) and the power cable to the DC socket (4). A  icon is displayed in the monitor when the camera is powered by the AC adapter and power connector.



Caring for the Camera

Storage

When the camera will not be used for an extended period, remove the battery and store it in a cool, dry area with the terminal cover in place. To prevent mold or mildew, store the camera in a dry, well-ventilated area. Do not store your camera with naphtha or camphor moth balls or in locations that:

- are poorly ventilated or subject to humidities of over 60%
- are next to equipment that produces strong electromagnetic fields, such as televisions or radios
- are exposed to temperatures above 50 °C (122 °F) or below -10 °C (14 °F)

Cleaning

Camera body	Use a blower to remove dust and lint, then wipe gently with a soft, dry cloth. After using the camera at the beach or seaside, wipe off sand or salt with a cloth lightly dampened in distilled water and dry thoroughly. Important: <i>Dust or other foreign matter inside the camera may cause damage not covered under warranty.</i>
Lens, mirror, and viewfinder	These glass elements are easily damaged. Remove dust and lint with a blower. If using an aerosol blower, keep the can vertical to prevent the discharge of liquid. To remove fingerprints and other stains, apply a small amount of lens cleaner to a soft cloth and clean with care.
Monitor	Remove dust and lint with a blower. When removing fingerprints and other stains, wipe the surface lightly with a soft cloth or chamois leather. Do not apply pressure, as this could result in damage or malfunction.

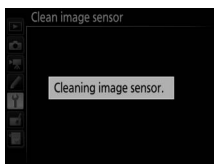
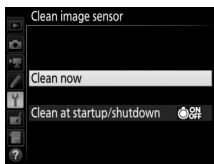
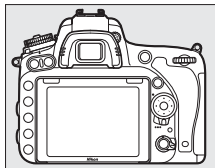
Do not use alcohol, thinner, or other volatile chemicals.

The Low-Pass Filter

The image sensor that acts as the camera's picture element is fitted with a low-pass filter to prevent moiré. If you suspect that dirt or dust on the filter is appearing in photographs, you can clean the filter using the **Clean image sensor** option in the setup menu. The filter can be cleaned at any time using the **Clean now** option, or cleaning can be performed automatically when the camera is turned on or off.




■ ■ "Clean Now"

Holding the camera base down, select **Clean image sensor** in the setup menu, then highlight **Clean now** and press **OK**. The camera will check the image sensor and then begin cleaning. Other operations can not be performed while cleaning is in progress. Do not remove or disconnect the power source until cleaning ends and the setup menu is displayed.




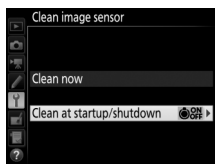
■ ■ “Clean at Startup/Shutdown”

Choose from the following options:

Option	Description
 Clean at startup	The image sensor is automatically cleaned each time the camera is turned on.
 Clean at shutdown	The image sensor is automatically cleaned during shutdown each time the camera is turned off.
 Clean at startup & shutdown	The image sensor is cleaned automatically at startup and at shutdown.
Cleaning off	Automatic image sensor cleaning off.

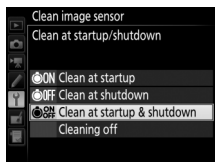
1 Select **Clean at startup/shutdown**.

Display the **Clean image sensor** menu as described on page 448. Highlight **Clean at startup/shutdown** and press .



2 Select an option.

Highlight an option and press .



✔ Image Sensor Cleaning

Using camera controls during startup interrupts image sensor cleaning. Image sensor cleaning may not be performed at startup if the flash is charging.


Cleaning is performed by vibrating the low-pass filter. If dust can not be fully removed using the options in the **Clean image sensor** menu, clean the image sensor manually (☞ 451) or consult a Nikon-authorized service representative.

If image sensor cleaning is performed several times in succession, image sensor cleaning may be temporarily disabled to protect the camera's internal circuitry. Cleaning can be performed again after a short wait.

Manual Cleaning

If foreign matter can not be removed from the low-pass filter using the **Clean image sensor** option in the setup menu (☰ 448), the filter can be cleaned manually as described below. Note, however, that the filter is extremely delicate and easily damaged. Nikon recommends that the filter be cleaned only by Nikon-authorized service personnel.


1 Charge the battery or connect an AC adapter.

A reliable power source is required when inspecting or cleaning the low-pass filter. Turn the camera off and insert a fully-charged battery or connect an optional AC adapter and power connector. The **Lock mirror up for cleaning** option is only available in the setup menu at battery levels over .

2 Remove the lens.

Turn the camera off and remove the lens.

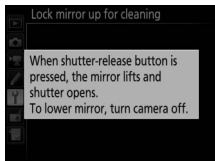
3 Select **Lock mirror up for cleaning**.

Highlight **Lock mirror up for cleaning** in the setup menu and press .



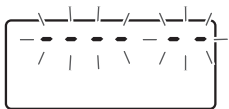
4 Press .

The message shown at right will be displayed in the monitor and a row of dashes will appear in the control panel and viewfinder. To restore normal operation without inspecting the low-pass filter, turn the camera off.



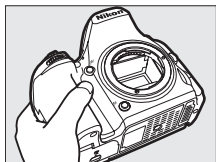
5 Raise the mirror.

Press the shutter-release button all the way down. The mirror will be raised and the shutter curtain will open, revealing the low-pass filter. The display in the viewfinder will turn off and the row of dashes in the control panel will flash.



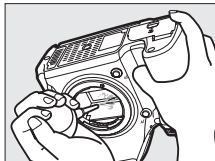
6 Examine the low-pass filter.

Holding the camera so that light falls on the low-pass filter, examine the filter for dust or lint. If no foreign objects are present, proceed to Step 8.



7 Clean the filter.

Remove any dust and lint from the filter with a blower. Do not use a blower-brush, as the bristles could damage the filter. Dirt that can not be removed with a blower can only be removed by Nikon-authorized service personnel. Under no circumstances should you touch or wipe the filter.



8 Turn the camera off.

The mirror will return to the down position and the shutter curtain will close. Replace the lens or body cap.

Use a Reliable Power Source

The shutter curtain is delicate and easily damaged. If the camera powers off while the mirror is raised, the curtain will close automatically. To prevent damage to the curtain, observe the following precautions:

- Do not turn the camera off or remove or disconnect the power source while the mirror is raised.
- If the battery runs low while the mirror is raised, a beep will sound and the self-timer lamp will flash to warn that the shutter curtain will close and the mirror will be lowered after about two minutes. End cleaning or inspection immediately.

✔ Foreign Matter on the Low-Pass Filter

Nikon takes every possible precaution to prevent foreign matter from coming into contact with the low-pass filter during production and shipping. The D750, however, is designed to be used with interchangeable lenses, and foreign matter may enter the camera when lenses are removed or exchanged. Once inside the camera, this foreign matter may adhere to the low-pass filter, where it may appear in photographs taken under certain conditions. To protect the camera when no lens is in place, be sure to replace the body cap provided with the camera, being careful to first remove all dust and other foreign matter that may be adhering to the body cap. Avoid exchanging lenses in dusty environments.

Should foreign matter find its way onto the low-pass filter, clean the filter as described above, or have the filter cleaned by authorized Nikon service personnel. Photographs affected by the presence of foreign matter on the filter can be retouched using the clean image options available in some imaging applications.

✔ Servicing the Camera and Accessories

The camera is a precision device and requires regular servicing. Nikon recommends that the camera be inspected by the original retailer or Nikon-authorized service representative once every one to two years, and that it be serviced once every three to five years (note that fees apply to these services). Frequent inspection and servicing are particularly recommended if the camera is used professionally. Any accessories regularly used with the camera, such as lenses or optional flash units, should be included when the camera is inspected or serviced.

Caring for the Camera and Battery: Cautions

Do not drop: The product may malfunction if subjected to strong shocks or vibration.

Keep dry: This product is not waterproof, and may malfunction if immersed in water or exposed to high levels of humidity. Rusting of the internal mechanism can cause irreparable damage.

Avoid sudden changes in temperature: Sudden changes in temperature, such as those that occur when entering or leaving a heated building on a cold day, can cause condensation inside the device. To prevent condensation, place the device in a carrying case or plastic bag before exposing it to sudden changes in temperature.

Keep away from strong magnetic fields: Do not use or store this device in the vicinity of equipment that generates strong electromagnetic radiation or magnetic fields. Strong static charges or the magnetic fields produced by equipment such as radio transmitters could interfere with the monitor, damage data stored on the memory card, or affect the product's internal circuitry.

Do not leave the lens pointed at the sun: Do not leave the lens pointed at the sun or other strong light source for an extended period. Intense light may cause the image sensor to deteriorate or produce a white blur effect in photographs.

Turn the product off before removing or disconnecting the power source: Do not unplug the product or remove the battery while the product is on or while images are being recorded or deleted. Forcibly cutting power in these circumstances could result in loss of data or in damage to product memory or internal circuitry. To prevent an accidental interruption of power, avoid carrying the product from one location to another while the AC adapter is connected.

Cleaning: When cleaning the camera body, use a blower to gently remove dust and lint, then wipe gently with a soft, dry cloth. After using the camera at the beach or seaside, wipe off any sand or salt using a cloth lightly dampened in pure water and then dry the camera thoroughly. In rare instances, static electricity may cause LCDs to light up or go dark. This does not indicate a malfunction, and the display will soon return to normal.

The lens and mirror are easily damaged. Dust and lint should be gently removed with a blower. When using an aerosol blower, keep the can vertical to prevent discharge of liquid. To remove fingerprints and other stains from the lens, apply a small amount of lens cleaner to a soft cloth and wipe the lens carefully.

See “The Low-Pass Filter” (□ 448, 451) for information on cleaning the low-pass filter.

Lens contacts: Keep the lens contacts clean.

Do not touch the shutter curtain: The shutter curtain is extremely thin and easily damaged. Under no circumstances should you exert pressure on the curtain, poke it with cleaning tools, or subject it to powerful air currents from a blower. These actions could scratch, deform, or tear the curtain.

Storage: To prevent mold or mildew, store the camera in a dry, well-ventilated area. If you are using an AC adapter, unplug the adapter to prevent fire. If the product will not be used for an extended period, remove the battery to prevent leakage and store the camera in a plastic bag containing a desiccant. Do not, however, store the camera case in a plastic bag, as this may cause the material to deteriorate. Note that desiccant gradually loses its capacity to absorb moisture and should be replaced at regular intervals.

To prevent mold or mildew, take the camera out of storage at least once a month. Turn the camera on and release the shutter a few times before putting it away.

Store the battery in a cool, dry place. Replace the terminal cover before putting the battery away.

Notes on the monitor: The monitor is constructed with extremely high precision; at least 99.99% of pixels are effective, with no more than 0.01% being missing or defective. Hence while these displays may contain pixels that are always lit (white, red, blue, or green) or always off (black), this is not a malfunction and has no effect on images recorded with the device.

Images in the monitor may be difficult to see in a bright light.

Do not apply pressure to the monitor, as this could cause damage or malfunction. Dust or lint on the monitor can be removed with a blower. Stains can be removed by wiping lightly with a soft cloth or chamois leather. Should the monitor break, care should be taken to avoid injury from broken glass and to prevent liquid crystal from the monitor touching the skin or entering the eyes and mouth.

The battery and charger: Batteries may leak or explode if improperly handled. *Read and follow the warnings and cautions on pages xiii–xvi of this manual.* Observe the following precautions when handling batteries:











- Use only batteries approved for use in this equipment.
- Do not expose the battery to flame or excessive heat.
- Keep the battery terminals clean.
- Turn the product off before replacing the battery.
- Remove the battery from the camera or charger when not in use and replace the terminal cover. These devices draw minute amounts of charge even when off and could draw the battery down to the point that it will no longer function. If the battery will not be used for some time, insert it in the camera and run it flat before removing it from the camera for storage. The battery should be stored in a cool location with an ambient temperature of 15 °C to 25 °C (59 °F to 77 °F; avoid hot or extremely cold locations). Repeat this process at least once every six months.
- Turning the camera on or off repeatedly when the battery is fully discharged will shorten battery life. Batteries that have been fully discharged must be charged before use.

- The internal temperature of the battery may rise while the battery is in use. Attempting to charge the battery while the internal temperature is elevated will impair battery performance, and the battery may not charge or charge only partially. Wait for the battery to cool before charging.
- Charge the battery indoors at ambient temperatures of 5 °C–35 °C (41 °F–95 °F). Do not use the battery at ambient temperatures below 0 °C (32 °F) or above 40 °C (104 °F); failure to observe this precaution could damage the battery or impair its performance. Capacity may be reduced and charging times increase at battery temperatures from 0 °C (32 °F) to 15 °C (59 °F) and from 45 °C (113 °F) to 60 °C (140 °F). The battery will not charge if its temperature is below 0 °C (32 °F) or above 60 °C (140 °F).
- If the **CHARGE** lamp flashes quickly (about eight times a second) during charging, confirm that the temperature is in the correct range and then unplug the charger and remove and reinsert the battery. If the problem persists, cease use immediately and take battery and charger to your retailer or a Nikon-authorized service representative.
- Do not move the charger or touch the battery during charging. Failure to observe this precaution could in very rare instances result in the charger showing that charging is complete when the battery is only partially charged. Remove and reinsert the battery to begin charging again. Battery capacity may temporarily drop if the battery is charged at low temperatures or used at a temperature below the temperature at which it was charged. If the battery is charged at a temperature below 5 °C (41 °F), the battery life indicator in the **Battery info** (☐ 383) display may show a temporary decrease.
- Continuing to charge the battery after it is fully charged can impair battery performance.
- A marked drop in the time a fully charged battery retains its charge when used at room temperature indicates that it requires replacement. Purchase a new EN-EL15 battery.
- The supplied power cable and AC wall adapter are for use with the MH-25a only. Use the charger with compatible batteries only. Unplug when not in use.

- Charge the battery before use. When taking photographs on important occasions, ready a spare battery and keep it fully charged. Depending on your location, it may be difficult to purchase replacement batteries on short notice. Note that on cold days, the capacity of batteries tends to decrease. Be sure the battery is fully charged before taking photographs outside in cold weather. Keep a spare battery in a warm place and exchange the two as necessary. Once warmed, a cold battery may recover some of its charge.
- Used batteries are a valuable resource; recycle in accord with local regulations.

Available Settings

The following table lists the settings that can be adjusted in each mode. Note that some settings may be unavailable depending on the options selected.

										
Shooting menus	White balance	—	—	✓	—	—	—	—	—	—
	Set Picture Control	—	—	✓	—	—	—	—	—	—
	Active D-Lighting	— ¹	— ¹	✓	— ¹	— ¹	—	—	—	—
	HDR (high dynamic range)	—	—	✓	—	—	—	—	—	—
	Long exposure NR	✓	✓	✓	✓	✓	—	✓	✓	✓
	High ISO NR	✓	✓	✓	✓	✓	—	✓	✓	✓
	ISO sensitivity settings	✓ ²	✓ ²	✓	✓ ²	✓ ²	—	✓ ²	✓ ²	✓ ²
	Multiple exposure	—	—	✓	—	—	—	—	—	—
	Movie ISO sensitivity settings	—	—	✓	—	—	—	—	—	—
	Time-lapse photography	✓	✓	✓	✓	✓	—	—	—	—
Other settings	Metering	—	—	✓	—	—	—	—	—	—
	Exposure compensation	—	—	✓	✓	✓	✓	—	—	—
	Bracketing	—	—	✓	—	—	—	—	—	—
	Flash mode	✓	—	✓	✓	—	—	✓	—	—
	Flash compensation	—	—	✓	✓	—	—	—	—	—
FV lock	✓	—	✓	✓	—	—	✓	—	—	

			P, S, A, M								
Other settings	Autofocus mode (viewfinder)	✓	✓	✓	✓	✓	✓	—	—	—	✓
	AF-area mode (viewfinder)	✓	✓	✓	✓	✓	—	✓	—	✓	✓
	AF mode (Live view/movie)	✓	✓	✓	✓	✓	✓	—	—	✓	✓
	AF-area mode (Live view/movie)	✓	✓	✓	✓	✓	✓ ³	✓ ³	—	✓ ³	✓
Custom Settings	a9: Built-in AF-assist illuminator	✓	✓	✓	✓ ⁴	✓ ⁵	✓	✓	—	✓	✓
	b3: Easy exposure compensation	—	—	✓	—	—	—	—	—	—	—
	b4: Matrix metering	—	—	✓	—	—	—	—	—	—	—
	b5: Center-weighted area	—	—	✓	—	—	—	—	—	—	—
	d5: Flash warning	—	—	✓	—	—	—	—	—	—	—
	e2: Flash shutter speed	—	—	✓	—	—	—	—	—	—	—
	e3: Flash cntrl for built-in flash/Optional flash	—	—	✓	—	—	—	—	—	—	—
	e4: Exposure comp. for flash	—	—	✓	—	—	—	—	—	—	—
	e5: Modeling flash	—	—	✓	—	—	—	—	—	—	—
	e6: Auto bracketing set	—	—	✓	—	—	—	—	—	—	—
e7: Bracketing order	—	—	✓	—	—	—	—	—	—	—	

1 Fixed at **Auto**.

2 **Auto ISO sensitivity control** is not available.

3 Subject-tracking AF is not available.

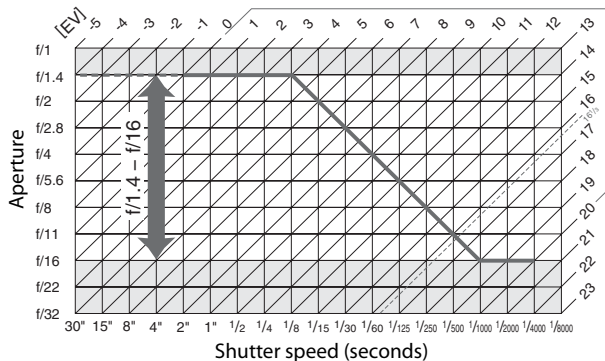
4 Not available in mode.

5 Available only in , , and modes.

Exposure Program (Mode P)

The exposure program for mode **P** is shown in the following graph:

— ISO 100; lens with maximum aperture of f/1.4 and minimum aperture of f/16 (e.g., AF 50mm f/1.4D)



The maximum and minimum values for EV vary with ISO sensitivity; the above graph assumes an ISO sensitivity of ISO 100 equivalent. When matrix metering is used, values over $16\frac{1}{3}$ EV are reduced to $16\frac{1}{3}$ EV.

Troubleshooting

If the camera fails to function as expected, check the list of common problems below before consulting your retailer or Nikon-authorized service representative.

Battery/Display

The camera is on but does not respond: Wait for recording to end. If the problem persists, turn the camera off. If the camera does not turn off, remove and reinsert the battery or, if you are using an AC adapter, disconnect and reconnect the AC adapter. Note that although any data currently being recorded will be lost, data that have already been recorded will not be affected by removing or disconnecting the power source.

Viewfinder is out of focus: Adjust viewfinder focus (☐ 29). If this does not correct the problem, select single-servo autofocus (**AF-S**; ☐ 121), single-point AF (☐ 123), and the center focus point (☐ 127), and then frame a high-contrast subject in the center focus point and press the shutter-release button halfway to focus the camera. With the camera in focus, use the diopter adjustment control to bring the subject into clear focus in the viewfinder. If necessary, viewfinder focus can be further adjusted using optional corrective lenses (☐ 443).

Viewfinder is dark: Insert a fully-charged battery (☐ 25, 30).

Displays turn off without warning: Choose longer delays for Custom Setting c2 (**Standby timer**) or c4 (**Monitor off delay**) (☐ 336, 337).

Control panel and viewfinder displays are unresponsive and dim: The response times and brightness of these displays vary with temperature.

Fine lines are visible around active focus point or display turns red when focus point is highlighted: These phenomena are normal for this type of viewfinder and do not indicate a malfunction.

Shooting (All Modes)

Camera takes time to turn on: Delete files or folders.

Shutter-release disabled:

- Memory card is locked, full, or not inserted (☐ 26, 33).
 - **Release locked** is selected for Custom Setting f7 (**Slot empty release lock**; ☐ 365) and no memory card is inserted (☐ 33).
 - Built-in flash is charging (☐ 40).
 - Camera is not in focus (☐ 36).
 - Aperture ring for CPU lens not locked at highest f-number (does not apply to type G and E lenses). If **F E** is displayed in control panel, select **Aperture ring** for Custom Setting f5 (**Customize command dials**) > **Aperture setting** to use lens aperture ring to adjust aperture (☐ 364).
 - Non-CPU lens is attached but camera is not in mode **A** or **M** (☐ 88).
-

Camera is slow to respond to shutter-release button: Select **Off** for Custom Setting d4 (**Exposure delay mode**; ☐ 339).

No photo taken when remote control shutter-release button is pressed:

- Replace battery in remote control (☐ 444).
 - Choose an option other than **Off** for **Remote control mode (ML-L3)** (☐ 193).
 - Flash is charging (☐ 195).
 - Time selected for Custom Setting c5 (**Remote on duration (ML-L3)**, ☐ 337) has elapsed: press camera shutter-release button halfway.
 - Bright light is interfering with remote.
-

Photos are out of focus:

- Rotate focus-mode selector to **AF** (☐ 120).
 - Camera unable to focus using autofocus: use manual focus or focus lock (☐ 129, 132).
-

Focus does not lock when shutter-release button is pressed halfway: Use ^{AE-L}/_{AF-L} **AE-L/AF-L** button to lock focus when **AF-C** is selected for focus mode or when photographing moving subjects in **AF-A** mode.

Can not select focus point:

- Unlock focus selector lock (☐ 127).
- Auto-area AF or face-priority AF selected for AF-area mode: choose another mode.
- Camera is in playback mode (☐ 241) or menus are in use (☐ 292).
- Press shutter-release button halfway to start standby timer (☐ 39).

Can not select AF mode: Manual focus selected (☐ 60, 132).

Can not select AF-area mode: Manual focus selected (☐ 60, 132).

Only one shot taken each time shutter-release button is pressed in continuous release mode: Continuous shooting is not available if built-in flash fires (☐ 184).

Image size can not be changed: Image quality set to **NEF (RAW)** (☐ 115).

Camera is slow to record photos: Turn long exposure noise reduction off (☐ 317).

Noise (bright spots, randomly-spaced bright pixels, fog, or lines) appear in photos:

- Choose lower ISO sensitivity or use high ISO noise reduction (☐ 134, 317).
- Shutter speed is slower than 1 s: use long exposure noise reduction (☐ 317).
- Turn **Active D-Lighting** off to avoid heightening the effects of noise (☐ 175).

AF-assist illuminator does not light:

- AF-assist illuminator does not light if **AF-C** is selected for autofocus mode (☐ 121) or if continuous-servo autofocus is selected when the camera is in **AF-A** mode. Choose **AF-S**. If an option other than auto-area AF is selected for AF-area mode, select center focus point (☐ 123, 127).
 - The camera is currently in live view or a movie is being recorded.
 - **Off** is selected for Custom Setting a9 (**Built-in AF-assist illuminator**) (☐ 332).
 - Illuminator has turned off automatically. Illuminator may become hot with continued use; wait for it to cool down.
-

Smudges appear in photographs: Clean front and rear lens elements. If problem persists, perform image sensor cleaning (☐ 448).

Sound is not recorded with movies: Microphone off is selected for **Microphone sensitivity** in the movie shooting menu (☐ 320).

Live view ends unexpectedly or does not start: Live view may end automatically to prevent damage to the camera's internal circuits if:

- The ambient temperature is high
- The camera has been used for extended periods in live view or to record movies
- The camera has been used in continuous release modes for extended periods

If live view does not start when you press the **[Lv]** button, wait for the internal circuits to cool and then try again. Note that the camera may feel warm to the touch, but this does not indicate a malfunction.

Image artifacts appear during live view: The temperature of the camera's internal circuits may rise during live view, causing image "noise" in the form of bright spots, randomly-spaced bright pixels, or fog. Exit live view when the camera is not in use.

Flicker or banding appears during live view or movie recording: Choose an option for **Flicker reduction** that matches the frequency of the local AC power supply (☐ 380).

Bright bands appear during live view or movie recording: A flashing sign, flash, or other light source with brief duration was used during live view or movie recording.

Menu item can not be selected: Some options are not available in all modes (☐ 460).

Shooting (P, S, A, M)

Shutter-release disabled:

- Non-CPU lens is attached: rotate camera mode dial to **A** or **M** (□ 88).
 - Mode dial rotated to **S** after shutter speed of **1/4000 s** or **-** selected in mode **M**: choose new shutter speed (□ 90).
-

Full range of shutter speeds not available: Flash in use. Flash sync speed can be selected using Custom Setting e1 (**Flash sync speed**); when using compatible flash units, choose **1/250 s (Auto FP)** or **1/200 s (Auto FP)** for full range of shutter speeds (□ 345).

Colors are unnatural:

- Adjust white balance to match light source (□ 145).
 - Adjust **Set Picture Control** settings (□ 165).
-

Can not measure white balance: Subject is too dark or too bright (□ 158).

Image can not be selected as source for manual preset white balance: Image was not created with D750 (□ 162).

White balance bracketing unavailable:

- NEF (RAW) or NEF+JPEG image quality option selected for image quality (□ 115).
 - Multiple exposure mode is in effect (□ 221).
-

Effects of Picture Control differ from image to image: **A** (auto) is selected for sharpening, clarity, contrast, or saturation. For consistent results over a series of photos, choose another setting (□ 168).

Metering can not be changed: Autoexposure lock is in effect (□ 141).

Exposure compensation can not be used: Camera is in mode **M**. Choose another mode.

Noise (reddish areas or other artifacts) appears in long time-exposures: Enable long exposure noise reduction (□ 317).

Playback

NEF (RAW) image is not played back: Photo was taken at image quality of NEF + JPEG (☞ 115).

Can not view pictures recorded with other cameras: Pictures recorded with other makes of camera may not be displayed correctly.

Message is displayed stating that no images are available for playback: Select **All** for **Playback folder** (☞ 300).

“Tall” (portrait) orientation photos are displayed in “wide” (landscape) orientation:

- Select **On** for **Rotate tall** (☞ 308).
 - Photo was taken with **Off** selected for **Auto image rotation** (☞ 382).
 - Camera was pointed up or down when photo was taken (☞ 382).
 - Photo is displayed in image review (☞ 307).
-

Can not delete picture:

- Picture is protected: remove protection (☞ 257).
 - Memory card is locked (☞ 33).
-

Can not retouch picture: Photo can not be further edited with this camera (☞ 395).

Can not change print order:

- Memory card is full: delete pictures (☞ 38, 258).
 - Memory card is locked (☞ 33).
-

Can not select photo for printing: Photo is in NEF (RAW) format. Transfer photos to computer and print using ViewNX 2 (supplied) or Capture NX-D (available for download; ☞ 268). NEF (RAW) photos can be saved in JPEG format using **NEF (RAW) processing** (☞ 406).

Photo is not displayed on high-definition video device: Confirm that HDMI cable is connected (☞ 277).

Camera does not respond to remote control for HDMI-CEC television:

- Select **On** for **HDMI > Device control** in the setup menu (☞ 278).
 - Adjust HDMI-CEC settings for the television as described in documentation provided with the device.
-

Can not transfer photos to computer: OS not compatible with camera or transfer software. Use card reader to copy photos to computer (☐ 264).

Image Dust Off option in Capture NX-D does not have desired effect: Image sensor cleaning changes the position of dust on the low-pass filter. Dust off reference data recorded before image sensor cleaning is performed can not be used with photographs taken after image sensor cleaning is performed. Dust off reference data recorded after image sensor cleaning is performed can not be used with photographs taken before image sensor cleaning is performed (☐ 380).

Computer displays NEF (RAW) images differently from camera: Third-party software does not display effects of Picture Controls, Active D-Lighting, or vignette control. Use ViewNX 2 (supplied) or Nikon software such as Capture NX-D (available for download; ☐ 268).

Wi-Fi (Wireless Networks)

Smart devices do not display the camera SSID (network name):

- Confirm that **Enable** is selected for **Wi-Fi > Network connection** in the camera setup menu (☐ 284).
 - Try turning the smart device Wi-Fi off and then on again.
-





Miscellaneous

Date of recording is not correct: Set camera clock (☐ 28, 381).



Menu item can not be selected: Some options are not available at certain combinations of settings or when no memory card is inserted. Note that **Battery info** option is not available when camera is powered by an optional power connector and AC adapter (☐ 383).





Error Messages

This section lists the indicators and error messages that appear in the viewfinder, control panel, and monitor.

Indicator		Problem	Solution	📖
Control panel	View-finder			
FE E (flashes)		Lens aperture ring is not set to minimum aperture.	Set ring to minimum aperture (highest f-number).	33
		Low battery.	Ready a fully-charged spare battery.	25
 (flashes)	 (flashes)	<ul style="list-style-type: none"> • Battery exhausted. • Battery can not be used. • An extremely exhausted rechargeable Li-ion battery or a third-party battery is inserted either in the camera or in the optional MB-D16 battery pack. 	<ul style="list-style-type: none"> • Recharge or replace battery. • Contact Nikon-authorized service representative. • Replace the battery, or recharge the battery if the rechargeable Li-ion battery is exhausted. 	xxii, 25, 26
ΔF		No lens attached, or non-CPU lens attached without specifying maximum aperture. Aperture shown in stops from maximum aperture.	Aperture value will be displayed if maximum aperture is specified.	235


Indicator		Problem	Solution	📖
Control panel	Viewfinder			
F - - (flashes)		• No lens attached.	• Attach non-IX Nikkor lens. If a CPU lens is attached, remove and reattach the lens.	27, 426
		• Non-CPU lens attached.	• Select mode A or M .	88
—	▶ ◀ (flashes)	Camera unable to focus using autofocus.	Change composition or focus manually.	131, 132
(Exposure indicators and shutter speed or aperture display flash)		Subject too bright; photo will be overexposed.	• Use a lower ISO sensitivity	134
			• In shooting mode: P Use optional ND filter	442
			S Increase shutter speed	90
			A Choose a smaller aperture (higher f-number)	91
			☑ Choose another shooting mode	6
		Subject too dark; photo will be underexposed.	• Use a higher ISO sensitivity	134
			• In shooting mode: P Use flash	180
			S Lower shutter speed	90
			A Choose a larger aperture (lower f-number)	91

Indicator		Problem	Solution	
Control panel	View-finder			
b u l b (flashes)		b u l b selected in mode S .	Change shutter speed or select mode M .	90, 93
- - (flashes)		- - selected in mode S .	Change shutter speed or select mode M .	90, 93
b u s y (flashes)	b s y (flashes)	Processing in progress.	Wait until processing is complete.	—
—	 (flashes)	If indicator flashes for 3s after flash fires, photo may be underexposed.	Check photo in monitor; if underexposed, adjust settings and try again.	241
F u l l (flashes)	F u l (flashes)	Memory insufficient to record further photos at current settings, or camera has run out of file or folder numbers.	<ul style="list-style-type: none"> • Reduce quality or size. • Delete photographs after copying important images to computer or other device. • Insert new memory card. 	115, 118, 258 26
E r r (flashes)		Camera malfunction.	Release shutter. If error persists or appears frequently, consult Nikon-authorized service representative.	—

Indicator		Problem	Solution	
Monitor	Control panel			
No memory card.	(- E -)	Camera cannot detect memory card.	Turn camera off and confirm that card is correctly inserted.	26
This memory card cannot be used. Card may be damaged. Insert another card.	 (flashes)	<ul style="list-style-type: none"> • Error accessing memory card. 	<ul style="list-style-type: none"> • Use Nikon-approved card. • Check that contacts are clean. If card is damaged, contact retailer or Nikon-authorized service representative. 	491 —
		<ul style="list-style-type: none"> • Unable to create new folder. 	<ul style="list-style-type: none"> • Delete files or insert new memory card after copying important images to computer or other device. 	26, 258
	 (flashes)	Camera can not control Eye-Fi card.	<ul style="list-style-type: none"> • Check that Eye-Fi card firmware is up to date. • Copy files on Eye-Fi card to a computer or other device and format card, or insert new card. 	391 26, 266, 375

Indicator		Problem	Solution	📖
Monitor	Control panel			
Memory card is locked. Slide lock to “write” position.	⏏ (flashes)	Memory card is locked (write protected).	Slide card write-protect switch to “write” position.	33
Not available if Eye-Fi card is locked.	⏏ (flashes)	Eye-Fi card is locked (write protected).		
This card is not formatted. Format the card.	[F ⏏] (flashes)	Memory card has not been formatted for use in camera.	Format memory card or insert new memory card.	26, 375
Clock has been reset.	—	Camera clock is not set.	Set camera clock.	28, 381
Unable to start live view. Please wait.	—	The internal temperature of the camera is high.	Wait for the internal circuits to cool before resuming live view or movie recording.	466
Folder contains no images.	—	No images on memory card or in folder(s) selected for playback.	Select folder containing images from Playback folder menu or insert memory card containing images.	26, 300
All images are hidden.	—	All photos in current folder are hidden.	No images can be played back until another folder has been selected or Hide image used to allow at least one image to be displayed.	301

Indicator		Problem	Solution	📖
Monitor	Control panel			
Cannot display this file.	—	File has been created or modified using a computer or different make of camera, or file is corrupt.	File can not be played back on camera.	—
Cannot select this file.	—	Selected image can not be retouched.	Images created with other devices can not be retouched.	395
This movie cannot be edited.	—	The selected movie can not be edited.	<ul style="list-style-type: none"> • Movies created with other devices can not be edited. • Movies must be at least two seconds long. 	85
Could not connect; multiple devices detected. Try again later.	—	Multiple smart devices are attempting to connect to camera simultaneously.	Wait a few minutes before trying again.	282
Error	—	Wi-Fi error.	Select Disable for Wi-Fi > Network connection , then select Enable again.	288

Indicator		Problem	Solution	
Monitor	Control panel			
Network access not available until camera cools.	—	The internal temperature of the camera is high.	Turn camera off and try again after waiting for camera to cool.	—
Check printer.	—	Printer error.	Check printer. To resume, select Continue (if available).	271*
Check paper.	—	Paper in printer is not of selected size.	Insert paper of correct size and select Continue .	271*
Paper jam.	—	Paper is jammed in printer.	Clear jam and select Continue .	271*
Out of paper.	—	Printer is out of paper.	Insert paper of selected size and select Continue .	271*
Check ink supply.	—	Ink error.	Check ink. To resume, select Continue .	271*
Out of ink.	—	Printer is out of ink.	Replace ink and select Continue .	271*

* See printer manual for more information.

Specifications


■ Nikon D750 Digital Camera


Type	
Type	Single-lens reflex digital camera
Lens mount	Nikon F mount (with AF coupling and AF contacts)
Effective angle of view	Nikon FX format
Effective pixels	
Effective pixels	24.3 million
Image sensor	
Image sensor	35.9 × 24.0 mm CMOS sensor
Total pixels	24.93 million
Dust-reduction System	Image sensor cleaning, Image Dust Off reference data (Capture NX-D software required)
Storage	
Image size (pixels)	<ul style="list-style-type: none">• FX (36×24) image area 6016 × 4016 (L) 4512 × 3008 (M) 3008 × 2008 (S)• 1.2× (30×20) image area 5008 × 3336 (L) 3752 × 2504 (M) 2504 × 1664 (S)• DX (24×16) image area 3936 × 2624 (L) 2944 × 1968 (M) 1968 × 1312 (S)• FX-format photographs taken in movie live view 6016 × 3376 (L) 4512 × 2528 (M) 3008 × 1688 (S)• DX-format photographs taken in movie live view 3936 × 2224 (L) 2944 × 1664 (M) 1968 × 1112 (S) <p>Note: Photographs taken in movie live view have an aspect ratio of 16 : 9. The camera offers a choice of DX- and FX-based formats.</p>

Storage	
File format	<ul style="list-style-type: none"> • NEF (RAW): 12 or 14 bit, lossless compressed or compressed • JPEG: JPEG-Baseline compliant with fine (approx. 1 : 4), normal (approx. 1 : 8), or basic (approx. 1 : 16) compression (Size priority); Optimal quality compression available • NEF (RAW)+JPEG: Single photograph recorded in both NEF (RAW) and JPEG formats
Picture Control System	Standard, Neutral, Vivid, Monochrome, Portrait, Landscape, Flat; selected Picture Control can be modified; storage for custom Picture Controls
Media	SD (Secure Digital) and UHS-I compliant SDHC and SDXC memory cards
Double slot	Slot 2 can be used for overflow or backup storage or for separate storage of copies created using NEF+JPEG; pictures can be copied between cards.
File system	DCF 2.0, DPOF, Exif 2.3, PictBridge
Viewfinder	
Viewfinder	Eye-level pentaprism single-lens reflex viewfinder
Frame coverage	<ul style="list-style-type: none"> • FX (36×24): Approx. 100% horizontal and 100% vertical • 1.2× (30×20): Approx. 97% horizontal and 97% vertical • DX (24×16): Approx. 97% horizontal and 97% vertical
Magnification	Approx. $0.7 \times$ (50 mm f/1.4 lens at infinity, -1.0 m^{-1})
Eyepoint	21 mm (-1.0 m^{-1} ; from center surface of viewfinder eyepiece lens)
Diopter adjustment	$-3 - +1 \text{ m}^{-1}$

Viewfinder	
Focusing screen	Type B BriteView Clear Matte Mark III screen with AF area brackets (framing grid can be displayed)
Reflex mirror	Quick return
Depth-of-field preview	Pressing Pv button stops lens aperture down to value selected by user (A and M modes) or by camera (other modes)
Lens aperture	Instant return, electronically controlled
Lens	
Compatible lenses	<p>Compatible with AF NIKKOR lenses, including type G, E, and D lenses (some restrictions apply to PC lenses) and DX lenses (using DX 24 × 16 1.5× image area), AI-P NIKKOR lenses, and non-CPU AI lenses (A and M modes only). IX NIKKOR lenses, lenses for the F3AF, and non-AI lenses can not be used.</p> <p>The electronic rangefinder can be used with lenses that have a maximum aperture of f/5.6 or faster (the electronic rangefinder supports the 11 focus points with lenses that have a maximum aperture of f/8 or faster).</p>
Shutter	
Type	Electronically-controlled vertical-travel focal-plane shutter
Speed	$\frac{1}{4000}$ – 30 s in steps of $\frac{1}{3}$ or $\frac{1}{2}$ EV, bulb, time, X200
Flash sync speed	X = $\frac{1}{200}$ s; synchronizes with shutter at $\frac{1}{250}$ s or slower (flash range drops at speeds between $\frac{1}{200}$ and $\frac{1}{250}$ s)

Release	
Release mode	S (single frame), CL (continuous low speed), CH (continuous high speed), Q (quiet shutter-release), Qc (quiet continuous shutter-release), ⌚ (self-timer), Mup (mirror up)
Frame advance rate	1–6 fps (CL), 6.5 fps (CH), or 3 fps (Qc)
Self-timer	2 s, 5 s, 10 s, 20 s; 1–9 exposures at intervals of 0.5, 1, 2, or 3 s
Remote control modes (ML-L3)	Delayed remote, quick-response remote, remote mirror-up
Exposure	
Metering	TTL exposure metering using RGB sensor with approximately 91K (91,000) pixels
Metering method	<ul style="list-style-type: none"> • Matrix: 3D color matrix metering III (type G, E, and D lenses); color matrix metering III (other CPU lenses); color matrix metering available with non-CPU lenses if user provides lens data • Center-weighted: Weight of approximately 75% given to 12 mm circle in center of frame. Diameter of circle can be changed to 8, 15, or 20 mm, or weighting can be based on average of entire frame (non-CPU lenses use 12-mm circle) • Spot: Meters 4 mm circle (about 1.5% of frame) centered on selected focus point (on center focus point when non-CPU lens is used) • Highlight-weighted: Available with type G, E, and D lenses; equivalent to center-weighted when other lenses are used.
Range (ISO 100, f/1.4 lens, 20 °C/68 °F)	<ul style="list-style-type: none"> • Matrix, center-weighted, or highlight-weighted metering: 0–20 EV • Spot metering: 2–20 EV
Exposure meter coupling	Combined CPU and AI

Exposure	
Mode	Auto modes (📷 auto; 📷 auto (flash off)); scene modes (👤 portrait; 🏞️ landscape; 👶 child; 🏀 sports; 🌸 close up; 🌃 night portrait; 🌃 night landscape; 🎉 party/indoor; 🏖️ beach/snow; 🌅 sunset; 🌅 dusk/dawn; 🐾 pet portrait; 🕯️ candlelight; 🌸 blossom; 🍂 autumn colors; 🍽️ food); special effects modes (🌃 night vision; 🎨 color sketch; 🏠 miniature effect; 🎨 selective color; 🖋️ silhouette; 📷 high key; 📷 low key); programmed auto with flexible program (P); shutter-priority auto (S); aperture-priority auto (A); manual (M); U1 (user settings 1); U2 (user settings 2)
Exposure compensation	Can be adjusted by -5 – +5 EV in increments of 1/3 or 1/2 EV in P, S, A, M, SCENE, and 📷 modes
Exposure bracketing	2–9 frames in steps of 1/3, 1/2, 2/3, or 1 EV; 2–5 frames in steps of 2 or 3 EV
Flash bracketing	2–9 frames in steps of 1/3, 1/2, 2/3, or 1 EV; 2–5 frames in steps of 2 or 3 EV
White balance bracketing	2–3 frames in steps of 1, 2, or 3
ADL bracketing	2 frames using selected value for one frame or 3–5 frames using preset values for all frames
Exposure lock	Luminosity locked at detected value with  AE-L/AF-L button
ISO sensitivity (Recommended Exposure Index)	ISO 100 – 12800 in steps of 1/3 or 1/2 EV. Can also be set to approx. 0.3, 0.5, 0.7, or 1 EV (ISO 50 equivalent) below ISO 100 or to approx. 0.3, 0.5, 0.7, 1, or 2 EV (ISO 51200 equivalent) above ISO 12800; auto ISO sensitivity control available
Active D-Lighting	Auto, Extra high, High, Normal, Low, Off

Focus	
Autofocus	Nikon Advanced Multi-CAM 3500 II autofocus sensor module with TTL phase detection, fine-tuning, 51 focus points (including 15 cross-type sensors; f/8 supported by 11 sensors), and AF-assist illuminator (range approx. 0.5–3 m/1 ft 8 in.–9 ft 10 in.)
Detection range	–3 – +19 EV (ISO 100, 20 °C/68 °F)
Lens servo	<ul style="list-style-type: none"> • Autofocus (AF): Single-servo AF (AF-S); continuous-servo AF (AF-C); auto AF-S/AF-C selection (AF-A); predictive focus tracking activated automatically according to subject status • Manual focus (M): Electronic rangefinder can be used
Focus point	Can be selected from 51 or 11 focus points
AF-area mode	Single-point AF; 9-, 21-, or 51-point dynamic-area AF, 3D-tracking, group-area AF, auto-area AF
Focus lock	Focus can be locked by pressing shutter-release button halfway (single-servo AF) or by pressing <small>AE-L</small> AE-L/AF-L button
Flash	
Built-in flash	 : Auto flash with auto pop-up P, S, A, M, 11 : Manual pop-up with button release
Guide Number	Approx. 12/39, 12/39 with manual flash (m/ft, ISO 100, 20 °C/68 °F)

Flash	
Flash control	TTL: i-TTL flash control using RGB sensor with approximately 91K (91,000) pixels is available with built-in flash; i-TTL balanced fill-flash for digital SLR is used with matrix, center-weighted, and highlight-weighted metering, standard i-TTL flash for digital SLR with spot metering
Flash mode	Auto, auto with red-eye reduction, auto slow sync, auto slow sync with red-eye reduction, fill-flash, red-eye reduction, slow sync, slow sync with red-eye reduction, rear-curtain with slow sync, rear-curtain sync, off; Auto FP High-Speed Sync supported
Flash compensation	-3 – +1 EV in increments of $\frac{1}{3}$ or $\frac{1}{2}$ EV
Flash-ready indicator	Lights when built-in flash or optional flash unit is fully charged; blinks after flash is fired at full output
Accessory shoe	ISO 518 hot-shoe with sync and data contacts and safety lock
Nikon Creative Lighting System (CLS)	Nikon CLS supported; commander mode option available
Sync terminal	AS-15 sync terminal adapter (available separately)
White balance	
White balance	Auto (2 types), incandescent, fluorescent (7 types), direct sunlight, flash, cloudy, shade, preset manual (up to 6 values can be stored, spot white balance measurement available during live view), choose color temperature (2500 K–10000 K), all with fine-tuning

Live view	
Modes	Live view photography (still images), movie live view (movies)
Lens servo	<ul style="list-style-type: none"> • Autofocus (AF): Single-servo AF (AF-S); full-time servo AF (AF-F) • Manual focus (M)
AF-area mode	Face-priority AF, wide-area AF, normal-area AF, subject-tracking AF
Autofocus	Contrast-detect AF anywhere in frame (camera selects focus point automatically when face-priority AF or subject-tracking AF is selected)
Movie	
Metering	TTL exposure metering using main image sensor
Metering method	Matrix, center-weighted, or highlight-weighted
Frame size (pixels) and frame rate	<ul style="list-style-type: none"> • 1920 × 1080; 60 p (progressive), 50 p, 30 p, 25 p, 24 p • 1280 × 720; 60 p, 50 p <p>Actual frame rates for 60 p, 50 p, 30 p, 25 p, and 24 p are 59.94, 50, 29.97, 25, and 23.976 fps respectively; options support both ★high and normal image quality</p>
File format	MOV
Video compression	H.264/MPEG-4 Advanced Video Coding
Audio recording format	Linear PCM
Audio recording device	Built-in or external stereo microphone; sensitivity adjustable
Other options	Index marking, time-lapse photography
Monitor	
Monitor	8-cm/3.2-in., approx. 1229 k-dot (VGA; 640 × RGBW × 480 = 1,228,800 dots), low-temperature polysilicon tilting TFT LCD with approx. 170° viewing angle, approx. 100% frame coverage, and brightness and angle adjustment

Playback	
Playback	Full-frame and thumbnail (4, 9, or 72 images or calendar) playback with playback zoom, movie playback, photo and/or movie slide shows, histogram display, highlights, photo information, location data display, and auto image rotation
Interface	
USB	Hi-Speed USB; connection to built-in USB port is recommended
HDMI output	Type C HDMI connector
Accessory terminal	<ul style="list-style-type: none"> • Wireless remote controllers: WR-1, WR-R10 (available separately) • Remote cord: MC-DC2 (available separately) • GPS unit: GP-1/GP-1A (available separately)
Audio input	Stereo mini-pin jack (3.5 mm diameter; plug-in power supported)
Audio output	Stereo mini-pin jack (3.5 mm diameter)
Wireless (D750 only; not available with the D750 (K))	
Standards	IEEE 802.11b, IEEE 802.11g
Communications protocols	<ul style="list-style-type: none"> • IEEE 802.11b: DSSS/CCK • IEEE 802.11g: OFDM
Operating frequency	2412–2462 MHz (channels 1–11)
Range (line of sight)	Approximately 30 m/98 ft (assumes no interference; range may vary with signal strength and presence or absence of obstacles)
Data rate	54 Mbps Maximum logical data rates according to IEEE standard. Actual rates may differ.
Security	<ul style="list-style-type: none"> • Authentication: Open system, WPA2-PSK • Encryption: AES
Wireless setup	Supports WPS
Access protocols	Infrastructure

Supported languages	
Supported languages	Arabic, Bengali, Bulgarian, Chinese (Simplified and Traditional), Czech, Danish, Dutch, English, Finnish, French, German, Greek, Hindi, Hungarian, Indonesian, Italian, Japanese, Korean, Marathi, Norwegian, Persian, Polish, Portuguese (Portugal and Brazil), Romanian, Russian, Serbian, Spanish, Swedish, Tamil, Telugu, Thai, Turkish, Ukrainian, Vietnamese

Power source	
Battery	One EN-EL15 rechargeable Li-ion battery
Battery pack	Optional MB-D16 multi-power battery pack with one Nikon EN-EL15 rechargeable Li-ion battery or six AA alkaline, Ni-MH, or lithium batteries
AC adapter	EH-5b AC adapter; requires EP-5B power connector (available separately)

Tripod socket	
Tripod socket	1/4 in. (ISO 1222)

Dimensions/weight	
Dimensions (W × H × D)	Approx. 140.5 × 113 × 78 mm (5.6 × 4.5 × 3.1 in.)
Weight	Approx. 840 g (1 lb 13.7 oz) with battery and memory card but without body cap; approx. 750 g (1 lb 10.5 oz; camera body only)

Operating environment	
Temperature	0 °C–40 °C (+32 °F–104 °F)
Humidity	85% or less (no condensation)

- Unless otherwise stated, all figures are for a camera with a fully-charged battery operating at the temperature specified by the Camera and Imaging Products Association (CIPA): 23 ±3 °C (73.4 ±5.4 °F).
- Nikon reserves the right to change the specifications of the hardware and software described in this manual at any time and without prior notice. Nikon will not be held liable for damages that may result from any mistakes that this manual may contain.

MH-25a Battery Charger	
Rated input (in North America)	AC 120 V, 60 Hz, 0.2 A
Rated input (in other regions)	AC 100–240 V, 50/60 Hz, 0.23–0.12 A
Rated output	DC 8.4 V/1.2 A
Supported batteries	Nikon EN-EL15 rechargeable Li-ion batteries
Charging time	Approx. 2 hours and 35 minutes at an ambient temperature of 25 °C (77 °F) when no charge remains
Operating temperature	0 °C–40 °C (+32 °F–104 °F)
Dimensions (W × H × D)	Approx. 95 × 33.5 × 71 mm (3.7 × 1.3 × 2.8 in.), excluding projections
Length of power cable (if supplied)	Approx. 1.5 m (4.9 ft)
Weight	Approx. 115 g (4.1 oz), excluding supplied power connector (power cable or AC wall adapter)

EN-EL15 Rechargeable Li-ion Battery	
Type	Rechargeable lithium-ion battery
Rated capacity	7.0 V/1900 mAh
Operating temperature	0 °C–40 °C (+32 °F–104 °F)
Dimensions (W × H × D)	Approx. 40 × 56 × 20.5 mm (1.6 × 2.2 × 0.8 in.)
Weight	Approx. 88 g (3.1 oz), excluding terminal cover

- Nikon reserves the right to change the specifications of the hardware and software described in this manual at any time and without prior notice. Nikon will not be held liable for damages that may result from any mistakes that this manual may contain.

■ ■ *Supported Standards*

- **DCF Version 2.0:** The Design Rule for Camera File Systems (DCF) is a standard widely used in the digital camera industry to ensure compatibility among different makes of camera.
- **DPOF:** Digital Print Order Format (DPOF) is an industry-wide standard that allows pictures to be printed from print orders stored on the memory card.
- **Exif version 2.3:** The camera supports Exif (Exchangeable Image File Format for Digital Still Cameras) version 2.3, a standard in which information stored with photographs is used for optimal color reproduction when the images are output on Exif-compliant printers.
- **PictBridge:** A standard developed through cooperation with the digital camera and printer industries, allowing photographs to be output directly to a printer without first transferring them to a computer.
- **HDMI:** High-Definition Multimedia Interface is a standard for multimedia interfaces used in consumer electronics and AV devices capable of transmitting audiovisual data and control signals to HDMI-compliant devices via a single cable connection.

Trademark Information

IOS is a trademark or registered trademark of Cisco Systems, Inc., in the United States and/or other countries and is used under license. Mac and OS X are registered trademarks of Apple Inc. in the United States and/or other countries. Microsoft, Windows, and Windows Vista are either registered trademarks, or trademarks of Microsoft Corporation in the United States and/or other countries. PictBridge is a trademark. The SD, SDHC, and SDXC logos are trademarks of the SD-3C, LLC. HDMI, the HDMI logo and High-Definition Multimedia Interface are trademarks or registered trademarks of HDMI Licensing, LLC.

HDMI

Wi-Fi and the Wi-Fi logo are trademarks or registered trademarks of the Wi-Fi Alliance. All other trade names mentioned in this manual or the other documentation provided with your Nikon product are trademarks or registered trademarks of their respective holders.

Conformity Marking

The standards with which the camera complies can be viewed using the **Conformity marking** option in the setup menu (□ 392).

FreeType License (FreeType2)

Portions of this software are copyright © 2012 The FreeType Project (<http://www.freetype.org>). All rights reserved.

MIT License (HarfBuzz)

Portions of this software are copyright © 2014 The HarfBuzz Project (<http://www.freedesktop.org/wiki/Software/HarfBuzz>). All rights reserved.

Certificates

• Indonesia

35157/SDPPI/2014
4593

35158/SDPPI/2014
4588

• México

COFETEL: RCPMULB13-0954
LBWA1U5YR1

• Paraguay

Número del Registro: 2014-01-I-00028

Este producto contiene un transmisor
aprobado por la CONATEL.

• Brasil



(01)0789857980 048 9

• الأردن

TRC/LPD/2013/141

• عُمان

OMAN-TRA

R/1307/13

D100428

• الإمارات العربية المتحدة

TRA

REGISTERED No:

ER0112542/13

DEALER No:

DA0073692/11

Approved Memory Cards

The following SD memory cards have been tested and approved for use in the camera. Cards with class 6 or faster write speeds are recommended for movie recording. Recording may end unexpectedly when cards with slower write speeds are used.

	SD cards	SDHC cards ²	SDXC cards ³
SanDisk	2 GB ¹	4 GB, 8 GB, 16 GB, 32 GB	64 GB, 128 GB
Toshiba	—		64 GB
Panasonic	2 GB ¹	4 GB, 6 GB, 8 GB, 12 GB, 16 GB, 24 GB, 32 GB	48 GB, 64 GB
Lexar Media		4 GB, 8 GB, 16 GB, 32 GB	—
Platinum II	—	8 GB, 16 GB, 32 GB	64 GB
Professional			64 GB, 128 GB, 256 GB
Full-HD Video		4 GB, 8 GB, 16 GB	—

- 1 Check that any card readers or other devices with which the card will be used support 2 GB cards.
- 2 Check that any card readers or other devices with which the card will be used are SDHC-compliant. The camera supports UHS-1.
- 3 Check that any card readers or other devices with which the card will be used are SDXC-compliant. The camera supports UHS-1.



Other cards have not been tested. For more details on the above cards, please contact the manufacturer.

Memory Card Capacity

The following table shows the approximate number of pictures that can be stored on a 16 GB SanDisk SDSDXPA-016G-J35 UHS-I SDHC card at different image quality (☐ 115), image size (☐ 118), and image area settings (☐ 110).

■ FX (36×24) Image Area *

Image quality	Image size	File size ¹	No. of images ¹	Buffer capacity ²
NEF (RAW), Lossless compressed, 12-bit	—	21.0 MB	376	25
NEF (RAW), Lossless compressed, 14-bit	—	26.9 MB	292	15
NEF (RAW), Compressed, 12-bit	—	19.2 MB	507	33
NEF (RAW), Compressed, 14-bit	—	23.9 MB	425	21
JPEG fine ³	Large	12.6 MB	923	87
	Medium	7.7 MB	1500	100
	Small	4.1 MB	2900	100
JPEG normal ³	Large	6.7 MB	1800	100
	Medium	3.9 MB	2900	100
	Small	2.1 MB	5500	100
JPEG basic ³	Large	2.2 MB	3500	100
	Medium	1.6 MB	5700	100
	Small	1.1 MB	10100	100

* Includes images taken with non-DX lenses when **On** is selected for **Auto DX crop**.

■ ■ DX (24×16) Image Area*

Image quality	Image size	File size ¹	No. of images ¹	Buffer capacity ²
NEF (RAW), Lossless compressed, 12-bit	—	10.5 MB	579	100
NEF (RAW), Lossless compressed, 14-bit	—	13.1 MB	449	48
NEF (RAW), Compressed, 12-bit	—	9.8 MB	785	100
NEF (RAW), Compressed, 14-bit	—	11.9 MB	656	100
JPEG fine ³	Large	6.2 MB	1900	100
	Medium	3.9 MB	3000	100
	Small	2.3 MB	5000	100
JPEG normal ³	Large	3.1 MB	3700	100
	Medium	2.0 MB	5700	100
	Small	1.2 MB	9300	100
JPEG basic ³	Large	1.6 MB	7000	100
	Medium	1.2 MB	10300	100
	Small	0.8 MB	15600	100

* Includes images taken with DX lenses when **On** is selected for **Auto DX crop**.

- 1 All figures are approximate. File size varies with scene recorded.
- 2 Maximum number of exposures that can be stored in memory buffer at ISO 100. Drops if **Optimal quality** is selected for **JPEG compression** (□ 117), ISO sensitivity is set to Hi 0.3 or higher, or long exposure noise reduction or auto distortion control is on.
- 3 Figures assume **JPEG compression** is set to **Size priority**. Selecting **Optimal quality** increases the file size of JPEG images; number of images and buffer capacity drop accordingly.

📷 d3—Max. Continuous Release (□ 339)

The maximum number of photographs that can be taken in a single burst can be set to any amount between 1 and 100.

Battery Life

The movie footage or number of shots that can be recorded with fully-charged batteries varies with the condition of the battery, temperature, interval between shots, and the length of time menus are displayed. In the case of AA batteries, capacity also varies with make and storage conditions; some batteries can not be used. Sample figures for the camera and optional MB-D16 multi-power battery pack are given below.

- **Photographs, single-frame release mode (CIPA standard ¹)**
 - One EN-EL15 battery (camera):** Approximately 1230 shots
 - One EN-EL15 battery (MB-D16):** Approximately 1230 shots
 - Six AA alkaline batteries (MB-D16):** Approximately 430 shots
- **Photographs, continuous release mode (Nikon standard ²)**
 - One EN-EL15 battery (camera):** Approximately 4420 shots
 - One EN-EL15 battery (MB-D16):** Approximately 4420 shots
 - Six AA alkaline batteries (MB-D16):** Approximately 780 shots
- **Movies ³**
 - One EN-EL15 battery (camera):** Approximately 55 minutes of HD footage
 - One EN-EL15 battery (MB-D16):** Approximately 55 minutes of HD footage
 - Six AA alkaline batteries (MB-D16):** Approximately 20 minutes of HD footage

- 1 Measured at 23 °C/73.4 °F (± 2 °C/3.6 °F) with an AF-S NIKKOR 24–85mm f/3.5–4.5G ED VR lens under the following test conditions: lens cycled from infinity to minimum range and one photograph taken at default settings once every 30 s; flash fired once every other shot. Live view not used.
- 2 Measured at 20 °C/68 °F with an AF-S NIKKOR 24–85mm f/3.5–4.5G ED VR lens under the following test conditions: image quality set to JPEG basic, image size set to **M** (medium), shutter speed $\frac{1}{250}$ s, shutter-release button pressed halfway for three seconds and focus cycled from infinity to minimum range three times; six shots are then taken in succession and monitor turned on for five seconds and then turned off; cycle repeated once standby timer expires.
- 3 Measured at 23 °C/73.4 °F (± 3 °C/5.4 °F) with the camera at default settings and an AF-S NIKKOR 24–85mm f/3.5–4.5G ED VR lens under conditions specified by the Camera and Imaging Products Association (CIPA). Individual movies can be up to 20 minutes (1080/60p) in length or 4 GB in size; recording may end before these limits are reached if the camera temperature rises.

The following can reduce battery life:

- Using the monitor
- Keeping the shutter-release button pressed halfway
- Repeated autofocus operations
- Taking NEF (RAW) photographs
- Slow shutter speeds
- Using an optional GP-1 or GP-1A GPS unit or WR-R10/WR-1 wireless remote controller
- Using Wi-Fi or an optional UT-1 communication unit or WT-5 wireless transmitter
- Using VR (vibration reduction) mode with VR lenses

To ensure that you get the most from Nikon EN-EL15 rechargeable Li-ion batteries:

- Keep the battery contacts clean. Soiled contacts can reduce battery performance.
- Use batteries immediately after charging. Batteries will lose their charge if left unused.

Lenses That May Block the Built-in Flash and AF-Assist Illuminator

The lenses listed in this section may block the built-in flash or AF-assist illuminator under some conditions.

■ *AF-Assist Illumination*

Some lenses may block the illuminator at certain focus distances. Remove lens hoods when using the illuminator.

AF-assist illumination is not available with the following lenses:

- AF-S NIKKOR 200mm f/2G ED VR II
- AF-S VR Zoom-Nikkor 200–400mm f/4G IF-ED
- AF-S NIKKOR 200–400mm f/4G ED VR II
- AF-S NIKKOR 300mm f/2.8G ED VR II

At ranges under 0.7 m (2 ft 4 in.), the following lenses may block the AF-assist illuminator and interfere with autofocus when lighting is poor:

- AF-S NIKKOR 16–35mm f/4G ED VR
- AF-S Zoom-Nikkor 17–35mm f/2.8D IF-ED
- AF-S DX Zoom-Nikkor 17–55mm f/2.8G IF-ED
- AF-S DX VR Zoom-Nikkor 18–200mm f/3.5–5.6G IF-ED
- AF Zoom-Nikkor 20–35mm f/2.8D IF
- AF Zoom-Nikkor 24–85mm f/2.8–4D IF
- AF-S NIKKOR 24–85mm f/3.5–4.5G ED VR
- AF Zoom Nikkor 24–120mm f/3.5–5.6D (IF)
- AF-S NIKKOR 24–120mm f/4G ED VR
- AF-S NIKKOR 28–300mm f/3.5–5.6G ED VR
- AF-S NIKKOR 35mm f/1.4G
- AF Zoom Micro Nikkor ED 70–180mm f/4.5–5.6D
- AF-S VR Micro-Nikkor 105mm f/2.8G IF-ED

At ranges under 1.0 m (3 ft 3 in.), the following lenses may block the AF-assist illuminator and interfere with autofocus when lighting is poor:

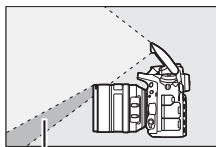
- AF-S DX NIKKOR 18–200mm f/3.5–5.6G ED VR II
- AF-S DX NIKKOR 18–300mm f/3.5–5.6G ED VR
- AF-S DX NIKKOR 18–300mm f/3.5–6.3G ED VR
- AF-S NIKKOR 24–70mm f/2.8G ED
- AF-S VR Zoom-Nikkor 24–120mm f/3.5–5.6G IF-ED
- AF-S Zoom-Nikkor 28–70mm f/2.8D IF-ED
- AF-S NIKKOR 28–300mm f/3.5–5.6G ED VR
- AF Micro-Nikkor 200mm f/4D IF-ED

At ranges under 1.5 m (4 ft 11 in.), the following lenses may block the AF-assist illuminator and interfere with autofocus when lighting is poor:

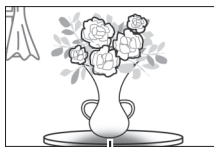
- AF-S NIKKOR 14–24mm f/2.8G ED
- AF-S DX NIKKOR 18–300mm f/3.5–5.6G ED VR
- AF-S DX NIKKOR 55–300mm f/4.5–5.6G ED VR
- AF-S VR Zoom-Nikkor 70–200mm f/2.8G IF-ED
- AF-S NIKKOR 70–200mm f/2.8G ED VR II
- AF Zoom-Nikkor 80–200mm f/2.8D ED
- AF-S Zoom-Nikkor 80–200mm f/2.8D IF-ED

■ The Built-in Flash

The built-in flash has a minimum range of 0.6 m (2 ft) and can not be used in the macro range of macro zoom lenses. It can be used with CPU lenses with focal lengths of 24 mm (16 mm in DX format) to 300 mm, although in some cases the flash may be unable to entirely light the subject at some ranges or focal lengths due to shadows cast by the lens. The following illustrations show the effect of vignetting caused by shadows cast by the lens when the flash is used.



Shadow



Vignetting

Remove lens hoods to prevent shadows. The flash may be unable to light the entire subject with the following lenses at ranges less than those given below:

	Lens	Zoom position	Minimum distance without vignetting
XD	AF-S DX NIKKOR 10–24mm f/3.5–4.5G ED	18–24 mm	No vignetting
	AF-S DX Zoom-Nikkor 12–24mm f/4G IF-ED	18 mm	1.0 m/3 ft 3 in.
		20–24 mm	No vignetting
	AF-S DX Zoom-Nikkor 17–55mm f/2.8G IF-ED	20 mm	2.0 m/6 ft 7 in.
		24–55 mm	1.0 m/3 ft 3 in.
	AF-S DX NIKKOR 18–200mm f/3.5–5.6G ED VR II	18 mm	1.0 m/3 ft 3 in.
	AF-S DX VR Zoom-Nikkor 18–200mm f/3.5–5.6G IF-ED	24–200 mm	No vignetting
AF-S DX NIKKOR 18–300mm f/3.5–5.6G ED VR	28 mm	1.0 m/3 ft 3 in.	
	50–300 mm	No vignetting	

	Lens	Zoom position	Minimum distance without vignetting
FX	AF-S NIKKOR 16–35mm f/4G ED VR	35 mm	1.5 m/4 ft 11 in.
	AF-S Zoom-Nikkor 17–35mm f/2.8D IF-ED	28 mm	1.5 m/4 ft 11 in.
		35 mm	No vignetting
	AF Zoom-Nikkor 18–35mm f/3.5–4.5D IF-ED	24 mm	1.0 m/3 ft 3 in.
		28–35 mm	No vignetting
	AF-S NIKKOR 18–35mm f/3.5–4.5G ED	28 mm	1.5 m/4 ft 11 in.
		35 mm	No vignetting
	AF Zoom-Nikkor 20–35mm f/2.8D IF	24 mm	1.5 m/4 ft 11 in.
		28 mm	1.0 m/3 ft 3 in.
		35 mm	No vignetting
	AF-S NIKKOR 20mm f/1.8G	20 mm	1.0 m/3 ft 3 in.
	AF-S NIKKOR 24mm f/1.4G ED	24 mm	1.0 m/3 ft 3 in.
	AF-S NIKKOR 24–70mm f/2.8G ED	35 mm	1.5 m/4 ft 11 in.
		50–70 mm	No vignetting
	AF-S VR Zoom-Nikkor 24–120mm f/3.5–5.6G IF-ED	24 mm	1.0 m/3 ft 3 in.
		35–120 mm	No vignetting
	AF-S NIKKOR 24–120mm f/4G ED VR	24 mm	2.0 m/6 ft 7 in.
		28 mm	1.0 m/3 ft 3 in.
		50–120 mm	No vignetting
	AF-S Zoom-Nikkor 28–70mm f/2.8D IF-ED	28 mm	1.0 m/3 ft 3 in.
50–70 mm		No vignetting	
AF-S NIKKOR 28–300mm f/3.5–5.6G ED VR	28 mm	1.5 m/4 ft 11 in.	
	35 mm	1.0 m/3 ft 3 in.	
	50–300 mm	No vignetting	
PC-E NIKKOR 24mm f/3.5D ED *	24 mm	1.5 m/4 ft 11 in.	

* When not shifted or tilted.

When used with the AF-S NIKKOR 14–24mm f/2.8G ED, the flash will be unable to light the entire subject at all ranges.

The built-in flash can also be used with the following non-CPU lenses: Nikon Series E and 24–300 mm NIKKOR (AI-S, AI-, and AI-modified). AI 50–300mm f/4.5, modified AI 50–300mm f/4.5, AI-S 50–300mm f/4.5 ED, and AI 50–300mm f/4.5 ED lenses must be used at a zoom position of 70 mm or above. With AI-S and AI 25–50mm f/4 ED lenses, the ranges above which vignetting will not occur are: 2.0 m (6 ft 7 in.) at a zoom position of 25 mm and 1.0 m (3 ft 3 in.) at a zoom position of 28 mm; vignetting will not occur at zoom positions of 35 mm or above.

Index

Symbols

(Auto mode).....	34
(Auto (flash off) mode).....	34
SCENE (Scene mode).....	41
EFFECTS (Special effects).....	46
(Portrait).....	42
(Landscape).....	42
(Child).....	42
(Sports).....	42
(Close up).....	43
(Night portrait).....	43
(Night landscape).....	43
(Party/indoor).....	43
(Beach/snow).....	44
(Sunset).....	44
(Dusk/dawn).....	44
(Pet portrait).....	44
(Candlelight).....	45
(Blossom).....	45
(Autumn colors).....	45
(Food).....	45
(Night vision).....	47
(Color sketch).....	47, 50
(Miniature effect).....	48, 51
(Selective color).....	48, 52
(Silhouette).....	48
(High key).....	49
(Low key).....	49
P (Programmed auto).....	89
S (Shutter-priority auto).....	90
A (Aperture-priority auto).....	91
M (Manual).....	93
U1/U2	99
S (Single frame).....	103
C_L (Continuous low speed).....	103, 338
C_H (Continuous high speed).....	103
Q (Quiet shutter-release).....	103


Qc (Qc shutter-release).....	103
(Self-timer).....	103, 106
MUP (Mirror up).....	104, 109
(Face-priority AF).....	58
(Wide-area AF).....	58
(Normal-area AF).....	58
(Subject-tracking AF).....	58
(Matrix).....	139, 335
(Center-weighted).....	139, 335
(Spot).....	139
(Highlight-weighted).....	139
AUTO (Auto flash).....	181
(Red-eye reduction).....	181, 183
SLOW (Slow sync).....	181, 183
REAR (Rear-curtain sync).....	183
(Exposure compensation).....	143
(Flash compensation).....	188
(Flexible program).....	89
(Live view) button.....	54, 66
i button.....	16, 61, 71, 198, 245, 396
(Info) button.....	12, 64, 75
switch.....	5, 342
WB (White balance).....	145, 321
PRE (Preset manual).....	145, 155
BKT (Bracketing).....	202
(Focus indicator).....	36, 129, 133
(Memory buffer).....	105
(Flash-ready indicator).....	40

Numerics

1.2x (30x20) 1.2x.....	110, 111
12-bit.....	117
14-bit.....	117
3D-tracking.....	124, 125, 126

A

AC adapter.....	441, 445
Accessories.....	441

Accessory terminal 443
Active D-Lighting 175, 212
Add items (My Menu) 421
ADL bracketing 212, 353
Adobe RGB 314
Advanced (HDMI) 279
AE & flash (Auto bracketing set) 202,
353
AE lock 141
AE only (Auto bracketing set) 202,
353
AE-L/AF-L button 129, 141, 361, 373
AF 57–59, 120–130
AF area brackets 10, 29, 247
AF fine-tune 389
AF point illumination 329
AF-A 121
AF-area mode 58, 123
AF-assist 332, 439
AF-C 121, 326
AF-F 57
AF-mode button 57, 59, 121, 125
AF-S 57, 121, 327
After delete 307
Angle of view 111, 432
Aperture 91–93
Aperture-priority auto 91
Aspect ratio 76, 399
Assign AE-L/AF-L button 361, 373
Assign Fn button 356, 370
Assign MB-D16  button 367
Assign movie record button 366
Assign preview button 361, 372
Assign remote (WR) Fn button 368
Assign shutter button 373
Auto (White balance) 145
Auto bracketing 202, 353
Auto bracketing set 353
Auto distortion control 316
Auto DX crop 111
Auto flash 181

Auto FP high-speed sync 345, 346
Auto image rotation 382
Auto ISO sensitivity control 136, 322
Auto-area AF 124, 126
Autoexposure lock 141
Autofocus 57–59, 120–130
Autofocus mode 57, 121
Auto-servo AF 121
Available settings 460

B

Backlight 5, 342
Backup (Role played by card in Slot
2) 119
Battery 25, 26, 30, 383, 487
Battery info 383
Battery life 494
Battery order 344
Battery pack .. 343, 344, 367, 383, 441
Beep 338
Black-and-white (Monochrome) .400
Blue intensifier (Filter effects) 401
Body cap 3, 442
Border 272
Bracketing 202, 353
Bracketing order 354
Built-in AF-assist illuminator 332
Built-in flash 40, 180
Bulb 93, 95
Burst 219, 339, 357

C

Calendar playback 244
Camera Control Pro 2 444
Capture NX-D 116, 268, 378, 384
CEC 278, 280
Center-weighted 139, 335
Charging the battery 25
Choose color temp. (White balance).
145, 152

Choose image area	71, 111, 113, 360, 362, 366
Choose start/end point	81
Clean image sensor	448
Clock	381
Clock battery	15
Cloudy (White balance)	145
CLS	433
Color balance	402
Color outline	413
Color sketch	47, 50, 414
Color space	314
Color temperature	145, 147, 152
Commander mode	348
Communication unit	269, 442
Compatible lenses	426
Compressed (Type)	117
Computer	262
Conformity marking	392, 489
Connector for external microphone	2
Continuous high speed	103
Continuous low speed	103, 338
Continuous release mode	103
Continuous-servo AF	121, 326
Control panel	8
Copy image(s)	303
Copyright	252, 385
CPU contacts	429
CPU lens	33, 426
Creative Lighting System	433
Cropping (PictBridge [Setup] menu)	272
Cross screen (Filter effects)	401
Custom Settings	323
Customize command dials	363
Cyanotype (Monochrome)	400
D	
Date and time	28, 381
Date format	381
Daylight saving time	381
DCF	488
Default settings ...	199, 292, 311, 318, 326
Delayed remote (Remote control mode (ML-L3))	193
Delete	38, 258
Delete all images	260
Delete current image	38, 258
Delete selected images	260
Depth-of-field	92
Destination	72, 319
Device control (HDMI)	278
Digital Print Order Format..	274, 275, 488
Diopter adjustment control	29, 443
Direct sunlight (White balance)	145
Distortion control	412
D-Lighting	397
DPOF	274, 275, 488
DPOF print order	275
DX (24 × 16) 1.5 ×	76, 110, 111
DX format	110
Dynamic-area AF	123, 126, 329
E	
Easy exposure compensation	334
Easy ISO	341
Edit movie	81, 245
Electronic rangefinder	133
Ethernet	269, 442
EV steps for exposure cntrl	333
Exif	488
Exposure	139–144
Exposure bracketing	202, 353
Exposure comp. for flash	353
Exposure compensation	143
Exposure delay mode	339
Exposure indicator	63, 94
Exposure lock	141
Exposure meters	39, 336

Exposure preview	55, 62
Exposure program	462
External microphone	73
Eye-Fi upload	391

F

Face detection.....	335
Face-priority AF	58
File naming.....	313
File number sequence.....	340
Filter effects.....	169, 401
Fine-tune optimal exposure	336
Fine-tuning white balance	149
Firmware version.....	392
Fisheye	413
Flash 40, 180, 181, 188, 190, 345, 433	
Flash (White balance)	145
Flash bracketing	202, 353
Flash cntrl for built-in flash.....	347
Flash compensation.....	188
Flash mode	181, 183
Flash only (Auto bracketing set) 202,	
353	
Flash range	187
Flash ready indicator	40, 191, 438
Flash shutter speed	185, 346
Flash sync speed	345, 346, 479
Flash warning.....	339
Flat (Set Picture Control)	165
Flexible program.....	89
Flicker reduction.....	380
Fluorescent (White balance)	145
Fn button.....	114, 356, 370
f-number	89, 92, 431
Focal length	237, 432
Focal plane mark.....	133
Focus indicator	36, 129, 133
Focus lock	129
Focus mode.....	57, 121
Focus point.....	58, 123, 127, 133, 329,
330, 331	

Focus point illumination.....	329
Focus point wrap-around.....	330
Focus tracking.....	122, 328
Focus tracking with lock-on.....	328
Focusing screen	479
Focus-mode selector	57, 120
Format memory card	375
Frame interval (Slide show)	308
Frame size/frame rate	71, 319
Framing guides	64, 75
Frequency response	71, 320
Front-curtain sync	183
Full-frame playback	241
Full-time servo AF.....	57
FV lock.....	190
FX (36 × 24) 1.0 ×	110, 111
FX format	110

G

GPS.....	239, 253
Green intensifier (Filter effects) ...	401
Group-area AF.....	124, 329

H

H.264	484
HDMI	65, 78, 277, 488
HDMI connector.....	2
HDMI-CEC.....	278, 280
Headphone volume.....	72
Headphones	73
Help	21
Hi (Sensitivity)	135
Hide image.....	301
High definition.....	277, 488
High Dynamic Range (HDR).....	177
High ISO NR	317
Highlight display.....	72
Highlights	248
Histogram.....	64, 249, 250, 355

I

Image area	76, 77, 110, 113, 118
Image comment	384
Image Dust Off ref photo	378
Image overlay	403
Image quality	115
Image review	234, 242, 307
Image size	118
Image type (Slide show)	308
Incandescent (White balance)	145
Index marking	70, 80, 370, 372
Index print	274
In-focus indicator	36, 129, 133
Information	12, 246
Information display	12, 64, 75, 341
Interval timer shooting	222
ISO sensitivity	134, 136, 322
ISO sensitivity settings	136, 322
ISO sensitivity step value	333
i-TTL	184, 185, 348

J

JPEG	115
JPEG basic	115
JPEG compression	117
JPEG fine	115
JPEG normal	115

L

L (large)	77, 118
LAN	442
Landscape (Set Picture Control) .	165
Language	381
LCD illumination	5, 342
Lens	27, 33, 235, 389, 426
Lens focus ring	60, 132
Lens mount	3, 133
Live view	54–65, 66–78
Live view photography	54
Live view selector	54, 66

Lo (Sensitivity)	135
Location data	239, 253
Lock mirror up for cleaning	451
Long exposure NR	317
Lossless compressed (Type)	117

M

M (medium)	77, 118
Manage Picture Control	170
Manual	93, 132
Manual (Flash cntrl for built-in flash) 347	
Manual focus	60, 132, 329
Matrix metering	139, 335
Max. continuous release	339
Maximum aperture	187, 430, 439
Maximum sensitivity	137, 322
MB-D16	343, 344, 367, 383, 441
MB-D16 battery type	343
Memory buffer	105
Memory card	26, 31, 119, 375, 491, 492
Memory card capacity	492
Metering	139
Microphone	73
Microphone sensitivity	71, 320
Miniature effect	48, 51, 416
Minimum aperture	33, 88
Minimum shutter speed	137
Mired	151
Mirror	109, 193, 451
Mirror up	104, 109
Mode dial	6
Mode dial lock release	6
Modeling flash	353
Monitor	17, 37, 54, 241, 376
Monitor brightness	62, 72, 376
Monitor color balance	377
Monitor off delay	337
Monitor pre-flash	185, 191
Monochrome	165, 400

Movie ISO sensitivity settings.....	322	Photo shooting menu.....	310
Movie live view	66, 370–373	PictBridge	271, 488
Movie quality	71, 320	Picture Controls.....	165, 167
Movie shooting menu	318	Picture size	432
Movie-record button	68, 366	PIN-entry WPS.....	285
Movies.....	66, 370–373	Pitching	388
Multiple exposure.....	216	Playback.....	37, 241
Multi-selector power aperture	72	Playback display options	302
My Menu	421	Playback folder	300
N		Playback information	246, 302
NEF (RAW).....	115, 117, 313, 406	Playback menu	300
NEF (RAW) bit depth	117	Playback slot and folder	245
NEF (RAW) processing.....	406	Playback zoom.....	255
NEF (RAW) recording	117	Portrait (Set Picture Control)	165
Network.....	269, 374	Power aperture.....	72, 73, 370, 372
Network connection	284	Power connector	441, 445
Neutral (Set Picture Control).....	165	Predictive focus tracking	122
Nikon Transfer 2	267	Preset manual (White balance)...	145, 155
No. of copies (PictBridge [Setup] menu)	272	Press the shutter-release button all the way down	36
Non-CPU lens.....	235, 427, 431	Press the shutter-release button halfway	36
Non-CPU lens data.....	235	Preview button.....	92, 361, 372
Normal-area AF.....	58	Print (DPOF).....	274
Number of focus points.....	330	Print options (PictBridge [Setup] menu).....	272
Number of shots.....	494	Print select.....	274
O		Printing.....	271
OK button	354	Programmed auto	89
Optimal quality (JPEG compression) 117		Protecting photographs	257
Optional flash	348, 433	Push-button WPS	284
Output resolution (HDMI)	278	Pv button.....	70, 92, 353, 361, 372
Overflow (Role played by card in Slot 2).....	119	Q	
Overview data	254	Qc (quiet continuous) shutter-release	103
P		Quick retouch	411
Page size.....	272	Quick-response remote (Remote control mode (ML-L3)).....	193
Perspective control	415	Quiet shutter-release	103
Photo information	246, 302		

R

Rank items (My Menu).....	424
RAW Slot 1 - JPEG Slot 2 (Role played by card in Slot 2)	119
Rear-curtain sync.....	183
Recent settings.....	425
Red intensifier (Filter effects)	401
Red-eye correction	398
Red-eye reduction	181, 183
Release button to use dial.....	365
Release mode	7, 103
Release mode dial.....	7, 103
Release mode dial lock release.....	7, 103
Remote control	193, 444
Remote control mode (ML-L3)	193
Remote cord.....	95, 443
Remote mirror-up (Remote control mode (ML-L3))	193
Remote on duration (ML-L3).....	337
Remove items (My Menu)	423
Removing the lens from the camera	33
Repeating flash	347
Reset	199, 311, 318, 326
Reset custom settings	326
Reset movie shooting menu.....	318
Reset photo shooting menu	311
Reset user settings.....	101
Resize.....	408
Restoring default settings... ..	199, 292, 311, 318, 326
Retouch menu.....	245, 393
Reverse indicators.....	366
RGB.....	249, 314
Role played by card in Slot 2.....	119
Rotate tall.....	308
S	
<hr/>	
S (small)	77, 118
Save selected frame	81, 86
Save user settings.....	99
Save/load settings.....	386
Saving camera settings.....	386
Scene mode	41
SD memory card.....	26, 31, 119, 491, 492
Select date.....	261, 274, 301
Select to send to smart device/ deselect	245, 289
Selective color.....	48, 52, 417
Self-timer	103, 106, 337
Sensitivity	134, 136, 322
Sepia (Monochrome).....	400
Set clock from satellite.....	239
Set Picture Control	165, 321
Setup menu	374
Shade (White balance).....	145
Shooting data	251
Shooting menus.....	310, 318
Shutter speed.....	90, 93
Shutter-priority auto.....	90
Shutter-release button .	36, 129, 141, 336, 373
Shutter-release button AE-L	336
Side-by-side comparison	419
Single frame.....	103
Single-point AF.....	123, 126
Single-servo AF.....	57, 121, 327
Size	77, 118
Size priority (JPEG compression). ..	117
Skylight (Filter effects)	401
Slide show	308
Slot	31, 119, 245, 319
Slot empty release lock.....	365
Slow sync	181, 183
Smart device.....	281
Soft (Filter effects).....	402
Speaker.....	4
Special effects	46
Speedlight.....	433
Spot.....	139

Spot white balance.....	159
sRGB.....	314
SSID.....	286
Standard (Set Picture Control)	165
Standard i-TTL flash for digital SLR....	185, 435
Standby timer.....	39, 239, 336
Start printing (PictBridge)	273, 275
Storage folder.....	311
Store points by orientation	331
Straighten	411
Sub-dial frame advance.....	364
Subject-tracking AF.....	58

T

Television.....	277
Thumbnail playback	243, 355
Tilting monitor	17
Time	28, 381
Time stamp (PictBridge)	272
Time zone	381
Time zone and date.....	381
Time-lapse photography.....	229
Timer.....	106, 222
Toning.....	168, 170
Trim	399
Trimming movies.....	81
Tripod.....	3
Two-button reset	199
Type D lens.....	426, 429
Type E lens.....	426, 429
Type G lens	426, 429

U

USB cable	266
User settings.....	99
UT-1.....	269, 442
UTC.....	240, 253

V

View SSID	287
-----------------	-----

Viewfinder	10, 29, 443, 478
Viewfinder eyepiece.....	107
Viewfinder eyepiece cap.....	107
Viewfinder focus	29, 443
Viewfinder grid display.....	341
ViewNX 2.....	262, 314
Vignette control	315
Virtual horizon	64, 75, 359, 388
Vivid (Set Picture Control)	165
Volume	80, 309

W

Warm filter (Filter effects)	401
WB	145, 208, 321
WB bracketing (Auto bracketing set)	208, 353
White balance	145, 208, 321
Wide-area AF.....	58
Wi-Fi.....	281
Wind noise reduction.....	72, 321
Wireless Mobile Utility .	281, 282, 283
Wireless network	269, 281, 442
Wireless remote controller..	197, 368
Wireless transmitter.....	269, 442
WT-5	269, 442

No reproduction in any form of this manual, in whole or in part (except for brief quotation in critical articles or reviews), may be made without written authorization from NIKON CORPORATION.

NIKON CORPORATION

© 2014 Nikon Corporation



SB4H01(11)
6MB25511-01