

Nikon

DIGITAL CAMERA

D7100

User's Manual

Package Contents

Confirm that the package contains the following items:

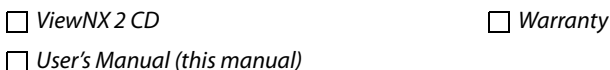
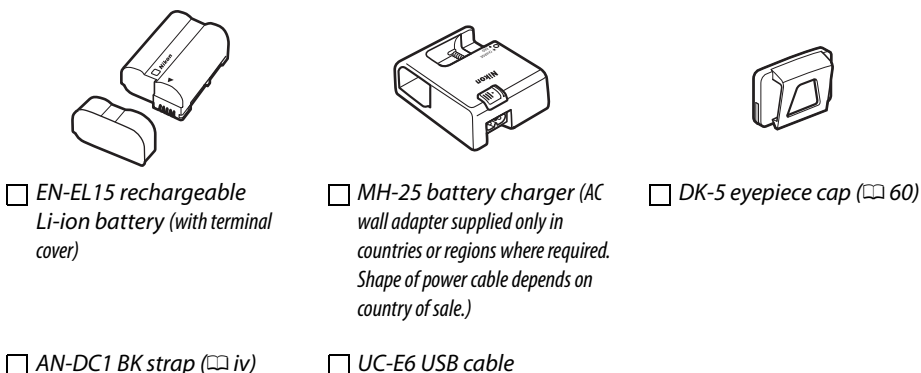
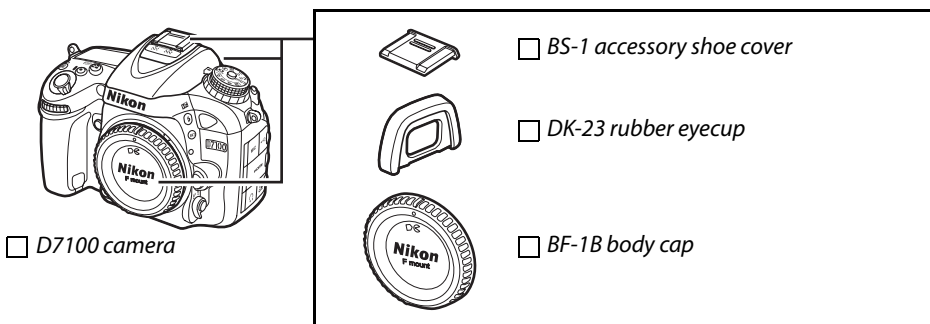

ViewNX 2 CD

Warranty

User's Manual (this manual)

Purchasers of the lens kit option should confirm that the package also includes a lens. Memory cards are sold separately (□ 347). Cameras purchased in Japan display menus and messages in English and Japanese only; other languages are not supported. We apologize for any inconvenience this may cause.

Digitutor

"Digitutor", a series of "watch and learn" manuals in movie form, is available from the following website: http://www.nikondigitutor.com/index_eng.html

For Your Safety

Before using the camera for the first time, read the safety instructions in "For Your Safety" (□ xxi–xxvi).

Where to Find It

Find what you're looking for from:

 The Table of Contents	 xii	 The Index.....	 352
 The Q&A Index.....	 ii	 Error Messages.....	 332
 Menu Options	 vi	 Troubleshooting	 328

 Introduction	 1
 Basic Photography and Playback	 35
 P, S, A, and M Modes	 47
 User Settings: U1 and U2 Modes	 55
 Release Mode	 57
 Image Recording Options	 63
 Focus	 71
 ISO Sensitivity	 79
 Exposure	 83
 White Balance	 89
 Image Enhancement	 105
 Flash Photography	 119
 Remote Control Photography	 127
 Other Shooting Options	 131
 Live View Photography	 153
 Movie Live View	 161
 Special Effects	 177
 More on Playback	 185
 Connections	 201
 Menu Guide	 217
 Technical Notes	 295

Q&A Index

Find what you're looking for using this "question and answer" index.



Taking Photographs



Shooting Modes and Framing Options

Is there a quick and easy way to take snapshots (AUTO mode)?	35–38
How do I quickly adjust settings for different scenes?	41
Can I use special effects during shooting?	177–183
Can I adjust shutter speed to freeze or blur motion (mode S)?	49
Can I adjust aperture to blur backgrounds or bring them into focus (mode A)?	50
How do I make long ("time") exposures (mode M)?	52
Can I frame photos in the monitor (live view photography)?	153
Can I shoot movies (movie live view)?	161



Release Modes

Can I take photos one at a time or in quick succession?	7, 57
How do I take pictures with the self-timer?	59
How do I take pictures with an optional ML-L3 remote control?	127
Can I reduce shutter noise in quiet surroundings (quiet shutter-release)?	7, 57



Focus

Can I choose how the camera focuses?	71–74
Can I choose the focus point?	75



Exposure

Can I make photos brighter or darker?	86
How do I preserve details in shadows and highlights?	113



Using the Flash

Can I set the flash to fire automatically when needed?	
How do I keep the flash from firing?	36, 119–123
How do I avoid "red-eye"?	



Image Quality and Size

How do I take pictures for printing at large sizes?	66–68
How can I get more pictures on the memory card?	



Viewing Photographs



Playback

How do I view photographs on the camera?	39, 185
How do I view more information about a photo?	187–192
Can I view photos in an automatic slide show?	223
Can I view photos on a TV?	215–216
Can I protect photos from accidental deletion?	196



Deletion

How do I delete unwanted photos?	40, 197–199
----------------------------------	-------------



Retouching Photographs



How do I create retouched copies of photos?	273–290
How do I remove “red-eye”?	276
How do I make JPEG copies of RAW (NEF) photos?	282
Can I overlay two NEF (RAW) photos to make a single image?	280–281
Can I create a copy of a photo that looks like a painting?	286
Can I trim movie footage on the camera or save movie stills?	173



Menus and Settings



How do I use the menus?	19–21
How do I display menus in another language?	28, 265
How do I use the command dials?	13–17
How do I keep the displays from turning off?	238
How do I focus the viewfinder?	33
Can I display a framing grid in the viewfinder or the monitor?	159, 166, 239
How do I tell if the camera is level?	269
How do I set the camera clock?	28, 265
How do I format memory cards?	32, 262
How do I restore default settings?	131, 224, 231
How do I get help for a menu or message?	19, 332



Connections



How do I copy photos to a computer?	203–207
How do I print photos?	208–214
Can I print the date of recording on my photos?	209, 214



Maintenance and Optional Accessories



What memory cards can I use?	347
What lenses can I use?	295
What optional flash units (Speedlights) can I use?	303
What other accessories are available for my camera?	308–310
What software is available for my camera?	
What do I do with the supplied eyepiece cap?	60
How do I clean the camera?	
Where should I take my camera for servicing and repairs?	312

Quick Start Guide

Follow these steps for a quick start with the D7100.

1 Attach the camera strap.

Attach the strap securely to the camera eyelets.

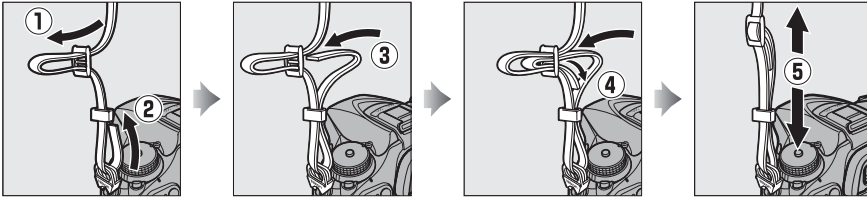

2 Charge (☞ 22) and insert the battery (☞ 24).

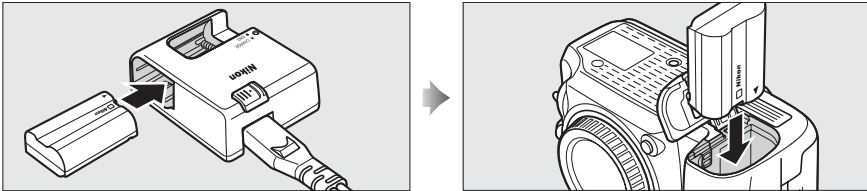

3 Attach a lens (☞ 26).

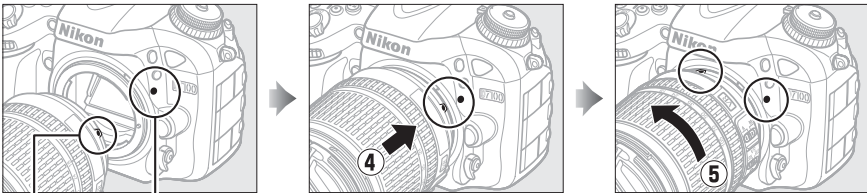

Mounting mark
(camera)

Mounting mark (lens)

Keeping marks (indicated by white dot) aligned, position lens on camera, then rotate until lens clicks into place.

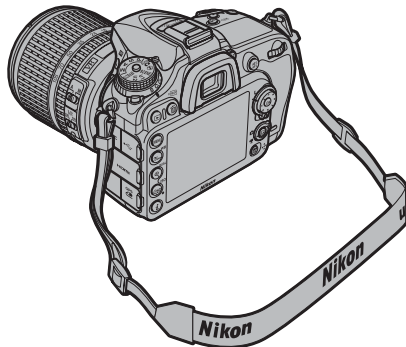

4 Insert a memory card (30).

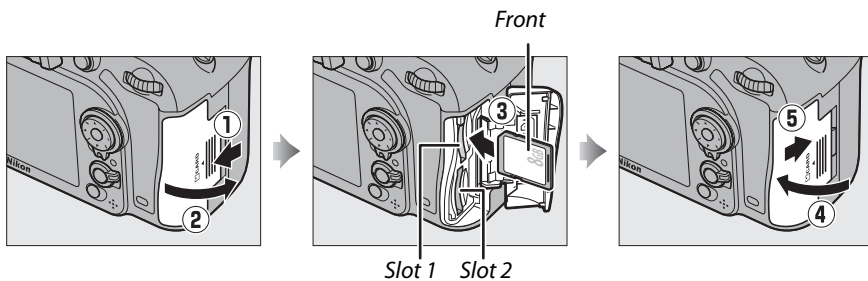

5 Turn the camera on.

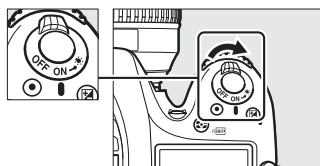

6 Frame the photograph (37).

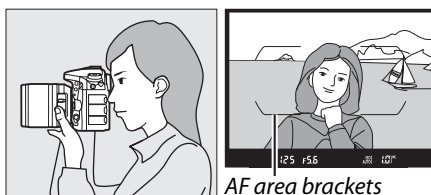

7 Focus and shoot (37).

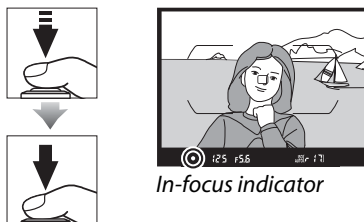

8 View the photograph (39).







See Also









For information on choosing a language and setting the time and date, see page 28. See page 33 for information on adjusting viewfinder focus.

Menu Options

▶ PLAYBACK MENU (📖 217)













Delete	Selected
	Select date
	All
Playback folder	D7100 (default)
	All
	Current
Hide image	Select/set
	Select date
	Deselect all?
Playback display options 	Basic photo info
	Focus point
	Additional photo info
	None (image only)
	Highlights
	RGB histogram
	Shooting data
Overview	
Copy image(s)	Select source
	Select image(s)
	Select destination folder
	Copy image(s)?
Image review 	On
	Off (default)
After delete 	Show next (default)
	Show previous
	Continue as before
Rotate tall 	On (default)
	Off
Slide show	Start
	Image type
	Frame interval
DPOF print order	Select/set
	Deselect all?

📷 SHOOTING MENU (📖 224)









Reset shooting menu	Yes
	No
Storage folder	Select folder by number
	Select folder from list
File naming 	File naming
Role played by card in Slot 2 	Overflow (default)
	Backup
	RAW Slot 1 - JPEG Slot 2
Image quality 	NEF (RAW) + JPEG fine
	NEF (RAW) + JPEG normal
	NEF (RAW) + JPEG basic
	NEF (RAW)
	JPEG fine
	JPEG normal (default)
JPEG basic	
Image size 	Large (default)
	Medium
	Small
Image area 	DX (24×16) (default)
	1.3× (18×12)
JPEG compression 	Size priority (default)
NEF (RAW) recording 	Optimal quality
NEF (RAW) recording 	Type
	NEF (RAW) bit depth
White balance 	Auto (default)
	Incandescent
	Fluorescent
	Direct sunlight
	Flash
	Cloudy
	Shade
	Choose color temp.
Preset manual	



Items marked with a  icon can be saved to the memory card using the **Save/load settings > Save settings** option in the camera setup menu (📖 268). The saved settings can be copied to other D7100 cameras by inserting the memory card into the camera and selecting **Save/load settings > Load settings**.

Set Picture Control	Standard (default)
	 Neutral
	Vivid
	Monochrome
	Portrait
Manage Picture Control	Landscape
	Save/edit
	Rename ¹
	Delete ¹
Color space	 sRGB (default)
	Adobe RGB
Active D-Lighting ²	Auto
	 Extra high
	High
	Normal
	Low
HDR (high dynamic range)	Off
	HDR mode
Auto distortion control	HDR strength
	 On (default)
Long exposure NR	Off (default)
High ISO NR	 High
	Normal (default)
	Low
ISO sensitivity settings	Off
	ISO sensitivity
 +  ( 79)	 +  Auto ISO sensitivity control
	( 82)
Remote control mode (ML-L3) 	Delayed remote
	Quick-response remote
	Remote mirror-up
	Off (default)
Multiple exposure	Multiple exposure mode
	Number of shots
	Auto gain

Interval timer shooting	Choose start time
	Now
	Start time
	Interval
Movie settings 	Select no. of times x no. of shots
	Start
	Frame size/frame rate
	Movie quality
	Microphone
	Destination

- 1 Not available if no custom Picture Controls are present.
- 2 Defaults to **Off** (modes **P, S, A, M**, , , , , , , , ) or **Auto** (other modes).

CUSTOM SETTING MENU (229)



Reset custom settings	Yes
	No
a Autofocus 	
a1 AF-C priority selection	Release (default)
	Focus
a2 AF-S priority selection	Release
	Focus (default)
a3 Focus tracking with lock-on	5 (Long)
	4
	3 (Normal) (default)
	2
	1 (Short)
a4 AF point illumination	Off
	Auto (default)
	On
a5 Focus point wrap-around	Off
	Wrap
a6 Number of focus points	No wrap (default)
	51 points (default)
a7 Built-in AF-assist illuminator	11 points
	On (default)
	Off

b Metering/exposure SD		
b1 ISO sensitivity step value	1/3 step	(default)
	1/2 step	
b2 EV steps for exposure cntrl	1/3 step	(default)
	1/2 step	
b3 Easy exposure compensation	On (Auto reset)	
	On	
	Off	(default)
b4 Center-weighted area	φ 6 mm	
	φ 8 mm	(default)
	φ 10 mm	
	φ 13 mm	
	Average	
b5 Fine-tune optimal exposure	Yes	
	No	(default)
c Timers/AE lock SD		
c1 Shutter-release button AE-L	On	
	Off	(default)
c2 Standby timer	4 s	
	6 s	(default)
	10 s	
	30 s	
	1 min	
	5 min	
	10 min	
30 min		
	No limit	
c3 Self-timer	Self-timer delay	
	Number of shots	
	Interval between shots	
c4 Monitor off delay	Playback	
	Menus	
	Information display	
	Image review	
	Live view	
c5 Remote on duration (ML-L3)	1 min	(default)
	5 min	
	10 min	
	15 min	

d Shooting/display SD		
d1 Beep	Volume	
	Pitch	
d2 Viewfinder grid display	On	
	Off	(default)
d3 ISO display and adjustment	Show ISO sensitivity	
	Show ISO/Easy ISO	
	Show frame count	(default)
d4 Screen tips	On	(default)
	Off	
d5 CL mode shooting speed	6 fps	
	5 fps	
	4 fps	
	3 fps	(default)
	2 fps	
	1 fps	
d6 Max. continuous release	1–100	
d7 File number sequence	On	(default)
	Off	
	Reset	
d8 Information display	Auto	(default)
	Manual	
d9 LCD illumination	On	
	Off	(default)
d10 Exposure delay mode	3 s	
	2 s	
	1 s	
	Off	(default)
d11 Flash warning	On	(default)
	Off	
d12 MB-D15 battery type	LR6 (AA alkaline)	(default)
	HR6 (AA Ni-MH)	
	FR6 (AA lithium)	
d13 Battery order	Use MB-D15 batteries first	(default)
	Use camera battery first	

e Bracketing/flash		(SD)
e1	Flash sync speed	1/320 s (Auto FP)
		1/250 s (Auto FP)
		1/250 s (default)
		1/200 s
		1/160 s
		1/125 s
		1/100 s
		1/80 s
e2	Flash shutter speed	1/60 s (default)
		1/30 s
		1/15 s
		1/8 s
		1/4 s
		1/2 s
		1 s
		2 s
		4 s
		8 s
15 s		
30 s		
e3	Flash cntrl for built-in flash	TTL (default)
		Manual
		Repeating flash
		Commander mode
e3	Optional flash *	TTL (default)
		Manual
e4	Exposure comp. for flash	Entire frame (default)
		Background only
e5	Modeling flash	On (default)
		Off
e6	Auto bracketing set	AE & flash (default)
		AE only
		Flash only
		WB bracketing
		ADL bracketing
e7	Bracketing order	MTR > under > over (default)
		Under > MTR > over

* Displayed only when optional SB-400 flash unit is attached.

f Controls		(SD)
f1	OK button	Shooting mode
		Playback mode
		Live view
f2	Assign Fn button	Press
		Press + command dials
f3	Assign preview button	Press
		Press + command dials
f4	Assign AE-L/AF-L button	Press
		Press + command dials
f5	Customize command dials	Reverse rotation
		Change main/sub
		Aperture setting
		Menus and playback
f6	Release button to use dial	Yes
		No (default)
f7	Slot empty release lock	Release locked
		Enable release (default)
f8	Reverse indicators	
		 (default)
f9	Assign MB-D15 button	AE/AF lock (default)
		AE lock only
		AE lock (Hold)
		AF lock only
		AF-ON
		FV lock
Same as Fn button		

g Movie		(SD)
g1	Assign Fn button	View photo shooting info
		AE/AF lock
		AE lock only
		AE lock (Hold)
		AF lock only
		AF-ON
		None (default)
g2	Assign preview button	View photo shooting info
		AE/AF lock
		AE lock only
		AE lock (Hold)
		AF lock only
		AF-ON
None (default)		

g Movie SD	
g3 Assign AE-L/ AF-L button	View photo shooting info
	AE/AF lock (default)
	AE lock only
	AE lock (Hold)
	AF lock only
	AF-ON
g4 Assign shutter button	Take photos (default)
	Record movies

Y SETUP MENU (261)

Format memory card	Slot 1
	Slot 2
Save user settings	Save to U1
	Save to U2
Reset user settings	Reset U1
	Reset U2
Monitor brightness	-5 - +5
Clean image sensor SD	Clean now
	Clean at startup/shutdown
Lock mirror up for cleaning ¹	Start
Image Dust Off ref photo	Start
	Clean sensor and then start
Flicker reduction SD	Auto (default)
	50 Hz
	60 Hz
Time zone and date SD	Time zone
	Date and time
	Date format
	Daylight saving time
Language SD	See page 340.
Auto image rotation SD	On (default)
	Off
Battery info	-
Image comment SD	Attach comment
	Input comment
Copyright information SD	Attach copyright information
	Artist
	Copyright
Save/load settings	Save settings
	Load settings
Virtual horizon	-

Non-CPU lens data SD	Lens number
	Focal length (mm)
	Maximum aperture
AF fine-tune	AF fine-tune (On/Off)
	Saved value
	Default
	List saved values
HDMI SD	Output resolution
	Device control
GPS SD	Standby timer
	Position
	Use GPS to set camera clock
Wireless mobile adapter	Enable (default)
	Disable
Network (available with optional UT-1)	Choose hardware
	Network settings
	Options
Eye-Fi upload ² SD	Slot 1
	Slot 2
Firmware version	-

1 Not available at battery levels of  or below.

2 Available only with compatible Eye-Fi memory cards.



RETOUCH MENU (📖 273)

D-Lighting	-
Red-eye correction	-
Trim	-
Monochrome	Black-and-white Sepia Cyanotype
Filter effects	Skylight Warm filter Red intensifier Green intensifier Blue intensifier Cross screen Soft
Color balance	-
Image overlay ¹	-
NEF (RAW) processing	-
Resize	Select image Choose destination Choose size
Quick retouch	-
Straighten	-
Distortion control	Auto Manual
Fisheye	-
Color outline	-
Color sketch	-
Perspective control	-
Miniature effect	-
Selective color	-
Edit movie	Choose start/end point Save selected frame
Side-by-side comparison ²	-

1 Available only when MENU button is pressed and  tab selected in menus.

2 Only available when  button is pressed to display retouch menu during full-frame playback.

MY MENU (📖 291)

Add items	 Playback menu Shooting menu Custom setting menu Setup menu Retouch menu
Remove items *	-
Rank items	-
Choose tab	 MY MENU RECENT SETTINGS



















* Items can also be deleted by highlighting them in MY MENU and pressing the  () button twice.

Table of Contents

Q&A Index	ii
Quick Start Guide.....	iv
Menu Options	vi
For Your Safety	xxi
Notices.....	xxiii

Introduction **1**

Overview.....	1
Getting to Know the Camera.....	2
The Camera Body	2
The Mode Dial.....	6
The Release Mode Dial	7
The Control Panel	8
The Viewfinder.....	9
The Information Display.....	10
The Command Dials	13
The <i>i</i> button	18
Camera Menus.....	19
Using Camera Menus	20
First Steps	22
Charge the Battery	22
Insert the Battery	24
Attach a Lens.....	26
Basic Setup.....	28
Insert a Memory Card.....	30
Format the Memory Card	32
Adjust Viewfinder Focus	33

Battery Level and Card Capacity	35
“Point-and-Shoot” Photography (AUTO and  Modes)	36
Basic Playback.....	39
Deleting Unwanted Photographs.....	40
Creative Photography (Scene Modes)	41
 Portrait.....	41
 Landscape	41
 Child.....	42
 Sports.....	42
 Close Up.....	42
 Night Portrait	42
 Night Landscape.....	43
 Party/Indoor	43
 Beach/Snow	43
 Sunset.....	43
 Dusk/Dawn	44
 Pet Portrait.....	44
 Candlelight.....	44
 Blossom.....	44
 Autumn Colors	45
 Food.....	45

P, S, A, and M Modes

P: Programmed Auto	48
S: Shutter-Priority Auto	49
A: Aperture-Priority Auto	50
M: Manual.....	51
Long Time-Exposures (M Mode Only)	52

User Settings: U1 and U2 Modes

Saving User Settings	55
Recalling User Settings	56
Resetting User Settings.....	56

Release Mode

Choosing a Release Mode	57
Frame Advance Rate.....	58
Self-Timer Mode.....	59
Mirror up Mode	61

Image Recording Options **63**

Image Area	63
Image Quality and Size	66
Image Quality	66
Image Size	68
Using Two Memory Cards	69

Focus **71**

Autofocus	71
Autofocus Mode	71
AF-Area Mode	73
Focus Point Selection	75
Focus Lock	76
Manual Focus	78

ISO Sensitivity **79**

Auto ISO Sensitivity Control	81
------------------------------------	----

Exposure **83**

Metering	83
Autoexposure Lock	84
Exposure Compensation	86

White Balance **89**

Fine-Tuning White Balance	91
Choosing a Color Temperature	94
Preset Manual	95

Image Enhancement **105**

Picture Controls	105
Selecting a Picture Control	105
Modifying Picture Controls	107
Creating Custom Picture Controls	110
Sharing Custom Picture Controls	112
Preserving Detail in Highlights and Shadows	113
Active D-Lighting	113
High Dynamic Range (HDR)	115

Flash Photography **119**

Using the Built-in Flash.....	119
Flash Mode.....	120
Flash Compensation.....	124
FV Lock.....	125

Remote Control Photography **127**

Using an Optional ML-L3 Remote Control	127
Wireless Remote Controllers	130
WR-1 Wireless Remote Controllers.....	130
WR-R10/WR-T10 Wireless Remote Controllers.....	130

Other Shooting Options **131**

Two-Button Reset: Restoring Default Settings.....	131
Bracketing	133
Multiple Exposure.....	141
Interval Timer Photography.....	145
Non-CPU Lenses.....	149
Using a GPS Unit	152

Live View Photography **153**







Focusing in Live View	155
Using the i Button	157
The Live View Display: Live View Photography	158
The Information Display: Live View Photography	159
Manual Focus	159

Movie Live View **161**

Using the i Button	164
The Live View Display: Movie Live View	165
The Information Display: Movie Live View.....	166
Image Area	167
Movie Settings	169
Viewing Movies	171
Editing Movies	173
Trimming Movies.....	173
Saving Selected Frames.....	176

Special Effects

177

Shooting with Special Effects.....	177
 Night Vision.....	178
 Color Sketch	178
 Miniature Effect	178
 Selective Color	179
 Silhouette	179
 High Key	179
 Low Key	179
Options Available in Live View	180

More on Playback

185

Full-Frame Playback.....	185
Photo Information.....	187
Thumbnail Playback	193
Calendar Playback	194
Taking a Closer Look: Playback Zoom.....	195
Protecting Photographs from Deletion.....	196
Deleting Photographs	197
Full-Frame, Thumbnail, and Calendar Playback.....	197
The Playback Menu.....	198

Connections

201

Installing ViewNX 2	201
Using ViewNX 2	203
Copy Pictures to the Computer.....	203
View Pictures.....	204
Ethernet and Wireless Networks.....	206
Printing Photographs.....	208
Connecting the Printer	208
Printing Pictures One at a Time	209
Printing Multiple Pictures.....	210
Creating a DPOF Print Order: Print Set	213
Viewing Photographs on TV.....	215

▶ The Playback Menu: <i>Managing Images</i>	217
Playback Folder	217
Hide Image	218
Playback Display Options	219
Copy Image(s)	219
Image Review	222
After Delete	222
Rotate Tall	222
Slide Show	223
📷 The Shooting Menu: <i>Shooting Options</i>	224
Reset Shooting Menu	224
Storage Folder	225
File Naming	226
Color Space	227
Auto Distortion Control	227
Long Exposure NR (Long Exposure Noise Reduction)	228
High ISO NR	228
✎ Custom Settings: <i>Fine-Tuning Camera Settings</i>	229
Reset Custom Settings	231
a: Autofocus	231
a1: AF-C Priority Selection	231
a2: AF-S Priority Selection	231
a3: Focus Tracking with Lock-On	232
a4: AF Point Illumination	232
a5: Focus Point Wrap-Around	232
a6: Number of Focus Points	233
a7: Built-in AF-assist Illuminator	233
b: Metering/Exposure	234
b1: ISO Sensitivity Step Value	234
b2: EV Steps for Exposure Cntrl	234
b3: Easy Exposure Compensation	235
b4: Center-Weighted Area	236
b5: Fine-tune Optimal Exposure	236
c: Timers/AE Lock	236
c1: Shutter-Release Button AE-L	236
c2: Standby timer	237
c3: Self-Timer	237
c4: Monitor off Delay	238
c5: Remote on Duration (ML-L3)	238

d: Shooting/Display	238
d1: Beep	238
d2: Viewfinder Grid Display	239
d3: ISO Display and Adjustment	239
d4: Screen Tips	239
d5: CL Mode Shooting Speed	239
d6: Max. Continuous Release	240
d7: File Number Sequence	240
d8: Information Display	241
d9: LCD Illumination	241
d10: Exposure Delay Mode	241
d11: Flash Warning	241
d12: MB-D15 Battery Type	242
d13: Battery Order	243
e: Bracketing/Flash	244
e1: Flash Sync Speed	244
e2: Flash Shutter Speed	245
e3: Flash Cntrl for Built-in Flash	246
e4: Exposure Comp. for Flash	250
e5: Modeling Flash	251
e6: Auto Bracketing Set	251
e7: Bracketing Order	251
f: Controls	252
f1: OK Button	252
f2: Assign Fn Button	253
f3: Assign Preview Button	255
f4: Assign AE-L/AF-L Button	256
f5: Customize Command Dials	257
f6: Release Button to Use Dial	258
f7: Slot Empty Release Lock	258
f8: Reverse Indicators	258
f9: Assign MB-D15  Button	259
g: Movie	259
g1: Assign Fn Button	259
g2: Assign Preview Button	260
g3: Assign AE-L/AF-L Button	260
g4: Assign Shutter Button	260

⌘ The Setup Menu: <i>Camera Setup</i>	261
Format Memory Card	262
Monitor Brightness	262
Image Dust Off Ref Photo.....	263
Flicker Reduction.....	264
Time Zone and Date.....	265
Language	265
Auto Image Rotation.....	265
Battery Info	266
Image Comment.....	266
Copyright Information.....	267
Save/Load Settings	268
Virtual Horizon.....	269
AF Fine-tune.....	270
Wireless Mobile Adapter.....	271
Eye-Fi Upload.....	272
Firmware Version.....	272
🔧 The Retouch Menu: <i>Creating Retouched Copies</i>	273
Creating Retouched Copies	274
D-Lighting.....	276
Red-Eye Correction	276
Trim	277
Monochrome	277
Filter Effects.....	278
Color Balance	279
Image Overlay.....	280
NEF (RAW) Processing.....	282
Resize	283
Quick Retouch	284
Straighten	285
Distortion Control	285
Fisheye	285
Color Outline.....	286
Color Sketch	286
Perspective Control	286
Miniature Effect.....	287
Selective Color.....	288
Side-by-side Comparison	290
📄 My Menu / 📄 Recent Settings.....	291
Recent Settings.....	294

Compatible Lenses.....	295
Optional Flash Units (Speedlights).....	303
The Nikon Creative Lighting System (CLS).....	304
Other Accessories.....	308
Attaching a Power Connector and AC Adapter.....	311
Caring for the Camera.....	312
Storage.....	312
Cleaning.....	312
Image Sensor Cleaning.....	313
“Clean Now”.....	313
“Clean at Startup/Shutdown”.....	314
Manual Cleaning.....	315
Caring for the Camera and Battery: Cautions.....	318
Available Settings.....	321
Defaults.....	324
Exposure Program (Mode P).....	327
Troubleshooting.....	328
Battery/Display.....	328
Shooting (All Modes).....	328
Shooting (P, S, A, M).....	330
Playback.....	330
Miscellaneous.....	331
Error Messages.....	332
Specifications.....	336
The AF-S DX NIKKOR 18–105mm f/3.5–5.6G ED VR.....	343
Approved Memory Cards.....	347
Memory Card Capacity.....	348
Battery Life.....	350
Index.....	352

For Your Safety











To prevent damage to your Nikon product or injury to yourself or to others, read the following safety precautions in their entirety before using this equipment. Keep these safety instructions where all those who use the product will read them.

The consequences that could result from failure to observe the precautions listed in this section are indicated by the following symbol:



This icon marks warnings. To prevent possible injury, read all warnings before using this Nikon product.

■ ■ WARNINGS

-  **Keep the sun out of the frame**
Keep the sun well out of the frame when shooting backlit subjects. Sunlight focused into the camera when the sun is in or close to the frame could cause a fire.
-  **Do not look at the sun through the viewfinder**
Viewing the sun or other strong light source through the viewfinder could cause permanent visual impairment.
-  **Using the viewfinder diopter adjustment control**
When operating the viewfinder diopter adjustment control with your eye to the viewfinder, care should be taken not to put your finger in your eye accidentally.
-  **Turn off immediately in the event of malfunction**
Should you notice smoke or an unusual smell coming from the equipment or AC adapter (available separately), unplug the AC adapter and remove the battery immediately, taking care to avoid burns. Continued operation could result in injury. After removing the battery, take the equipment to a Nikon-authorized service center for inspection.
-  **Do not use in the presence of flammable gas**
Do not use electronic equipment in the presence of flammable gas, as this could result in explosion or fire.
-  **Do not place the strap around the neck of an infant or child**
Placing the camera strap around the neck of an infant or child could result in strangulation.
-  **Keep out of reach of children**
Failure to observe this precaution could result in injury. In addition, note that small parts constitute a choking hazard. Should a child swallow any part of this equipment, consult a physician immediately.
-  **Do not disassemble**
Touching the product's internal parts could result in injury. In the event of malfunction, the product should be repaired only by a qualified technician. Should the product break open as the result of a fall or other accident, remove the battery and/or AC adapter and then take the product to a Nikon-authorized service center for inspection.
-  **Do not remain in contact with the camera, battery, or charger for extended periods while the devices are on or in use**
Parts of the device become hot. Leaving the device in direct contact with the skin for extended periods may result in low-temperature burns.
-  **Do not aim a flash at the operator of a motor vehicle**
Failure to observe this precaution could result in accidents.
-  **Avoid contact with liquid crystal**
Should the monitor break, care should be taken to avoid injury due to broken glass and to prevent the liquid crystal from the monitor touching the skin or entering the eyes or mouth.

⚠ Observe caution when using the flash

- Using the camera with the flash in close contact with the skin or other objects could cause burns.
- Using the flash close to the subject's eyes could cause temporary visual impairment. Particular care should be observed when photographing infants, when the flash should be no less than one meter (39 in.) from the subject.

⚠ Observe proper precautions when handling batteries

Batteries may leak or explode if improperly handled. Observe the following precautions when handling batteries for use in this product:

- Use only batteries approved for use in this equipment.
- Do not short or disassemble the battery.
- Be sure the product is off before replacing the battery. If you are using an AC adapter, be sure it is unplugged.
- Do not attempt to insert the battery upside down or backwards.
- Do not expose the battery to flame or to excessive heat.
- Do not immerse in or expose to water.
- Replace the terminal cover when transporting the battery. Do not transport or store the battery with metal objects such as necklaces or hairpins.
- Batteries are prone to leakage when fully discharged. To avoid damage to the product, be sure to remove the battery when no charge remains.
- When the battery is not in use, attach the terminal cover and store in a cool, dry place.
- The battery may be hot immediately after use or when the product has been used on battery power for an extended period. Before removing the battery turn the camera off and allow the battery to cool.
- Discontinue use immediately should you notice any changes in the battery, such as discoloration or deformation.

⚠ Observe proper precautions when handling the charger

- Keep dry. Failure to observe this precaution could result in fire or electric shock.
- Dust on or near the metal parts of the plug should be removed with a dry cloth. Continued use could result in fire.
- Do not handle the power cable or go near the charger during thunderstorms. Failure to observe this precaution could result in electric shock.
- Do not damage, modify, or forcibly tug or bend the power cable. Do not place it under heavy objects or expose it to heat or flame. Should the insulation be damaged and the wires become exposed, take the power cable to a Nikon-authorized service representative for inspection. Failure to observe this precaution could result in fire or electric shock.
- Do not handle the plug or charger with wet hands. Failure to observe this precaution could result in electric shock.
- Do not use with travel converters or adapters designed to convert from one voltage to another or with DC-to-AC inverters. Failure to observe this precaution could damage the product or cause overheating or fire.

⚠ Use appropriate cables

When connecting cables to the input and output jacks, use only the cables provided or sold by Nikon for the purpose to maintain compliance with product regulations.

⚠ CD-ROMs

CD-ROMs containing software or manuals should not be played back on audio CD equipment. Playing CD-ROMs on an audio CD player could cause hearing loss or damage the equipment.

Notices

- No part of the manuals included with this product may be reproduced, transmitted, transcribed, stored in a retrieval system, or translated into any language in any form, by any means, without Nikon's prior written permission.
- Nikon reserves the right to change the specifications of the hardware and software described in these manuals at any time and without prior notice.
- Nikon will not be held liable for any damages resulting from the use of this product.
- While every effort has been made to ensure that the information in these manuals is accurate and complete, we would appreciate it were you to bring any errors or omissions to the attention of the Nikon representative in your area (address provided separately).

Notices for Customers in Canada

CAUTION

This Class B digital apparatus complies with Canadian ICES-003.

ATTENTION

Cet appareil numérique de la classe B est conforme à la norme NMB-003 du Canada.

Notices for Customers in Europe

CAUTION

RISK OF EXPLOSION IF BATTERY IS REPLACED BY AN INCORRECT TYPE. DISPOSE OF USED BATTERIES ACCORDING TO THE INSTRUCTIONS.

This symbol indicates that electrical and electronic equipment is to be collected separately.



The following apply only to users in European countries:

- This product is designated for separate collection at an appropriate collection point. Do not dispose of as household waste.
- Separate collection and recycling helps conserve natural resources and prevent negative consequences for human health and the environment that might result from incorrect disposal.
- For more information, contact the retailer or the local authorities in charge of waste management.

This symbol on the battery indicates that the battery is to be collected separately.



The following apply only to users in European countries:

- All batteries, whether marked with this symbol or not, are designated for separate collection at an appropriate collection point. Do not dispose of as household waste.
- For more information, contact the retailer or the local authorities in charge of waste management.

Notices for Customers in the U.S.A.

Power Cable

At voltages over AC 125 V (U.S.A. only): The power cable must be rated for the voltage in use, be at least AWG no. 18 gauge, and have SVG insulation or better with a NEMA 6P-15 plug rated for AC 250 V 15 A.

Federal Communications Commission (FCC) Radio Frequency Interference Statement

This equipment has been tested and found to comply with the limits for a Class B digital device, pursuant to Part 15 of the FCC rules. These limits are designed to provide reasonable protection against harmful interference in a residential installation. This equipment generates, uses, and can radiate radio frequency energy and, if not installed and used in accordance with the instructions, may cause harmful interference to radio communications. However, there is no guarantee that interference will not occur in a particular installation. If this equipment does cause harmful interference to radio or television reception, which can be determined by turning the equipment off and on, the user is encouraged to try to correct the interference by one or more of the following measures:

- Reorient or relocate the receiving antenna.
- Increase the separation between the equipment and receiver.
- Connect the equipment into an outlet on a circuit different from that to which the receiver is connected.
- Consult the dealer or an experienced radio/television technician for help.



CAUTIONS

Modifications

The FCC requires the user be notified that any changes or modifications made to this device that are not expressly approved by Nikon Corporation may void the user's authority to operate the equipment.

Interface Cables

Use the interface cables sold or provided by Nikon for your equipment. Using other interface cables may exceed the limits of Class B Part 15 of the FCC rules.

Notice for Customers in the State of California

WARNING: Handling the cord on this product may expose you to lead, a chemical known to the State of California to cause birth defects or other reproductive harm. *Wash hands after handling.*

Nikon Inc., 1300 Walt Whitman Road,
Melville, New York 11747-3064, U.S.A.
Tel.: 631-547-4200

Notice Concerning Prohibition of Copying or Reproduction

Note that simply being in possession of material that has been digitally copied or reproduced by means of a scanner, digital camera, or other device may be punishable by law.

- **Items prohibited by law from being copied or reproduced**

Do not copy or reproduce paper money, coins, securities, government bonds, or local government bonds, even if such copies or reproductions are stamped "Sample."

The copying or reproduction of paper money, coins, or securities which are circulated in a foreign country is prohibited.

Unless the prior permission of the government has been obtained, the copying or reproduction of unused postage stamps or post cards issued by the government is prohibited.

The copying or reproduction of stamps issued by the government and of certified documents stipulated by law is prohibited.

- **Cautions on certain copies and reproductions**

The government has issued cautions on copies or reproductions of securities issued by private companies (shares, bills, checks, gift certificates, etc.), commuter passes, or coupon tickets, except when a minimum of necessary copies are to be provided for business use by a company. Also, do not copy or reproduce passports issued by the government, licenses issued by public agencies and private groups, ID cards, and tickets, such as passes and meal coupons.

- **Comply with copyright notices**

The copying or reproduction of copyrighted creative works such as books, music, paintings, woodcuts, prints, maps, drawings, movies, and photographs is governed by national and international copyright laws. Do not use this product for the purpose of making illegal copies or to infringe copyright laws.

Disposing of Data Storage Devices

Please note that deleting images or formatting memory cards or other data storage devices does not completely erase the original image data. Deleted files can sometimes be recovered from discarded storage devices using commercially available software, potentially resulting in the malicious use of personal image data. Ensuring the privacy of such data is the user's responsibility.

Before discarding a data storage device or transferring ownership to another person, erase all data using commercial deletion software, or format the device and then completely refill it with images containing no private information (for example, pictures of empty sky). Be sure to also replace any pictures selected for preset manual (□ 95). Care should be taken to avoid injury when physically destroying data storage devices.

AVC Patent Portfolio License

THIS PRODUCT IS LICENSED UNDER THE AVC PATENT PORTFOLIO LICENSE FOR THE PERSONAL AND NON-COMMERCIAL USE OF A CONSUMER TO (i) ENCODE VIDEO IN COMPLIANCE WITH THE AVC STANDARD ("AVC VIDEO") AND/OR (ii) DECODE AVC VIDEO THAT WAS ENCODED BY A CONSUMER ENGAGED IN A PERSONAL AND NON-COMMERCIAL ACTIVITY AND/OR WAS OBTAINED FROM A VIDEO PROVIDER LICENSED TO PROVIDE AVC VIDEO. NO LICENSE IS GRANTED OR SHALL BE IMPLIED FOR ANY OTHER USE. ADDITIONAL INFORMATION MAY BE OBTAINED FROM MPEG LA, L.L.C. SEE <http://www.mpegla.com>

Use Only Nikon Brand Electronic Accessories

Nikon cameras are designed to the highest standards and include complex electronic circuitry. Only Nikon brand electronic accessories (including chargers, batteries, AC adapters, and flash accessories) certified by Nikon specifically for use with this Nikon digital camera are engineered and proven to operate within the operational and safety requirements of this electronic circuitry.

The use of non-Nikon electronic accessories could damage the camera and may void your Nikon warranty. The use of third-party rechargeable Li-ion batteries not bearing the Nikon holographic seal shown at right could interfere with normal operation of the camera or result in the batteries overheating, igniting, rupturing, or leaking.

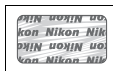

For more information about Nikon brand accessories, contact a local authorized Nikon dealer.

Before Taking Important Pictures

Before taking pictures on important occasions (such as at weddings or before taking the camera on a trip), take a test shot to ensure that the camera is functioning normally. Nikon will not be held liable for damages or lost profits that may result from product malfunction.

Life-Long Learning

As part of Nikon's "Life-Long Learning" commitment to ongoing product support and education, continually-updated information is available on-line at the following sites:

- **For users in the U.S.A.:** <http://www.nikonusa.com/>
- **For users in Europe and Africa:** <http://www.europe-nikon.com/support/>
- **For users in Asia, Oceania, and the Middle East:** <http://www.nikon-asia.com/>

Visit these sites to keep up-to-date with the latest product information, tips, answers to frequently-asked questions (FAQs), and general advice on digital imaging and photography. Additional information may be available from the Nikon representative in your area. See the following URL for contact information: <http://imaging.nikon.com/>



Introduction

Overview

Thank you for your purchase of a Nikon single-lens reflex (SLR) digital camera. To get the most from your camera, please be sure to read all instructions thoroughly and keep them where they will be read by all who use the product.

■ **Symbols and Conventions**

To make it easier to find the information you need, the following symbols and conventions are used:



This icon marks cautions; information that should be read before use to prevent damage to the camera.



This icon marks notes; information that should be read before using the camera.



This icon marks references to other pages in this manual.

Menu items, options, and messages displayed in the camera monitor are shown in **bold**.



Camera Settings

The explanations in this manual assume that default settings are used.



Help

Use the camera's on-board help feature for help on menu items and other topics. See page 19 for details.



Use Only Nikon Brand Accessories

Only Nikon brand accessories certified by Nikon specifically for use with your Nikon digital camera are engineered and proven to operate within its operational and safety requirements. **THE USE OF NON-NIKON ACCESSORIES COULD DAMAGE YOUR CAMERA AND MAY VOID YOUR NIKON WARRANTY.**



Servicing the Camera and Accessories

The camera is a precision device and requires regular servicing. Nikon recommends that the camera be inspected by the original retailer or a Nikon-authorized service representative once every one to two years, and that it be serviced once every three to five years (note that fees apply to these services). Frequent inspection and servicing are particularly recommended if the camera is used professionally. Any accessories regularly used with the camera, such as lenses or optional flash units, should be included when the camera is inspected or serviced.



Getting to Know the Camera

Take a few moments to familiarize yourself with camera controls and displays. You may find it helpful to bookmark this section and refer to it as you read through the rest of the manual.

The Camera Body

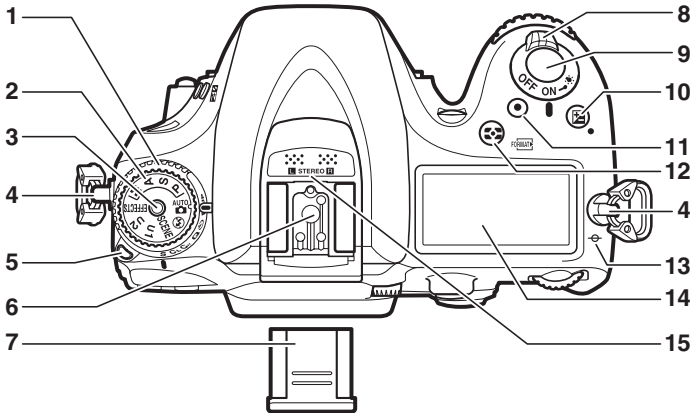

1 Release mode dial.....	7, 57	11 Movie-record button	162
2 Mode dial	6	12 button	
3 Mode dial lock release	6	Metering	83
4 Eyelet for camera strap		Formatting memory cards	32
5 Release mode dial lock release.....	7, 57	13 Focal plane mark (-∞)	78
6 Accessory shoe (for optional flash unit)	303	14 Control panel.....	8
7 Accessory shoe cover.....	303	15 Stereo microphone	164, 169
8 Power switch	2		
9 Shutter-release button	37, 38		
10 button			
Exposure compensation	86		
Two-button reset	131		

The Power Switch

Rotate the power switch as shown to turn the camera on.

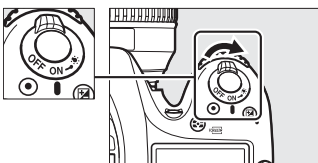

Rotate the power switch as shown to turn the camera off.

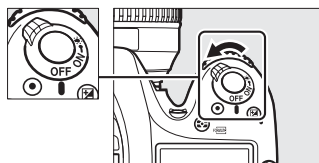

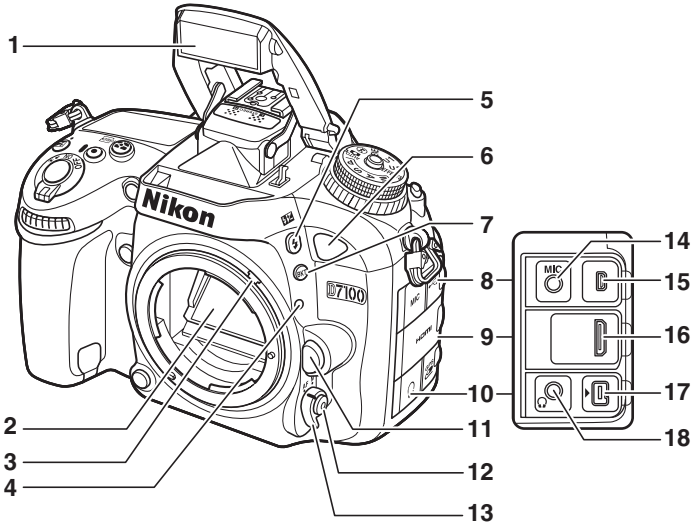

<p>1 Built-in flash 119</p> <p>2 Mirror 61, 315</p> <p>3 Meter coupling lever.....338</p> <p>4 Lens mounting mark..... 27</p> <p>5 button Flash mode.....119 Flash compensation.....124</p> <p>6 Infrared receiver (front) 128</p> <p>7 BKT button Bracketing 133, 137, 139</p> <p>8 Cover for USB and external microphone connectors 165, 310</p> <p>9 HDMI connector cover.....203, 208, 215</p>	<p>10 Cover for accessory terminal and headphone connectors 310</p> <p>11 Lens release button27</p> <p>12 AF-mode button.....72, 74, 155</p> <p>13 Focus-mode selector71, 78</p> <p>14 Connector for external microphone..... 165</p> <p>15 USB connector Connecting to a computer..... 203 Connecting to a printer 208</p> <p>16 HDMI mini connector (Type C)..... 215</p> <p>17 Accessory terminal..... 130, 152, 310</p> <p>18 Headphone connector..... 165</p>
---	---

LCD Illuminators

Rotating the power switch toward activates the standby timer and control panel backlight (LCD illuminator), allowing the display to be read in the dark. After the power switch is released and returns to the **ON** position, the illuminators will remain lit for six seconds while the standby timer is active or until the shutter is released or the power switch is rotated toward again.

Power switch

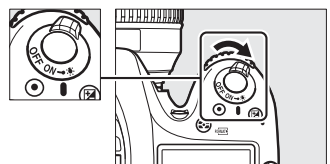

The Camera Body (Continued)

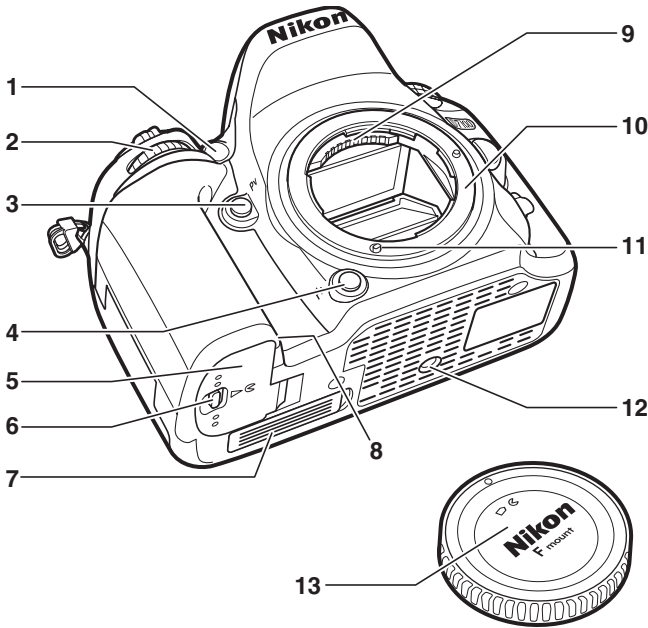

1 AF-assist illuminator.....	233	7 Contact cover for optional MB-D15 battery pack	308
Self-timer lamp.....	59	308
Red-eye reduction lamp	121	8 Power connector cover	311
2 Sub-command dial.....	13, 257	9 CPU contacts	
3 Depth-of-field preview button.....	50, 255, 260	10 Lens mount	27, 78
4 Fn (function) button	65, 125, 151, 253, 259	11 AF coupling	
5 Battery-chamber cover.....	24	12 Tripod socket	
6 Battery-chamber cover latch	24	13 Body cap	26, 309

The Microphone and Speaker

Do not place the microphone or speaker in close proximity to magnetic devices. Failure to observe this precaution could affect the data recorded on the magnetic devices.

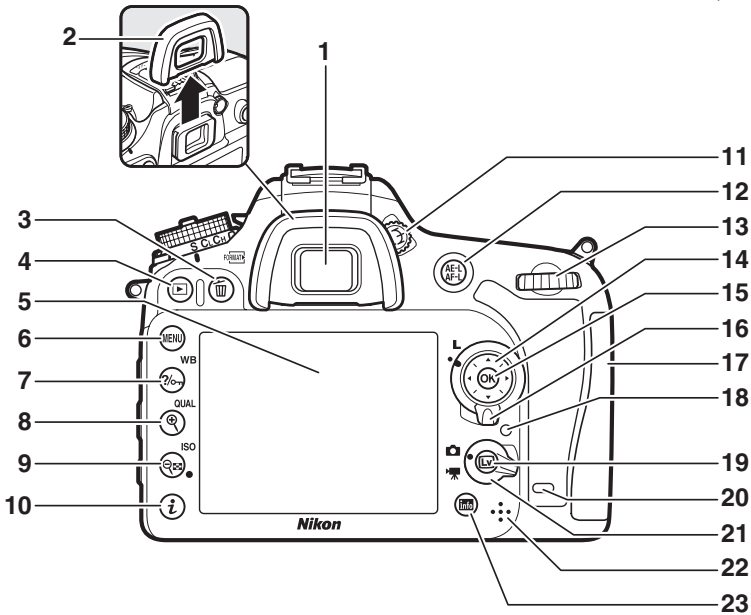

1	Viewfinder eyepiece..... 33	10	i button 18 Changing settings in the information display 12 Changing settings during live view/movie recording..... 157, 164 Retouching pictures 275
2	Rubber eyecup 60	11	Diopter adjustment control 33
3	⏏/FORMAT button Delete 40, 197 Formatting memory cards 32	12	AE/AF-L button Using the AE/AF lock button .. 76, 84, 256, 260
4	▶ button Playback..... 39, 185	13	Main command dial..... 13, 257
5	Monitor Viewing settings 10 Live view 153, 161 Viewing pictures 39 Full-frame playback 185	14	Multi selector..... 20
6	MENU button Menu..... 19, 217	15	OK (OK) button..... 20, 252
7	W/B button Help..... 19 Protect..... 196 White balance..... 89, 91, 94	16	Focus selector lock..... 75
8	QUAL button Playback zoom in..... 195 Image quality/size..... 66, 68	17	Memory card slot cover 30
9	ISO button Playback zoom out/thumbnails..... 193, 194 ISO sensitivity 79 Auto ISO sensitivity control..... 82 Two-button reset..... 131	18	Memory card access lamp..... 30, 37
		19	LV button 153, 161
		20	Infrared receiver (rear) 128
		21	Live view selector Live view photography 153 Movie live view 161
		22	Speaker
		23	INFO (info) button Viewing the information display 10 Hiding and displaying indicators during live view 159, 166



The Mode Dial

The camera offers the modes listed below. To choose a mode, press the mode dial lock release and rotate the mode dial.

Mode dial

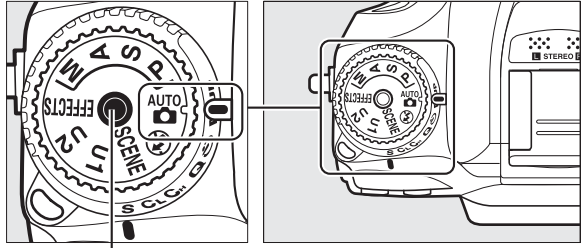

Mode dial lock release

Special Effects Modes (☞ 177)

Use special effects during shooting.

P, S, A, and M Modes

Select these modes for full control over camera settings.

- **P**—Programmed auto (☞ 48)
- **S**—Shutter-priority auto (☞ 49)
- **A**—Aperture-priority auto (☞ 50)
- **M**—Manual (☞ 51)

Auto Modes

Select these modes for simple, point-and-shoot photography.

- **Auto** (☞ 36)
- **Auto (flash off)** (☞ 36)

Scene Modes (☞ 41)

The camera automatically optimizes settings to suit the selected scene. Match your selection to the scene being photographed.

U1 and U2 Modes (☞ 55)

Store and recall customized shooting settings.

Non-CPU Lenses

Non-CPU (☞ 295) lenses can be used only in modes **A** and **M**. Selecting another mode when a non-CPU lens is attached disables the shutter release.





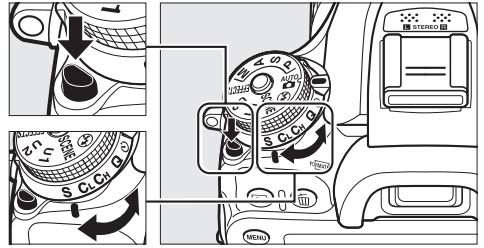

The Release Mode Dial

To choose a release mode, press the release mode dial lock release and turn the release mode dial to the desired setting (☐ 57).

Release mode dial lock release



Release mode dial

Mode	Description
 S Single frame	One photograph is taken each time the shutter-release button is pressed.
 CL Continuous low speed	The camera takes photographs at a slow rate while the shutter-release button is pressed.
 CH Continuous high speed	The camera takes photographs at a fast rate while the shutter-release button is pressed.
 Q Quiet shutter-release	As for single-frame, except that camera noise is reduced.
 Self-timer	Take pictures with the self-timer.
 MUP Mirror up	Raise the mirror before taking photographs.



The Control Panel

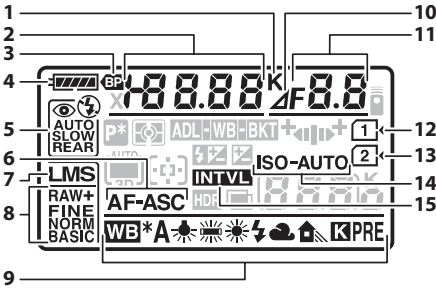

1	Color temperature indicator	94
2	Shutter speed	49, 51
	Exposure compensation value	86
	Flash compensation value	124
	White balance fine-tuning	92
	Color temperature	89, 94
	White balance preset number	95
	Number of shots in exposure and flash bracketing sequence	133
	Number of shots in WB bracketing sequence	137
	Number of intervals for interval timer photography	146
	Focal length (non-CPU lenses)	151

3	MB-D15 battery indicator	243
4	Battery indicator	35
5	Flash mode	120
6	Autofocus mode	71
7	Image size	68
8	Image quality	66
9	White balance	89
	White balance fine-tuning indicator	92
10	Aperture stop indicator	47, 298
11	Aperture (f-number)	50, 51
	Aperture (number of stops)	47, 298
	Bracketing increment	134, 138
	Number of shots in ADL bracketing sequence	139
	HDR mode	115
	Number of shots per interval	146
	Maximum aperture (non-CPU lenses)	151
	PC mode indicator	207
12	Memory card indicator (Slot 1)	31, 69
13	Memory card indicator (Slot 2)	31, 69
14	ISO sensitivity indicator	79
	Auto ISO sensitivity indicator	82
15	Interval timer indicator	147

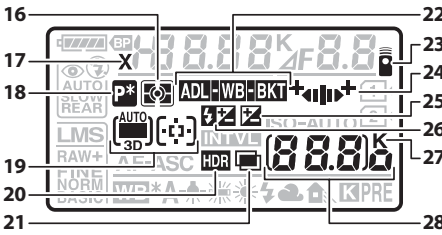

16	Metering	83
17	Flash sync indicator	244
18	Flexible program indicator	48
19	Auto-area AF indicator	73
	AF-area mode indicator	74
	3D-tracking indicator	73
20	HDR indicator	115
21	Multiple exposure indicator	142

22	Exposure and flash bracketing indicator	133
	WB bracketing indicator	137
	ADL bracketing indicator	139
23	Remote control mode (ML-L3)	127
24	Bracketing progress indicator	133, 137, 139
25	Exposure compensation indicator	86
26	Flash compensation indicator	124
27	"K" (appears when memory remains for over 1000 exposures)	35
28	Number of exposures remaining	35
	Number of shots remaining before memory buffer fills	37, 58, 348
	ISO sensitivity	239
	Preset white balance recording indicator	96
	Active D-Lighting amount	114
	HDR strength	116
	Manual lens number	151
	Capture mode indicator	207
	HDMI-CEC connection indicator	216

Note: Display shown with all indicators lit for illustrative purposes.

The Viewfinder

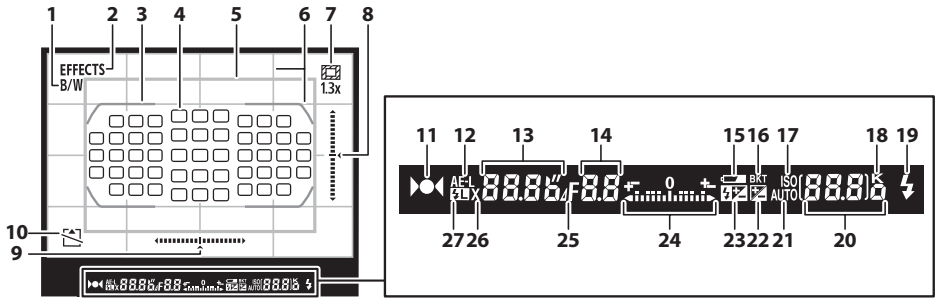

1	Monochrome indicator (displayed in mode or when the Monochrome Picture Control or a Picture Control based on Monochrome is selected)	105	17	ISO sensitivity indicator	79
2	Special effects mode indicator	177	18	"K" (appears when memory remains for over 1000 exposures)	35
3	AF area brackets	33, 37	19	Flash-ready indicator	38, 241
4	Focus points	37, 75, 232	20	Number of exposures remaining	35
	AF-area mode	73		Number of shots remaining before memory buffer fills	37, 58, 348
5	1.3× DX crop	64		ISO sensitivity	239
6	Framing grid (displayed when On is selected for Custom Setting d2)	239		Active D-Lighting amount	114
7	1.3× DX crop indicator	64		AF-area mode	73
8	Roll indicator (portrait orientation)	254		Preset white balance recording indicator	96
9	Roll indicator (landscape orientation)	254		Exposure compensation value	86
10	"No memory card" indicator	30		Flash compensation value	124
11	Focus indicator	37, 76, 78	21	Auto ISO sensitivity indicator	82
12	Autoexposure (AE) lock	84	22	Exposure compensation indicator	86
13	Shutter speed	49, 51	23	Flash compensation indicator	124
	Autofocus mode	71	24	Exposure indicator	51
14	Aperture (f-number)	50, 51		Exposure compensation display	86
	Aperture (number of stops)	47, 298	25	Aperture stop indicator	47, 298
15	Low battery warning	35	26	Flash sync indicator	244
16	Exposure and flash bracketing indicator	133	27	FV lock indicator	125
	WB bracketing indicator	137			
	ADL bracketing indicator	139			

Note: Display shown with all indicators lit for illustrative purposes.

No Battery

When the battery is totally exhausted or no battery is inserted, the display in the viewfinder will dim. This is normal and does not indicate a malfunction. The viewfinder display will return to normal when a fully-charged battery is inserted.

The Control Panel and Viewfinder Displays

The brightness of the control panel and viewfinder displays varies with temperature, and the response times of the displays may drop at low temperatures. This is normal and does not indicate a malfunction.

The Information Display

Press the **info** button to display shutter speed, aperture, the number of exposures remaining, AF-area mode, and other shooting information in the monitor.

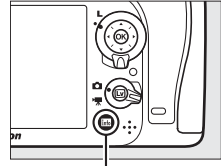

info button

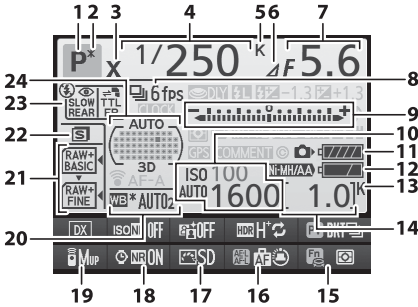

<table border="0"> <tr><td>1</td><td>Shooting mode</td><td>36, 41, 47, 177</td></tr> <tr><td>2</td><td>Flexible program indicator</td><td>48</td></tr> <tr><td>3</td><td>Flash sync indicator</td><td>244</td></tr> <tr><td>4</td><td>Shutter speed</td><td>49, 51</td></tr> <tr><td></td><td>Number of shots in exposure and flash bracketing sequence</td><td>133</td></tr> <tr><td></td><td>Number of shots in WB bracketing sequence</td><td>137</td></tr> <tr><td></td><td>Focal length (non-CPU lenses)</td><td>149</td></tr> <tr><td></td><td>Color temperature</td><td>89, 94</td></tr> <tr><td>5</td><td>Color temperature indicator</td><td>94</td></tr> <tr><td>6</td><td>Aperture stop indicator</td><td>47, 298</td></tr> <tr><td>7</td><td>Aperture (f-number)</td><td>50, 51</td></tr> <tr><td></td><td>Aperture (number of stops)</td><td>47, 298</td></tr> <tr><td></td><td>Bracketing increment</td><td>134, 138</td></tr> <tr><td></td><td>Number of shots in ADL bracketing sequence</td><td>139</td></tr> <tr><td></td><td>Maximum aperture (non-CPU lenses)</td><td>151</td></tr> </table>	1	Shooting mode	36, 41, 47, 177	2	Flexible program indicator	48	3	Flash sync indicator	244	4	Shutter speed	49, 51		Number of shots in exposure and flash bracketing sequence	133		Number of shots in WB bracketing sequence	137		Focal length (non-CPU lenses)	149		Color temperature	89, 94	5	Color temperature indicator	94	6	Aperture stop indicator	47, 298	7	Aperture (f-number)	50, 51		Aperture (number of stops)	47, 298		Bracketing increment	134, 138		Number of shots in ADL bracketing sequence	139		Maximum aperture (non-CPU lenses)	151	<table border="0"> <tr><td>8</td><td>Release mode</td><td>7, 57</td></tr> <tr><td></td><td>Continuous shooting speed</td><td>58, 239</td></tr> <tr><td>9</td><td>Exposure indicator</td><td>51</td></tr> <tr><td></td><td>Exposure compensation display</td><td>86</td></tr> <tr><td></td><td>Bracketing progress indicator</td><td></td></tr> <tr><td></td><td>Exposure and flash bracketing</td><td>133</td></tr> <tr><td></td><td>WB bracketing</td><td>137</td></tr> <tr><td>10</td><td>ISO sensitivity</td><td>79, 82</td></tr> <tr><td>11</td><td>Camera battery indicator</td><td>35</td></tr> <tr><td>12</td><td>MB-D15 battery type display</td><td>242</td></tr> <tr><td></td><td>MB-D15 battery indicator</td><td>243</td></tr> <tr><td>13</td><td>"K" (appears when memory remains for over 1000 exposures)</td><td>35</td></tr> <tr><td>14</td><td>Number of exposures remaining</td><td>35</td></tr> <tr><td></td><td>Manual lens number</td><td>151</td></tr> <tr><td>15</td><td>Fn button assignment</td><td>253</td></tr> <tr><td>16</td><td>AE-L/AF-L button assignment</td><td>256</td></tr> <tr><td>17</td><td>Picture Control</td><td>106</td></tr> <tr><td>18</td><td>Long exposure noise reduction</td><td>228</td></tr> <tr><td>19</td><td>Remote control mode (ML-L3)</td><td>127</td></tr> <tr><td>20</td><td>White balance</td><td>89</td></tr> <tr><td></td><td>White balance fine-tuning indicator</td><td>92</td></tr> <tr><td>21</td><td>Image quality</td><td>66</td></tr> <tr><td></td><td>Role played by card in Slot 2</td><td>69</td></tr> <tr><td>22</td><td>Image size</td><td>68</td></tr> <tr><td>23</td><td>Flash mode</td><td>120</td></tr> <tr><td>24</td><td>Auto-area AF indicator</td><td>73</td></tr> <tr><td></td><td>Focus points indicator</td><td>75</td></tr> <tr><td></td><td>AF-area mode indicator</td><td>74</td></tr> <tr><td></td><td>3D-tracking indicator</td><td>73</td></tr> </table>	8	Release mode	7, 57		Continuous shooting speed	58, 239	9	Exposure indicator	51		Exposure compensation display	86		Bracketing progress indicator			Exposure and flash bracketing	133		WB bracketing	137	10	ISO sensitivity	79, 82	11	Camera battery indicator	35	12	MB-D15 battery type display	242		MB-D15 battery indicator	243	13	"K" (appears when memory remains for over 1000 exposures)	35	14	Number of exposures remaining	35		Manual lens number	151	15	Fn button assignment	253	16	AE-L/AF-L button assignment	256	17	Picture Control	106	18	Long exposure noise reduction	228	19	Remote control mode (ML-L3)	127	20	White balance	89		White balance fine-tuning indicator	92	21	Image quality	66		Role played by card in Slot 2	69	22	Image size	68	23	Flash mode	120	24	Auto-area AF indicator	73		Focus points indicator	75		AF-area mode indicator	74		3D-tracking indicator	73
1	Shooting mode	36, 41, 47, 177																																																																																																																																			
2	Flexible program indicator	48																																																																																																																																			
3	Flash sync indicator	244																																																																																																																																			
4	Shutter speed	49, 51																																																																																																																																			
	Number of shots in exposure and flash bracketing sequence	133																																																																																																																																			
	Number of shots in WB bracketing sequence	137																																																																																																																																			
	Focal length (non-CPU lenses)	149																																																																																																																																			
	Color temperature	89, 94																																																																																																																																			
5	Color temperature indicator	94																																																																																																																																			
6	Aperture stop indicator	47, 298																																																																																																																																			
7	Aperture (f-number)	50, 51																																																																																																																																			
	Aperture (number of stops)	47, 298																																																																																																																																			
	Bracketing increment	134, 138																																																																																																																																			
	Number of shots in ADL bracketing sequence	139																																																																																																																																			
	Maximum aperture (non-CPU lenses)	151																																																																																																																																			
8	Release mode	7, 57																																																																																																																																			
	Continuous shooting speed	58, 239																																																																																																																																			
9	Exposure indicator	51																																																																																																																																			
	Exposure compensation display	86																																																																																																																																			
	Bracketing progress indicator																																																																																																																																				
	Exposure and flash bracketing	133																																																																																																																																			
	WB bracketing	137																																																																																																																																			
10	ISO sensitivity	79, 82																																																																																																																																			
11	Camera battery indicator	35																																																																																																																																			
12	MB-D15 battery type display	242																																																																																																																																			
	MB-D15 battery indicator	243																																																																																																																																			
13	"K" (appears when memory remains for over 1000 exposures)	35																																																																																																																																			
14	Number of exposures remaining	35																																																																																																																																			
	Manual lens number	151																																																																																																																																			
15	Fn button assignment	253																																																																																																																																			
16	AE-L/AF-L button assignment	256																																																																																																																																			
17	Picture Control	106																																																																																																																																			
18	Long exposure noise reduction	228																																																																																																																																			
19	Remote control mode (ML-L3)	127																																																																																																																																			
20	White balance	89																																																																																																																																			
	White balance fine-tuning indicator	92																																																																																																																																			
21	Image quality	66																																																																																																																																			
	Role played by card in Slot 2	69																																																																																																																																			
22	Image size	68																																																																																																																																			
23	Flash mode	120																																																																																																																																			
24	Auto-area AF indicator	73																																																																																																																																			
	Focus points indicator	75																																																																																																																																			
	AF-area mode indicator	74																																																																																																																																			
	3D-tracking indicator	73																																																																																																																																			

Note: Display shown with all indicators lit for illustrative purposes.

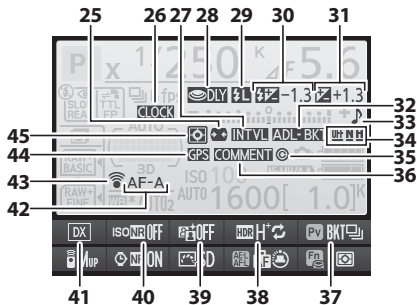



25	Auto distortion control.....	227
26	“Clock not set” indicator	29, 265
27	Interval timer indicator	147
28	Exposure delay mode	241
29	FV lock indicator	125
30	Flash compensation indicator	124
	Flash compensation value.....	124
31	Exposure compensation indicator.....	86
	Exposure compensation value	86

32	Exposure and flash bracketing indicator	133
	WB bracketing indicator	137
	ADL bracketing indicator.....	139
	Multiple exposure indicator.....	143
33	“Beep” indicator	238
34	ADL bracketing amount	139
35	Copyright information	267
36	Image comment indicator	266
37	Depth-of-field preview button assignment	255
38	HDR (high dynamic range).....	115
39	Active D-Lighting	114
40	High ISO noise reduction	228
41	Image area	64
42	Autofocus mode	71
43	Eye-Fi connection indicator.....	272
44	GPS connection indicator.....	152
45	Metering	83

Turning the Monitor Off

To clear shooting information from the monitor, press the  button or press the shutter-release button halfway. The monitor will turn off automatically if no operations are performed for about 10 seconds.

See Also

For information on choosing how long the monitor stays on, see Custom Setting c4 (**Monitor off delay**,  238). For information on changing the color of the lettering in the information display, see Custom Setting d8 (**Information display**,  241).



■ Changing Settings in the Information Display

To change settings for the items listed below, press the **i** button. Highlight items using the multi selector and press **OK** to view options for the highlighted item.

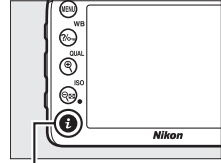

i button

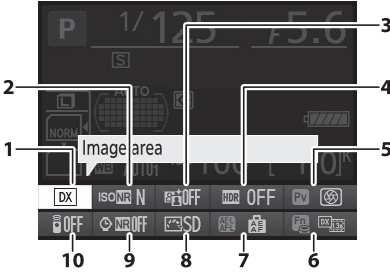

1	Image area.....	63
2	High ISO noise reduction.....	228
3	Active D-Lighting	113
4	HDR (high dynamic range).....	115
5	Depth-of-field preview button assignment.....	255
6	Fn button assignment	253
7	AE-L/AF-L button assignment.....	256
8	Picture Control	105
9	Long exposure noise reduction	228
10	Remote control mode (ML-L3)	127

Tool Tips

A tool tip giving the name of the selected item appears in the information display. Tool tips can be turned off using Custom Setting d4 (**Screen tips**;  239).



The Command Dials

The main- and sub-command dials are used alone or in combination with other controls to adjust a variety of settings.

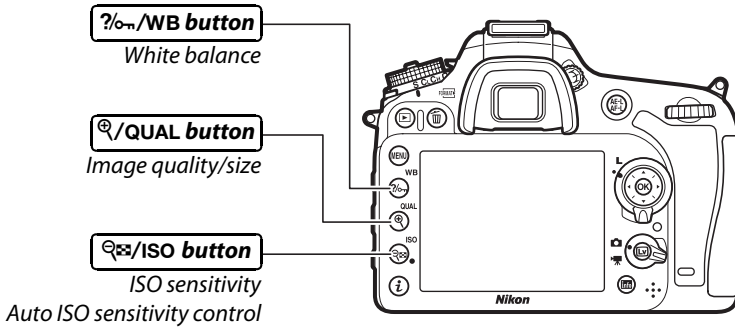
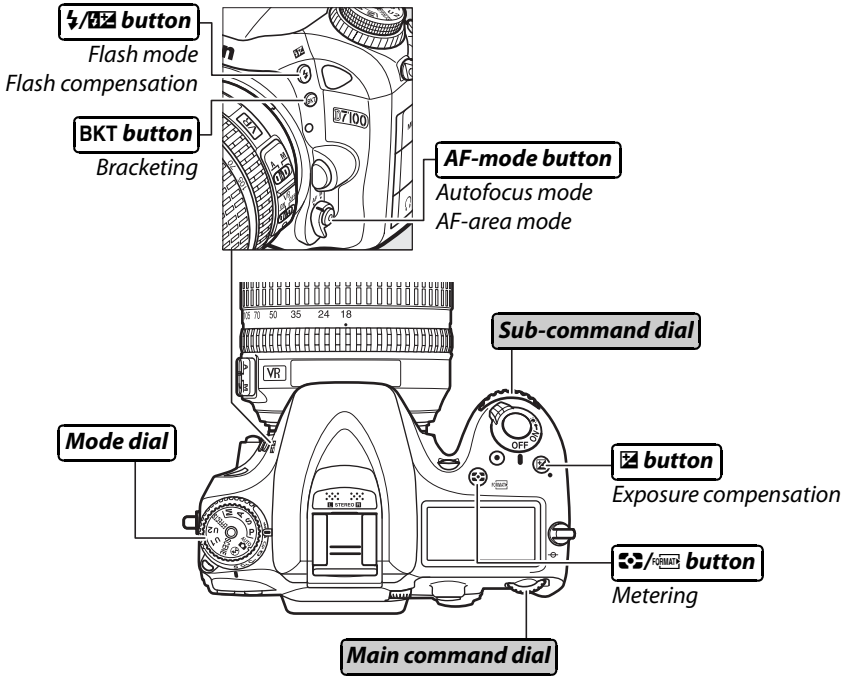

■ Scene and Special Effect Modes

Choose a scene (SCENE; 41).

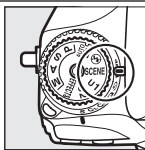

SCENE mode



Main command dial

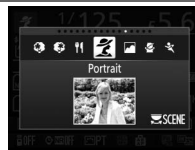

Monitor

Choose a special effect mode (EFFECTS; 177).

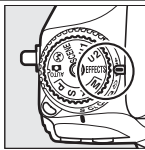

EFFECTS mode



Main command dial

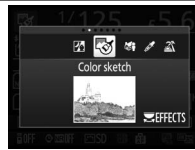

Monitor

■ Image Quality and Size

Set image quality (QUAL; 66).

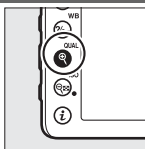

QUAL button



Main command dial

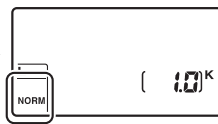

Control panel

Choose an image size (68).

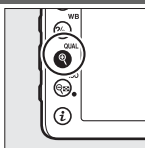

QUAL button

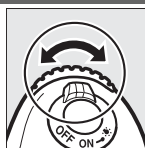

Sub-command dial

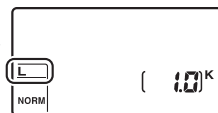

Control panel

■ Autofocus

Choose an autofocus mode (AF M; 72).

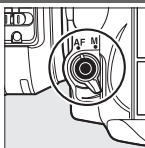

AF-mode button



Main command dial



Control panel

Choose an AF-area mode (74).

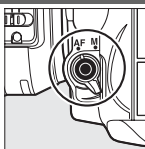

AF-mode button

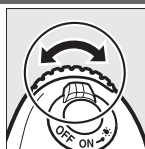

Sub-command dial



Control panel

■ ISO Sensitivity

Set ISO sensitivity (☐ 79).

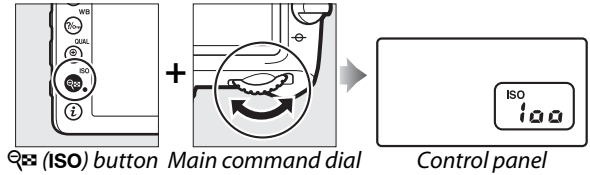

Set auto ISO sensitivity control (☐ 82).

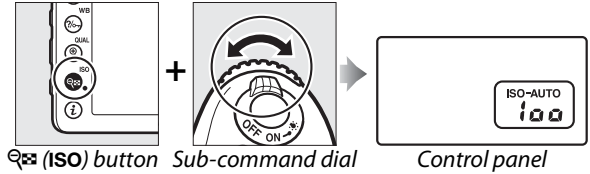

■ Exposure

Choose a combination of aperture and shutter speed (mode **P**; ☐ 48).

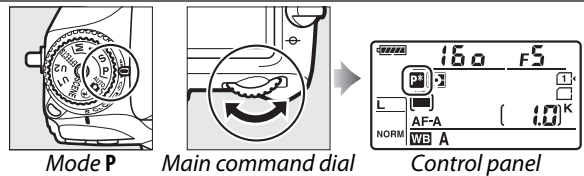

Choose a shutter speed (mode **S** or **M**; ☐ 49, 51).

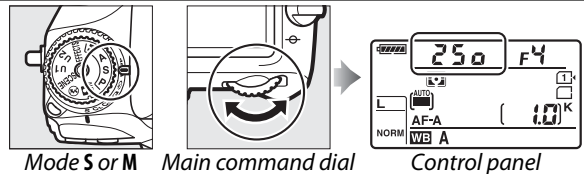

Choose an aperture (mode **A** or **M**; ☐ 50, 51).

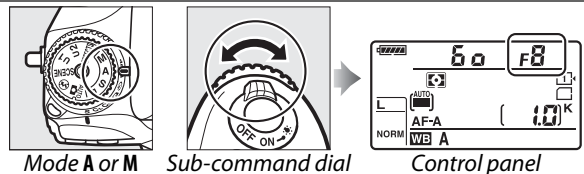

Choose a metering option (mode **P**, **S**, **A**, or **M**; ☐ 83).

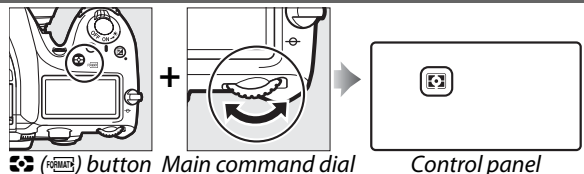

Set exposure compensation
(mode **P**, **S**, **A**, **M**, or ; 86).

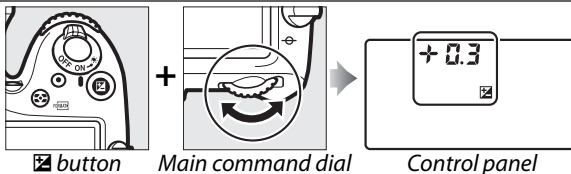

button

Main command dial

Control panel

Activate or cancel bracketing/
select number of shots in
bracketing sequence (mode **P**, **S**,
A, or **M**; 133).

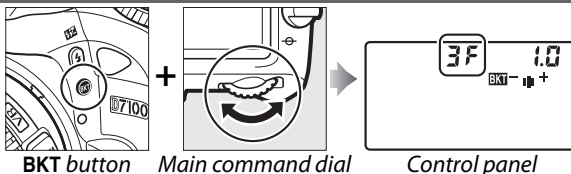

BKT button

Main command dial

Control panel

Select bracketing increment
(mode **P**, **S**, **A**, or **M**; 134).

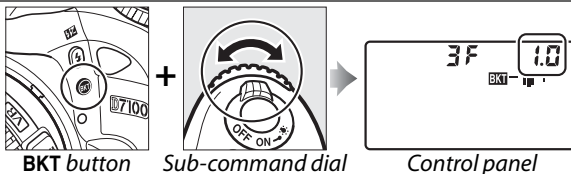

BKT button

Sub-command dial

Control panel

■ ■ White Balance

Choose a white balance option
(mode **P**, **S**, **A**, or **M**; 89).



(WB) button

Main command dial

Control panel

Fine-tune white balance (91),
set color temperature (94), or
choose a white balance preset
(95) in mode **P**, **S**, **A**, or **M**.



(WB) button

Sub-command dial

Control panel

Flash Settings

Choose a flash mode (📖 120).

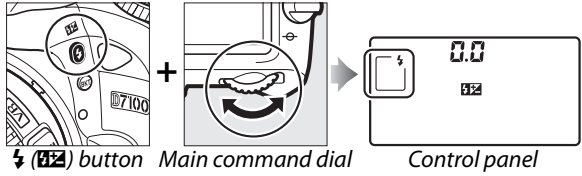

Set flash compensation (mode **P**, **S**, **A**, or **M**; 📖 124).

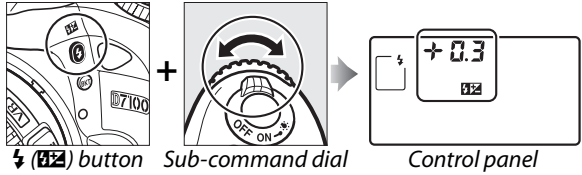

The *i* button

Use the *i* button for quick access to a variety of functions during viewfinder and live view photography, movie recording, and playback.

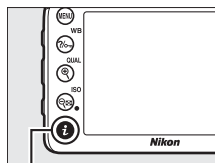

i button

■■ Viewfinder Photography

Press *i* to view links to frequently-used shooting options at the bottom of the information display (□ 12).



■■ Live View Photography/Movie Recording

Press *i* to display a list of the settings available during live view photography or movie recording (□ 157, 164).



■■ Playback

Pressing *i* during photo or movie playback displays retouch (□ 275) or movie edit (□ 173) options.

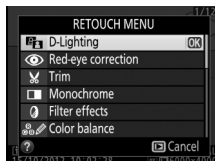

Camera Menus

Most shooting, playback, and setup options can be accessed from the camera menus. To view the menus, press the **MENU** button.

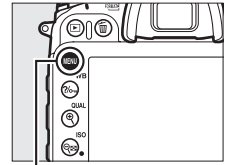

MENU button

Tabs

Choose from the following menus:

- : **Playback** (📖 217)
- : **Shooting** (📖 224)
- : **Custom Settings** (📖 229)
- : **Setup** (📖 261)
- : **Retouch** (📖 273)
- : **My Menu** or **Recent settings** (defaults to **My Menu**; 📖 291)

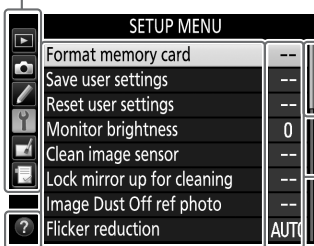

Slider shows position in current menu.

Current settings are shown by icons.

Menu options
Options in current menu.



If a icon is displayed at the bottom left corner of the monitor, help can be displayed by pressing the (WB) button. A description of the currently selected option or menu will be displayed while the button is pressed. Press or to scroll through the display.

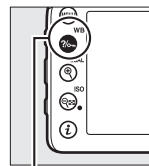

(WB) button

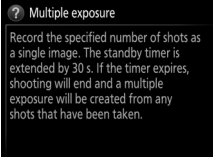

Using Camera Menu

The multi selector and **OK** button are used to navigate the camera menu.

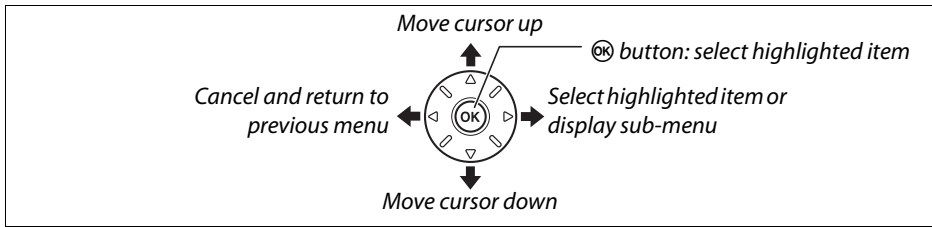

Follow the steps below to navigate the menu.

1 Display the menus.

Press the **MENU** button to display the menus.

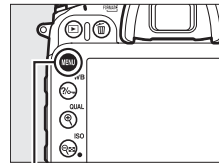

MENU button

2 Highlight the icon for the current menu.

Press **◀** to highlight the icon for the current menu.

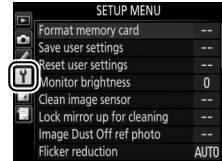

3 Select a menu.

Press **▲** or **▼** to select the desired menu.



4 Position the cursor in the selected menu.

Press **▶** to position the cursor in the selected menu.

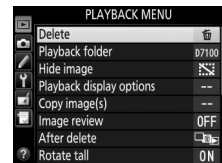

5 Highlight a menu item.

Press ▲ or ▼ to highlight a menu item.

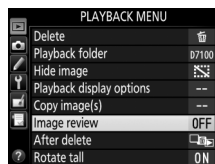

6 Display options.

Press ► to display options for the selected menu item.

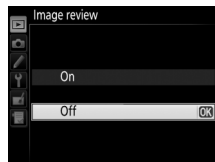

7 Highlight an option.

Press ▲ or ▼ to highlight an option.



8 Select the highlighted item.

Press **OK** to select the highlighted item. To exit without making a selection, press the **MENU** button.



Note the following:

- Menu items that are displayed in gray are not currently available.
- While pressing ► generally has the same effect as pressing **OK**, there are some cases in which selection can only be made by pressing **OK**.
- To exit the menus and return to shooting mode, press the shutter-release button halfway (□ 38).

First Steps

Charge the Battery

The camera is powered by an EN-EL15 rechargeable Li-ion battery (supplied). To maximize shooting time, charge the battery in the supplied MH-25 battery charger before use. About 2 hours and 35 minutes are required to fully recharge the battery when no charge remains.

1 Connect the AC power cable.

Connect the power cable. The AC adapter plug should be in the position shown at right; do not rotate.

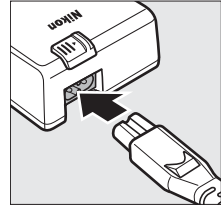

2 Remove the terminal cover.

Remove the terminal cover from the battery.

3 Insert the battery.

Place the battery in the battery bay as shown in the illustration on the charger.

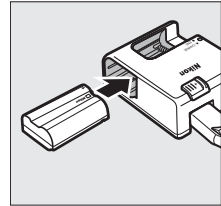

4 Plug the charger in.

The **CHARGE** lamp will flash slowly while the battery charges.

Charging the Battery

Charge the battery indoors at ambient temperatures between 5 °C–35 °C (41 °F–95 °F). The battery will not charge if its temperature is below 0 °C (32 °F) or above 60 °C (140 °F).

Battery charging *Charging complete*

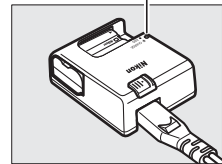
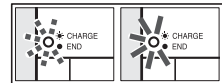

5 Remove the battery when charging is complete.

Charging is complete when the **CHARGE** lamp stops flashing. Unplug the charger and remove the battery.

The AC Wall Adapter

Depending on the country or region of purchase, an AC wall adapter may also be supplied with the charger. To use the adapter, insert it into the charger AC inlet (①). Slide the AC wall adapter latch in the direction shown (②) and rotate the adapter 90° to fix it in the position shown (③). Reverse these steps to remove the adapter.

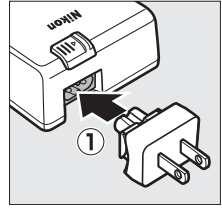

*AC wall adapter
latch*

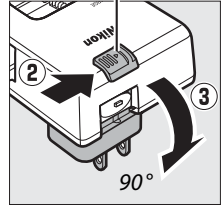

Insert the Battery

Before inserting the battery, rotate the power switch to **OFF**.

✓ Inserting and Removing Batteries

Always turn the camera off before inserting or removing batteries.

1 Open the battery-chamber cover.

Unlatch (①) and open (②) the battery-chamber cover.

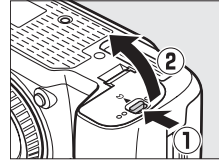

2 Insert the battery.

Insert the battery in the orientation shown (①), using the battery to keep the orange battery latch pressed to one side. The latch locks the battery in place when the battery is fully inserted (②).

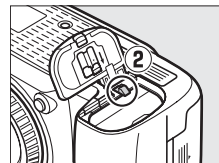
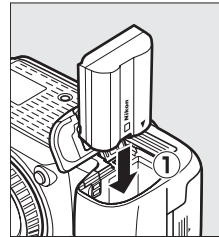

Battery latch

3 Close the battery-chamber cover.

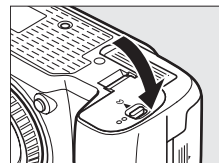

✓ Removing the Battery

Turn the camera off and open the battery-chamber cover. Press the battery latch in the direction shown by the arrow to release the battery and then remove the battery by hand.

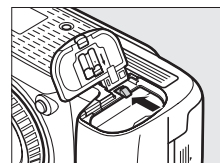

The Battery and Charger

Read and follow the warnings and cautions on pages xxi–xxii and 318–320 of this manual. Do not use the battery at ambient temperatures below 0 °C/32 °F or above 40 °C/104 °F; failure to observe this precaution could damage the battery or impair its performance. Capacity may be reduced and charging times may increase at battery temperatures from 0 °C/32 °F to 15 °C/59 °F and from 45 °C/113 °F to 60 °C/140 °F.

If the **CHARGE** lamp flashes quickly (about eight times a second) during charging, confirm that the temperature is in the correct range and then unplug the charger and remove and reinsert the battery. If the problem persists, cease use immediately and take battery and charger to your retailer or a Nikon-authorized service representative.

Do not short the charger terminals; failure to observe this precaution could result in overheating and damage to the charger. Do not move the charger or touch the battery during charging. Failure to observe this precaution could in very rare instances result in the charger showing that charging is complete when the battery is only partially charged. Remove and reinsert the battery to begin charging again. Battery capacity may temporarily drop if the battery is charged at low temperatures or used at a temperature below the temperature at which it was charged. If the battery is charged at a temperature below 5 °C (41 °F), the battery life indicator in the **Battery info** (□ 266) display may show a temporary decrease.

The battery may be hot immediately after use. Wait for the battery to cool before recharging.

The supplied power cable and AC wall adapter are for use with the MH-25 only. Use the charger with compatible batteries only. Unplug when not in use.

A marked drop in the time a fully charged battery retains its charge when used at room temperature indicates that it requires replacement. Purchase a new EN-EL15 battery.

EN-EL15 Rechargeable Li-ion Batteries

The supplied EN-EL15 shares information with compatible devices, enabling the camera to show battery charge state in six levels (□ 35). The **Battery info** option in the setup menu details battery charge, battery life, and the number of pictures taken since the battery was last charged (□ 266).



Attach a Lens

The lens generally used in this manual for illustrative purposes is an AF-S DX NIKKOR 18-105mm f/3.5-5.6G ED VR.

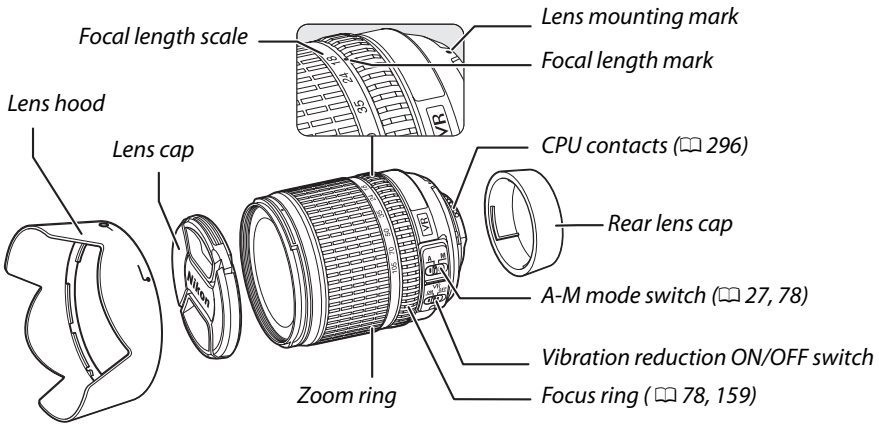

Care should be taken to prevent dust from entering the camera when the lens is removed.

1 Turn the camera off.

2 Remove the rear lens cap and the camera body cap.

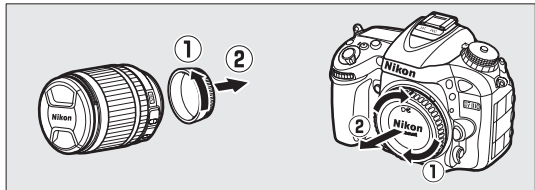

3 Attach the lens.

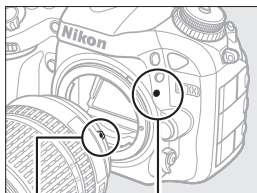

Mounting mark
(camera)

Mounting mark (lens)

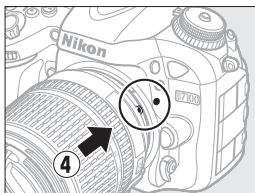

Keeping marks (indicated by white dot) aligned, position lens on camera, then rotate until lens clicks into place.

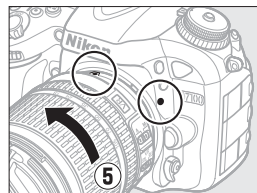

If the lens is equipped with an **A-M** or **M/A-M** mode switch, select **A** (autofocus) or **M/A** (autofocus with manual override).

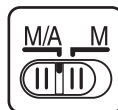

Detaching the Lens

Be sure the camera is off when removing or exchanging lenses. To remove the lens, press and hold the lens release button (①) while turning the lens clockwise (②). After removing the lens, replace the lens caps and camera body cap.

CPU Lenses with Aperture Rings

In the case of CPU lenses equipped with an aperture ring (☐ 296), lock aperture at the minimum setting (highest f-number).

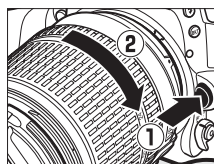

Basic Setup

A language-selection dialog will be displayed the first time the camera is turned on. Choose a language and set the time and date. Photographs can not be taken until you have set the time and date.

1 Turn the camera on.

A language-selection dialog will be displayed.

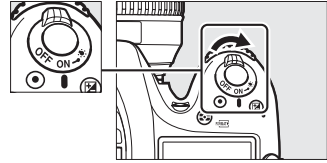

2 Choose a language and set the camera clock.

Use the multi selector and **OK** button to select a language and set the camera clock.

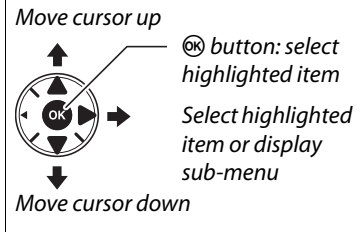

Select language



Select time zone



Select date format

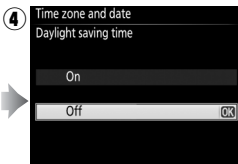

Select daylight saving time option

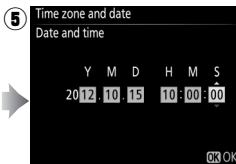

Set time and date
(note that the camera uses a 24-hour clock)

Note: The language and date/time can be changed at any time using the **Language and Time zone and date** options in the setup menu (265).

The Clock Battery

The camera clock is powered by an independent, rechargeable power source, which is charged as necessary when the main battery is installed or the camera is powered by an optional EP-5B power connector and EH-5b AC adapter (□ 308). Two days of charging will power the clock for about three months. If the camera displays a warning at startup stating that the clock is not set and a  icon flashes in the information display, the clock battery is exhausted and the clock has been reset. Set the clock to the correct time and date.

The Camera Clock

The camera clock is less accurate than most watches and household clocks. Check the clock regularly against more accurate time pieces and reset as necessary. The camera clock can also be synchronized with GPS devices (□ 152).



Insert a Memory Card

The camera stores pictures on Secure Digital (SD) memory cards (available separately; □ 347). To install a memory card, turn the camera off and, holding the card in the orientation shown below, slide it in until it clicks into place. The memory card access lamp will light for a few seconds. Note that the camera has two memory card slots (Slot 1 and Slot 2); if you will be using only one memory card, insert it in Slot 1.

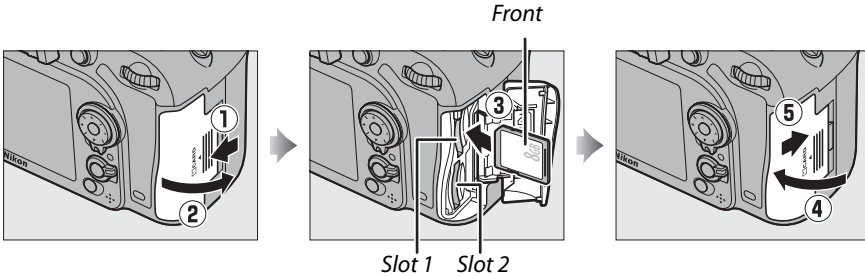

Format memory cards before first use or after they have been used in other devices (□ 32).

Inserting memory cards upside down or backwards could damage the camera or the card. Check to be sure the card is in the correct orientation. The card slot cover will not close if the card is not correctly inserted.

Removing Memory Cards

After confirming that the memory card access lamp is off, turn the camera off, open the memory card slot cover, and press the card in to eject it (①). The card can then be removed by hand (②).

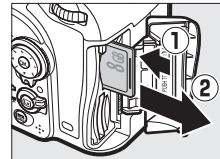

No Memory Card

If the camera is turned off with a charged EN-EL15 battery and no memory card inserted, (- E -) will be displayed in the control panel and viewfinder.

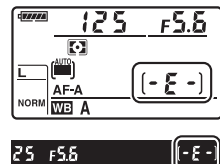

✓ Memory Cards

- Memory cards may be hot after use. Observe due caution when removing memory cards from the camera.
- Turn the power off before inserting or removing memory cards. Do not remove memory cards from the camera, turn the camera off, or remove or disconnect the power source during formatting or while data are being recorded, deleted, or copied to a computer. Failure to observe these precautions could result in loss of data or in damage to the camera or card.
- Do not touch the card terminals with your fingers or metal objects.
- Do not bend, drop, or subject to strong physical shocks.
- Do not apply force to the card casing. Failure to observe this precaution could damage the card.
- Do not expose to water, heat, high levels of humidity, or direct sunlight.
- Do not format memory cards in a computer.

✎ Using Two Memory Cards

Slot 1 is for the main card; the card in slot 2 plays a backup or secondary role. If the default setting of **Overflow** is selected for **Role played by card in Slot 2** (📖 69) when two memory cards are inserted, the card in slot 2 will only be used when the card in slot 1 is full.

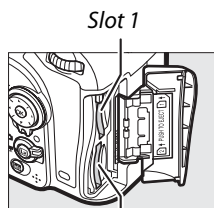

The control panel shows the slot or slots that currently hold a memory card (the example at right shows the icons displayed when a card is inserted in each slot). If the memory card is full or locked or an error has occurred, the icon for the affected card will flash (📖 334).

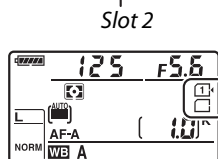

Control panel

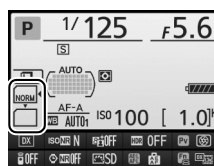

Information display

✎ The Write Protect Switch

SD memory cards are equipped with a write protect switch to prevent accidental loss of data. When this switch is in the “lock” position, the memory card can not be formatted and photos can not be deleted or recorded (a warning will be displayed in the monitor if you attempt to release the shutter). To unlock the memory card, slide the switch to the “write” position.

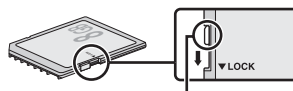

Write-protect switch



Format the Memory Card





Memory cards must be formatted before first use or after being used or formatted in other devices.

✓ Formatting Memory Cards



Formatting memory cards permanently deletes any data they may contain. Be sure to copy any photographs and other data you wish to keep to a computer before proceeding (☞ 203).

1 Turn the camera on.

2 Press the (FORMAT) and (FORMAT) buttons.

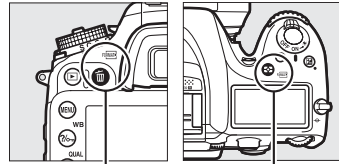

Hold the  (FORMAT) and  (FORMAT) buttons down simultaneously until a flashing **F a r** (format) appears in the shutter-speed displays in the control panel and viewfinder. If two memory cards are inserted, the card in Slot 1 (☞ 31) will be selected; you can choose the card in Slot 2 by rotating the main command dial. To exit without formatting the memory card, wait until **F a r** stops flashing (about six seconds) or press any button other than the  (FORMAT) and  (FORMAT) buttons.

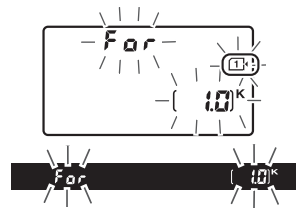

 button  button



3 Press the (FORMAT) and (FORMAT) buttons again.

Press the  (FORMAT) and  (FORMAT) buttons together a second time while **F a r** is flashing to format the memory card. *Do not remove the memory card or remove or disconnect the power source during formatting.*

When formatting is complete, the control panel and viewfinder will show the number of photographs that can be recorded at current settings.

✍ See Also

See page 262 for information on formatting memory cards using the **Format memory card** option in the setup menu.

Adjust Viewfinder Focus

The camera is equipped with diopter adjustment to accommodate individual differences in vision. Check that the display in the viewfinder is in focus before framing pictures in the viewfinder.

1 Turn the camera on.

Remove the lens cap and turn the camera on.



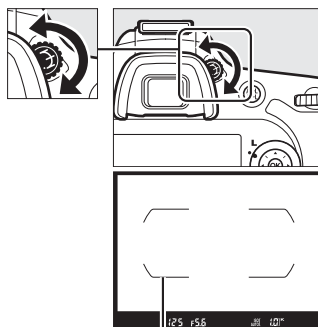

2 Focus the viewfinder.

Rotate the diopter adjustment control until the AF area brackets are in sharp focus. When operating the diopter adjustment control with your eye to the viewfinder, be careful not to put your fingers or fingernails in your eye.



AF area brackets

Adjusting Viewfinder Focus

If you are unable to focus the viewfinder as described above, select single-servo autofocus (AF-S; ) 71), single-point AF () 73), and the center focus point () 75), and then frame a high-contrast subject in the center focus point and press the shutter-release button halfway to focus the camera. With the camera in focus, use the diopter adjustment control to bring the subject into clear focus in the viewfinder. If necessary, viewfinder focus can be further adjusted using optional corrective lenses () 308).





Basic Photography and Playback

Battery Level and Card Capacity

Before shooting, check the battery level and number of exposures remaining.

1 Turn the camera on.

Remove the lens cap and turn the camera on. The control panel will turn on and the display in the viewfinder will light.

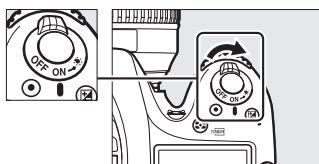

2 Check the battery level.

Check the battery level in the control panel or viewfinder.

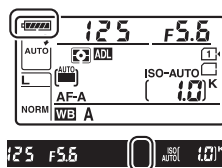

Control panel	Viewfinder	Description
	—	Battery fully charged.
	—	Battery partially discharged.
	—	
		Low battery. Charge battery or ready spare battery.
(flashes)	(flashes)	Shutter release disabled. Charge or exchange battery.

3 Check the number of exposures remaining.

The control panel and viewfinder show the number of photographs that can be taken at current settings (values over 1000 are rounded down to the nearest hundred; e.g., values between 1000 and 1099 are shown as 1.0 K). If two memory cards are inserted, the displays show the space available on the card in Slot 1 (□ 31). When the number of exposures remaining reaches , the number will flash, **F** or **F** will flash in the shutter-speed displays, and the icon for the affected card will flash. Insert another memory card (□ 30) or delete some photos (□ 40, 197).

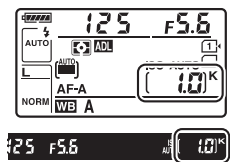



Image Sensor Cleaning

The camera vibrates the image sensor to remove dust when the camera is turned on or off (□ 313).

“Point-and-Shoot” Photography

(^{AUTO} and Modes)

This section describes how to take photographs in ^{AUTO} and  modes, an automatic “point-and-shoot” mode in which the majority of settings are controlled by the camera in response to shooting conditions.



1 Select ^{AUTO} or Mode.

To shoot where use of a flash is prohibited, photograph infants, or capture natural lighting under low light, select auto (flash off) mode by rotating the mode dial to . Otherwise, rotate the dial to ^{AUTO} (auto).

Mode dial

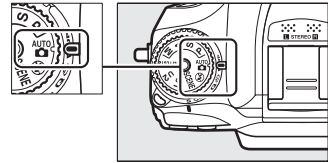

2 Ready the camera.

When framing photographs in the viewfinder, hold the handgrip in your right hand and cradle the camera body or lens with your left. Keep your elbows propped lightly against your torso for support and place one foot half a pace ahead of the other to keep your upper body stable. When framing photographs in portrait (tall) orientation, hold the camera as shown in the bottom of the three illustrations at right.

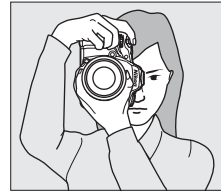
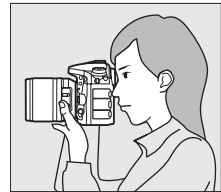
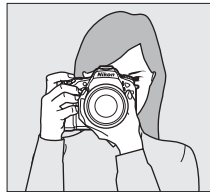

In  mode, shutter speeds slow when lighting is poor; use of a tripod is recommended.

Using a Zoom Lens

Use the zoom ring to zoom in on the subject so that it fills a larger area of the frame, or zoom out to increase the area visible in the final photograph (select longer focal lengths on the lens focal length scale to zoom in, shorter focal lengths to zoom out).

Zoom in

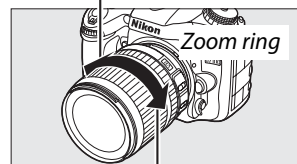

Zoom out

3 Frame the photograph.

Frame a photograph in the viewfinder with the main subject in the AF area brackets.



AF area brackets

4 Press the shutter-release button halfway.

Press the shutter-release button halfway to focus. The active focus point will be displayed. If the subject is poorly lit, the flash may pop up and the AF-assist illuminator may light.



5 Check the indicators in the viewfinder.

When the focus operation is complete, the in-focus indicator (●) will appear in the viewfinder.

In-focus indicator	Description
●	Subject in focus.
▶	Focus point is between camera and subject.
◀	Focus point is behind subject.
▶◀ (flashes)	Camera unable to focus using autofocus. See page 72.

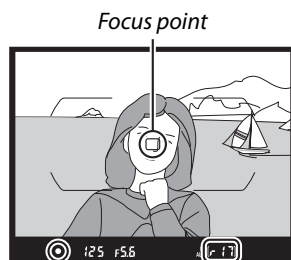

In-focus indicator

Buffer capacity

While the shutter-release button is pressed halfway, the number of exposures that can be stored in the memory buffer ("⚡"; 58) will be displayed in the viewfinder.

6 Shoot.

Smoothly press the shutter-release button the rest of the way down to release the shutter and record the photograph. The memory card access lamp next to the memory card slot cover will light while the photograph is being recorded to the memory card. *Do not eject the memory card or remove or disconnect the power source until the lamp has gone out and recording is complete.*

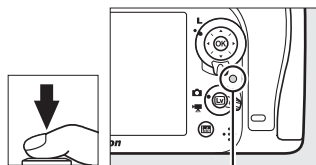

Memory card access lamp

The Shutter-Release Button

The camera has a two-stage shutter-release button. The camera focuses when the shutter-release button is pressed halfway. To take the photograph, press the shutter-release button the rest of the way down.



Focus: press halfway

Shoot: press all the way down

The Standby Timer

The viewfinder and the control panel shutter speed and aperture displays will turn off if no operations are performed for about 6 seconds, reducing the drain on the battery. Press the shutter-release button halfway to reactivate the display. The length of time before the standby timer expires automatically can be selected using Custom Setting c2 (**Standby timer**,  237).

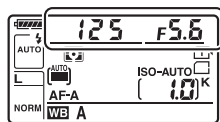
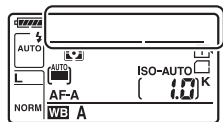
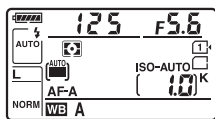

Exposure meters on

Exposure meters off

Exposure meters on

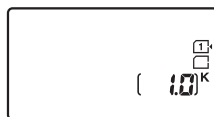

Camera Off Display

If the camera is turned off with a battery and memory card inserted, the memory card icon and number of exposures remaining will be displayed (some memory cards may in rare cases only display this information when the camera is on).



Control panel

The Built-in Flash

If additional lighting is required for correct exposure in  mode, the built-in flash will pop up automatically when the shutter-release button is pressed halfway. If the flash is raised, photographs can only be taken when the flash-ready indicator () is displayed. If the flash-ready indicator is not displayed, the flash is charging; remove your finger briefly from the shutter-release button and try again.

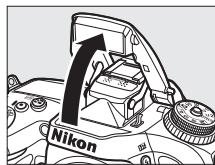

To save power when the flash is not in use, press it gently downward until the latch clicks into place.

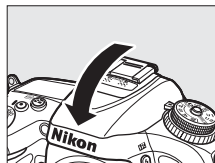

Basic Playback





1 Press the button.

A photograph will be displayed in the monitor. The memory card containing the picture currently displayed is shown by an icon.



 button

2 View additional pictures.

Additional pictures can be displayed by pressing  or . To view additional information on the current photograph, press  and  ([187](#)).

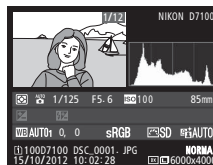

To end playback and return to shooting mode, press the shutter-release button halfway.



Image Review

When **On** is selected for **Image review** in the playback menu ([222](#)), photographs are automatically displayed in the monitor for a few seconds after shooting.

See Also

See page 186 for information on choosing a memory card slot.

Deleting Unwanted Photographs

To delete the photograph currently displayed in the monitor, press the  (FORMAT) button.



Note that photographs can not be recovered once deleted.

1 Display the photograph.

Display the photograph you wish to delete as described on the preceding page. The location of the current image is shown by an icon at the bottom left corner of the display.



2 Delete the photograph.

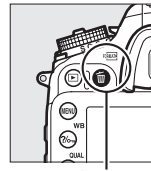

Press the  (FORMAT) button. A confirmation dialog will be displayed; press the  (FORMAT) button again to delete the image and return to playback. To exit without deleting the picture, press .

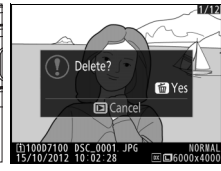

 (FORMAT) button



Delete

To delete selected images ( 198), all images taken on a selected date ( 199), or all images in a chosen location on a selected memory card ( 198), use the **Delete** option in the playback menu.

Creative Photography (Scene Modes)

The camera offers a choice of “scene” modes. Choosing a scene mode automatically optimizes settings to suit the selected scene, making creative photography as simple as selecting a mode, framing a picture, and shooting as described on pages 36–38.



■ SCENE Mode

To view the currently selected scene, rotate the mode dial to **SCENE** and press the **info** button. To choose another scene, rotate the main command dial.

Mode dial

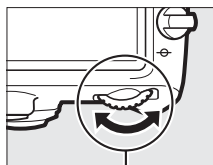
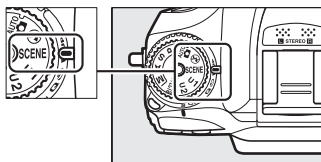

Main command dial

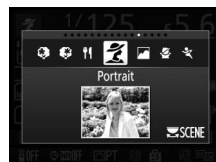

Monitor



Portrait



Use for portraits with soft, natural-looking skin tones. If the subject is far from the background or a telephoto lens is used, background details will be softened to lend the composition a sense of depth.

Landscape



Use for vivid landscape shots in daylight. The built-in flash and AF-assist illuminator turn off; use of a tripod is recommended to prevent blur when lighting is poor.

Child



Use for snapshots of children. Clothing and background details are vividly rendered, while skin tones remain soft and natural.

Sports



Fast shutter speeds freeze motion for dynamic sports shots in which the main subject stands out clearly. The built-in flash and AF-assist illuminator turn off. To take a sequence of shots, select continuous release mode (□ 7, 57).

Close Up



Use for close-up shots of flowers, insects, and other small objects (a macro lens can be used to focus at very close ranges). Use of a tripod is recommended to prevent blur.

Night Portrait



Use for a natural balance between the main subject and the background in portraits taken under low light. Use of a tripod is recommended to prevent blur when lighting is poor.

 **Night Landscape**



Reduce noise and unnatural colors when photographing night landscapes, including street lighting and neon signs. The built-in flash and AF-assist illuminator turn off; use of a tripod is recommended to prevent blur.

 **Beach/Snow**



Capture the brightness of sunlight expanses of water, snow, or sand. The built-in flash and AF-assist illuminator turn off.

 **Party/Indoor**



Capture the effects of indoor background lighting. Use for parties and other indoor scenes.

 **Sunset**



Preserves the deep hues seen in sunsets and sunrises. The built-in flash and AF-assist illuminator turn off; use of a tripod is recommended to prevent blur when lighting is poor.



Dusk/Dawn



Preserves the colors seen in the weak natural light before dawn or after sunset. The built-in flash and AF-assist illuminator turn off; use of a tripod is recommended to prevent blur when lighting is poor.

Candlelight



For photographs taken by candlelight. The built-in flash turns off; use of a tripod is recommended to prevent blur when lighting is poor.

Pet Portrait



Use for portraits of active pets. The AF-assist illuminator turns off.

Blossom



Use for fields of flowers, orchards in bloom, and other landscapes featuring expanses of blossoms. The built-in flash turns off; use of a tripod is recommended to prevent blur when lighting is poor.

Autumn Colors



Captures the brilliant reds and yellows in autumn leaves. The built-in flash turns off; use of a tripod is recommended to prevent blur when lighting is poor.

Food



Use for vivid photographs of food. Use of a tripod is recommended to prevent blur; the flash can also be used ( 119).





P, S, A, and M Modes

P, S, A, and M modes offer different degrees of control over shutter speed and aperture.



Mode	Description
P	Programmed auto (☞ 48): Camera sets shutter speed and aperture for optimal exposure. Recommended for snapshots and in other situations in which there is little time to adjust camera settings.
S	Shutter-priority auto (☞ 49): User chooses shutter speed; camera selects aperture for best results. Use to freeze or blur motion.
A	Aperture-priority auto (☞ 50): User chooses aperture; camera selects shutter speed for best results. Use to blur background or bring both foreground and background into focus.
M	Manual (☞ 51): User controls both shutter speed and aperture. Set shutter speed to Bulb (b u 1 b) or Time (- -) for long time-exposures.

Lens Types

When using a CPU lens equipped with an aperture ring (☞ 296), lock the aperture ring at the minimum aperture (highest f-number). Type G lenses are not equipped with an aperture ring.

Non-CPU lenses can only be used in modes **A** (aperture-priority auto) and **M** (manual), when aperture can only be adjusted using the lens aperture ring. Selecting any other mode disables the shutter release.

Non-CPU Lenses (☞ 295)

Use the lens aperture ring to adjust aperture. If the maximum aperture of the lens has been specified using the **Non-CPU lens data** item in setup menu (☞ 149) when a non-CPU lens is attached, the current f-number will be displayed in the viewfinder and control panel, rounded to the nearest full stop. Otherwise the aperture displays will show only the number of stops (ΔF , with maximum aperture displayed as $\Delta F0$) and the f-number must be read from the lens aperture ring.

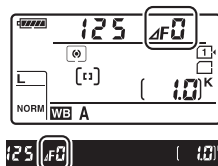

P: Programmed Auto

In this mode, the camera automatically adjusts shutter speed and aperture according to a built-in program to ensure optimal exposure in most situations. This mode is recommended for snapshots and other situations in which you want to leave the camera in charge of shutter speed and aperture.



PS
AM

Flexible Program

In mode **P**, different combinations of shutter speed and aperture can be selected by rotating the main command dial while the exposure meters are on (“flexible program”). Rotate the dial to the right for large apertures (low f-numbers) that blur background details or fast shutter speeds that “freeze” motion. Rotate the dial to the left for small apertures (high f-numbers) that increase depth of field or slow shutter speeds that blur motion. All combinations produce the same exposure. While flexible program is in effect, a **P*** indicator appears in the control panel. To restore default shutter speed and aperture settings, rotate the main command dial until the indicator is no longer displayed, choose another mode, or turn the camera off.

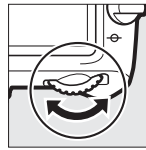

Main command dial

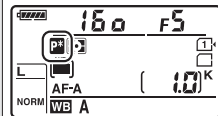

The Shutter Speed and Aperture Displays

The shutter speed and aperture displays can be activated by pressing the shutter-release button halfway to start the standby timer (□ 38).

See Also

See page 327 for information on the built-in exposure program.

S: Shutter-Priority Auto

In shutter-priority auto, you choose the shutter speed while the camera automatically selects the aperture that will produce the optimal exposure. Use slow shutter speeds to suggest motion by blurring moving subjects, fast shutter speeds to “freeze” motion.



Fast shutter speed ($1/1600$ s)

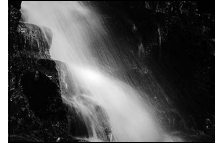

Slow shutter speed ($1/6$ s)

To choose a shutter speed, rotate the main command dial while the exposure meters are on. Shutter speed can be set to “x 250” or to values between 30 s and $1/8000$ s.

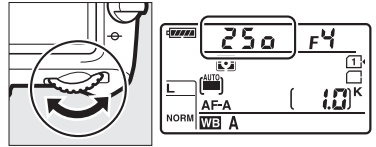

Main command dial

PS
AM

See Also

See page 333 for information on what to do if flashing Bulb (b u l b) or Time (- -) indicators appear in the shutter-speed displays.

A: Aperture-Priority Auto

In aperture-priority auto, you choose the aperture while the camera automatically selects the shutter speed that will produce the optimal exposure. Large apertures (low f-numbers) increase flash range (☐ 123) and reduce depth of field, blurring objects behind and in front of the main subject. Small apertures (high f-numbers) increase depth of field, bringing out details in the background and foreground. Short field depths are generally used in portraits to blur background details, long field depths in landscape photographs to bring the foreground and background into focus.



Large aperture (f/5.6)



Small aperture (f/22)

To choose an aperture between the minimum and maximum values for the lens, rotate the sub-command dial while the exposure meters are on.

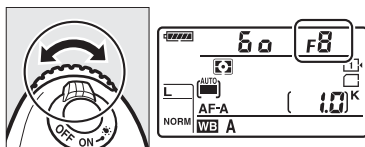

Sub-command dial

Depth-of-Field Preview

To preview the effects of aperture, press and hold the depth-of-field preview button. The lens will be stopped down to the current aperture value, allowing depth of field to be previewed in the viewfinder.

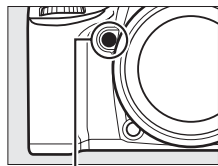

Depth-of-field preview button

Custom Setting e5—Modeling Flash

This setting controls whether the built-in flash and optional flash units such as the SB-910, SB-900, SB-800, SB-700, and SB-600 (☐ 304) will emit a modeling flash when the depth-of-field preview button is pressed. See page 251 for more information.

M: Manual

In manual mode, you control both shutter speed and aperture. While the exposure meters are on, rotate the main command dial to choose a shutter speed, and the sub-command dial to set aperture. Shutter speed can be set to "x 250" or to values between 30 s and 1/8000 s, or the shutter can be held open indefinitely for a long time-exposure (Bulb/bulb or Time/- -, 52). Aperture can be set to values between the minimum and maximum values for the lens. Use the exposure indicators to check exposure.



Shutter speed



Main command dial

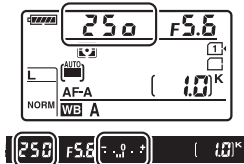

Aperture

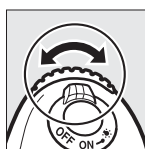

Sub-command dial

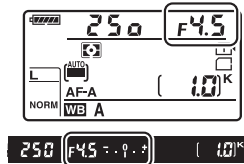

PS
AM

AF Micro NIKKOR Lenses

Provided that an external exposure meter is used, the exposure ratio need only be taken into account when the lens aperture ring is used to set aperture.

The Exposure Indicator

If a shutter speed other than Bulb (bulb) or Time (- -) is selected, the exposure indicator in the viewfinder shows whether the photograph would be under- or over-exposed at current settings. Depending on the option chosen for Custom Setting b2 (**EV steps for exposure ctrl**, 234), the amount of under- or over-exposure is shown in increments of 1/3 EV or 1/2 EV (the illustrations below show the display in the viewfinder when **1/3 step** is selected for Custom Setting b2). If the limits of the exposure metering or live view exposure control system are exceeded, the indicator will flash.

Optimal exposure	Underexposed by 1/3 EV	Overexposed by over 2 EV
- . 0 . +	- . 0 . +	- . 0 . +

See Also

For information reversing the exposure indicators so that negative values are displayed on the right and positive values on the left, see Custom Setting f8 (**Reverse indicators**, 258).

■ ■ Long Time-Exposures (M Mode Only)

Select the following shutter speeds for long time-exposures of moving lights, the stars, night scenery, or fireworks.

- **Bulb** (Ⓛ Ⓜ Ⓛ Ⓜ): The shutter remains open while the shutter-release button is held down. To prevent blur, use a tripod or an optional wireless remote controller (☐ 309) or remote cord (☐ 310).
- **Time** (- -): Start the exposure by using the shutter-release button on the camera or on an optional remote control, remote cord, or wireless remote controller. The shutter remains open for thirty minutes or until the button is pressed a second time.



Length of exposure: 35 s
Aperture: f/25

PS
AM

1 Ready the camera.

Mount the camera on a tripod or place it on a stable, level surface. To prevent light entering via the viewfinder interfering with exposure, remove the rubber eyecup and cover the viewfinder with the supplied DK-5 eyepiece cap (☐ 60). To prevent loss of power before the exposure is complete, use a fully charged EN-EL15 battery or an optional EH-5b AC adapter and EP-5B power connector. Note that noise (bright spots, randomly-spaced bright pixels, or fog) may be present in long exposures; before shooting, choose **On** for **Long exposure NR** in the shooting menu (☐ 228). If you will be using an ML-L3 remote control, select a remote control mode (**Delayed remote**, **Quick-response remote**, or **Remote mirror-up**) using the **Remote control mode (ML-L3)** option in the shooting menu (☐ 127).

2 Rotate the mode dial to M.

Mode dial

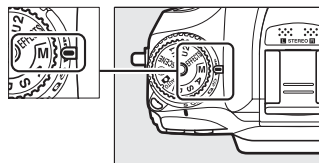

3 Choose a shutter speed.

While the exposure meters are on, rotate the main command dial to choose a shutter speed of Bulb (**b u l b**) or Time (**- -**).



Main
command dial

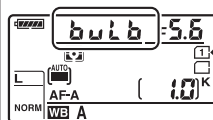

Bulb

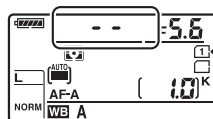

Time

4 Open the shutter.

Bulb: After focusing, press the shutter-release button on the camera or optional WR-1, WR-T10, or MC-DC2 all the way down. Keep the shutter-release button pressed until the exposure is complete.

Time: Press the shutter-release button on the camera or optional remote control, remote cord, or wireless remote controller all the way down. If the exposure is started by pressing the shutter-release button on the optional ML-L3 remote control, pictures are taken in "Time" (- -) mode even when "Bulb" (**b u l b**) is selected for shutter speed.

5 Close the shutter.

Bulb: Take your finger off the shutter-release button.

Time: Repeat the operation performed in Step 4. Shooting ends automatically after thirty minutes.



User Settings: U1 and U2 Modes

Assign frequently-used settings to the **U1** and **U2** positions on the mode dial.

Saving User Settings

1 Select a mode.

Rotate the mode dial to the desired mode.

Mode dial

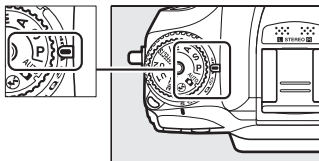

2 Adjust settings.

Make the desired adjustments to flexible program (mode **P**), shutter speed (modes **S** and **M**), aperture (modes **A** and **M**), exposure and flash compensation, flash mode, focus point, metering, autofocus and AF-area modes, bracketing, and settings in the shooting (□ 224) and Custom Settings (□ 229) menus (note that the camera will not store the options selected for **Storage folder**, **File naming**, **Image area**, **Manage Picture Control**, **Remote control mode (ML-L3)**, **Multiple exposure**, or **Interval timer shooting**).

3 Select Save user settings.

Press the **MENU** button to display the menus. Highlight **Save user settings** in the setup menu and press ►.

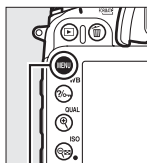

MENU button

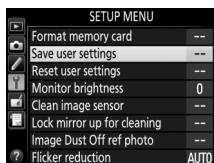

4 Select Save to U1 or Save to U2.

Highlight **Save to U1** or **Save to U2** and press ►.

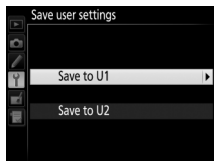

5 Save user settings.

Highlight **Save settings** and press **OK** to assign the settings selected in Steps 1 and 2 to the mode dial position selected in Step 4.

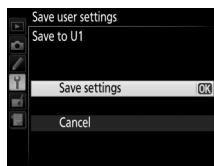

Recalling User Settings

Simply rotate the mode dial to **U1** to recall the settings assigned to **Save to U1**, or to **U2** to recall the settings assigned to **Save to U2**.

Mode dial

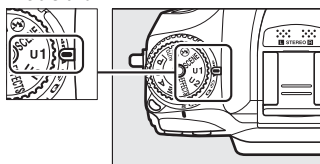

Resetting User Settings

To reset settings for **U1** or **U2** to default values:

1 Select Reset user settings.

Press the **MENU** button to display the menus. Highlight **Reset user settings** in the setup menu and press **▶**.

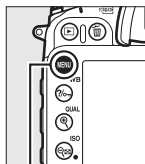

MENU button

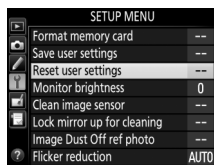

2 Select Reset U1 or Reset U2.

Highlight **Reset U1** or **Reset U2** and press **▶**.

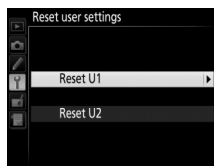

3 Reset user settings.

Highlight **Reset** and press **OK**.

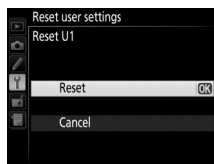

Release Mode

Choosing a Release Mode

To choose a release mode, press the release mode dial lock release and turn the release mode dial to the desired setting.

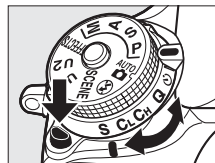

Mode	Description
S	Single frame: Camera takes one photograph each time shutter-release button is pressed.
CL	Continuous low speed: While shutter-release button is held down, camera takes photographs at frame rate selected for Custom Setting d5 (CL mode shooting speed , □ 58, 239). Lower built-in flash (□ 120); continuous release is not available while flash is raised.
CH	Continuous high speed: While shutter-release button is held down, camera records photographs at frame rate given on page 58. Use for moving subjects. Lower built-in flash (□ 120); continuous release is not available while flash is raised.
Q	Quiet shutter-release: As for single frame, except that mirror does not click back into place while shutter-release button is fully pressed, allowing user to control timing of click made by mirror, which is also quieter than in single frame mode. In addition, beep does not sound regardless of setting selected for Custom Setting d1 (Beep ; □ 238).
	Self-timer: Take pictures with the self-timer (□ 59).
MUP	Mirror up: Choose this mode to minimize camera shake in telephoto or close-up photography or in other situations in which the slightest camera movement can result in blurred photographs.

Frame Advance Rate

The frame rate for continuous shooting (low and high speed) varies with the option chosen for image area (□ 63) and, when an NEF (RAW) image quality option is selected, the NEF (RAW) bit depth (□ 67). The table below gives the approximate frame rates for a fully-charged EN-EL15 battery, continuous-servo AF, manual or shutter-priority auto exposure, a shutter speed of $1/250$ s or faster, and the remaining settings at default values.

Image area	Image quality	Approximate frame advance rate	
		CL	CH
DX (24×16)	JPEG/12-bit NEF (RAW)	1–6 fps	6 fps
	14-bit NEF (RAW)	1–5 fps	5 fps
1.3× (18×12)	JPEG/12-bit NEF (RAW)	1–6 fps	7 fps
	14-bit NEF (RAW)		6 fps

Frame rate drops at slow shutter speeds or very small apertures (high f-numbers), when vibration reduction (available with VR lenses) or auto ISO sensitivity control is on (□ 79, 81), or when the battery is low.

The Memory Buffer

The camera is equipped with a memory buffer for temporary storage, allowing shooting to continue while photographs are being saved to the memory card. Up to 100 photographs can be taken in succession; note, however, that the frame rate will drop when the buffer is full (☞ 00). The approximate number of images that can be stored in the buffer at current settings is shown in the exposure-count displays in the viewfinder and control panel while the shutter-release button is pressed. The illustration at right shows the display when space remains in the buffer for about 17 pictures.

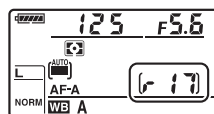

While photographs are being recorded to the memory card, the access lamp next to the memory card slot will light. Depending on shooting conditions and memory card performance, recording may take from a few seconds to a few minutes. *Do not remove the memory card or remove or disconnect the power source until the access lamp has gone out.* If the camera is switched off while data remain in the buffer, the power will not turn off until all images in the buffer have been recorded. If the battery is exhausted while images remain in the buffer, the shutter release will be disabled and the images transferred to the memory card.

See Also

For information on choosing the maximum number of photographs that can be taken in a single burst, see Custom Setting d6 (**Max. continuous release**, □ 240). For information on the number of pictures that can be taken in a single burst, see page 348.

Self-Timer Mode

The self-timer can be used to reduce camera shake or for self-portraits. Before shooting, mount the camera on a tripod or place the camera on a stable, level surface.

1 Select self-timer mode.

Press the release mode dial lock release and turn the release mode dial to .

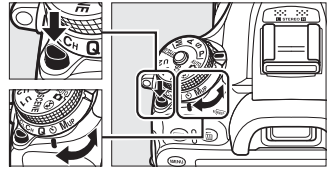

Release mode dial

2 Frame the photograph and focus.

In single-servo autofocus ( 71), photographs can only be taken if the in-focus (●) indicator appears in the viewfinder.





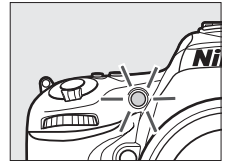

3 Start the timer.

Press the shutter-release button all the way down to start the timer. The self-timer lamp will start to flash. Two seconds before the photograph is taken, the self-timer lamp will stop flashing. The shutter will be released about ten seconds after the timer starts.



To turn the self-timer off before a photograph is taken, turn the release mode dial to another setting.

Using the Built-in Flash

Before taking a photograph with the flash in **P**, **S**, **A**, **M**, or **!** modes, press the  button to raise the flash and wait for the  indicator to be displayed in the viewfinder ( 119). Shooting will be interrupted if the flash is raised after the self-timer has started. Note that only one photograph will be taken when the flash fires, regardless of the number of exposures selected for Custom Setting c3 (**Self-timer**;  237).

Cover the Viewfinder

When taking photos without your eye to the viewfinder, remove the DK-23 rubber eyecup (①) and insert the supplied DK-5 eyepiece cap as shown (②). This prevents light entering via the viewfinder interfering with exposure. Hold the camera firmly when removing the rubber eyecup.

DK-23 rubber eyecup

DK-5 eyepiece cap

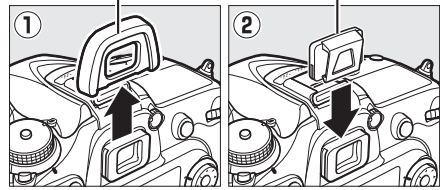

See Also

For information on choosing the duration of the self-timer, the number of shots taken, and the interval between shots, see Custom Setting c3 (**Self-timer**; □ 237). For information on setting a beep to sound during the timer count-down, see Custom Setting d1 (**Beep**; □ 238).



Mirror up Mode

Choose this mode to minimize blurring caused by camera movement when the mirror is raised. Use of a tripod is recommended.

1 Select mirror up mode.

Press the release mode dial lock release and rotate the release mode dial to **MUP**.

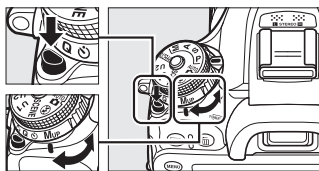

Release mode dial

2 Raise the mirror.

Frame the picture, focus, and then press the shutter-release button the rest of the way down to raise the mirror.



Mirror Up

While the mirror is raised, photos can not be framed in the viewfinder and autofocus and metering will not be performed.

3 Take a picture.

Press the shutter-release button all the way down again to take a picture. To prevent blurring caused by camera movement, press the shutter-release button smoothly, or use an optional remote cord or wireless remote controller (□ 309, 310). The mirror lowers when shooting ends.



Mirror up Mode

A picture will be taken automatically if no operations are performed for about 30 s after the mirror is raised.

See Also

For information on using the optional ML-L3 remote control for mirror-up photography, see page 127.







Image Recording Options

Image Area

Choose an image area from **DX (24×16)** and **1.3× (18×12)**.

Option	Description
 DX (24×16)	Pictures are recorded using a 23.5 × 15.6 mm image area (DX format).
 1.3× (18×12)	Pictures are recorded using a 18.8 × 12.5 mm image area, producing a telephoto effect without the need to change lenses (□ 68, 167). The camera can also record more images per second during continuous shooting (□ 58).

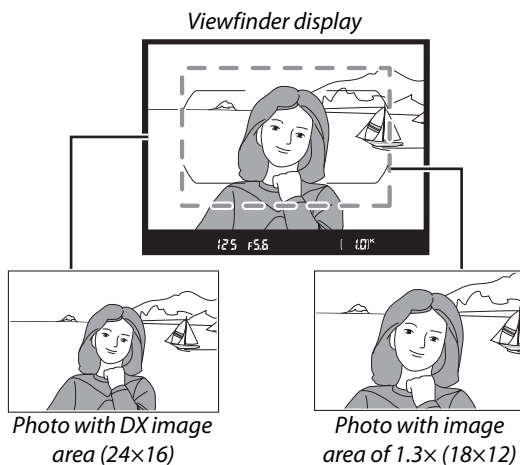
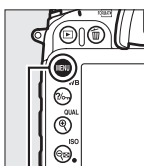

Image area can be set using the **Image area** option in the shooting menu or by pressing a control and rotating a command dial (☞ 65).

■ ■ The Image Area Menu

1 Select Image area in the shooting menu.

Press MENU to display the menus. Highlight **Image area** in the shooting menu (☞ 224) and press ►.



MENU button

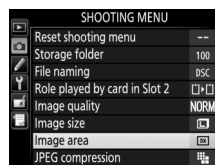

2 Adjust settings.

Choose an option and press OK.

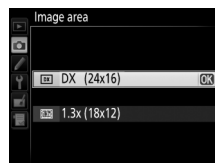

✍ The Viewfinder Display

The viewfinder display for the 1.3× DX crop is shown at right. A  icon is displayed in the viewfinder when the 1.3× DX crop is selected.



1.3× DX crop

✍ Image Area

The selected option is shown in the information display.

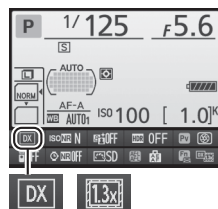

1 Assign image area selection to a camera control.

Select **Choose image area** as the “press + command dials” option for a camera control in the Custom Settings menu (☞ 229). Image area selection can be assigned to the **Fn** button (Custom Setting f2, **Assign Fn button**, ☞ 253), the depth-of-field preview button (Custom Setting f3, **Assign preview button**, ☞ 255), or the **AE-L/AF-L** button (Custom Setting f4, **Assign AE-L/AF-L button**, ☞ 256).

2 Use the selected control to choose an image area.

The image area can be selected by pressing the selected button and rotating the main or sub-command dial until the desired crop is displayed in the viewfinder (☞ 64).

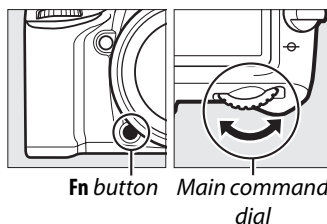

The option currently selected for image area can be viewed by pressing the button to display the image area in the control panel, viewfinder, or information display. DX format is displayed as “24 – 16” and the 1.3× DX crop as “18 – 12”.

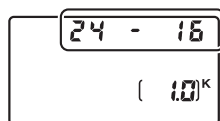

Image Size

Image size varies with the option selected for image area (☞ 68).

See Also

See page 167 for information on the crops available in movie live view.

Image Quality and Size

Together, image quality and size determine how much space each photograph occupies on the memory card. Larger, higher quality images can be printed at larger sizes but also require more memory, meaning that fewer such images can be stored on the memory card (□ 348).

Image Quality

Choose a file format and compression ratio (image quality).

Option	File type	Description
NEF (RAW)	NEF	Raw data from the image sensor are saved directly to the memory card. Settings such as white balance and contrast can be adjusted after shooting.
JPEG fine	JPEG	Record JPEG images at a compression ratio of roughly 1 : 4 (fine quality).*
JPEG normal		Record JPEG images at a compression ratio of roughly 1 : 8 (normal quality).*
JPEG basic		Record JPEG images at a compression ratio of roughly 1 : 16 (basic quality).*
NEF (RAW) + JPEG fine	NEF/ JPEG	Two images are recorded, one NEF (RAW) image and one fine-quality JPEG image.
NEF (RAW) + JPEG normal		Two images are recorded, one NEF (RAW) image and one normal-quality JPEG image.
NEF (RAW) + JPEG basic		Two images are recorded, one NEF (RAW) image and one basic-quality JPEG image.

* **Size priority** selected for **JPEG compression**.

Image quality can be set by pressing the  (**QUAL**) button and rotating the main command dial until the desired setting is displayed in the control panel.

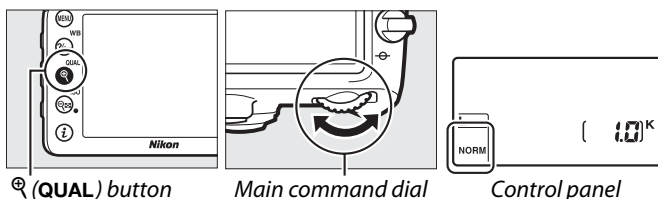

The Shooting Menu

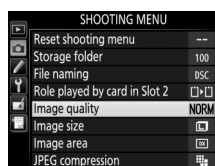

Image quality can also be adjusted using the **Image quality** option in the shooting menu (□ 224).



The following options can be accessed from the shooting menu. Press the **MENU** button to display the menus, highlight the desired option and press **▶**.



■ ■ **JPEG Compression**

Choose the type of compression for JPEG images.

Option	Description
 Size priority	Images are compressed to produce relatively uniform file size.
 Optimal quality	Optimal image quality. File size varies with scene recorded.



■ ■ **NEF (RAW) Recording > Type**

Choose the type of compression for NEF (RAW) images.



Option	Description
 Lossless compressed	NEF images are compressed using a reversible algorithm, reducing file size by about 20–40% with no effect on image quality.
 Compressed	NEF images are compressed using a non-reversible algorithm, reducing file size by about 35–55% with almost no effect on image quality.

■ ■ **NEF (RAW) Recording > NEF (RAW) Bit Depth**

Choose a bit depth for NEF (RAW) images.

Option	Description
 12-bit	NEF (RAW) images are recorded at a bit-depth of 12 bits.
 14-bit	NEF (RAW) images are recorded at a bit depth of 14 bits, producing files larger than those with a bit depth of 12 bits but increasing the color data recorded.

NEF (RAW) Images

NEF (RAW) images can be viewed on the camera or using software such as Capture NX 2 (available separately;  309) or ViewNX 2 (available on the supplied ViewNX 2 CD). Note that the option selected for image size does not affect the size of NEF (RAW) images; when viewed on a computer, NEF (RAW) images have the dimensions given for large (-size) images in the table on page 68. JPEG copies of NEF (RAW) images can be created using the **NEF (RAW) processing** option in the retouch menu ( 282).

NEF+JPEG

When photographs taken at settings of NEF (RAW) + JPEG are viewed on the camera with only one memory card inserted, only the JPEG image will be displayed. If both copies are recorded to the same memory card, both copies will be erased when the photo is deleted. If the JPEG copy is recorded to a separate memory card using the **Role played by card in Slot 2 > RAW Slot 1—JPEG Slot 2** option, deleting the JPEG copy will not delete the NEF (RAW) image.



Image Size

Image size is measured in pixels. Choose from **L** Large, **M** Medium, or **S** Small (note that image size varies depending on the option selected for **Image area**, **63**):

Image area	Option	Size (pixels)	Print size (cm/in.)*
DX (24×16)	Large	6000 × 4000	50.8 × 33.9/20.0 × 13.3
	Medium	4496 × 3000	38.1 × 25.4/15.0 × 10.0
	Small	2992 × 2000	25.3 × 16.9/10.0 × 6.7
1.3× (18×12)	Large	4800 × 3200	40.6 × 27.1/16.0 × 10.7
	Medium	3600 × 2400	30.5 × 20.3/12.0 × 8.0
	Small	2400 × 1600	20.3 × 13.5/ 8.0 × 5.3

* Approximate size when printed at 300 dpi. Print size in inches equals image size in pixels divided by printer resolution in dots per inch (dpi; 1 inch = approximately 2.54 cm).

Image size can be set by pressing the **QUAL** button and rotating the sub-command dial until the desired setting is displayed in the control panel.

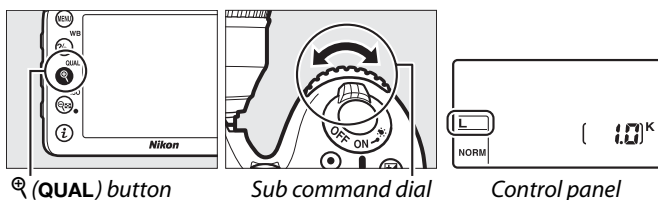

The Shooting Menu

Image size can also be adjusted using the **Image size** option in the shooting menu (**224**).

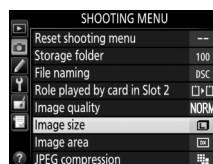

Using Two Memory Cards

When two memory cards are inserted in the camera, you can use the **Role played by card in Slot 2** item in the shooting menu to choose the role played by the card in Slot 2. Choose from **Overflow** (the card in Slot 2 is used only when the card in Slot 1 is full), **Backup** (each picture is recorded twice, once to the card in Slot 1 and again to the card in Slot 2), and **RAW Slot 1—JPEG Slot 2** (as for **Backup**, except that the NEF/RAW copies of photos recorded at settings of NEF/RAW + JPEG are recorded only to the card in Slot 1 and the JPEG copies only to the card in Slot 2).



“Backup” and “RAW Slot 1—JPEG Slot 2”

The camera shows the number of exposures remaining on the card with the least amount of memory. Shutter release will be disabled when either card is full.

Recording Movies

When two memory cards are inserted in the camera, the slot used to record movies can be selected using the **Movie settings > Destination** option in the shooting menu (☰ 169).



Focus

This section describes the focus options available when photographs are framed in the viewfinder. Focus can be adjusted automatically (see below) or manually (□ 78). The user can also select the focus point for automatic or manual focus (□ 75) or use focus lock to focus to recompose photographs after focusing (□ 76).

Autofocus

To use autofocus, rotate the focus-mode selector to **AF**. *Focus-mode selector*

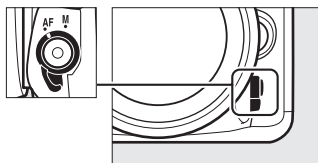

Autofocus Mode

Choose from the following autofocus modes:

Mode	Description
AF-A	Auto-servo AF: Camera automatically selects single-servo autofocus if subject is stationary, continuous-servo autofocus if subject is moving.
AF-S	Single-servo AF: For stationary subjects. Focus locks when shutter-release button is pressed halfway. At default settings, shutter can only be released when in-focus indicator (●) is displayed (<i>focus priority</i> ; □ 231).
AF-C	Continuous-servo AF: For moving subjects. Camera focuses continuously while shutter-release button is pressed halfway; if subject moves, camera will engage <i>predictive focus tracking</i> to predict final distance to subject and adjust focus as necessary. At default settings, shutter can be released whether or not subject is in focus (<i>release priority</i> ; □ 231).

Predictive Focus Tracking

In **AF-C** mode or when continuous-servo autofocus is selected in **AF-A** mode, the camera will initiate predictive focus tracking if the subject moves toward or away from the camera while the shutter-release button is pressed halfway. This allows the camera to track focus while attempting to predict where the subject will be when the shutter is released.

Autofocus mode can be selected by pressing the AF-mode button and rotating the main command dial until the desired setting is displayed in the viewfinder or control panel.

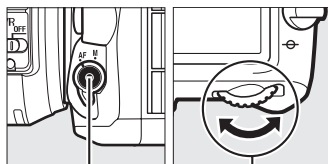

AF-mode button Main command dial

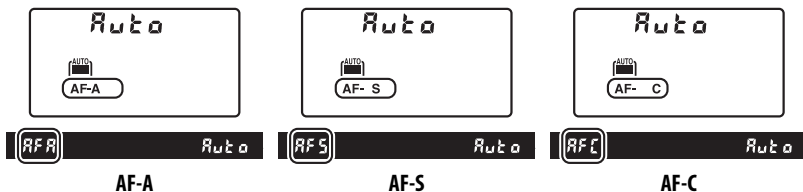

Getting Good Results with Autofocus

Autofocus does not perform well under the conditions listed below. The shutter release may be disabled if the camera is unable to focus under these conditions, or the in-focus indicator (●) may be displayed and the camera may sound a beep, allowing the shutter to be released even when the subject is not in focus. In these cases, focus manually (78) or use focus lock (76) to focus on another subject at the same distance and then recompose the photograph.

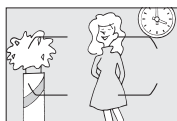

There is little or no contrast between the subject and the background.

Example: Subject is the same color as the background.

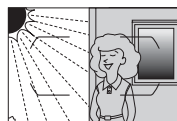

The focus point contains areas of sharply contrasting brightness.

Example: Subject is half in the shade.



The focus point contains objects at different distances from the camera.

Example: Subject is inside a cage.

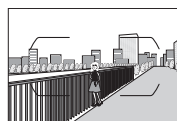

Background objects appear larger than the subject.

Example: A building is in the frame behind the subject.



The subject is dominated by regular geometric patterns.

Example: Blinds or a row of windows in a skyscraper.

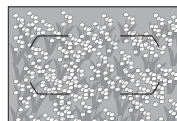

The subject contains many fine details.

Example: A field of flowers or other subjects that are small or lack variation in brightness.

See Also

For information on using focus priority in continuous-servo AF, see Custom Setting a1 (**AF-C priority selection**, 231). For information on using release priority in single-servo AF, see Custom Setting a2 (**AF-S priority selection**, 231). See page 155 for information on the autofocus options available in live view or during movie recording.

AF-Area Mode

Choose how the focus point for autofocus is selected.

- **Single-point AF:** Select the focus point as described on page 75; the camera will focus on the subject in the selected focus point only. Use with stationary subjects.
- **Dynamic-area AF:** Select the focus point as described on page 75. In **AF-A** and **AF-C** focus modes, the camera will focus based on information from surrounding focus points if the subject briefly leaves the selected point. The number of focus points varies with the mode selected:
 - **9-point dynamic-area AF:** Choose when there is time to compose the photograph or when photographing subjects that are moving predictably (e.g., runners or race cars on a track).
 - **21-point dynamic-area AF:** Choose when photographing subjects that are moving unpredictably (e.g., players at a football game).
 - **51-point dynamic-area AF:** Choose when photographing subjects that are moving quickly and can not be easily framed in the viewfinder (e.g., birds).
- **3D-tracking:** Select the focus point as described on page 75. In **AF-A** and **AF-C** focus modes, the camera will track subjects that leave the selected focus point and select new focus points as required. Use to quickly compose pictures with subjects that are moving erratically from side to side (e.g., tennis players). If the subject leaves viewfinder, remove your finger from the shutter-release button and recompose the photograph with the subject in the selected focus point.

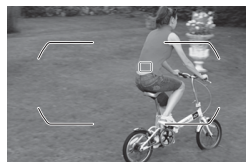
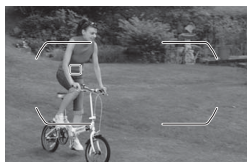

- **Auto-area AF:** The camera automatically detects the subject and selects the focus point. If a type G or D lens is used (📖 296), the camera can distinguish human subjects from the background for improved subject detection. The active focus points are highlighted briefly after the camera focuses; in **AF-C** mode or when continuous-servo autofocus is selected in **AF-A** mode, the main focus point remains highlighted after the other focus points have turned off.

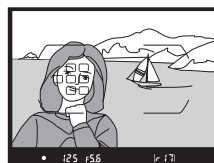

AF-area mode can be selected by pressing the AF-mode button and rotating the sub-command dial until the desired setting is displayed in the viewfinder or control panel.

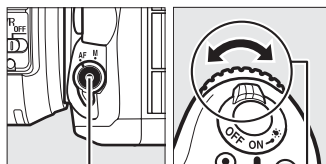

AF-mode button

Sub-command dial

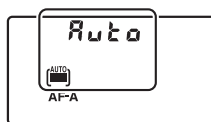

Control panel

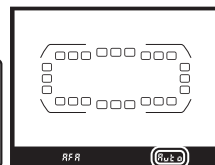

Viewfinder

3D-tracking

When the shutter-release button is pressed halfway, the colors in the area surrounding the focus point are stored in the camera. Consequently 3D-tracking may not produce the desired results with subjects that are the same color as the background or that occupy a very small area of the frame.

AF-Area Mode

AF-area mode is shown in the control panel and viewfinder.

AF-area mode	Control panel	Viewfinder	AF-area mode	Control panel	Viewfinder
Single-point AF	S	S	51-point dynamic-area AF*	d51	d51
9-point dynamic-area AF*	d9	d9	3D-tracking	3d	3d
21-point dynamic-area AF*	d21	d21	Auto-area AF	Auto	Auto

* Only active focus point is displayed in the viewfinder. Remaining focus points provide information to assist focus operation.

Manual Focus

Single-point AF is automatically selected when manual focus is used.

See Also

For information on adjusting how long the camera waits before refocusing when an object moves in front of the camera, see Custom Setting a3 (**Focus tracking with lock-on**, □ 232). See page 156 for information on the autofocus options available in live view or during movie recording.

Focus Point Selection

The camera offers a choice of 51 focus points that can be used to compose photographs with the main subject positioned almost anywhere in the frame.

1 Rotate the focus selector lock to ●.

This allows the multi selector to be used to select the focus point.

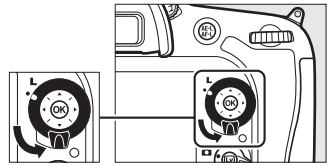

Focus selector lock

2 Select the focus point.

Use the multi selector to select the focus point in the viewfinder while the exposure meters are on. Press **OK** to select the center focus point.

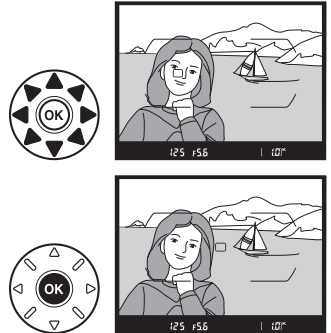

The focus selector lock can be rotated to the locked (L) position following selection to prevent the selected focus point from changing when the multi selector is pressed.

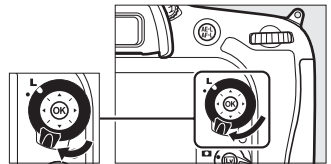

Auto-area AF

The focus point for auto-area AF is selected automatically; manual focus-point selection is not available.

See Also

For information on choosing when the focus point is illuminated, see Custom Setting a4 (**AF point illumination**, □ 232). For information on setting focus-point selection to “wrap around,” see Custom Setting a5 (**Focus point wrap-around**, □ 232). For information on choosing the number of focus points that can be selected using the multi selector, see Custom Setting a6 (**Number of focus points**, □ 233). For information on changing the role of the **OK** button, see Custom Setting f1 (**OK button**, □ 252).

Focus Lock

Focus lock can be used to change the composition after focusing, making it possible to focus on a subject that will not be in a focus point in the final composition. If the camera is unable to focus using autofocus (□ 72), focus lock can also be used to recompose the photograph after focusing on another object at the same distance as your original subject. Focus lock is most effective when an option other than auto-area AF is selected for AF-area mode (□ 73).

1 Focus.

Position the subject in the selected focus point and press the shutter-release button halfway to initiate focus. Check that the in-focus indicator (●) appears in the viewfinder.



2 Lock focus.

AF-A and AF-C focus modes: With the shutter-release button pressed halfway (①), press the AE-L/AF-L button (②) to lock both focus and exposure (an AE-L icon will be displayed in the viewfinder). Focus and exposure will remain locked while the AE-L/AF-L button is pressed, even if you later remove your finger from the shutter-release button.

AF-S focus mode: Focus locks automatically when the in-focus indicator (●) appears, and remain locked until you remove your finger from the shutter-release button. Focus can also be locked by pressing the AE-L/AF-L button (see above).

Shutter-release button

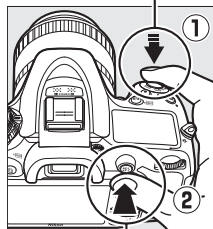

AE-L/AF-L button





3 Recompose the photograph and shoot.

Focus will remain locked between shots if you keep the shutter-release button pressed halfway (AF-S) or keep the AE-L/AF-L button pressed, allowing several photographs in succession to be taken at the same focus setting.





Do not change the distance between the camera and the subject while focus lock is in effect. If the subject moves, focus again at the new distance.

Locking Focus with the AF-ON Button

If desired, the autofocus can be assigned to a separate button in the Custom Settings menu, in which case focus will lock when the button is pressed and remain locked until the button is pressed again. The shutter can be released at any time regardless of the options selected for Custom Settings a1 (**AF-C priority selection**,  231) and a2 (**AF-S priority selection**,  231), and the in-focus indicator () will not be displayed in the viewfinder.

See Also

See Custom setting c1 (**Shutter-release button AE-L**,  236) for information on using the shutter-release button to lock exposure, Custom Setting f4 (**Assign AE-L/AF-L button**,  256) for information on choosing the role played by the  AE-L/AF-L button.



Manual Focus

Manual focus is available for lenses that do not support autofocus (non-AF NIKKOR lenses) or when the autofocus does not produce the desired results (🗨 72).

- **AF-S lenses:** Set the lens focus mode switch to **M**.
- **Other AF lenses:** Set the lens focus mode switch (if present) and camera focus-mode selector to **M**.

☑ **AF Lenses That Are Not AF-S Lenses**

Except when using an AF-S lens, do not use AF lenses with the lens focus mode switch set to **M** and the camera focus-mode selector set to **AF**. Failure to observe this precaution could damage the camera or lens.

Focus-mode selector

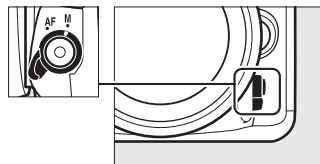

- **Manual focus lenses:** Set the camera focus-mode selector to **M**.

To focus manually, adjust the lens focus ring until the image displayed on the clear matte field in the viewfinder is in focus. Photographs can be taken at any time, even when the image is not in focus.

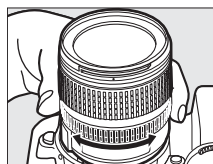

■ ■ **The Electronic Rangefinder**

The viewfinder focus indicator can be used to confirm whether the subject in the selected focus point is in focus (the focus point can be selected from any of the 51 focus points). After positioning the subject in the selected focus point, press the shutter-release button halfway and rotate the lens focus ring until the in-focus indicator (●) is displayed. Note that with the subjects listed on page 72, the in-focus indicator may sometimes be displayed when the subject is not in focus; confirm focus in the viewfinder before shooting.



✍ **Focal Plane Position**

To determine the distance between your subject and the camera, measure from the focal plane mark (⊖) on the camera body. The distance between the lens mounting flange and the focal plane is 46.5 mm (1.83 in.).

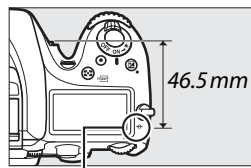

Focal plane mark

ISO Sensitivity

The higher the ISO sensitivity, the less light needed to make an exposure, allowing higher shutter speeds or smaller apertures. Choosing **Auto** allows the camera to set ISO sensitivity automatically in response to lighting conditions. The following options are available:

Mode	ISO sensitivity
	Auto
P, S, A, M	100–6400 in steps of $\frac{1}{3}$ EV; Hi 0.3 to Hi 2
Other shooting modes	Auto; 100–6400 in steps of $\frac{1}{3}$ EV; Hi 0.3 to Hi 2

ISO sensitivity can be adjusted by pressing the  (ISO) button and rotating the main command dial until the desired setting is displayed in the control panel or viewfinder.

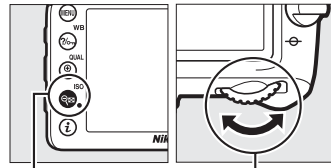

 (ISO) button Main command dial

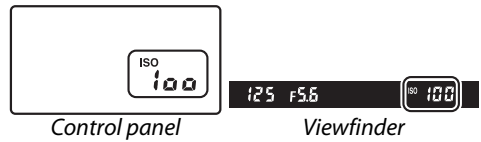

Viewing ISO Sensitivity in the Information Display

ISO sensitivity is shown in the information display. When **Auto** is selected, **ISO AUTO** and the sensitivity chosen by the camera is displayed as shown at right.

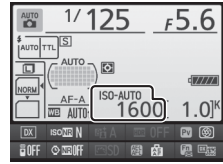

Auto

If the mode dial is rotated to **P**, **S**, **A**, or **M** after **Auto** is selected for ISO sensitivity in another mode, the ISO sensitivity last selected in **P**, **S**, **A**, or **M** mode will be restored.

Hi 0.3–Hi 2

The settings **Hi 0.3** through **Hi 2** correspond to ISO sensitivities 0.3–2 EV over ISO 6400 (ISO 8000–25600 equivalent). Pictures taken at these settings are more likely to be subject to noise (randomly-spaced bright pixels, fog, or lines).

The Shooting Menu

ISO sensitivity can also be adjusted using the **ISO sensitivity settings** option in the shooting menu (□ 224).

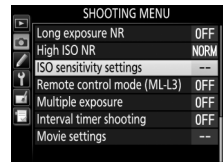

See Also

For information on choosing the ISO sensitivity step size, see Custom Setting b1 (**ISO sensitivity step value**; □ 234). For information on displaying ISO sensitivity in the control panel or adjusting ISO sensitivity without using the  (**ISO**) button, see Custom Setting d3 (**ISO display and adjustment**; □ 239). For information on using the **High ISO NR** option in the shooting menu to reduce noise at high ISO sensitivities, see page 228.

Auto ISO Sensitivity Control *(P, S, A, and M Modes Only)*

If **On** is selected for **ISO sensitivity settings** > **Auto ISO sensitivity control** in the shooting menu, ISO sensitivity will automatically be adjusted if optimal exposure can not be achieved at the value selected by the user (ISO sensitivity is adjusted appropriately when the flash is used).

1 Select Auto ISO sensitivity control for ISO sensitivity settings in the shooting menu.

To display the menus, press the **MENU** button. Select **ISO sensitivity settings** in the shooting menu, highlight **Auto ISO sensitivity control** and press **▶**.

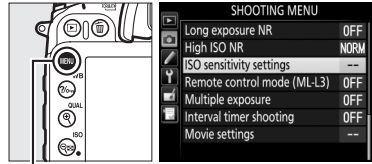

MENU button

2 Select On.

Highlight **On** and press **OK** (if **Off** is selected, ISO sensitivity will remain fixed at the value selected by the user).

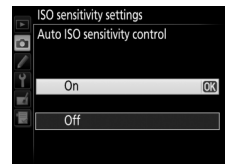

3 Adjust settings.

The maximum value for auto ISO sensitivity can be selected using **Maximum sensitivity** (the minimum value for auto ISO sensitivity is automatically set to ISO 100; note that if the ISO sensitivity selected by the user is higher than that chosen for **Maximum sensitivity**, the value selected by the user will be used instead). In modes **P** and **A**, sensitivity will only be adjusted if underexposure would result at the shutter speed selected for **Minimum shutter speed** ($1/4000$ – 1 s, or **Auto**; in modes **S** and **M**, ISO sensitivity will be adjusted for optimal exposure at the shutter speed selected by the user). If **Auto** (available only with CPU lenses; equivalent to $1/30$ s when a non-CPU lens is used) is selected, the camera will choose the minimum shutter speed based on the focal length of the lens (auto shutter-speed selection can be fine-tuned by highlighting **Auto** and pressing **▶**; for example, even faster values than those usually selected automatically by the camera can be used with telephoto lenses to reduce blur). Shutter speeds slower than the minimum value may be used if optimum exposure can not be achieved at the ISO sensitivity value selected for **Maximum sensitivity**. Press **OK** to exit when settings are complete.

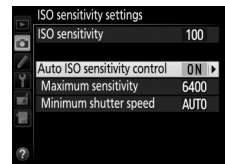

ISO

When **On** is selected, the viewfinder and control panel show **ISO-AUTO**. When sensitivity is altered from the value selected by the user, these indicators flash.

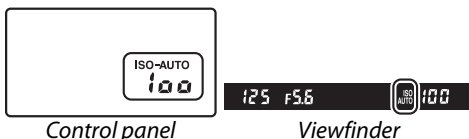

Turning Auto ISO Sensitivity Control On or Off

You can turn auto ISO sensitivity control on or off by pressing the **ISO** button and rotating the sub-command dial. **ISO-AUTO** is displayed when auto ISO sensitivity control is on.

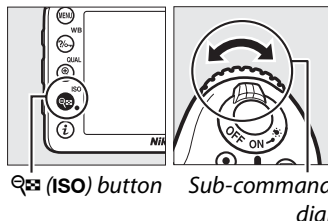

Auto ISO Sensitivity Control

Noise (randomly-spaced bright pixels, fog, or lines) is more likely at higher sensitivities. Use the **High ISO NR** option in the shooting menu to reduce noise (see page 228). If the shutter speed selected for **Minimum shutter speed** is slower than sync speed selected for Custom Setting e1 (**Flash sync speed**, □ 244), the sync speed will be used as the minimum shutter speed for auto ISO sensitivity control during flash photography. Note that ISO sensitivity may be raised automatically when auto ISO sensitivity control is used in combination with slow sync flash modes (available with the built-in flash and the optional flash units listed on page 304), possibly preventing the camera from selecting slow shutter speeds.

When auto ISO sensitivity control is in effect, the adjusted and selected values appear in the information display as shown at right.

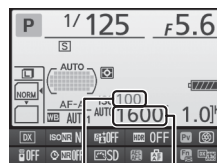

Selected value

Adjusted value





Exposure

Metering

(P, S, A, and M Modes Only)

Choose how the camera sets exposure in **P**, **S**, **A**, and **M** modes (in other modes, the camera selects the metering method automatically).

Option	Description
	Matrix: Produces natural results in most situations. Camera meters a wide area of the frame and set exposure according to tone distribution, color, composition, and, with type G or D lenses (□ 296), distance information (3D color matrix metering II; with other CPU lenses, camera uses color matrix metering II, which does not include 3D distance information). With non-CPU lenses, camera uses color matrix metering if focal length and maximum aperture are specified using Non-CPU lens data option in setup menu (□ 150); otherwise camera uses center-weighted metering.
	Center-weighted: Camera meters entire frame but assigns greatest weight to center area (if CPU lens is attached, size of area can be selected using Custom Setting b4, Center-weighted area , □ 236; if non-CPU lens is attached, area is 8 mm in diameter). Classic meter for portraits; recommended when using filters with an exposure factor (filter factor) over 1x.*
	Spot: Camera meters circle 3.5 mm (0.14 in.) in diameter (approximately 2.5% of frame). Circle is centered on current focus point, making it possible to meter off-center subjects (if non-CPU lens is used or if auto-area AF is in effect, camera will meter center focus point). Ensures that subject will be correctly exposed, even when background is much brighter or darker.*

* For improved precision with non-CPU lenses, specify lens focal length and maximum aperture in **Non-CPU lens data** menu (□ 150).

To choose a metering option, press the  (**FORMAT**) button and rotate the main command dial until the desired setting is displayed in the control panel.

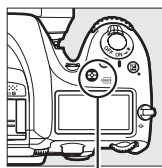

 button



Main command dial



Control panel

See Also

For information on making separate adjustments to optimal exposure for each metering method, see Custom Setting b5 (**Fine-tune optimal exposure**, □ 236).

Autoexposure Lock

Use autoexposure lock to recompose photographs after using center-weighted metering and spot metering to meter exposure. Note that matrix metering will not produce the desired results.

1 Lock exposure.

Position the subject in the selected focus point and press the shutter-release button halfway. With the shutter-release button pressed halfway and the subject positioned in the focus point, press the $\overset{\text{AE-L}}{\text{AF-L}}$ **AE-L/AF-L** button to lock exposure (if you are using autofocus, focus will also lock; confirm that the in-focus indicator (●) appears in the viewfinder).

Shutter-release button

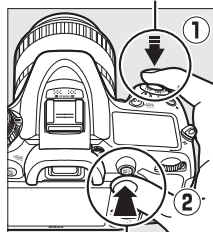

$\overset{\text{AE-L}}{\text{AF-L}}$ **AE-L/AF-L** button

While exposure lock is in effect, an AE-L indicator will appear in the viewfinder.



2 Recompose the photograph.

Keeping the $\overset{\text{AE-L}}{\text{AF-L}}$ **AE-L/AF-L** button pressed, recompose the photograph and shoot.

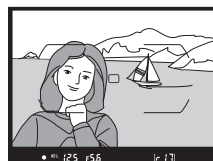

Metered Area

In spot metering, exposure will be locked at the value metered in a 3.5-mm (0.14 in.) circle centered on the selected focus point. In center-weighted metering, exposure will be locked at the value metered in a 8-mm circle in the center of the viewfinder.



Adjusting Shutter Speed and Aperture

While exposure lock is in effect, the following settings can be adjusted without altering the metered value for exposure:

Mode	Setting
P	Shutter speed and aperture (flexible program;  48)
S	Shutter speed
A	Aperture

The new values can be confirmed in the viewfinder and control panel. Note that metering can not be changed while exposure lock is in effect.

See Also

If **On** is selected for Custom Setting c1 (**Shutter-release button AE-L**,  236), exposure will lock when the shutter-release button is pressed halfway. For information on changing the role of the  **AE-L/AF-L** button, see Custom Setting f4 (**Assign AE-L/AF-L button**,  256).



Exposure Compensation

(P, S, A, M and  Modes Only)

Exposure compensation is used to alter exposure from the value suggested by the camera, making pictures brighter or darker. It is most effective when used with center-weighted or spot metering ( 83). Choose from values between -5 EV (underexposure) and $+5$ EV (overexposure) in increments of $1/3$ EV. In general, positive values make the subject brighter while negative values make it darker.



-1 EV



No exposure compensation



$+1$ EV

To choose a value for exposure compensation, press the  button and rotate the main command dial until the desired value is displayed in the control panel or viewfinder.

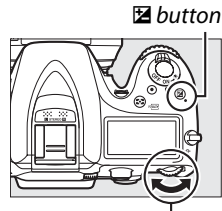

Main command dial

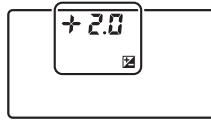
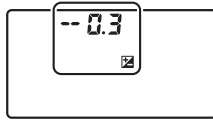
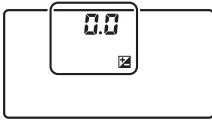

± 0 EV



( button pressed)





-0.3 EV

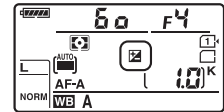

$+2.0$ EV

At values other than ± 0.0 , the 0 at the center of the exposure indicators will flash (modes P, S, and A only) and a  icon will be displayed in the control panel and viewfinder after you release the  button. The current value for exposure compensation can be confirmed in the exposure indicator by pressing the  button.



Normal exposure can be restored by setting exposure compensation to ± 0 . Exposure compensation is not reset when the camera is turned off, but is reset if you select another mode after choosing .



Mode M

In mode **M**, exposure compensation affects only the exposure indicator; shutter speed and aperture do not change.

Using a Flash

When a flash is used, exposure compensation affects both flash level and exposure, altering the brightness of both the main subject and the background. Custom Setting e4 (**Exposure comp. for flash**,  250) can be used to restrict the effects of exposure compensation to the background only.

See Also

For information on choosing the size of the increments available for exposure compensation, see Custom Setting b2 (**EV steps for exposure cntrl**,  234). For information on making adjustments to exposure compensation without pressing the  button, see Custom Setting b3 (**Easy exposure compensation**,  235). For information on automatically varying exposure, flash level, white balance, or Active D-Lighting, see page 133.













White Balance

(P, S, A, and M Modes Only)

White balance ensures that colors are unaffected by the color of the light source. In modes other than **P**, **S**, **A**, and **M**, white balance is set automatically by the camera. Auto white balance is recommended for most light sources in **P**, **S**, **A**, and **M** modes, but other values can be selected if necessary according to the type of source:

Option	Colortemp.*	Description
AUTO Auto	3500–8000 K	White balance is adjusted automatically. For best results, use type G or D lens. If built-in or optional flash fires, results are adjusted for flash.
Normal		
Keep warm lighting colors		
 Incandescent	3000 K	Use under incandescent lighting.
 Fluorescent		Use with:
Sodium-vapor lamps	2700 K	• Sodium-vapor lighting (found in sports venues).
Warm-white fluorescent	3000 K	• Warm-white fluorescent lights.
White fluorescent	3700 K	• White fluorescent lights.
Cool-white fluorescent	4200 K	• Cool-white fluorescent lights.
Day white fluorescent	5000 K	• Daylight white fluorescent lights.
Daylight fluorescent	6500 K	• Daylight fluorescent lights.
High temp. mercury-vapor	7200 K	• High color temperature light sources (e.g. mercury-vapor lamps).
 Direct sunlight	5200 K	Use with subjects lit by direct sunlight.
 Flash	5400 K	Use with built-in or optional flash.
 Cloudy	6000 K	Use in daylight under overcast skies.
 Shade	8000 K	Use in daylight with subjects in the shade.
 Choose color temp.	2500–10000 K	Choose color temperature from list of values (□ 94).
PRE Preset manual	—	Use subject, light source, or existing photograph as reference for white balance (□ 95).

* All values are approximate and do not reflect fine-tuning (if applicable).

White balance is set by pressing the  (**WB**) button and rotating the main command dial until the desired setting is displayed in the control panel.

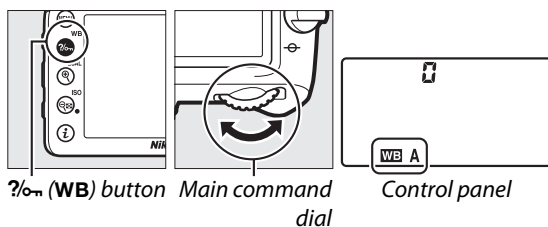

The Shooting Menu

White balance can also be adjusted using the **White balance** option in the shooting menu (☐ 224), which also can be used to fine-tune white balance (☐ 91) or measure a value for preset white balance (☐ 95). The **Auto** option in the **White balance** menu offers a choice of **Normal** and **Keep warm lighting colors**, which preserves the warm colors produced by incandescent lighting, while the  **Fluorescent** option can be used to select the light source from the bulb types.













Studio Flash Lighting

Auto white balance may not produce the desired results with large studio flash units. Use preset white balance or set white balance to **Flash** and use fine tuning to adjust white balance.

Color Temperature

The perceived color of a light source varies with the viewer and other conditions. Color temperature is an objective measure of the color of a light source, defined with reference to the temperature to which an object would have to be heated to radiate light in the same wavelengths. While light sources with a color temperature in the neighborhood of 5000–5500 K appear white, light sources with a lower color temperature, such as incandescent light bulbs, appear slightly yellow or red. Light sources with a higher color temperature appear tinged with blue. The camera white balance options are adapted to the following color temperatures (all figures are approximate):

-  (sodium-vapor lamps): **2700 K**
-  (incandescent)/
•  (warm-white fluorescent): **3000 K**
-  (white fluorescent): **3700 K**
-  (cool-white fluorescent): **4200 K**
-  (day white fluorescent): **5000 K**
-  (direct sunlight): **5200 K**
-  (flash): **5400 K**
-  (cloudy): **6000 K**
-  (daylight fluorescent): **6500 K**
-  (high temp. mercury-vapor): **7200 K**
-  (shade): **8000 K**

See Also

When **WB bracketing** is selected for Custom Setting e6 (**Auto bracketing set**, ☐ 251), the camera will create several images each time the shutter is released. White balance will be varied with each image, “bracketing” the value currently selected for white balance (☐ 137).

Fine-Tuning White Balance

White balance can be “fine-tuned” to compensate for variations in the color of the light source or to introduce a deliberate color cast into an image. White balance is fine-tuned using the **White balance** option in the shooting menu or by pressing the **WB** button and rotating the sub-command dial.

■ The White Balance Menu

1 Select a white balance option in the shooting menu.

To display the menu, press the **MENU** button. Select **White balance** in the shooting menu, then highlight a white balance option and press **▶**. If an option other than **Auto**, **Fluorescent**, **Choose color temp.**, or **Preset manual** is selected, proceed to Step 2. If **Auto**, **Fluorescent**, or **Choose color temp.** is selected, highlight the desired setting and press **▶**. For information on fine-tuning preset white balance, see page 101.

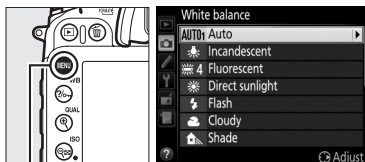

MENU button

2 Fine tune white balance.

Use the multi selector to fine-tune white balance. White balance can be fine-tuned on the amber (A)–blue (B) axis and the green (G)–magenta (M) axis. The horizontal (amber–blue) axis corresponds to color temperature, with each increment equivalent to about 5 mired (□ 93). The vertical (green–magenta) axis has the similar effects to the corresponding color compensation (CC) filters.

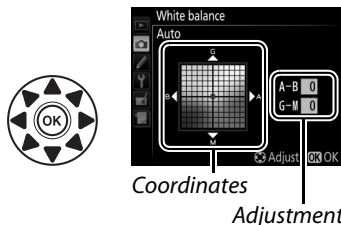

Coordinates

Adjustment

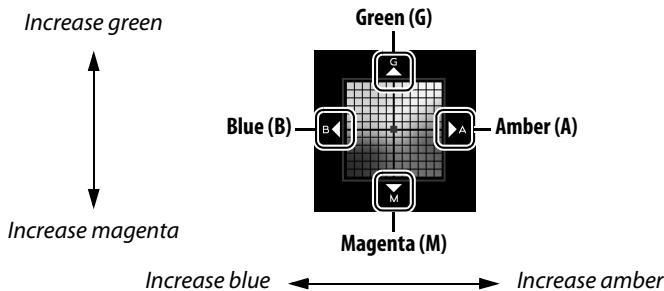

3 Press **OK**.

Press **OK** to save settings and return to the shooting menu. If white balance has been fine-tuned, an asterisk (“*”) will be displayed in the control panel.

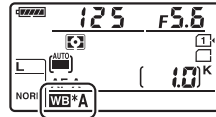

■ ■ The **WB** Button

At settings other than **☑ (Choose color temp.)** and **PRE (Preset manual)**, the **WB** button can be used to fine-tune white balance on the amber (A)–blue (B) axis (☐ 91; to fine-tune white balance when **☑** or **PRE** is selected, use the shooting menu as described on page 91). Six settings in both directions are available; each increment is equivalent to about 5 mired (☐ 93). Press the **WB** button and rotate the sub-command dial until the desired value is displayed in the control panel. Rotating the sub-command dial to the left increases the amount of amber (A). Rotating the sub-command dial to the right increases the amount of blue (B). At settings other than 0, an asterisk (“*”) appears in the control panel.

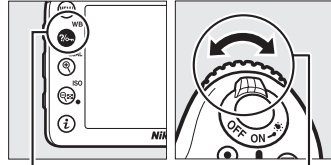

WB button

Sub-command dial

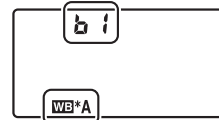

Control panel

White Balance Fine-Tuning

The colors on the fine-tuning axes are relative, not absolute. For example, moving the cursor to **B** (blue) when a “warm” setting such as  (incandescent) is selected for white balance will make photographs slightly “colder” but will not actually make them blue.

Color Temperature Fine-Tuning

When **Choose color temp.** is selected, you can view the color temperature while fine-tuning white balance.

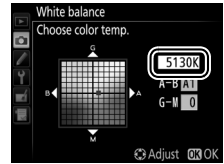

“Mired”

Any given change in color temperature produces a greater difference in color at low color temperatures than it would at higher color temperatures. For example, a change of 1000 K produces a much greater change in color at 3000 K than at 6000 K. Mired, calculated by multiplying the inverse of the color temperature by 10^6 , is a measure of color temperature that takes such variation into account, and as such is the unit used in color-temperature compensation filters. E.g.:

- 4000 K–3000 K (a difference of 1000 K)=83 mired
- 7000 K–6000 K (a difference of 1000 K)=24 mired

Choosing a Color Temperature

When **☑ (Choose color temp.)** is selected for white balance, color temperature can be selected by pressing the **WB** button and rotating the sub-command dial. The color temperature is displayed in the control panel.

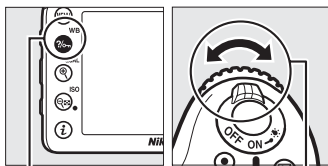

WB button Sub-command dial



Control panel

WB

☑ Choose Color Temperature

Note that the desired results will not be obtained with flash or fluorescent lighting. Choose **⚡ (Flash)** or **☀ (Fluorescent)** for these sources. With other light sources, take a test shot to determine if the selected value is appropriate.

✎ The White Balance Menu

Color temperature can also be selected in the white balance menu. Note that the color temperature with the **WB** button and the sub-command dial replaces the value selected in the white balance menu.

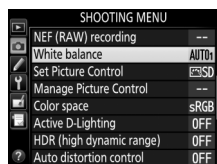

Preset Manual

Preset manual is used to record and recall custom white balance settings for shooting under mixed lighting or to compensate for light sources with a strong color cast. The camera can store up to six values for preset white balance in presets d-1 through d-6. Two methods are available for setting preset white balance:

Method	Description
Direct measurement	Neutral gray or white object is placed under lighting that will be used in final photo and white balance measured by camera (□ 95). In live view photography (□ 153), white balance can be measured in a selected area of the frame (spot white balance, □ 98).
Copy from existing photograph	White balance is copied from photo on memory card (□ 100).

■ Measuring a Value for White Balance During Viewfinder Photography

1 Light a reference object.

Place a neutral gray or white object under the lighting that will be used in the final photograph. In studio settings, a standard gray panel can be used as a reference object. Note that exposure is automatically increased by 1 EV when measuring white balance; in mode **M**, adjust exposure so that the exposure indicator shows ± 0 (□ 51).

2 Set white balance to PRE (Preset manual).

Press the  (WB) button and rotate the main command dial until **PRE** is displayed in the control panel.

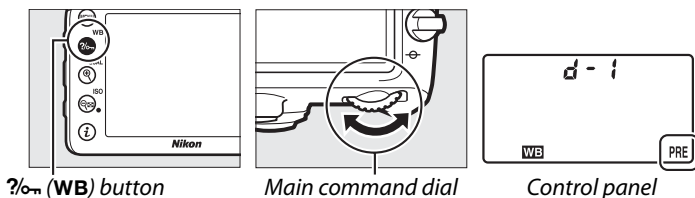

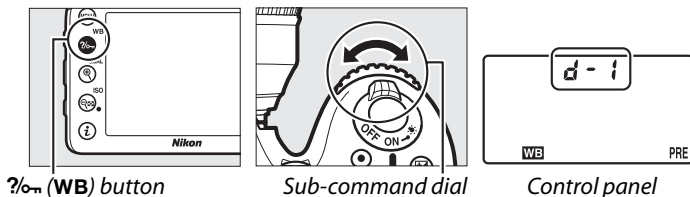

3 Select a preset.

Press the  (WB) button and rotate the sub-command dial until the desired white balance preset (d-1 to d-6) is displayed in the control panel.



4 Select direct measurement mode.

Release the  (WB) button briefly and then press the button until the PRE icon in the control panel starts to flash. A flashing  will also appear in the viewfinder. The displays will flash for about six seconds.

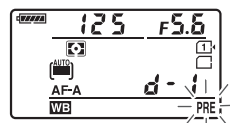

Control panel





Viewfinder

5 Measure white balance.

Before the indicators stop flashing, frame the reference object so that it fills the viewfinder and press the shutter-release button all the way down. The camera will measure a value for white balance and store it in the preset selected in Step 3. No photograph will be recorded; white balance can be measured accurately even when the camera is not in focus.



Protected Presets

If the current preset is protected ( 103),  will flash in the control panel and viewfinder if you attempt to measure a new value.

6 Check the results.

If the camera was able to measure a value for white balance, **Good** will flash in the control panel for about six seconds, while the viewfinder will show a flashing **Good**.

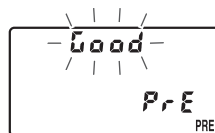

Control panel



Viewfinder

If lighting is too dark or too bright, the camera may be unable to measure white balance. A flashing **no Good** will appear in the control panel and viewfinder for about six seconds. Press the shutter-release button halfway to return to Step 5 and measure white balance again.

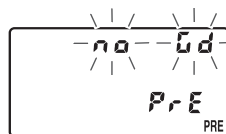

Control panel



Viewfinder

Direct Measurement Mode

If no operations are performed during viewfinder photography while the displays are flashing, direct measurement mode will end in the time selected for Custom Setting c2 (**Standby timer**, □ 237).

Measuring Preset White Balance (Viewfinder Photography)

Preset manual white balance can not be measured while HDR or multiple exposure photography (□ 115, 141) is in progress or when **Record movies** is selected for Custom Setting g4 (**Assign shutter button**, □ 260) and the live view selector is rotated to .

Selecting a Preset

Selecting **Preset manual** for the **White balance** option in the shooting menu displays the dialog shown at right; highlight a preset and press . If no value currently exists for the selected preset, white balance will be set to 5200 K, the same as **Direct sunlight**.



■ ■ Measuring White Balance During Live View (Spot White Balance)

In live view, white balance can be measured in a selected area of the frame, eliminating the need to prepare a reference object or change lenses during telephoto photography.

1 Press the **Lv** button.

The mirror will be raised and the view through the lens will be displayed in the camera monitor.

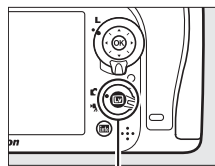

Lv button

2 Set white balance to PRE (Preset manual).

Press the **WB** button and rotate the main command dial until **PRE** is displayed in the monitor.

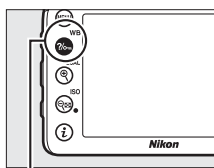

WB button

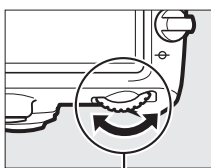

Main command dial



Monitor

3 Select a preset.

Press the **WB** button and rotate the sub-command dial until the desired white balance preset (d-1 to d-6) is displayed in the monitor.

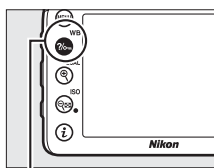

WB button

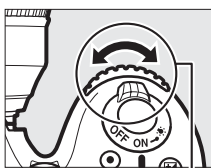

Sub-command dial



Monitor

4 Select direct measurement mode.

Release the **WB** button briefly and then press the button until the **PRE** icon in the monitor starts to flash. A spot white balance target (□) will be displayed at the selected focus point.

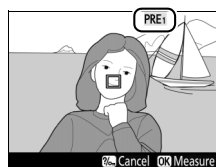

Monitor

5 Position the target over a white or grey area.

While **PRE** flashes in the display, use the multi selector to position the  over a white or grey area of the subject.



6 Measure white balance.

Press **OK** or press the shutter-release button all the way down to measure white balance. The time available to measure white balance is that selected for Custom Setting c4 (**Monitor off delay**) > **Live view** (📖 238).



When **Preset manual** is selected for **White balance** in the shooting menu, the position of the target used to measure preset white balance will be displayed on presets recorded during live view photography.



Measuring Preset White Balance (Live View Photography)

When **Record movies** is selected for Custom Setting g4 (**Assign shutter button**, 📖 260) and the live view selector is rotated to , preset manual white balance is measured using the **OK** button in place of the shutter-release button. Preset manual white balance can not set while an HDR exposure is in progress (📖 115).

■ Copying White Balance from a Photograph

Follow the steps below to copy a value for white balance from an existing photograph to a selected preset.

1 Select PRE (Preset manual) for White balance in the shooting menu.

Press the MENU button and select **White balance** in the shooting menu. Highlight **Preset manual** and press ►.

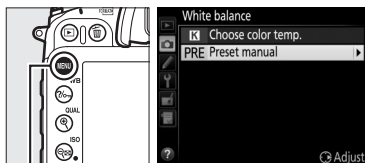

MENU button

2 Select a destination.

Highlight the destination preset (d-1 to d-6) and press  (ISO).



 (ISO) button

3 Choose Select image.

Highlight **Select image** and press ►.

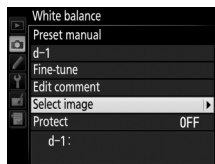



4 Highlight a source image.

Highlight the source image.



5 Press .

Press  to copy the white balance value for the highlighted photograph to the selected preset. If the highlighted photograph has a comment ( 266), the comment will be copied to the comment for the selected preset.



Choosing a Source Image

To view the image highlighted in Step 4 full frame, press and hold the **QUAL** button.



QUAL button

To view images in other locations, hold the **BKT** button and press **▲**. The dialog shown at right will be displayed; select the desired card and folder (186).

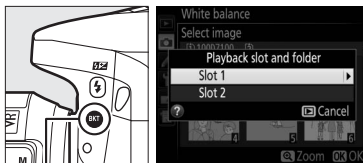

BKT button

Choosing a White Balance Preset

Press **▲** to highlight the current white balance preset (d-1 – d-6) and press **▶** to select another preset.

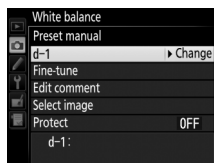

Fine-Tuning Preset White Balance

The selected preset can be fine-tuned by selecting **Fine-tune** and adjusting white balance as described on page 91.

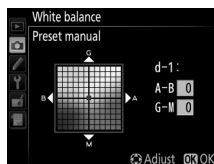

■ ■ Entering a Comment

Follow the steps below to enter a descriptive comment of up to thirty-six characters for a selected white balance preset.

1 Select PRE (Preset manual).

Highlight **Preset manual** in the white balance menu and press ►.

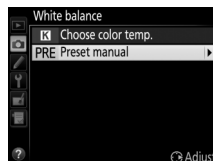

2 Select a preset.

Highlight the desired preset and press  (ISO).

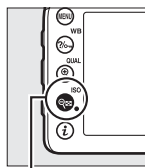

 (ISO) button



3 Select Edit comment.

Highlight **Edit comment** and press ►.

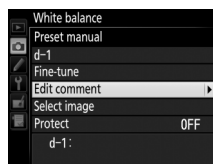

4 Edit the comment.

Edit the comment as described on page 111.



■ Protecting a White Balance Preset

Follow the steps below to protect the selected white balance preset. Protected presets can not be modified and the **Fine-tune** and **Edit comment** options can not be used.

1 Select PRE (Preset manual).

Highlight **Preset manual** in the white balance menu and press ►.

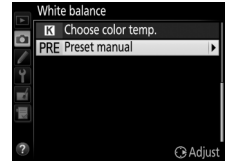

2 Select a preset.

Highlight the desired preset and press  (ISO).

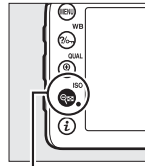

 (ISO) button

3 Select Protect.

Highlight **Protect** and press ►.

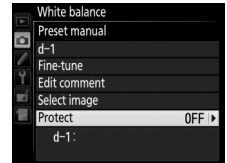

4 Select On.

Highlight **On** and press  to protect the selected white balance preset. To remove protection, select **Off**.

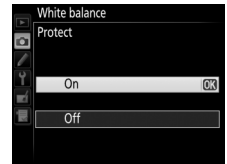

WB





Image Enhancement

Picture Controls

(P, S, A, and M Modes Only)

Nikon's unique Picture Control system makes it possible to share image processing settings, including sharpening, contrast, brightness, saturation, and hue, among compatible devices and software.

Selecting a Picture Control

The camera offers a choice of preset Picture Controls. In **P**, **S**, **A**, and **M** modes, you can choose a Picture Control according to the subject or type of scene (in other modes, the camera selects a Picture Control automatically).

Option	Description
Standard	Standard processing for balanced results. Recommended for most situations.
Neutral	Minimal processing for natural results. Choose for photographs that will later be extensively processed or retouched.
Vivid	Pictures are enhanced for a vivid, photoprint effect. Choose for photographs that emphasize primary colors.
Monochrome	Take monochrome photographs.
Portrait	Process portraits for skin with natural texture and a rounded feel.
Landscape	Produces vibrant landscapes and cityscapes.

1 Display Picture Controls.

To display the menus, press the **MENU** button. Highlight **Set Picture Control** in the shooting menu and press **▶** to display a list of Picture Controls.

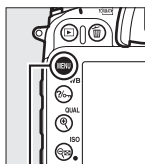

MENU button

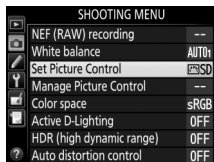

2 Choose a Picture Control.

Highlight the desired Picture Control and press **OK**.

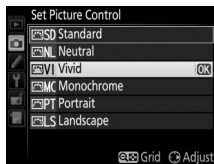

Custom Picture Controls

Custom Picture Controls are created through modifications to existing Picture Controls using the **Manage Picture Control** option in the shooting menu (📖 110). Custom Picture Controls can be saved to a memory card for sharing among other cameras of the same model and compatible software (📖 112).

The Picture Control Indicator

The current Picture Control is shown in the information display when the  button is pressed.

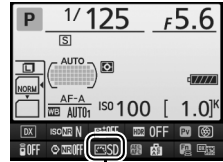

*Picture Control
indicator*



Modifying Picture Controls

Existing preset or custom Picture Controls (☐ 110) can be modified to suit the scene or the user's creative intent. Choose a balanced combination of sharpening, contrast, and saturation using **Quick adjust**, or make manual adjustments to individual settings.

1 Select a Picture Control.

Highlight the desired Picture Control in the Picture Control list (☐ 105) and press ►.

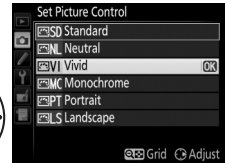

2 Adjust settings.

Press ▲ or ▼ to highlight the desired setting (☐ 108) and press ◀ or ▶ to choose a value. Repeat this step until all settings have been adjusted, or select **Quick adjust** to choose a preset combination of settings. Default settings can be restored by pressing the  (FORMAT) button.

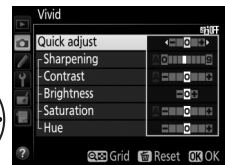

3 Press OK.

Modifications to Original Picture Controls

Picture Controls that have been modified from default settings are indicated by an asterisk ("*").

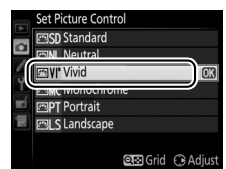

Picture Control Settings

Option	Description
Quick adjust	Choose from options between -2 and +2 to reduce or exaggerate the effect of the selected Picture Control by adjusting sharpening, contrast, and saturation (note that this resets all manual adjustments). For example, choosing positive values for Vivid makes pictures more vivid. Not available with Neutral , Monochrome or custom Picture Controls.
Manual adjustments (all Picture Controls)	Sharpening Control the sharpness of outlines. Select A to adjust sharpening automatically according to the type of scene, or choose from values between 0 (no sharpening) and 9 (the higher the value, the greater the sharpening).
	Contrast Select A to adjust contrast automatically according to the type of scene, or choose from values between -3 and +3 (choose lower values to prevent highlights in portrait subjects from being “washed out” in direct sunlight, higher values to preserve detail in misty landscapes and other low-contrast subjects).
	Brightness Choose -1 for reduced brightness, +1 for enhanced brightness. Does not affect exposure.
Manual adjustments (non-monochrome only)	Saturation Control the vividness of colors. Select A to adjust saturation automatically according to the type of scene, or choose from values between -3 and +3 (lower values reduce saturation and higher values increase it).
	Hue Choose negative values (to a minimum of -3) to make reds more purple, blues more green, and greens more yellow, positive values (up to +3) to make reds more orange, greens more blue, and blues more purple.
Manual adjustments (monochrome only)	Filter effects Simulate the effect of color filters on monochrome photographs. Choose from Off , yellow , orange , red , and green (☐ 109).
	Toning Choose the tint used in monochrome photographs from B&W (black-and-white), Sepia , Cyanotype (blue-tinted monochrome), Red , Yellow , Green , Blue Green , Blue , Purple Blue , Red Purple (☐ 109).

“A” (Auto)

Results for auto sharpening, contrast, and saturation vary with exposure and the position of the subject in the frame. Use a type G or D lens for best results.

Custom Picture Controls

The options available with custom Picture Controls are the same as those on which the custom Picture Control was based.

The Picture Control Grid

Pressing the **Q** (ISO) button in Step 2 on page 107 displays a Picture Control grid showing the contrast and saturation for the selected Picture Control in relation to the other Picture Controls (only contrast is displayed when **Monochrome** is selected). Release the **Q** (ISO) button to return to the Picture Control menu.

The icons for Picture Controls that use auto contrast and saturation are displayed in green in the Picture Control grid, and lines appear parallel to the axes of the grid.

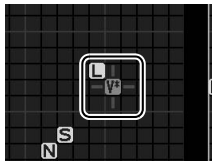
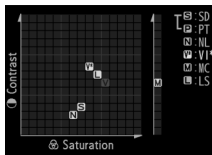

Previous Settings

The line under the value displayed in the Picture Control setting menu indicates the previous value for the setting. Use this as a reference when adjusting settings.

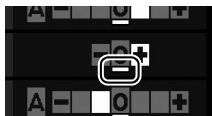

Filter Effects (Monochrome Only)

The options in this menu simulate the effect of color filters on monochrome photographs. The following filter effects are available:

Option	Description
Y Yellow	Enhances contrast. Can be used to tone down the brightness of the sky in landscape photographs. Orange produces more contrast than yellow, red more contrast than orange.
O Orange	
R Red	
G Green	Softens skin tones. Can be used for portraits.

Note that the effects achieved with **Filter effects** are more pronounced than those produced by physical glass filters.

Toning (Monochrome Only)

Pressing **▼** when **Toning** is selected displays saturation options. Press **◀** or **▶** to adjust saturation. Saturation control is not available when **B&W** (black-and-white) is selected.

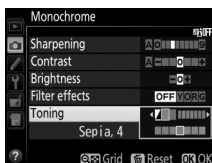

Creating Custom Picture Controls

The Picture Controls supplied with the camera can be modified and saved as custom Picture Controls.

1 Select Manage Picture Control in the shooting menu.

To display the menus, press the MENU button. Highlight **Manage Picture Control** in the shooting menu and press ►.

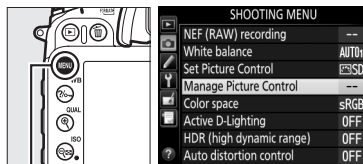

MENU button

2 Select Save/edit.

Highlight **Save/edit** and press ►.

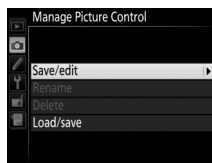

3 Select a Picture Control.

Highlight an existing Picture Control and press ►, or press **OK** to proceed to Step 5 to save a copy of the highlighted Picture Control without further modification.

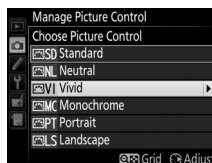

4 Edit the selected Picture Control.

See page 108 for more information. To abandon any changes and start over from default settings, press the **FORMAT** button. Press **OK** when settings are complete.

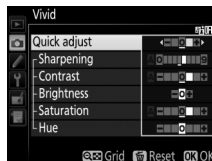

5 Select a destination.

Choose a destination for the custom Picture Control (C-1 through C-9) and press ►.

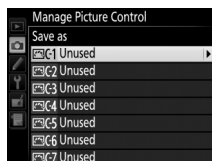

6 Name the Picture Control.

The text-entry dialog shown at right will be displayed. By default, new Picture Controls are named by adding a two-digit number (assigned automatically) to the name of the existing Picture Control; to use the default name, proceed to Step 7. To move the cursor in the name area, hold the **ISO** button and press **◀** or **▶**. To enter a new letter at the current cursor position, use the multi selector to highlight the desired character in the keyboard area and press **OK**. To delete the character at the current cursor position, press the **FORMAT** button.



Custom Picture Control names can be up to nineteen characters long. Any characters after the nineteenth will be deleted.

7 Press **QUAL**.

Press the **QUAL** button to save changes and exit. The new Picture Control will appear in the Picture Control list.

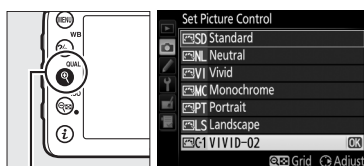

QUAL button

Manage Picture Control > Rename

Custom Picture Controls can be renamed at any time using the **Rename** option in the **Manage Picture Control** menu.

Manage Picture Control > Delete

The **Delete** option in the **Manage Picture Control** menu can be used to delete selected custom Picture Controls when they are no longer needed.

The Original Picture Control Icon

The original preset Picture Control on which the custom Picture Control is based is indicated by an icon in the top right corner of the edit display.

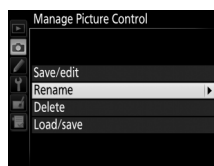

Original Picture Control icon



Sharing Custom Picture Controls

Custom Picture Controls created using the Picture Control Utility available with ViewNX 2 or optional software such as Capture NX 2 can be copied to a memory card and loaded into the camera, or custom Picture Controls created with the camera can be copied to the memory card to be used in other D7100 cameras and software and then deleted when no longer needed.

To copy custom Picture Controls to or from the memory card, or to delete custom Picture Controls from the memory card, highlight **Load/save** in the **Manage Picture Control** menu and press **▶**. The following options will be displayed:

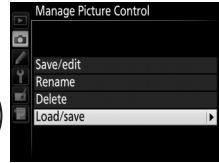

- **Copy to camera:** Copy custom Picture Controls from the memory card to custom Picture Controls C-1 through C-9 on the camera and name them as desired.
- **Delete from card:** Delete selected custom Picture Controls from the memory card. The confirmation dialog shown at right will be displayed before a Picture Control is deleted; to delete the selected Picture Control, highlight **Yes** and press **OK**.
- **Copy to card:** Copy a custom Picture Control (C-1 through C-9) from the camera to a selected destination (1 through 99) on the memory card.



Saving Custom Picture Controls

Up to 99 custom Picture Controls can be stored on the memory card at any one time. The memory card can only be used to store user-created custom Picture Controls. The preset Picture Controls supplied with the camera (□ 105) can not be copied to the memory card, renamed, or deleted.

The options in the **Manage Picture Control** menu apply only to the memory card in Slot 1. Custom Picture Controls can not be deleted from or copied to or from the card in Slot 2.

Preserving Detail in Highlights and Shadows

Active D-Lighting

(P, S, A, and M Modes Only)

Active D-Lighting preserves details in highlights and shadows, creating photographs with natural contrast. Use for high contrast scenes, for example when photographing brightly lit outdoor scenery through a door or window or taking pictures of shaded subjects on a sunny day. It is most effective when used with matrix metering (☐ 83).



Active D-Lighting off



Active D-Lighting: 晴 A Auto



“Active D-Lighting” Versus “D-Lighting”

The **Active D-Lighting** option in the shooting menu adjusts exposure before shooting to optimize the dynamic range, while the **D-Lighting** option in the retouch menu (☐ 276) brightens shadows in images after shooting.

To use Active D-Lighting:

1 Select **Active D-Lighting** in the shooting menu.

To display the menus, press the **MENU** button. Highlight **Active D-Lighting** in the shooting menu and press ►.

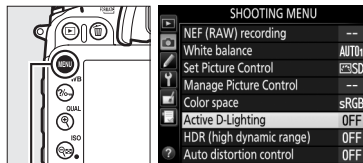

MENU button

2 Choose an option.

Highlight **Auto**, **Extra high**, **High**, **Normal**, **Low**, or **Off** and press **OK**. If **Auto** is selected, the camera will automatically adjust Active D-Lighting according to shooting conditions (note, however, that the effects may not be visible in mode **M** and when center-weighted or spot metering is used).

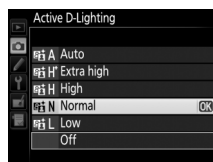

✓ **Active D-Lighting**

Active D-Lighting can not be used with movies. Noise (randomly-spaced bright pixels, fog, or lines) may appear in photographs taken with Active D-Lighting. Uneven shading may be visible with some subjects. Active D-Lighting can not be used at ISO sensitivities of Hi 0.3 or above.

✍ **See Also**

When **ADL bracketing** is selected for Custom Setting e6 (**Auto bracketing set**, 251), the camera varies Active D-Lighting over a series of shots (139). For information on using the **Fn** button or depth-of-field preview button and a command dial to select an Active D-Lighting option, see page 255.

High Dynamic Range (HDR)

(P, S, A, and M Modes Only)

Used with high-contrast subjects, High Dynamic Range (HDR) preserves details in highlights and shadows by combining two shots taken at different exposures. HDR is most effective when used with matrix metering (☐ 83; with other metering methods and a non-CPU lens, a strength of **AUTO Auto** is equivalent to **NORM Normal**). It can not be used to record NEF (RAW) images. While HDR is in effect, movie recording (☐ 161), flash lighting, bracketing (☐ 133), and multiple exposure (☐ 141) can not be used and shutter speeds of Bulb (b u l b) and Time (- -) are not available.



1 Select HDR (high dynamic range).

Press the **MENU** button to display the menus. Highlight **HDR (high dynamic range)** in the shooting menu and press **▶**.

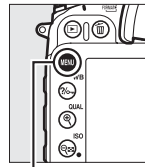

MENU button



2 Select a mode.

Highlight **HDR mode** and press **▶**.

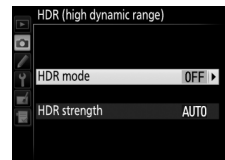

Highlight one of the following and press **OK**.

- To take a series of HDR photographs, select **ON** **On (series)**. HDR shooting will continue until you select **Off** for **HDR mode**.
- To take one HDR photograph, select **On (single photo)**. Normal shooting will resume automatically after you have created a single HDR photograph.
- To exit without creating additional HDR photographs, select **Off**.

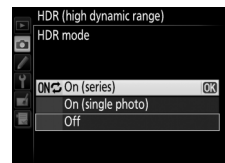

If **On (series)** or **On (single photo)** is selected, a **HDR** icon will be displayed in the control panel.

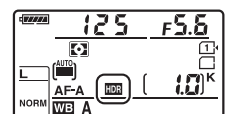

3 Choose the HDR strength.

To choose the difference in exposure between the two shots (HDR strength), highlight **HDR strength** and press **▶**.

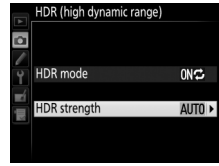

Highlight **AUTO Auto**, **HIGH Extra high**, **HIGH High**, **NORM Normal**, or **LOW Low** and press **⊙**. If **AUTO Auto** is selected, the camera will automatically adjust HDR strength according to shooting conditions.



4 Frame a photograph, focus, and shoot.

The camera takes two exposures when the shutter-release button is pressed all the way down. **Ⓜ HDR** will flash in the control panel and **Ⓜ Hdr** in the viewfinder while the images are combined; no photographs can be taken until recording is complete. Regardless of the option currently selected for release mode, only one photograph will be taken each time the shutter-release button is pressed.

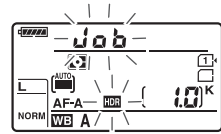

Control panel



Viewfinder

If **On (series)** is selected, HDR will only turn off when **Off** is selected for **HDR mode**; if **On (single photo)** is selected, HDR turns off automatically after the photograph is taken. The **HDR** icon clears from the display when HDR shooting ends.



Framing HDR Photographs

The edges of the image will be cropped out. The desired results may not be achieved if the camera or subject moves during shooting. Depending on the scene, the effect may not be visible, shadows may appear around bright objects, or halos may appear around dark objects. Uneven shading may be visible with some subjects.

Interval Timer Photography

If **On (series)** is selected for **HDR mode** before interval timer shooting begins, the camera will continue to shoot HDR photographs at the selected interval (if **On (single photo)** is selected, interval timer shooting will end after a single shot).

See Also

HDR can also be adjusted using the **Fn** or depth-of-field preview button and the command dials. See Custom Setting f2 (**Assign Fn button**,  255) or f3 (**Assign preview button**,  255).





Flash Photography

Using the Built-in Flash

The built-in flash has a Guide Number (GN) 12/39 (m/ft, ISO 100, 20 °C/68 °F) and provides coverage for the angle of view of a 16 mm lens. It can be used not only when natural lighting is inadequate but to fill in shadows and backlit subjects or to add a catch light to the subject's eyes.

■ Using the Built-in Flash: , , , , , , and Modes

1 Choose a flash mode ( 120).

2 Take pictures.

The flash will pop up as required when the shutter-release button is pressed halfway, and fire when a photograph is taken. *If the flash does not pop up automatically, DO NOT attempt to raise it by hand. Failure to observe this precaution could damage the flash.*

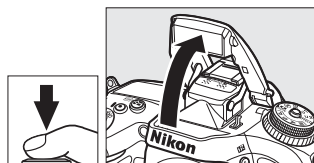

■ Using the Built-in Flash: P, S, A, M, and Modes

1 Raise the flash.



Press the  () button to raise the flash.

2 Choose a flash mode (P, S, A, and M modes only;  120).

3 Take pictures.

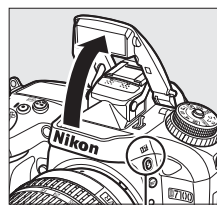
The flash will fire whenever a picture is taken.



























 () button

Metering



Select matrix or center-weighted metering to activate i-TTL balanced fill-flash for digital SLR. Standard i-TTL flash for digital SLR is activated automatically when spot metering is selected ( 122).

Flash Mode



The flash modes available vary with shooting mode:

AUTO,  ,  ,  ,  ,  , 			 
 Auto	 Auto + slow sync + red-eye reduction	 Fill flash	
 Auto + red-eye reduction	 Auto + slow sync		
 Off	 Off		
P, A		S, M	
 Fill flash	 Fill flash		
 Red-eye reduction	 Red-eye reduction		
 Slow sync + red-eye reduction	 Rear-curtain sync		
 Slow sync			
 Rear curtain + slow sync*			

* **SLOW** is displayed when setting is complete.

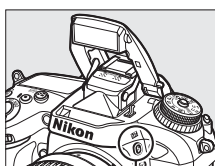
To choose a flash mode, press the  () button and rotate the main command dial until the desired setting is displayed in the control panel.



 () button



Main command dial

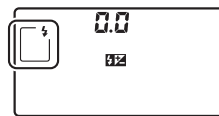

Control panel





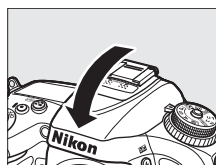



Lowering the Built-in Flash

To save power when the flash is not in use, press it gently downward until the latch clicks into place.





Default Flash Modes

Default flash modes are shown below.

Mode	Default	Mode	Default
     	Auto		Auto+slow sync
	Auto+red-eye reduction	¶1, P, S, A, M	Fill flash

Flash Modes

The flash modes listed on the previous page may combine one or more of the following settings, as shown by the flash mode icon:

- **AUTO (auto flash):** When lighting is poor or subject is backlit, flash pops up automatically when shutter-release button is pressed halfway and fires as required.
-  **(red-eye reduction):** Use for portraits. Red-eye reduction lamp lights before flash fires, reducing “red-eye.”
-  **(off):** Flash does not fire even when lighting is poor or subject is backlit.
- **SLOW (slow sync):** Shutter speed slows automatically to capture background lighting at night or under low light. Use to include background lighting in portraits.
- **REAR (rear-curtain sync):** Flash fires just before shutter closes, creating a stream of light behind moving light sources (below at right). If this icon is not displayed, flash will fire as the shutter opens (front-curtain sync; the effect this produces with moving light sources is shown below at left).



Front-curtain sync



Rear-curtain sync

The Built-in Flash

For information on the lenses that can be used with the built-in flash, see page 299. Remove lens hoods to prevent shadows. The flash has a minimum range of 0.6 m (2 ft) and can not be used in the macro range of zoom lenses with a macro function. i-TTL flash control can be used at ISO sensitivities between 100 and 6400. At values over 6400, the desired results may not be achieved at some ranges or aperture settings.

If the flash fires in continuous release mode ( 57), only one picture will be taken each time the shutter-release button is pressed.

The shutter release may be briefly disabled to protect the flash after it has been used for several consecutive shots. The flash can be used again after a short pause.



Shutter Speeds Available with the Built-in Flash

The following shutter speeds are available with the built-in flash.











Mode	Shutter speed	Mode	Shutter speed
AUTO, P, A, S, M, B, WB, M	$1/250-1/60$ s	S	$1/250-30$ s
M, H	$1/250-1/125$ s	M	$1/250-30$ s, b u l b
B	$1/250-1$ s		

Flash Control Mode

The camera supports the following i-TTL flash control modes:

- **i-TTL balanced fill-flash for digital SLR:** Flash emits series of nearly invisible preflashes (monitor preflashes) immediately before main flash. Preflashes reflected from objects in all areas of frame are picked up by 2016-pixel RGB sensor and are analyzed in combination with range information from metering system to adjust flash output for natural balance between main subject and ambient background lighting. If type G or D lens is used, distance information is included when calculating flash output. Precision of calculation can be increased for non-CPU lenses by providing lens data (focal length and maximum aperture; see [□ 149](#)). Not available when spot metering is used.
- **Standard i-TTL flash for digital SLR:** Flash output adjusted to bring lighting in frame to standard level; brightness of background is not taken into account. Recommended for shots in which main subject is emphasized at expense of background details, or when exposure compensation is used. Standard i-TTL flash for digital SLR is activated automatically when spot metering is selected.

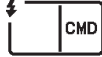
The flash control mode for the built-in flash can be selected using Custom Setting e3 (**Flash cntrl for built-in flash**, [□ 246](#)). The information display shows the flash control mode for the built-in flash as follows:

	Flash sync	Auto FP (□ 244)
 i-TTL	 	—
Manual	 	—
Repeating flash	 	—
Commander mode	 	

Aperture, Sensitivity, and Flash Range

Flash range varies with sensitivity (ISO equivalency) and aperture.

Aperture at ISO equivalent of							Approximate range	
100	200	400	800	1600	3200	6400	m	ft
1.4	2	2.8	4	5.6	8	11	0.7–8.5	2 ft 4 in.–27 ft 11 in.
2	2.8	4	5.6	8	11	16	0.6–6.0	2 ft–19 ft 8 in.
2.8	4	5.6	8	11	16	22	0.6–4.2	2 ft–13 ft 9 in.
4	5.6	8	11	16	22	32	0.6–3.0	2 ft–9 ft 10 in.
5.6	8	11	16	22	32	—	0.6–2.1	2 ft–6 ft 11 in.
8	11	16	22	32	—	—	0.6–1.5	2 ft–4 ft 11 in.
11	16	22	32	—	—	—	0.6–1.1	2 ft–3 ft 7 in.
16	22	32	—	—	—	—	0.6–0.8	2 ft–2 ft 7 in.

The built-in flash has a minimum range of 0.6 m (2 ft).



In mode **P**, the maximum aperture (minimum f-number) is limited according to ISO sensitivity, as shown below:

Maximum aperture at ISO equivalent of:						
100	200	400	800	1600	3200	6400
2.8	3.5	4	5	5.6	7.1	8

If the maximum aperture of the lens is smaller than given above, the maximum value for aperture will be the maximum aperture of the lens.

See Also

See page 125 for information on locking flash value (FV) for a metered subject before recomposing a photograph.

For information on auto FP high-speed sync and choosing a flash sync speed, see Custom Setting e1 (**Flash sync speed**,  244). For information on choosing the slowest shutter speed available when using the flash, see Custom Setting e2 (**Flash shutter speed**,  245). For information on flash control and using the built-in flash in commander mode, see Custom Setting e3 (**Flash cntrl for built-in flash**,  246).

See page 303 for information on using optional flash units.





Flash Compensation

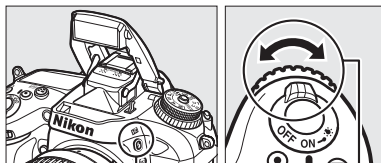

(P, S, A, and M Modes Only)

Flash compensation is used to alter flash output by from -3 EV to $+1$ EV in increments of $\frac{1}{3}$ EV, changing the brightness of the main subject relative to the background. Flash output can be increased to make the main subject appear brighter, or reduced to prevent unwanted highlights or reflections.

Press the  button and rotate the sub-command dial until the desired value is displayed in the control panel. In general, choose positive values to make the main subject brighter, negative values to make it darker.



 button Sub-command dial

At values other than ± 0.0 , a  icon will be displayed in the control panel and viewfinder after you release the  button. The current value for flash compensation can be confirmed by pressing the  button.

Normal flash output can be restored by setting flash compensation to ± 0.0 . Flash compensation is not reset when the camera is turned off.

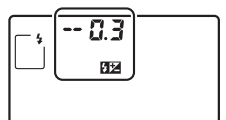

± 0 EV

 button pressed)



-0.3 EV





$+1.0$ EV

Optional Flash Units

Flash compensation is also available with optional SB-910, SB-900, SB-800, SB-700, SB-600, SB-400, and SB-R200 flash units. The SB-910, SB-900, SB-800, SB-700, and SB-600 also allow flash compensation to be set using the controls on the flash unit; the value selected with the flash unit is added to the value selected with the camera.

See Also

For information on choosing the size of the increments available for flash compensation, see Custom Setting b2 (**EV steps for exposure cntrl**,  234). For information on choosing how flash and exposure compensation combine, see Custom Setting e4 (**Exposure comp. for flash**,  250). For information on automatically varying flash level over a series of shots, see page 133.

FV Lock

This feature is used to lock flash output, allowing photographs to be recomposed without changing the flash level and ensuring that flash output is appropriate to the subject even when the subject is not positioned in the center of the frame. Flash output is adjusted automatically for any changes in ISO sensitivity and aperture.







To use FV lock:

1 Assign FV lock to the Fn button.

Select **FV lock** for Custom Setting f2 (**Assign Fn button** > **Press**, 253).



2 Raise the flash.

In **P**, **S**, **A**, **M**, and **Hi** modes, the flash can be raised by pressing the  button. In **AUTO**, , , , , , and  modes, the flash will pop up automatically when required.

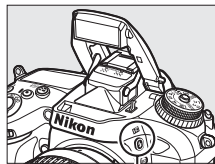



 button

3 Focus.

Position the subject in the center of the frame and press the shutter-release button halfway to focus.



4 Lock flash level.

After confirming that the flash ready indicator () is displayed in the viewfinder, press the **Fn** button. The flash will emit a monitor preflash to determine the appropriate flash level. Flash output will be locked at this level and FV lock icons () will appear in the viewfinder.

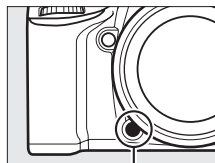

Fn button



5 Recompose the photograph.

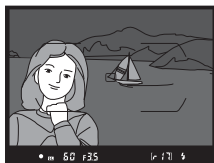

6 Take the photograph.

Press the shutter-release button the rest of the way down to shoot. If desired, additional pictures can be taken without releasing FV lock.

7 Release FV lock.

Press the **Fn** button to release FV lock. Confirm that the FV lock icon (AE-L) is no longer displayed in the viewfinder.

✓ Using FV Lock with the Built-in Flash

FV lock is only available with the built-in flash when TTL is selected for Custom Setting e3 (**Flash cntrl for built-in flash**, □ 246).

✍ Using FV Lock with Optional Flash Units

FV lock is also available with optional flash units in TTL and (where supported) monitor pre-flash AA and monitor pre-flash A flash control modes. Note that when commander mode is selected for Custom Setting e3 (**Flash cntrl for built-in flash**, □ 246), you will need to set the flash control mode for the master or at least one remote group to TTL or AA.

✍ Metering

The metering areas for FV lock when using optional flash unit are as follows:

Flash unit	Flash mode	Metered area
Stand-alone flash unit	i-TTL	4-mm circle in center of frame
	AA	Area metered by flash exposure meter
Used with other flash units (Advanced Wireless Lighting)	i-TTL	Entire frame
	AA	Area metered by flash exposure meter
	A (master flash)	

✍ See Also

For information on using the depth-of-field preview or $\overline{\text{AE-L}}$ **AE-L/AF-L** button for FV lock, see Custom Setting f3 (**Assign preview button**, □ 255) or Custom Setting f4 (**Assign AE-L/AF-L button**, □ 256).



Remote Control Photography

Using an Optional ML-L3 Remote Control

The optional ML-L3 remote control (☞ 309) can be used to reduce camera shake or for self-portraits.

1 Select Remote control mode (ML-L3).

Press the **MENU** button to display the menus. Highlight **Remote control mode (ML-L3)** in the shooting menu and press ►.



MENU button

2 Choose a remote control mode.

Highlight one of the following options and press **OK**.

Option	Description
Delayed remote	Shutter is released 2 s after ML-L3 shutter-release button is pressed.
Quick-response remote	Shutter is released when ML-L3 shutter-release button is pressed.
Remote mirror-up	Press ML-L3 shutter-release button once to raise mirror, again to release shutter and take photograph. Prevents blur caused by camera moving when mirror is raised.
Off	The shutter can not be released using the ML-L3.

3 Frame the photograph.

Mount the camera on a tripod or place the camera on a stable, level surface.

Release Mode

When an optional ML-L3 remote control is used, the release mode selected with the release mode dial (☞ 57) is ignored in favor of the option selected for **Remote control mode (ML-L3)** in the shooting menu.

4 Take the photograph.

From a distance of 5 m (16 ft) or less, aim the transmitter on the ML-L3 at either of the infrared receivers on the camera (☞ 3, 5) and press the ML-L3 shutter-release button. *In delayed remote mode*, the self-timer lamp will light for about two seconds before the shutter is released. *In quick-response remote mode*, the self-timer lamp will flash after the shutter has been released. *In remote mirror-up mode*, pressing the ML-L3 shutter-release button once raises the mirror; the shutter will be released and the self-timer lamp will flash after 30 s or when the button is pressed a second time.

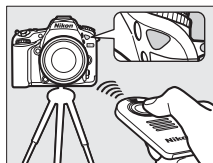

✔ Before Using Optional ML-L3 Remote Controls

Before using the remote control for the first time, remove the clear plastic battery-insulator sheet.

✍ Using the Built-in Flash

Before taking a photograph with the flash in **P**, **S**, **A**, **M**, or **Ⓜ** modes, press the **⚡** (**Ⓜ**) button to raise the flash and wait for the **⚡** indicator to be displayed in the viewfinder (☞ 119). Shooting will be interrupted if the flash is raised while remote control mode is in effect. If the flash is required, the camera will only respond to the ML-L3 shutter-release button once the flash has charged. In auto, scene, and special effects modes in which the flash pops up automatically, the flash will begin charging when remote control mode is selected; once the flash is charged, it will automatically pop up and fire when required.

In flash modes that support red-eye reduction, the red-eye reduction lamp will light for about one second before the shutter is released. In delayed remote mode, the self-timer lamp will light for two seconds, followed by the red-eye reduction lamp which light for one second before the shutter is released.

✍ Focusing in Remote Control Mode

The camera will not adjust focus in remote mirror-up mode or when continuous-servo autofocus is selected; note however that if any autofocus mode is selected, you can focus by pressing the camera shutter-release button halfway before shooting (pressing the button all the way down will not release the shutter). If auto- or single-servo autofocus is selected or the camera is in live view in delayed or quick-response remote mode, the camera will automatically adjust focus before shooting; if the camera is unable to focus in viewfinder photography, it will return to stand-by without releasing the shutter.

✍ Remote Mirror-up Mode

Metering is not performed in remote mirror-up mode. Photos can not be framed in the viewfinder while the mirror is raised.

Exiting Remote Control Mode

Remote control is cancelled automatically if no photograph is taken before the time selected for Custom Setting c5 (**Remote on duration (ML-L3)**, □ 238), **Off** is selected for **Remote control mode (ML-L3)**, a two-button reset is performed, or shooting options are reset using **Reset shooting menu**.

Assign Shutter Button

If **Record movies** is selected for Custom Setting g4 (**Assign shutter button**, □ 260), the ML-L3 can not be used when the live view selector is rotated to .

Cover the Viewfinder

To prevent light entering via the viewfinder interfering with exposure, remove the rubber eyecup and cover the viewfinder with the supplied DK-5 eyepiece cap (□ 60).

See Also

For information on choosing the length of time the camera will remain in stand-by mode waiting for a signal from the remote control, see Custom Setting c5 (**Remote on duration (ML-L3)**; □ 238). For information on controlling the beeps that sound when the remote control is used, see Custom Setting d1 (**Beep**; □ 238).



Wireless Remote Controllers

When the camera is used with optional WR-1 (☐ 309) and WR-R10/WR-T10 (☐ 309) wireless remote controllers, the shutter-release buttons on the WR-1 and WR-T10 perform the same functions as the camera shutter-release button, allowing remote continuous and self-timer photography.

WR-1 Wireless Remote Controllers

When a WR-1 is connected to the camera accessory terminal, the shutter can be released using another WR-1.

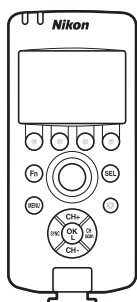

Pressing the shutter-release button on the transmitter...

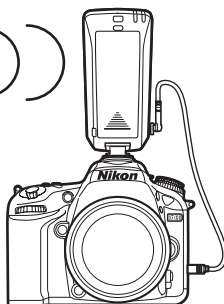
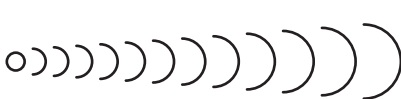

...releases the shutter on the cameras connected to the receivers.

WR-R10/WR-T10 Wireless Remote Controllers

When a WR-R10 (transceiver) is connected to the camera, the shutter can be released using a WR-T10 (transmitter).

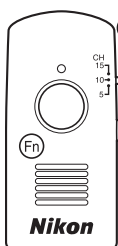

Pressing the shutter-release button on the WR-T10 (transmitter)...

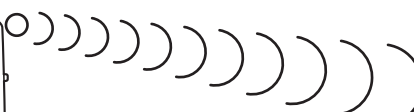



...releases the shutter on the cameras connected to the WR-R10 (transceivers).









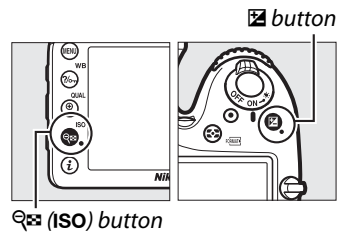







































Other Shooting Options

Two-Button Reset: Restoring Default Settings

The camera settings listed below can be restored to default values by holding the  (ISO) and  buttons down together for more than two seconds (these buttons are marked by a green dot). The control panel turns off briefly while settings are reset.



Option	Default	
Image quality	JPEG normal	66
Image size	Large	68
White balance	Auto > Normal	89
Fine tuning	A-B: 0, G-M: 0	91
HDR (high dynamic range)	Off ¹	115
ISO sensitivity settings		
ISO sensitivity		
P, S, A, M	100	79
Other shooting modes	Auto	
Auto ISO sensitivity control	Off	81
Remote control mode (ML-L3)	Off	127
Interval timer shooting	Off ²	145
Autofocus (viewfinder)		
Autofocus mode		
	AF-S	71
Modes other than 	AF-A	
AF-area mode		
   	Single-point AF	73
 	51-point dynamic-area AF	
  	Auto-area AF	

Option	Default	
Autofocus (live view/movie)		
Autofocus mode	AF-S	155
AF-area mode		
         P, S, A, M	Wide-area AF	156
 	Normal-area AF	
           	Face-priority AF	
Focus point ³	Center	75
Metering	Matrix	83
AE lock hold	Off	76, 84
Bracketing	Off	133
Picture Control settings ⁴	Unmodified	105
Flash compensation	Off	124
Exposure compensation	Off	86
Exposure delay mode	Off	241
Flash mode		
    	Auto	120
	Auto+red-eye reduction	
	Auto+slow sync	
⌈, P, S, A, M	Fill flash	
FV lock	Off	125
Multiple exposure	Off ⁵	141
Flexible program	Off	48
+ NEF (RAW)	Off	253
Special effects mode		
		
Vividness	0	180
Outlines	0	
		
Orientation	Landscape	181
Width	Normal	
		
Color	Off	182
Color range	3	

1 HDR strength is not reset.

2 If interval timer shooting is currently in progress, shooting will end. Starting time, shooting interval, and number of intervals and shots are not reset.

3 Focus point not displayed if auto-area AF is selected for AF-area mode.

4 Current Picture Control only.

5 If multiple exposure is currently in progress, shooting will end and multiple exposure will be created from exposures recorded to that point. Gain and number of shots are not reset.

Bracketing automatically varies exposure, flash level, Active D-Lighting (ADL), or white balance slightly with each shot, “bracketing” the current value. Choose in situations in which it is difficult to set exposure, flash level (i-TTL and, where supported, auto aperture flash control modes only; see pages 122, 246, and 305), white balance, or Active D-Lighting and there is not time to check results and adjust settings with each shot, or to experiment with different settings for the same subject.

■ Exposure and Flash Bracketing

To vary exposure and/or flash level over a series of photographs:

1 Select flash or exposure bracketing for Custom Setting e6 (Auto bracketing set) in the Custom Settings menu.

To display the menus, press the MENU button. Select Custom Setting e6 (Auto bracketing set) in the Custom Settings menu, highlight an option, and press OK. Choose **AE & flash** to vary both exposure and flash level, **AE only** to vary only exposure, or **Flash only** to vary only flash level.

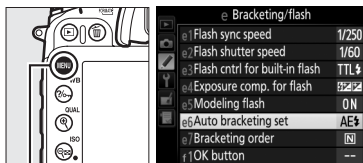

MENU button

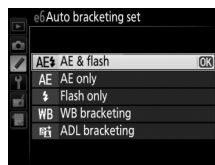

2 Choose the number of shots.

Pressing the BKT button, rotate the main command dial to choose the number of shots in the bracketing sequence and the order in which they will be taken.

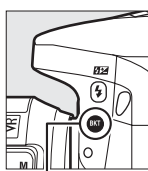

BKT button



Main command dial

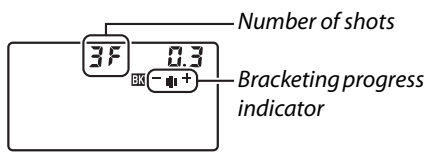

Control panel

BKT will be displayed in the viewfinder (see right); the control panel will show BKT.



3 Select a bracketing increment.

Pressing the **BKT** button and rotate the sub-command dial to choose a bracketing increment.

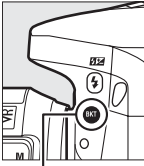

BKT button

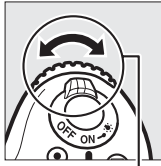

Sub-command dial

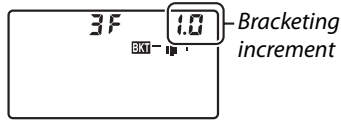

Control panel

Bracketing increment

The bracketing programs with an increment of $\frac{1}{3}$ EV are listed below:

Control panel display	No. of shots	Bracketing order (EVs)
+ 3F 0.3	3	0/+0.3/+0.7
-- 3F 0.3	3	0/-0.7/-0.3
+ 2F 0.3	2	0/+0.3
-- 2F 0.3	2	0/-0.3
3F 0.3	3	0/-0.3/+0.3
5F 0.3	5	0/-0.7/-0.3/+0.3/+0.7

See Also

For information on choosing the size of the increment, see Custom Setting b2 (**EV steps for exposure cntrl**, 234). For information on choosing the order in which bracketing is performed, see Custom Setting e7 (**Bracketing order**, 251).



4 Frame a photograph, focus, and shoot.

The camera will vary exposure and/or flash level shot-by-shot according to the bracketing program selected.

Modifications to exposure are added to those made with exposure compensation (☞ 86), making it possible to achieve exposure compensation values of more than 5 EV.



While bracketing is in effect, a bracketing progress indicator will be displayed in the control panel. A segment will disappear from the indicator after each shot.

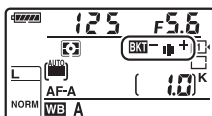

Exposure modified by:
0 EV

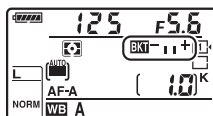

Exposure modified by:
-1 EV

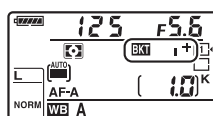

Exposure modified by:
+1 EV

To cancel bracketing, press the **BKT** button and rotate the main command dial until the bracketing progress indicator and **BKT** icon are no longer displayed.



Exposure and Flash Bracketing

In continuous low speed and continuous high speed release modes, shooting will pause after the number of shots specified in the bracketing program have been taken. Shooting will resume the next time the shutter-release button is pressed. In self-timer mode, the camera will take the number of shots selected in Step 2 on page 133 each time the shutter-release button is pressed, regardless of the option selected for Custom Setting c3 (**Self-timer**) > **Number of shots** (☐ 237); the interval between shots is however controlled by Custom Setting c3 (**Self-timer**) > **Interval between shots**. In other modes, one shot will be taken each time the shutter-release button is pressed.

If the memory card fills before all shots in the sequence have been taken, shooting can be resumed from the next shot in the sequence after the memory card has been replaced or shots have been deleted to make room on the memory card. If the camera is turned off before all shots in the sequence have been taken, bracketing will resume from the next shot in the sequence when the camera is turned on.

Exposure Bracketing

The camera modifies exposure by varying shutter speed and aperture (mode **P**), aperture (mode **S**), or shutter speed (modes **A** and **M**). If **On** is selected for **ISO sensitivity settings** > **Auto ISO sensitivity control** (☐ 81) in modes **P**, **S**, and **A**, the camera will automatically vary ISO sensitivity for optimum exposure when the limits of the camera exposure system are exceeded; in mode **M**, the camera will first use auto ISO sensitivity control to bring exposure as close as possible to the optimum and then bracket this exposure by varying shutter speed.



■ White Balance Bracketing

The camera creates multiple copies of each photograph, each with a different white balance. For more information on white balance, see page 89.

1 Select white balance bracketing.

Choose **WB bracketing** for Custom Setting e6 **Auto bracketing set**.

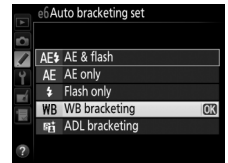

2 Choose the number of shots.

Pressing the **BKT** button, rotate the main command dial to choose the number of shots in the bracketing sequence and the order in which they will be taken.

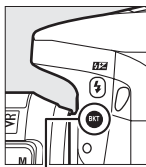

BKT button



Main command dial

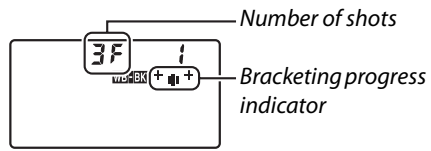

Control panel

BKT will be displayed in the viewfinder (see right); the control panel will show **WB-BKT**.



☑ White Balance Bracketing

White balance bracketing is not available at an image quality of NEF (RAW). Selecting **NEF (RAW)**, **NEF (RAW) + JPEG fine**, **NEF (RAW) + JPEG normal**, or **NEF (RAW) + JPEG basic** cancels white balance bracketing.

White balance bracketing affects only color temperature (the amber-blue axis in the white balance fine-tuning display, 91). No adjustments are made on the green-magenta axis.

In self-timer mode (59), the number of copies specified in the white-balance program will be created each time the shutter is released, regardless of the option selected for Custom Setting c3 (**Self-timer**) > **Number of shots** (237).

If the camera is turned off while the memory card access lamp is lit, the camera will power off only after all photographs in the sequence have been recorded.



3 Select a white balance increment.

Pressing the **BKT** button, rotate the sub-command dial to choose from increments of 1 (5 mired; □ 93), 2 (10 mired), or 3 (15 mired). The **B** value indicates the amount of blue, the **A** value the amount of amber (□ 91).

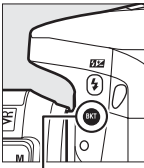

BKT button

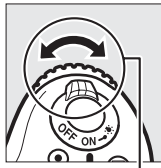

Sub-command dial

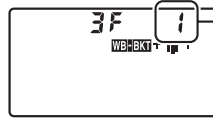

Control panel

White balance increment

The bracketing programs with an increment of 1 are listed below.

Control panel display	No. of shots	White balance increment	Bracketing order
b3F 1 +	3	1B	0 / 1 B / 2 B
R3F 1 +	3	1A	0 / 2 A / 1 A
b2F 1 +	2	1B	0 / 1 B
R2F 1 +	2	1A	0 / 1 A
3F 1 + +	3	1A, 1B	0 / 1 A / 1 B
5F 1 + +	5	1A, 1B	0 / 2 A / 1 A / 1 B / 2 B

4 Frame a photograph, focus, and shoot.

Each shot will be processed to create the number of copies specified in the bracketing program, and each copy will have a different white balance. Modifications to white balance are added to the white balance adjustment made with white balance fine-tuning.



If the number of shots in the bracketing program is greater than the number of exposures remaining, **FuLL** and the icon for the affected card will flash in the control panel, a flashing **FuL** icon will appear in the viewfinder as shown at right, and the shutter release will be disabled. Shooting can begin when a new memory card is inserted.

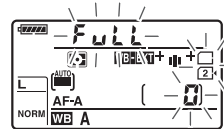

To cancel bracketing, press the **BKT** button and rotate the main command dial until the bracketing progress indicator and **WB-BKT** icon are no longer displayed.

■ ■ ADL Bracketing

The camera varies Active D-Lighting over a series of exposures. For more information on Active D-Lighting, see page 113.

1 Select ADL bracketing.

Choose **ADL bracketing** for Custom Setting e6 **Auto bracketing set**.

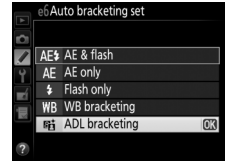

2 Choose the number of shots.

Pressing the **BKT** button, rotate the main command dial to choose the number of shots in the bracketing sequence. Choose two shots to take one photograph with Active D-Lighting off and another at the value currently selected for **Active D-Lighting** in the shooting menu (if Active D-Lighting is off, the second shot will be taken with Active D-Lighting set to **Auto**). Choose three shots to take a series of photographs with Active D-Lighting set to **Off**, **Normal**, and **High**.

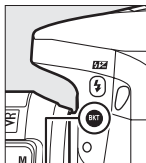

BKT button



Main command dial

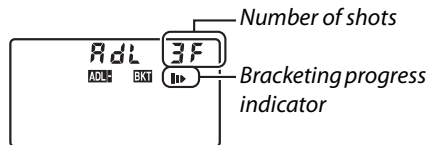





Control panel

BKT will be displayed in the viewfinder (see right); the control panel will show **ADL=BKT**.



3 Frame a photograph, focus, and shoot.

The camera will vary Active D-Lighting shot-by-shot according to the bracketing program selected. While bracketing is in effect, a bracketing progress indicator will be displayed in the control panel. A segment will disappear from the indicator after each shot: if the bracketing program contains two shots, the indicator will change from  to , while if the program contains three shots the indicator will change from  to  to .

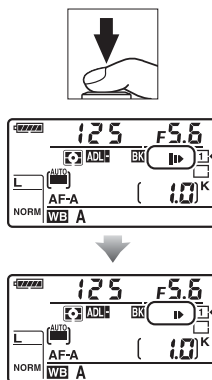

To cancel bracketing, press the **BKT** button and rotate the main command dial until the bracketing progress indicator and **ADL-BKT** icon are no longer displayed.



ADL Bracketing

In continuous low speed and continuous high speed release modes, shooting will pause after the number of shots specified in the bracketing program have been taken. Shooting will resume the next time the shutter-release button is pressed. In self-timer mode, the camera will take the number of shots selected in Step 2 on page 139 each time the shutter-release button is pressed, regardless of the option selected for Custom Setting c3 (**Self-timer**) > **Number of shots** (☐ 237); the interval between shots is however controlled by Custom Setting c3 (**Self-timer**) > **Interval between shots**. In other modes, one shot will be taken each time the shutter-release button is pressed.

If the memory card fills before all shots in the sequence have been taken, shooting can be resumed from the next shot in the sequence after the memory card has been replaced or shots have been deleted to make room on the memory card. If the camera is turned off before all shots in the sequence have been taken, bracketing will resume from the next shot in the sequence when the camera is turned on.

Multiple Exposure

(P, S, A, and M Modes Only)

Follow the steps below to record a series of two or three exposures in a single photograph. Multiple exposures produce colors noticeably superior to those in software-generated photographic overlays created from existing images.

■ Creating a Multiple Exposure

Multiple exposures can not be recorded in live view. Exit live view before proceeding.

Extended Recording Times

For an interval between exposures of more than 30 s, extend the meter-off delay using Custom Setting c2 (**Standby timer**,  237). The maximum interval between exposures is 30 s longer than the option selected for Custom Setting c2. Shooting will end automatically if no operations are performed for a set period and a multiple exposure will be created from the exposures that have been recorded to that point.

1 Select Multiple exposure in the shooting menu.

Press the **MENU** button to display the menus.

Highlight **Multiple exposure** in the shooting menu and press **▶**.

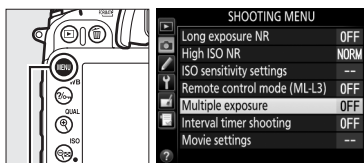

MENU button



2 Select a mode.

Highlight **Multiple exposure mode** and press ►.

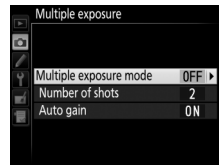

Highlight one of the following and press **OK**.

- To take a series of multiple exposures, select **ON** **On (series)**. Multiple exposure shooting will continue until you select **Off** for **Multiple exposure mode**.
- To take one multiple exposure, select **On (single photo)**. Normal shooting will resume automatically after you have created a single multiple exposure.
- To exit without creating additional multiple exposures, select **Off**.

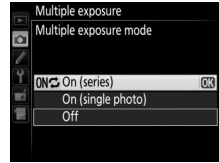

If **On (series)** or **On (single photo)** is selected, a  icon will be displayed in the control panel.

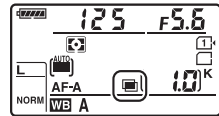

3 Choose the number of shots.

Highlight **Number of shots** and press ►.

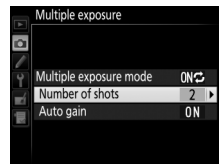

Press ▲ or ▼ to choose the number of exposures that will be combined to form a single photograph and press **OK**.



4 Choose the amount of gain.

Highlight **Auto gain** and press ►.

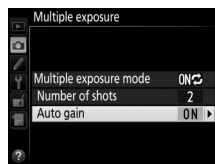

The following options will be displayed.
Highlight an option and press **OK**.

- **On**: Gain is adjusted according to number of exposures actually recorded (gain for each exposure is set to $1/2$ for 2 exposures, $1/3$ for 3 exposures, etc.).
- **Off**: Gain is not adjusted when recording multiple exposure. Recommended if background is dark.

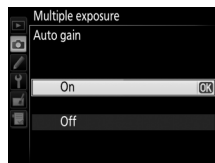

5 Frame a photograph, focus, and shoot.

In continuous high-speed and continuous low-speed release modes (☐ 57), the camera records all exposures in a single burst. If **On (series)** is selected, the camera will continue to record multiple exposures while the shutter-release button is pressed; if **On (single photo)** is selected, multiple exposure shooting will end after the first photograph. In self-timer mode, the camera will automatically record the number of exposures selected in Step 3 on page 142, regardless of the option selected for Custom Setting c3 (**Self-timer**) > **Number of shots** (☐ 237); the interval between shots is however controlled by Custom Setting c3 (**Self-timer**) > **Interval between shots**. In other release modes, one photograph will be taken each time the shutter-release button is pressed; continue shooting until all exposures have been recorded (for information on interrupting a multiple exposure before all photographs are recorded, see page 144).



The  icon will flash until shooting ends. If **On (series)** is selected, multiple exposure shooting will only end when **Off** is selected for multiple exposure mode; if **On (single photo)** is selected, multiple exposure shooting ends automatically when the multiple exposure is complete.

The  icon clears from the display when multiple exposure shooting ends.

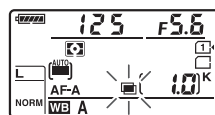

■ Interrupting Multiple Exposures

To interrupt a multiple exposure before the specified number of exposures have been taken, select **Off** for multiple exposure mode. If shooting ends before the specified number of exposures have been taken, a multiple exposure will be created from the exposures that have been recorded to that point. If

Auto gain is on, gain will be adjusted to reflect the number of exposures actually recorded. Note that shooting will end automatically if:

- A two-button reset is performed (☰ 131)
- The camera is turned off
- The battery is exhausted
- Pictures are deleted

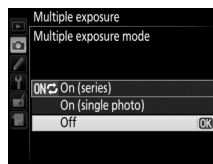

✓ Multiple Exposures

Do not remove or replace the memory card while recording a multiple exposure.

Multiple exposures can not be recorded in live view. Taking photographs in live view resets **Multiple exposure mode** to **Off**.

Noise (randomly-spaced bright pixels, fog, or lines) may appear in photographs taken with **Off** selected for auto gain (☰ 143).

The information listed in the playback photo information display (including metering, exposure, shooting mode, focal length, date of recording and camera orientation) is for the first shot in the multiple exposure.

✍ Interval Timer Photography

If interval timer photography is activated before the first exposure is taken, the camera will record exposures at the selected interval until the number of exposures specified in the multiple exposure menu have been taken (the number of shots listed in the interval timer shooting menu is ignored). These exposures will then be recorded as a single photograph and interval timer shooting will end (if **On (single photo)** is selected for multiple exposure mode, multiple exposure shooting will also end automatically).

✍ Other Settings

While a multiple exposure is being shot, memory cards can not be formatted and some menu items are grayed out and can not be changed.

Interval Timer Photography

The camera is equipped to take photographs automatically at preset intervals.

☑ Before Shooting

Do not select self-timer (⌚) or **MUP** release mode when using the interval timer. Before beginning interval timer photography, take a test shot at current settings and view the results in the monitor.

Before choosing a starting time, select **Time zone and date** in the setup menu and make sure that the camera clock is set to the correct time and date (📅 265).

Use of a tripod is recommended. Mount the camera on a tripod before shooting begins. To ensure that shooting is not interrupted, be sure the camera EN-EL15 battery is fully charged. If in doubt, charge the battery before use or use an EH-5b AC adapter and EP-5B power connector (available separately).

1 Select Interval timer shooting in the shooting menu.

Press the **MENU** button to display the menus. Highlight **Interval timer shooting** in the shooting menu and press ►.



MENU button

2 Choose a starting time.

Choose from the following starting triggers.

- **To start shooting immediately**, highlight **Now** and press ►. Shooting begins about 3 s after settings are completed; proceed to Step 3.
- **To choose a starting time**, highlight **Start time** and press ► to display the start time options shown at right. Press ◀ or ► to highlight hours or minutes and press ▲ or ▼ to change. Press ► to continue.

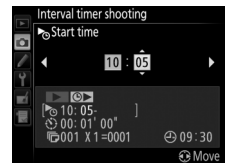
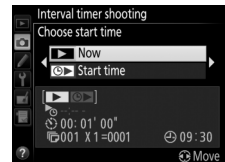

3 Choose the interval.

Press ◀ or ► to highlight hours, minutes, or seconds; press ▲ or ▼ to change. Choose an interval longer than the time needed to take the number of shots selected in Step 4. If the interval is too short, the number of photos taken may be less than the total listed in Step 4 (the number of intervals multiplied by the number of shots per interval). Press ► to continue.



4 Choose the number of intervals and number of shots per interval.

Press ◀ or ▶ to highlight number of intervals or number of shots; press ▲ or ▼ to change. Press ▶ to continue.

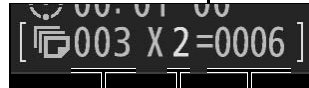

Number of intervals Number of shots/ interval Total number of shots

5 Start shooting.

Highlight **On** and press **OK** (to return to the shooting menu without starting the interval timer, highlight **Off** and press **OK**). The first series of shots will be taken at the specified starting time, or after about 3 s if **Now** was selected for **Choose start time** in Step 2. Shooting will continue at the selected interval until all shots have been taken. Note that because the shutter speed, frame rate, and time needed to record images may vary from one interval to the next, the time between the end of one interval and the beginning of the next may vary. If shooting can not proceed at current settings (for example, if a shutter speed of Bulb (b u l b) or Time (- -) is currently selected in shooting mode **M** or the start time is in less than a minute), a warning will be displayed in the monitor.

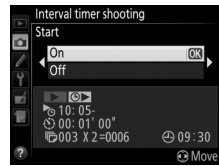

Out of Memory

If the memory card is full, the interval timer will remain active but no pictures will be taken. Resume shooting (148) after deleting some pictures or turning the camera off and inserting another memory card.

Cover the Viewfinder

To prevent light entering via the viewfinder interfering with exposure, remove the rubber eyecup and cover the viewfinder with the supplied DK-5 eyepiece cap (60).

Interval Timer Photography

Interval timer photography can not be combined with remote control photography using the optional ML-L3 remote control (□ 127), live view photography (□ 153), or movie live view (□ 161).

Release Mode

Regardless of the release mode selected, the camera will take the specified number of shots at each interval. In continuous modes, photographs will be taken at a rate given on page 58. In **S** (single frame) mode, photographs will be taken at the rate chosen for Custom Setting d5 (**CL mode shooting speed**, □ 239); in mode **Q**, camera noise will be reduced.

Bracketing

Adjust bracketing settings before starting interval timer photography. If exposure, flash, or ADL bracketing is active while interval timer photography is in effect, the camera will take the number of shots in the bracketing program at each interval, regardless of the number of shots specified in the interval timer menu. If white balance bracketing is active while interval timer photography is in effect, the camera will take one shot at each interval and process it to create the number of copies specified in the bracketing program.

During Shooting

During interval timer photography, the **INTVL** icon in the control panel will flash. Immediately before the next shooting interval begins, the shutter speed display will show the number of intervals remaining, and the aperture display will show the number of shots remaining in the current interval. At other times, the number of intervals remaining and the number of shots in each interval can be viewed by pressing the shutter-release button halfway (once the button is released, the shutter speed and aperture will be displayed until the standby timer expires).

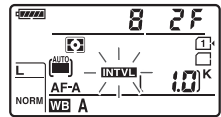

To view current interval timer settings, select **Interval timer shooting** between shots. While interval timer photography is in progress, the interval timer menu will show the starting time, the shooting interval, and the number of intervals and shots remaining. None of these items can be changed while interval timer photography is in progress.

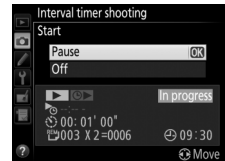

Pictures can be played back and shooting and menu settings can be adjusted freely while interval timer photography is in progress. The monitor will turn off automatically about four seconds before each interval.



■ Pausing Interval Timer Photography

Interval timer photography can be paused by:

- Pressing the **OK** button between intervals
- Highlighting **Start > Pause** in the interval timer menu and pressing **OK**
- Turning the camera off and then on again (if desired, the memory card can be replaced while the camera is off)
- Selecting self-timer (☺) or **MUP** release mode

To resume shooting:

1 Choose a new starting time.

Choose a new starting time as described on page 145.

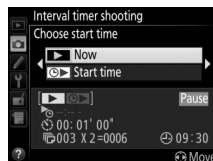

2 Resume shooting.

Highlight **Restart** and press **OK**. Note that if interval timer photography was paused during shooting, any shots remaining in the current interval will be canceled.

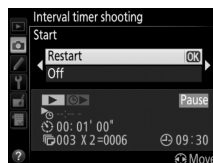

■ Interrupting Interval Timer Photography

Interval timer shooting will end automatically if the battery is exhausted. Interval timer photography can also be ended by:

- Selecting **Start > Off** in the interval timer menu
- Performing a two button reset (□ 131)
- Selecting **Reset shooting menu** in the shooting menu (□ 224)
- Changing bracketing settings (□ 133)
- Terminating HDR (□ 115) or multiple exposure shooting (□ 144)

Normal shooting will resume when interval timer photography ends.

■ No Photograph

The camera will skip the current interval if any of the following situations persist for eight seconds or more after the interval was due to start: the photograph or photographs for the previous interval have yet to be taken, the memory buffer is full, or the camera is unable to focus in **AF-S** or when single-servo AF is selected in **AF-A** (note that the camera focuses again before each shot). Shooting will resume with the next interval.

Non-CPU Lenses

By specifying lens data (lens focal length and maximum aperture), the user can gain access to a variety of CPU lens functions when using a non-CPU lens.

If the focal length of the lens is known:

- Power zoom can be used with optional SB-910, SB-900, SB-800, SB-700, and SB-600 flash units
- Lens focal length is listed (with an asterisk) in the playback photo info display

If the maximum aperture of the lens is known:

- The aperture value is displayed in the control panel and viewfinder
- Flash level is adjusted for changes in aperture if the flash unit supports AA (auto aperture) mode
- Aperture is listed (with an asterisk) in the playback photo info display

Specifying both the focal length and maximum aperture of the lens:

- Enables color matrix metering (note that it may be necessary to use center-weighted or spot metering to achieve accurate results with some lenses, including Reflex-NIKKOR lenses)
- Improves the precision of center-weighted and spot metering and i-TTL balanced fill-flash for digital SLR



The camera can store data for up to nine non-CPU lenses. To enter or edit data for a non-CPU lens:

1 Select Non-CPU lens data.

Press the **MENU** button to display the menus. Highlight **Non-CPU lens data** in the setup menu and press **▶**.

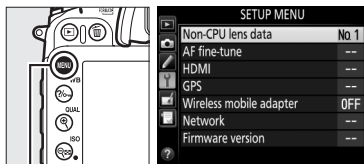

MENU button

2 Choose a lens number.

Highlight **Lens number** and press **◀** or **▶** to choose a lens number between 1 and 9.

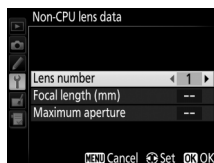

3 Enter the focal length and aperture.

Highlight **Focal length (mm)** or **Maximum aperture** and press **◀** or **▶** to edit the highlighted item. Focal length can be selected from values between 6 and 4000 mm, maximum aperture from values between f/1.2 and f/22.

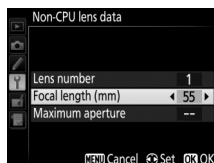

Focal Length Not Listed

If the correct focal length is not listed, choose the closest value greater than the actual focal length of the lens.

Teleconverters and Zoom Lenses

The maximum aperture for teleconverters is the combined maximum aperture of the teleconverter and the lens. Note that lens data are not adjusted when non-CPU lenses are zoomed in or out. The data for different focal lengths can be entered as separate lens numbers, or the data for the lens can be edited to reflect the new values for lens focal length and maximum aperture each time zoom is adjusted.

4 Save settings and exit.

Press **OK**. The specified focal length and aperture will be stored under the chosen lens number.



To recall lens data when using a non-CPU lens:

1 Assign non-CPU lens number selection to a camera control.

Select **Choose non-CPU lens number** as the “Press + command dials” option for a camera control in the Custom Settings menu. Non-CPU lens number selection can be assigned to the **Fn** button (Custom Setting f2, **Assign Fn button**, □ 253), the depth-of-field preview button (Custom Setting f3, **Assign preview button**, □ 255), or the ^{AE-L}/_{AF-L} **AE-L/AF-L** button (Custom Setting f4, **Assign AE-L/AF-L button**, □ 256).

2 Use the selected control to choose the lens number.

Press the selected button and rotate the main command dial until the desired lens number is displayed in the control panel.

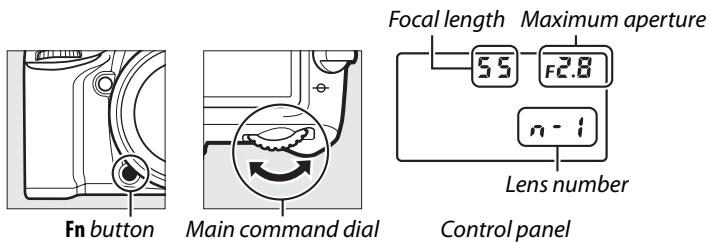

Using a GPS Unit

An optional GP-1 GPS unit can be connected to the camera's accessory terminal (□ 310) using the cable supplied with the GPS unit, allowing information on the camera's current position to be recorded when photographs are taken. Turn the camera off before connecting the GPS unit; for more information, see the manual provided with the GPS Unit.

■ Setup Menu Options

The **GPS** item in the setup menu contains the options listed below.

- **Standby timer:** Choose whether the exposure meters turn off automatically when a GPS unit is attached.

Option	Description
Enable	Exposure meters turn off automatically if no operations are performed for the time selected for Custom Setting c2 (Standby timer , □ 237; to allow the camera time to acquire GPS data, the delay is extended by up to one minute after the exposure meters are activated or the camera is turned on). This reduces the drain on the battery.
Disable	Exposure meters do not turn off while a GPS unit is connected.

- **Position:** This item is only available if a GPS unit is connected, when it displays the current latitude, longitude, altitude, and Coordinated Universal Time (UTC) as reported by GPS.
- **Use GPS to set camera clock:** Select **Yes** to synchronize the camera clock with the time reported by the GPS device.

☑ Coordinated Universal Time (UTC)

UTC data is provided by the GPS device and is independent of the camera clock.

☑ The GPS Icon

Connection status is shown by the GPS icon:

- **GPS (static):** Camera has established communication with the GPS unit. Photo information for pictures taken while this icon is displayed include an additional page of GPS data (□ 191).
- **GPS (flashing):** The GPS unit is searching for a signal. Pictures taken while the icon is flashing do not include GPS data.
- **No icon:** No new GPS data have been received from the GPS unit for at least two seconds. Pictures taken when the GPS icon is not displayed do not include GPS data.

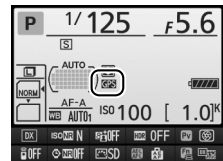



Live View Photography

Follow the steps below to take photographs in live view.

1 Rotate the live view selector to (live view photography).

Cover the Viewfinder

To prevent light entering via the viewfinder from interfering with exposure, remove the rubber eyecup and cover the viewfinder with the supplied DK-5 eyepiece cap before shooting ( 60).

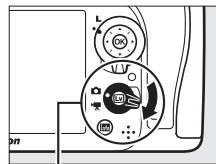

Live view selector

2 Press the button.

The mirror will be raised and the view through the lens will be displayed in the camera monitor. The subject will no longer be visible in the viewfinder.

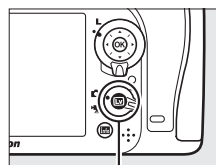

 button



3 Position the focus point.

Position the focus point over your subject as described on page 155.

4 Focus.

Press the shutter-release button halfway to focus.



The focus point will flash green while the camera focuses. If the camera is able to focus, the focus point will be displayed in green; if the camera is unable to focus, the focus point will flash red (note that pictures can be taken even when the focus point flashes red; check focus in the monitor before shooting). Exposure can be locked by pressing the  **AE-L/AF-L** button ( 84); focus locks while the shutter-release button is pressed halfway. In mode **M**, exposure can be adjusted with the assistance of an exposure indicator ( 51).

 **AE-L/AF-L** button

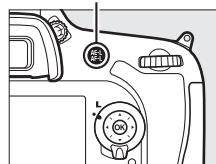

5 Take the picture.

Press the shutter-release button the rest of the way down to shoot. The monitor will turn off.



6 Exit live view mode.

Press the  button to exit live view mode.

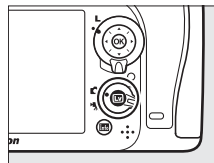

Ending Live View

Live view ends automatically if the lens is removed. Live view may also end automatically to prevent damage to the camera's internal circuits; exit live view when the camera is not in use. Note that the temperature of the camera's internal circuits may rise and noise (bright spots, randomly-spaced bright pixels, or fog) may be displayed in the following instances (the camera may also become noticeably warm, but this does not indicate a malfunction):

- The ambient temperature is high
- The camera has been used for extended periods in live view or to record movies
- The camera has been used in continuous release mode for extended periods

If live view does not start when you attempt to start live view, wait for the internal circuits to cool and then try again.

Movies

Movie recording is not available during live view photography and pressing the movie-record button has no effect. Select movie live view ( 161) to shoot movies.



Focusing in Live View

To focus using autofocus, rotate the focus-mode selector to **AF** and follow the steps below to choose autofocus and AF-area modes. For information on focusing manually, see page 159.

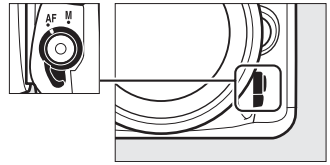
Focus-mode selector



■ Choosing a Focus Mode

The following autofocus modes are available in live view (note that full-time-servo AF is not available in  and  modes):

Mode	Description
AF-S	Single-servo AF: For stationary subjects. Focus locks when shutter-release button is pressed halfway.
AF-F	Full-time-servo AF: For moving subjects. Camera focuses continuously until shutter-release button is pressed. Focus locks when shutter-release button is pressed halfway.

To choose an autofocus mode, press the AF-mode button and rotate the main command dial until the desired mode is displayed in the monitor.

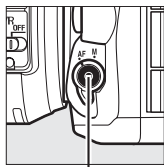

AF-mode button



Main command dial

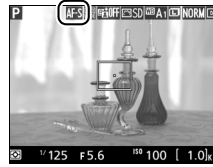



Monitor









Using Autofocus in Live View

Use an AF-S lens. The desired results may not be achieved with other lenses or teleconverters. Note that in live view, autofocus is slower and the monitor may brighten or darken while the camera focuses. The focus point may sometimes be displayed in green when the camera is unable to focus. The camera may be unable to focus in the following situations:

- The subject contains lines parallel to the long edge of the frame
- The subject lacks contrast
- The subject in the focus point contains areas of sharply contrasting brightness, or includes spot lighting or a neon sign or other light source that changes in brightness
- Flicker or banding appears under fluorescent, mercury-vapor, sodium-vapor, or similar lighting
- A cross (star) filter or other special filter is used
- The subject appears smaller than the focus point
- The subject is dominated by regular geometric patterns (e.g., blinds or a row of windows in a skyscraper)
- The subject is moving

■ ■ Choosing an AF-Area Mode

In modes other than , the following AF-area modes can be selected in live view (note that subject-tracking AF is not available in , , and  modes):

Mode	Description
	Face-priority AF: Use for portraits. The camera automatically detects and focuses on portrait subjects; the selected subject is indicated by a double yellow border (if multiple faces, up to a maximum of 35, are detected, the camera will focus on the closest subject; to choose a different subject, use the multi selector). If the camera can no longer detect the subject (because, for example, the subject has turned to face away from the camera), the border will no longer be displayed.
	Wide-area AF: Use for hand-held shots of landscapes and other non-portrait subjects. Use the multi selector to move the focus point anywhere in the frame, or press  to position the focus point in the center of the frame.
	Normal-area AF: Use for pin-point focus on a selected spot in the frame. Use the multi selector to move the focus point anywhere in the frame, or press  to position the focus point in the center of the frame. A tripod is recommended.
	Subject-tracking AF: Position the focus point over your subject and press  . The focus point will track the selected subject as it moves through the frame. To end tracking, press  again. Note that the camera may be unable to track subjects if they move quickly, leave the frame or are obscured by other objects, change visibly in size, color, or brightness, or are too small, too large, too bright, too dark, or similar in color or brightness to the background.

To choose an AF-area mode, press the AF-mode button and rotate the sub-command dial until the desired mode is displayed in the monitor.

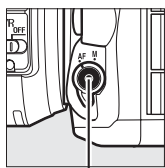

AF-mode button

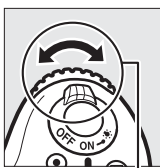

Sub-command dial



Monitor

Using the *i* Button

The options listed below can be accessed by pressing the *i* button during live view photography. Highlight items using the multi-selector and press ► to view options for the highlighted item. After choosing the desired setting, press OK to exit.



i button

Option	Description	
Image area	Choose from the DX (24×16) and 1.3× (18×12) image areas (☰ 63).	
Image quality	Choose image quality (☰ 66).	
Image size	Choose image size (☰ 68).	
Set Picture Control	Choose a Picture Control (☰ 105).	
Active D-Lighting	Adjust Active D-Lighting to preserve details in highlights and shadows (☰ 113).	
Remote control mode (ML-L3)	Choose from Delayed remote , Quick-response remote , and Remote mirror-up modes for remote control photography using the optional ML-L3 remote control (☰ 127).	
Monitor brightness	Press ▲ or ▼ to adjust monitor brightness for live view. Changes to monitor brightness have no effect on photographs recorded with the camera.	



The Live View Display: Live View Photography

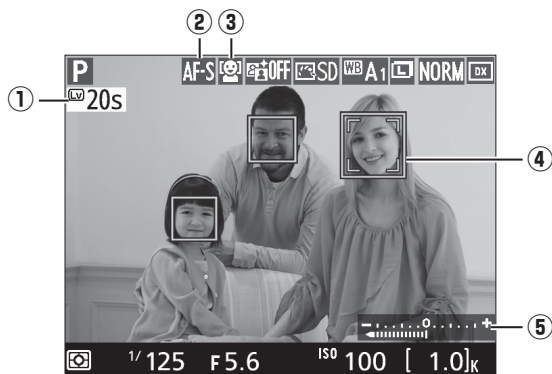

Item	Description	
① Time remaining	The amount of time remaining before live view ends automatically. Displayed if shooting will end in 30 s or less.	160
② Autofocus mode	The current autofocus mode.	155
③ AF-area mode	The current AF-area mode.	156
④ Focus point	The current focus point. The display varies with the option selected for AF-area mode.	153
⑤ Exposure indicator	Indicates whether the photograph would be under- or overexposed at current settings (mode M only).	51

Note: Display shown with all indicators lit for illustrative purposes.

LV

Exposure

Depending on the scene, exposure may differ from that which would be obtained when live view is not used. Metering in live view is adjusted to suit the live view display, producing photographs with exposure close to what is seen in the monitor. In **P**, **S**, **A**, **M**, and **LV** modes, exposure can be adjusted by ± 5 EV (86). Note that the effects of values over $+3$ EV or under -3 EV can not be previewed in the monitor.

See Also

See page 98 for information on measuring a value for preset white balance during live view.

The Information Display: Live View Photography

To hide or display indicators in the monitor during live view photography, press the **info** button.

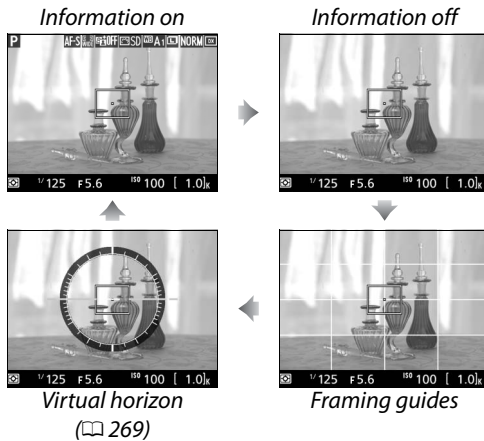

Manual Focus

To focus in manual focus mode (**info** 78), rotate the lens focus ring until the subject is in focus.

To magnify the view in the monitor up to about 19× for precise focus, press the **QUAL** button. While the view through the lens is zoomed in, a navigation window will appear in a gray frame at the bottom right corner of the display. Use the multi selector to scroll to areas of the frame not visible in the monitor (available only if wide- or normal-area AF is selected for AF-area mode), or press **ISO** to zoom out.

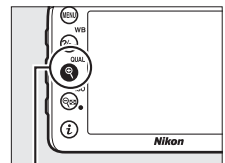
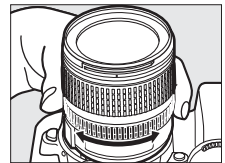

QUAL button



Navigation window



Non-CPU Lenses

When using non-CPU lenses, be sure to enter the focal length and maximum aperture using the **Non-CPU lens data** option in the setup menu (□ 149). Non-CPU lenses can be used only in **A** and **M** modes (□ 47); aperture can be adjusted using the lens aperture ring.

The Live View Display

Although they will not appear in the final picture, jagged edges, color fringing, moire, and bright spots may appear in the monitor, while bright bands may appear in some areas with flashing signs and other intermittent light sources or if the subject is briefly illuminated by a flash or other bright, momentary light source. In addition, distortion may occur if the camera is panned horizontally or an object moves at high speed through the frame. Flicker and banding visible in the monitor under fluorescent, mercury vapor, or sodium lamps can be reduced using **Flicker reduction** (□ 264), although they may still be visible in the final photograph at some shutter speeds. When shooting in live view mode, avoid pointing the camera at the sun or other strong light sources. Failure to observe this precaution could result in damage to the camera's internal circuitry.

The Count Down Display

A count down will be displayed 30 s before live view ends automatically (□ 158; the timer turns red if live view is about to end to protect the internal circuits or, if an option other than **No limit** is selected for Custom Setting c4—**Monitor off delay > Live view**; □ 238—5 s before the monitor is due to turn off automatically). Depending on shooting conditions, the timer may appear immediately when live view is selected. Note that although the count down does not appear during playback, live view will still end automatically when the timer expires.

HDMI

If the camera is attached to an HDMI video device during live view photography, the camera monitor will remain on and the video device will display the view through the lens. If the device supports HDMI-CEC, select **Off** for the **HDMI > Device control** option in the setup menu (□ 216) before shooting in live view.



Movie Live View

Movies can be recorded in live view.

1 Rotate the live view selector to (movie live view).

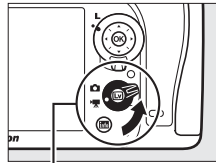

Live view selector

2 Press the button.

The mirror will be raised and the view through the lens will be displayed in the camera monitor as it would appear in the actual movie, modified for the effects of exposure. The subject will no longer be visible in the viewfinder.

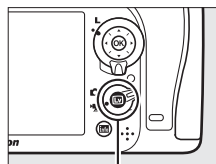

 button

The Icon

A  icon ([□ 165](#)) indicates that movies can not be recorded.

Before Recording

Before recording, choose an aperture (modes **A** and **M** only, [□ 50, 51](#)) and, if desired, a color space ([□ 227](#)).

3 Choose a focus mode ([□ 155](#)).



4 Choose an AF-area mode ([□ 156](#)).



5 Focus.

Frame the opening shot and focus as described in Steps 3 and 4 on pages 153 (for more information on focusing in movie live view, see page 155). Note that the number of subjects that can be detected in face-priority AF drops in movie live view.







Exposure

The following settings can be adjusted in movie live view:

	Aperture	Shutter speed	ISO sensitivity	Exposure compensation
P, S, A, 	—	—	—	✓
M	—	✓	✓	—
Other shooting modes	—	—	—	—

In mode **M**, ISO sensitivity can be set to values between 100 and Hi 2 and shutter speed to values between $\frac{1}{25}$ s and $\frac{1}{8000}$ s (the slowest available shutter speed varies with the frame rate;  169). In other modes, shutter speed and ISO sensitivity are adjusted automatically. If the result is over- or under-exposed, exit and restart movie live view.

6 Start recording.

Press the movie-record button to start recording. A recording indicator and the time available are displayed in the monitor. Exposure is set using matrix metering and can be locked by pressing the  **AE-L/AF-L** button ( 84) or (in modes **P**, **S**, **A**, and ) altered by up to ± 3 EV in steps of $\frac{1}{3}$ EV by pressing the  button and rotating the main command dial ( 86). In autofocus mode, focus can be locked by pressing the shutter-release button halfway.

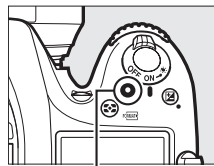

Movie-record button
Recording indicator



Time remaining

7 End recording.

Press the movie-record button again to end recording. Recording will end automatically when the maximum length is reached, or the memory card is full.

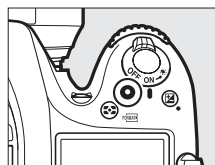

Maximum Length

The maximum length for individual movie files is 4 GB (for maximum recording times, see page 169); note that depending on memory card write speed, shooting may end before this length is reached (□ 347).

Taking Photographs

To take a photograph while recording is in progress, press the shutter-release button all the way down (if desired, shooting information display can be assigned to the **Fn**, depth-of-field preview, or **AE-L/AF-L** button and the button used to display camera still photography settings before shooting; □ 259, 260). Movie recording will end (the footage recorded to that point will be saved) and the camera will return to live view. The photograph will be recorded at the current image area setting using a crop with an aspect ratio of 16 : 9. Photos will be taken with the flash off. Note that the exposure for photographs can not be previewed during movie live view; mode **P**, **S**, or **A** is recommended, but accurate results can be achieved in mode **M** by using the **Fn**, depth-of-field preview, or **AE-L/AF-L** button (□ 259, 260) to display shooting information and checking the exposure indicator. Exposure compensation for the photograph can be set to values between -5 and +5 EV, but only values between -3 and +3 can be previewed in the monitor (modes **P**, **S**, **A**, and **M**; □ 86).

The Count-Down Display

A count down will be displayed 30 s before live view ends automatically (□ 158). Depending on shooting conditions, the timer may appear immediately when movie recording begins. Note that regardless of the amount of recording time available, live view will still end automatically when the timer expires. Wait for the internal circuits to cool before resuming movie recording.

8 Exit live view mode.

Press the  button to exit live view mode.

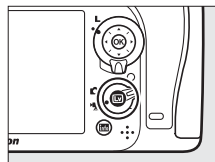

Using the *i* Button

The options listed below can be accessed by pressing the *i* button before recording begins in movie live view (pressing the *i* button while recording is in progress has no effect). Highlight items using the multi selector and press **▶** to view options for the highlighted item. After choosing the desired setting, press **⊕** to exit.

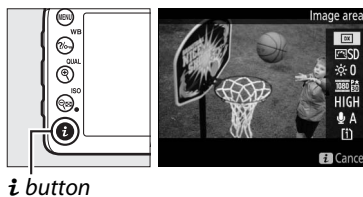

Option	Description
Image area	Choose from the DX (24×16) and 1.3× (18×12) image areas (☞ 63).
Set Picture Control	Choose a Picture Control (☞ 105).
Monitor brightness	Press ▲ or ▼ to adjust monitor brightness for movie live view. Changes to monitor brightness have no effect on movies recorded with the camera.
Frame size/frame rate	Select a frame size and rate (☞ 169).
Movie quality	Choose movie quality (☞ 169).
Microphone	Press ▲ or ▼ to adjust microphone sensitivity (☞ 169). Both the built-in microphone and optional ME-1 stereo microphones are affected.
Destination	When two memory cards are inserted, you can choose the card to which movies are recorded (☞ 169).
Headphone volume	Displayed only when third-party headphones are plugged into the headphone connector. Press ▲ or ▼ to adjust headphone volume (☞ 165).

The Live View Display: Movie Live View

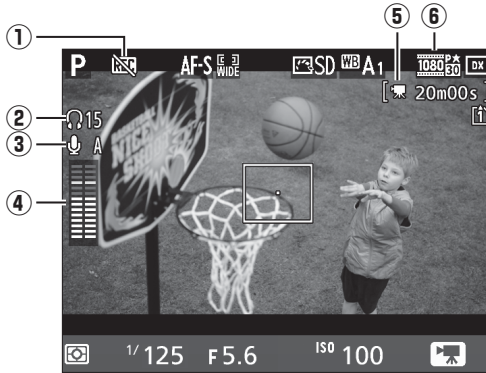

Item	Description	
① "No movie" icon	Indicates that movies can not be recorded.	—
② Headphone volume	Volume of audio output to headphones.	164
③ Microphone sensitivity	Microphone sensitivity for movie recording.	164
④ Sound level	Sound level for audio recording. Displayed in red if level is too high; adjust microphone sensitivity accordingly.	164, 169
⑤ Time remaining (movie live view)	The recording time available for movies.	162
⑥ Movie frame size	The frame size for movie recording.	169

Using an External Microphone

The optional ME-1 stereo microphone can be used to reduce noise caused by lens vibration being recorded during autofocus.

Headphones

Third-party headphones can be used. Note that high sound levels may result in high volume; particular care should be taken when headphones are used.



The Information Display: Movie Live View

To hide or display indicators in the monitor during movie live view, press the **Info** button.

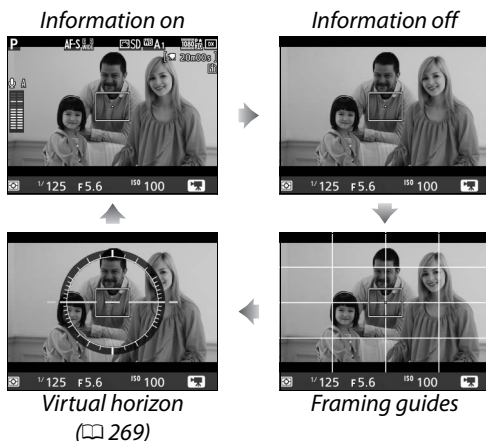

See Also

Frame size, microphone sensitivity, and card slot options are also available in the **Movie settings** menu (□ 169). Focus can be adjusted manually as described on page 159. The roles played by the **OK**, **Fn**, depth-of-field preview, and **AE-L/AF-L** buttons can be chosen using Custom Settings f1 (**OK button**; □ 252), g1 (**Assign Fn button**; □ 259), g2 (**Assign preview button**; □ 260), and g3 (**Assign AE-L/AF-L button**, □ 260), respectively (the last three options also allow you to lock exposure without having to keep a button pressed). Custom Setting g4 (**Assign shutter button**; □ 260) controls whether the shutter-release button can be used to start movie live view or to start and end movie recording.

Image Area

Regardless of the option selected for **Image area** in the shooting menu (☐ 63), all movies and photographs recorded in movie live view (☐ 161) have an aspect ratio of 16 : 9. Selecting **1.3× (18×12)**, however, reduces the angle of view and increases the apparent focal length of the lens. A  icon is displayed when **1.3× (18×12)** is selected.

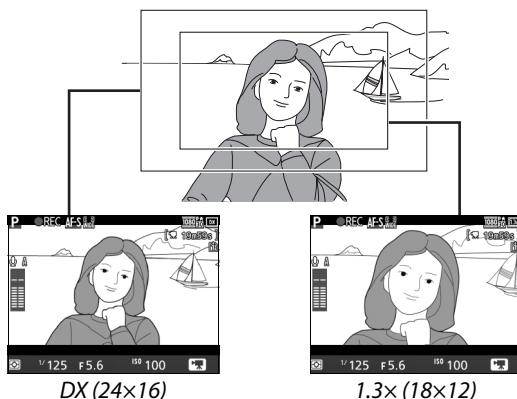

DX (24×16)

1.3× (18×12)

Movie Live View Photographs

The following table shows the size of photographs taken in movie live view:

Image area	Size/image quality option	Size (pixels)	Print size (cm/in.)*
DX (24×16)	Large	6000 × 3368	50.8 × 28.5/20.0 × 11.2
	Medium	4496 × 2528	38.1 × 21.4/15.0 × 8.4
	Small	2992 × 1680	25.3 × 14.2/10.0 × 5.6
1.3× (18×12)	Large	4800 × 2696	40.6 × 22.8/16.0 × 9.0
	Medium	3600 × 2024	30.5 × 17.1/12.0 × 6.7
	Small	2400 × 1344	20.3 × 11.4/ 8.0 × 4.5

* Approximate size when printed at 300 dpi. Print size in inches equals image size in pixels divided by printer resolution in dots per inch (dpi; 1 inch = approximately 2.54 cm).

Image quality is determined by the option selected for **Image quality** in the shooting menu (☐ 66).

HDMI

If the camera is connected to an HDMI device (☐ 215), the view through the lens will appear both in the camera monitor and on the HDMI device. Indicators in the monitor and on the HDMI device can be hidden or displayed using the  button. To use live view when the camera is connected to an HDMI-CEC device, select **Off** for **HDMI > Device control** in the setup menu (☐ 216). If **1920×1080; 60i**, **1920×1080; 50i**, **1280× 720; 60p**, or **1280×720; 50p** is selected for **Frame size/frame rate**, the monitor will turn off when the camera is connected to an HDMI video device.

Remote Movie Recording

If **Record movies** is selected for Custom Setting g4 (**Assign shutter button**, ☐ 260), the shutter-release buttons on optional remote cords or optional wireless remote controllers (☐ 309, 310) can be used to start movie live view and to start and end movie recording.

Recording Movies

Flicker, banding, or distortion may be visible in the monitor and in the final movie under fluorescent, mercury vapor, or sodium lamps or if the camera is panned horizontally or an object moves at high speed through frame (for information on reducing flicker and banding, see **Flicker reduction**, ☐ 264). Jagged edges, color fringing, moiré, and bright spots may also appear. Bright bands may appear in some areas of the frame with flashing signs and other intermittent light sources or if the subject is briefly illuminated by a flash or other bright, momentary light source. When recording movies, avoid pointing the camera at the sun or other strong light sources. Failure to observe this precaution could result in damage to the camera's internal circuitry. Note that noise (randomly-spaced bright pixels, fog, or lines) and unexpected colors may appear if you zoom in on the view through the lens (☐ 159) during movie live view.

The camera can record both video and sound; do not cover the microphone during recording. Note that the built-in microphone may record lens noise during autofocus and vibration reduction.

Flash lighting can not be used during movie live view.

Recording ends automatically if the lens is removed or the mode dial is rotated.

Live view may end automatically to prevent damage to the camera's internal circuits; exit live view when the camera is not in use. Note that the temperature of the camera's internal circuits may rise and noise (bright spots, randomly-spaced bright pixels, or fog) may be displayed in the following instances (the camera may also become noticeably warm, but this does not indicate a malfunction):















- The ambient temperature is high
- The camera has been used for extended periods in live view or to record movies
- The camera has been used in continuous release mode for extended periods

If live view does not start when you attempt to start live view or movie recording, wait for the internal circuits to cool and then try again.

Movie Settings

Use the **Movie settings** option in the shooting menu to adjust the following settings.

- **Frame size/frame rate, Movie quality:** Choose from the following options:

	Frame size/frame rate		Movie quality	Maximum length (★ high quality/Normal)
	Frame size (pixels)	Frame rate *	Maximum bit rate (Mbps) (★ high quality/Normal)	
 	1920 × 1080	60i	24/12	20 min./ 29 min. 59 s
 	1920 × 1080	50i		
 	1920 × 1080	30p		
 	1920 × 1080	25p		
 	1920 × 1080	24p		
 	1280 × 720	60p		
 	1280 × 720	50p		

* Listed value. Actual frame rates for 60p, 50p, 30p, 25p, and 24p are 59.94, 50, 29.97, 25, and 23.976 fps respectively.

- **Microphone:** Turn the built-in or optional ME-1 stereo microphones on or off or adjust microphone sensitivity. Choose **Auto sensitivity** to adjust sensitivity automatically, **Microphone off** to turn sound recording off; to select microphone sensitivity manually, select **Manual sensitivity** and choose a sensitivity.
- **Destination:** Choose the slot to which movies are recorded. The menu shows the time available on each card; recording ends automatically when no time remains.

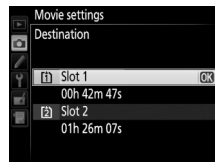

Frame Size/Frame Rate

Settings of **1920×1080; 60i** and **1920×1080; 50i** are not available for **Movie settings > Frame size/frame rate** when **DX (24×16)** is selected for **Image area** in the shooting menu (□ 63). These settings can be accessed by setting **Image area** to **1.3× (18×12)**. Choosing **DX (24×16)** for **Image area** when either of these options is in effect resets **Frame size/frame rate** to **1920×1080; 30p** (if **1920×1080; 60i** is selected) or to **1920×1080; 25p** (if **1920×1080; 50i** is selected).



1 Select **Movie settings**.

Press the **MENU** button to display the menus. Highlight **Movie settings** in the shooting menu and press ►.

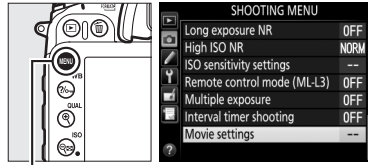

MENU button

2 Choose movie options.

Highlight the desired item and press ►, then highlight an option and press **OK**.



✓ **Frame Size and Rate**







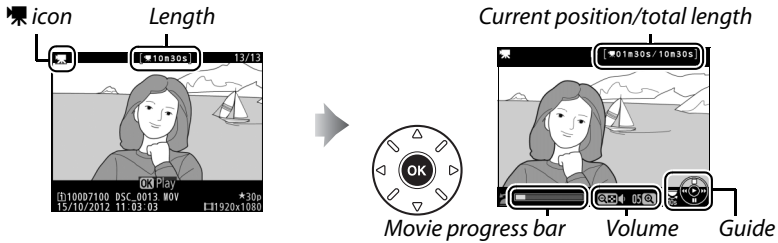

Frame size and rate affects the distribution and amount of noise (randomly-spaced bright pixels, fog, or bright spots).

Viewing Movies

Movies are indicated by a  icon in full-frame playback (185). Press **OK** to start playback.



The following operations can be performed:

To	Use	Description
Pause		Pause playback.
Play	OK	Resume playback when movie is paused or during rewind/advance.
Rewind/advance		Speed increases with each press, from 2x to 4x to 8x to 16x; keep pressed to skip to beginning or end of movie (first frame is indicated by  in top right corner of monitor, last frame by ). If playback is paused, movie rewinds or advances one frame at a time; keep pressed for continuous rewind or advance.
Skip 10 s		Rotate the main command dial to skip ahead or back 10 s.
Skip ahead/back		Rotate the sub-command dial to skip to the last or first frame.
Adjust volume	QUAL / ISO	Press QUAL to increase volume, ISO to decrease.
Trim movie	i	See page 173 for more information.
Exit		Exit to full-frame playback.
Return to shooting mode		Press the shutter-release button halfway to exit to shooting mode.





The Icon

 is displayed in full-frame and movie playback if the movie was recorded without sound.



Editing Movies



Trim footage to create edited copies of movies or save selected frames as JPEG stills.

Option	Description
 Choose start/end point	Create a copy from which the opening or closing footage has been removed.
 Save selected frame	Save a selected frame as a JPEG still.

Trimming Movies

To create trimmed copies of movies:





1 Display a movie full frame.

Press the  button to display pictures full frame in the monitor and press  and  to scroll through pictures until the movie you wish to edit is displayed.



 button

2 Choose a starting or end point.

Play the movie back as described on page 171, pressing  to start and resume playback and  to pause and pressing  or  or rotating the main or sub-command dials to locate the desired frame (171).

Your approximate position in the movie can be ascertained from the movie progress bar.



Movie progress bar

3 Display movie edit options.

Press the  button to display movie edit options.

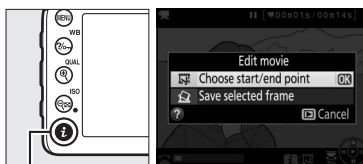

 button

4 Select Choose start/end point.

Highlight **Choose start/end point** and press **OK**.

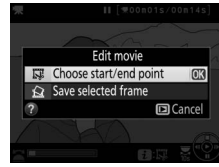

The dialog shown at right will be displayed; choose whether the current frame will be the starting or end point of the copy and press **OK**.

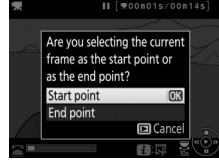

5 Delete frames.

If the desired frame is not currently displayed, press **◀** or **▶** to advance or rewind (to skip to 10 s ahead or back, rotate the main command dial; to skip to the first or last frame, rotate the sub-command dial). To switch the current selection from start point (**↵**) to end point (**↶**) or vice versa, press **?/o-m (WB)**.

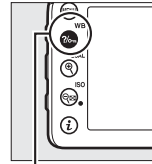

?/o-m (WB) button



Once you have selected the start point and/or end point, press **▲**. All frames before the selected start point and after the selected end point will be removed from the copy.



6 Save the copy.

Highlight one of the following and press **OK**:

- **Save as new file:** Save the copy to a new file.
- **Overwrite existing file:** Replace the original movie file with the edited copy.
- **Cancel:** Return to Step 5.
- **Preview:** Preview the copy.

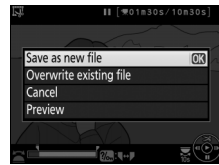

Edited copies are indicated by a  icon in full-frame playback.

Trimming Movies

Movies must be at least two seconds long. If a copy can not be created at the current playback position, the current position will be displayed in red in Step 5 and no copy will be created. The copy will not be saved if there is insufficient space available on the memory card.

Copies have the same time and date of creation as the original.

The Retouch Menu

Movies can also be edited using the **Edit movie** option in the retouch menu (📖 273).

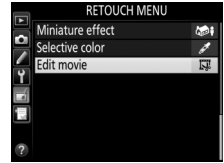

Saving Selected Frames

To save a copy of a selected frame as a JPEG still:

1 View the movie and choose a frame.

Play the movie back as described on page 171; your approximate position in the movie can be ascertained from the movie progress bar. Press ◀ or ▶ to rewind or advance and press ▼ to pause the movie at the frame you intend to copy.



2 Display movie edit options.

Press the **i** button to display movie edit options.

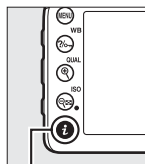

i button

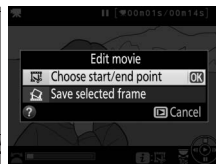

3 Choose Save selected frame.

Highlight **Save selected frame** and press **OK**.

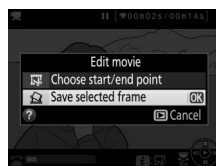

4 Create a still copy.

Press ▲ to create a still copy of the current frame.



5 Save the copy.

Highlight **Yes** and press **OK** to create a fine-quality (66) JPEG copy of the selected frame. Movie stills are indicated by a  icon in full-frame playback.

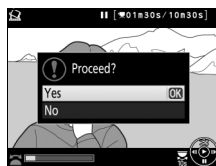

Save Selected Frame

JPEG movie stills created with the **Save selected frame** option can not be retouched. JPEG movie stills lack some categories of photo information (187).

Special Effects

EFFECTS

Special effects can be used when recording images.





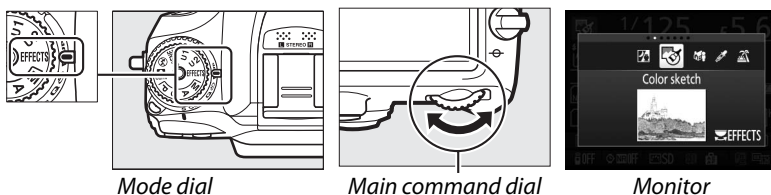

Shooting with Special Effects



To view the currently selected special effect mode, rotate the mode dial to **EFFECTS** and press the **INFO** button. To choose another special effect mode, rotate the main command dial.



NEF (RAW)

If NEF (RAW) + JPEG is selected for image quality in , , , or  mode, only the JPEG images will be recorded (□ 66). If NEF (RAW) is selected, fine-quality JPEG photographs will be recorded instead of NEF (RAW) images.

Continuous Release Modes

When  or  is selected, the frame rate for continuous release will drop. If the memory buffer fills, the camera will display a message indicating that recording is in progress and shooting will be suspended until the message clears from the display.

The Retouch Menu

The **Color sketch** (□ 286), **Miniature effect** (□ 287), and **Selective color** (□ 288) options in the retouch menu can be used to apply these effects to existing pictures.

EFFECTS

Night Vision

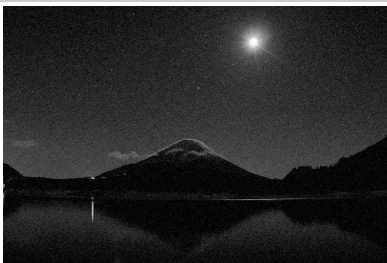

Use under conditions of darkness to record monochrome images at high ISO sensitivities (with some noise in the form of randomly-spaced bright pixels, fog, or lines). Manual focus can be used if the camera is unable to focus using autofocus. The built-in flash turns off; use of a tripod is recommended to reduce blur. During viewfinder photography, the built-in AF-assist illuminator will light to assist the focus operation; to disable the illuminator, select **Off** for Custom Setting a7 (**Built-in AF-assist illuminator**,  233).

Color Sketch



The camera detects and colors outlines for a color sketch effect. Movies shot in this mode play back like a slide show made up of a series of stills. The effect can be chosen during live view ( 180); note that the display refresh rate drops when live view is in effect and that the frame rate drops in continuous release modes. Autofocus is not available during movie recording.

Miniature Effect



Distant subjects appear as miniatures. Miniature effect movies play back at high speed, compressing 30 to 45 minutes of footage shot at 1920 × 1080/30p into a movie that plays back in about 3 minutes. The effect can be chosen during live view ( 181); note that the display refresh rate drops when live view is in effect and that the frame rate drops in continuous release modes. Sound is not recorded with movies; autofocus is not available during movie recording. The built-in flash and AF-assist illuminator turn off; use of a tripod is recommended when lighting is poor.

Selective Color



All colors other than the selected colors are recorded in black and white. The effect can be chosen during live view ( 182). The built-in flash turns off; use of a tripod is recommended when lighting is poor.

Silhouette



Silhouette subjects against bright backgrounds. The built-in flash turns off; use of a tripod is recommended when lighting is poor.

High Key



Use with bright scenes to create bright images that seem filled with light. The built-in flash turns off.

Low Key



Use with dark scenes to create dark, somber images with prominent highlights. The built-in flash turns off; use of a tripod is recommended when lighting is poor.



Options Available in Live View

Color Sketch

1 Press the **Lv** button.

The mirror will be raised and the view through the lens will be displayed in the camera monitor.

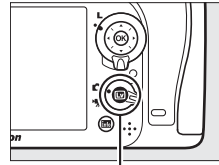

Lv button

2 Adjust options.

Press **OK** to display the options shown at right (note that the options temporarily clear from the display during autofocus). Press **▲** or **▼** to highlight **Vividness** or **Outlines** and press **◀** or **▶** to change. Vividness can be increased to make colors more saturated, or decreased for a washed-out, monochromatic effect, while outlines can be made thicker or thinner. Increasing the thickness of the lines also makes colors more saturated. Press **OK** to exit when settings are complete. To exit live view, press the **Lv** button again. The selected settings will continue in effect and will apply to photographs taken using the viewfinder.

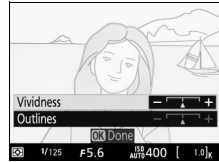

1 Press the **[Lv]** button.

The mirror will be raised and the view through the lens will be displayed in the camera monitor.

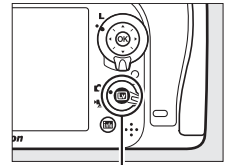

[Lv] button

2 Position the focus point.

Use the multi selector to position the focus point in the area that will be in focus and then press the shutter-release button halfway to focus (note that the options temporarily clear from the display during autofocus). To temporarily clear miniature effect options from the display and enlarge the view in the monitor for precise focus, press **Q (QUAL)**. Press **Q (ISO)** to restore the miniature effect display.

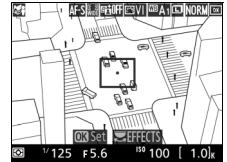

3 Display options.

Press **OK** to display miniature effect options.

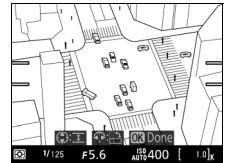

4 Adjust options.

Press **◀** or **▶** to choose the orientation of the area that will be in focus and press **▲** or **▼** to adjust its width.

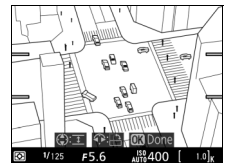

5 Return to the live view display.

Press **OK** to return to live view. To exit live view, press the **[Lv]** button again. The selected settings will continue in effect and will apply to photographs taken using the viewfinder.

■ ■ *Selective Color*

1 Press the **Lv** button.

The mirror will be raised and the view through the lens will be displayed in the camera monitor.

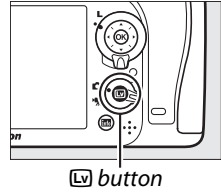

2 Display options.

Press **OK** to display selective color options.



3 Select a color.

Frame an object in the white square in the center of the display and press **▲** to choose the color of the object as one that will remain in the final image (the camera may have difficulty detecting unsaturated colors; choose a saturated color). To zoom in on the center of the display for more precise color selection, press **QUAL**. Press **ISO** to zoom out.



Selected color

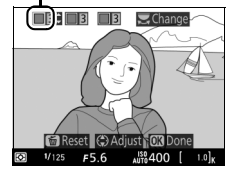

4 Choose the color range.

Press **▲** or **▼** to increase or decrease the range of similar hues that will be included in the final image. Choose from values between 1 and 7; note that higher values may include hues from other colors.



Color range

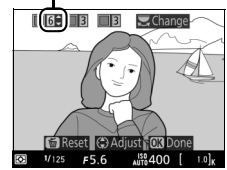

5 Select additional colors.

To select additional colors, rotate the main command dial to highlight another of the 3 color boxes at the top of the display and repeat Steps 3 and 4 to select another color. Repeat for a third color if desired. To deselect the highlighted color, press **FORMAT**. (To remove all colors, press and hold **FORMAT**. A confirmation dialog will be displayed; select **Yes**.)

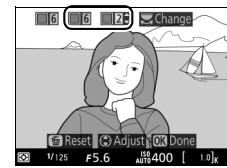

6 Return to the live view display.

Press **OK** to return to live view. During shooting, only objects of the selected hues will be recorded in color; all others will be recorded in black-and-white. To exit live view, press the **LV** button again. The selected settings will continue in effect and will apply to photographs taken using the viewfinder.





More on Playback

Full-Frame Playback

To play photographs back, press the  button. The most recent photograph will be displayed in the monitor.



 button

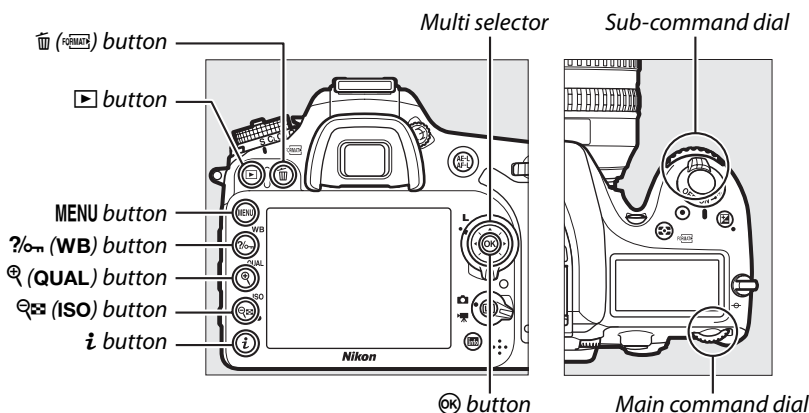

Rotate Tall



To display “tall” (portrait-orientation) photographs in tall orientation, select **On** for the **Rotate tall** option in the playback menu ( 222).



Image Review

When **On** is selected for **Image review** in the playback menu ( 222), photographs are automatically displayed in the monitor for about 4 s after shooting (because the camera is already in the correct orientation, images are not rotated automatically during image review). In continuous release mode, display begins when shooting ends, with the first photograph in the current series displayed.

To	Use	Description
View additional photographs		Press ► to view photographs in order recorded, ◀ to view photographs in reverse order.
View photo information		Press ▲ or ▼ to view information about current photograph (□ 187).
View thumbnails		See page 193 for more information.
Zoom in on photograph		See page 195 for more information.
Delete images		Confirmation dialog will be displayed. Press again to delete photo.
Change protect status		To protect image, or to remove protection from protected image, press (□ 196).
Return to shooting mode		Monitor will turn off. Photographs can be taken immediately.
Retouch photo or trim movie		Create retouched or trimmed copy of current photograph or movie (□ 173, 273).
Play movie		If current picture is marked with icon to show that it is a movie, pressing starts movie playback (□ 171).

Choosing a Memory Card Slot

If two memory cards are inserted, you can select a card for playback by holding the **BKT** button and pressing ▲ during full-frame or thumbnail playback. The dialog shown at right will be displayed; highlight the desired slot and press ► to list the folders on the selected card, then highlight a folder and press to view the pictures in the highlighted folder. The same procedure can be used when selecting pictures for operations in the playback (□ 217) and retouch (□ 273) menus or when copying white balance from an existing photograph (□ 101).

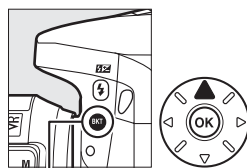

BKT button

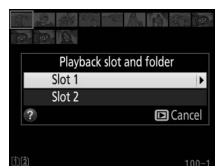

See Also

For information on choosing how long the monitor will remain on when no operations are performed, see Custom Setting c4 (**Monitor off delay**, □ 238). For information on using the command dials to view additional photographs or photo information, see Custom Setting f5 (**Customize command dials**) > **Menus and playback** (□ 257).

Photo Information

Photo information is superimposed on images displayed in full-frame playback. Press ▲ or ▼ to cycle through photo information as shown below. Note that “image only”, shooting data, RGB histograms, highlights, and overview data are only displayed if corresponding option is selected for **Playback display options** (☐ 219). GPS data are only displayed if a GPS unit was used when the photo was taken.

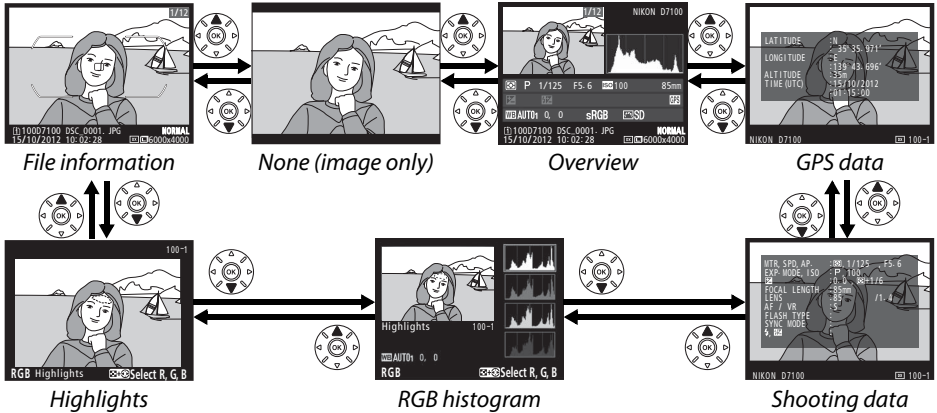

File Information

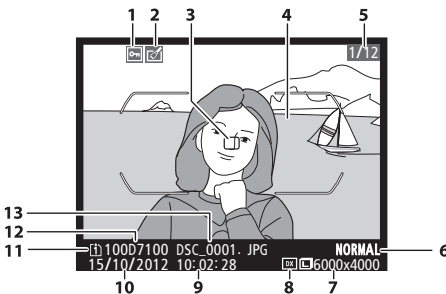

1	Protect status	196
2	Retouch indicator	273
3	Focus point ^{1, 2}	75
4	AF area brackets ¹	33
5	Frame number/total number of frames	
6	Image quality	66
7	Image size.....	68
8	Image area.....	63
9	Time of recording	28, 265
10	Date of recording.....	28, 265
11	Current card slot.....	69, 186
12	Folder name.....	225
13	File name.....	226

- 1 Displayed only if **Focus point** is selected for **Playback display options** (☐ 219).
- 2 If photograph was taken using **AF-S** or with single-servo autofocus selected during **AF-A**, display shows focus point where focus first locked. If photograph was taken using **AF-C** or with continuous-servo autofocus selected during **AF-A**, focus point is only displayed if option other than auto-area AF was selected for AF-area mode and camera was able to focus.



Highlights

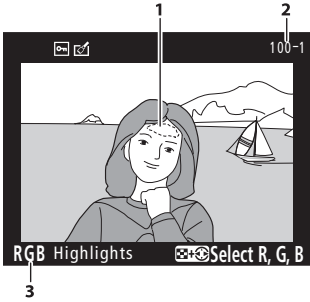

- 1 Image highlights*
- 2 Folder number—frame number 225
- 3 Current channel*

* Flashing areas indicate highlights (areas that may be overexposed) for the current channel. Hold **Q** (ISO) button and press **◀** or **▶** to cycle through channels as follows:

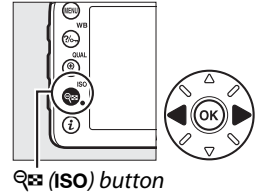

RGB Histogram

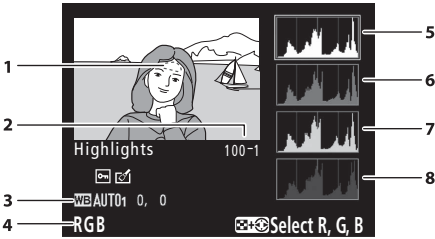

- 3 White balance89
Color temperature.....94
White balance fine-tuning91
Preset manual95
- 4 Current channel*
- 5 Histogram (RGB channel). In all histograms, horizontal axis gives pixel brightness, vertical axis number of pixels.
- 6 Histogram (red channel)
- 7 Histogram (green channel)
- 8 Histogram (blue channel)

- 1 Image highlights*
- 2 Folder number—frame number..... 225

* Flashing areas indicate highlights (areas that may be overexposed) for the current channel. Hold **Q** (ISO) button and press **◀** or **▶** to cycle through channels as follows:

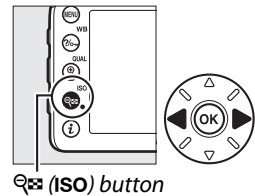
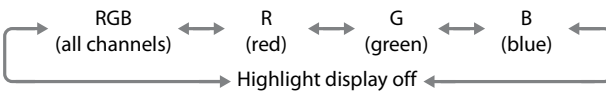

Playback Zoom

To zoom in on the photograph when the histogram is displayed, press **Q (QUAL)**. Use the **Q (QUAL)** and **ISO** buttons to zoom in and out and scroll the image with the multi selector. The histogram will be updated to show only the data for the portion of the image visible in the monitor.



Histograms

Camera histograms are intended as a guide only and may differ from those displayed in imaging applications. Some sample histograms are shown below:

If the image contains objects with a wide range of brightnesses, the distribution of tones will be relatively even.



If the image is dark, tone distribution will be shifted to the left.



If the image is bright, tone distribution will be shifted to the right.



Increasing exposure compensation shifts the distribution of tones to the right, while decreasing exposure compensation shifts the distribution to the left. Histograms can provide a rough idea of overall exposure when bright ambient lighting makes it difficult to see photographs in the monitor.



■ Shooting Data

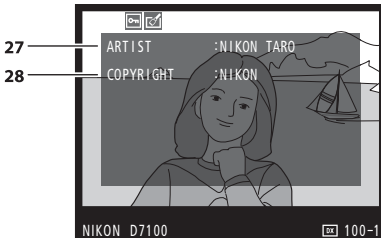
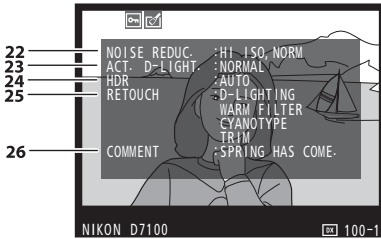
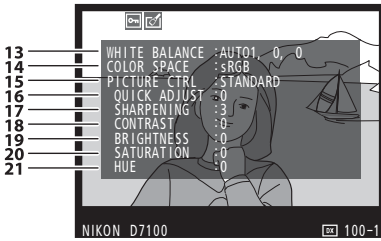
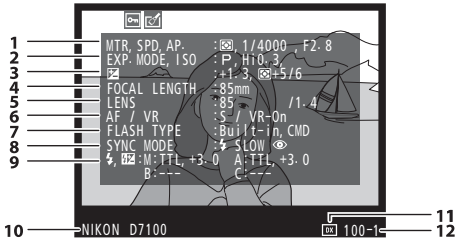

1	Metering	83
	Shutter speed	49, 51
	Aperture	50, 51
2	Shooting mode	36, 41, 47, 177
	ISO sensitivity ¹	79

3	Exposure compensation	86
	Optimal exposure tuning ²	236
4	Focal length	149, 302
5	Lens data	149
6	Focus mode	71, 78
	Lens VR (vibration reduction) ³	
7	Flash type	119, 303
	Commander mode	247
8	Flash mode	120
9	Flash control	246, 305, 306
	Flash compensation	124
10	Camera name	
11	Image area	63
12	Folder number—frame number	225
13	White balance	89
	Color temperature	94
	White balance fine-tuning	91
	Preset manual	95
14	Color space	227
15	Picture Control	105
16	Quick adjust ⁴	108
	Original Picture Control ⁵	111
17	Sharpening	108
18	Contrast	108
19	Brightness	108
20	Saturation ⁶	108
	Filter effects ⁷	108, 109
21	Hue ⁶	108
	Toning ⁷	108, 109
22	High ISO noise reduction	228
	Long exposure noise reduction	228
23	Active D-Lighting	113
24	HDR strength	115
25	Retouch history	273
26	Image comment	266
27	Name of photographer ⁸	267
28	Copyright holder ⁸	267

- 1 Displayed in red if photo was taken with auto ISO sensitivity control on.
- 2 Displayed if Custom Setting b5 (**Fine-tune optimal exposure**, ) has been set to a value other than zero for any metering method.
- 3 Displayed only if VR lens is attached.
- 4 **Standard, Vivid, Portrait**, and **Landscape** Picture Controls only.
- 5 **Neutral, Monochrome**, and custom Picture Controls.
- 6 Not displayed with monochrome Picture Controls.
- 7 Monochrome Picture Controls only.
- 8 The fourth page of the shooting data is only displayed if copyright information was recorded with the photograph as described on page 267.

■ ■ GPS Data*

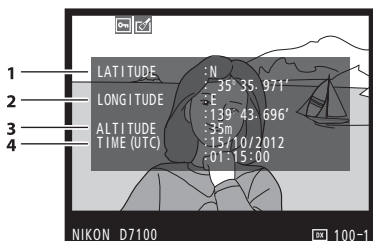

- | | |
|---|----------------------------------|
| 1 | Latitude |
| 2 | Longitude |
| 3 | Altitude |
| 4 | Coordinated Universal Time (UTC) |

* Data for movies are for start of recording.



Overview Data

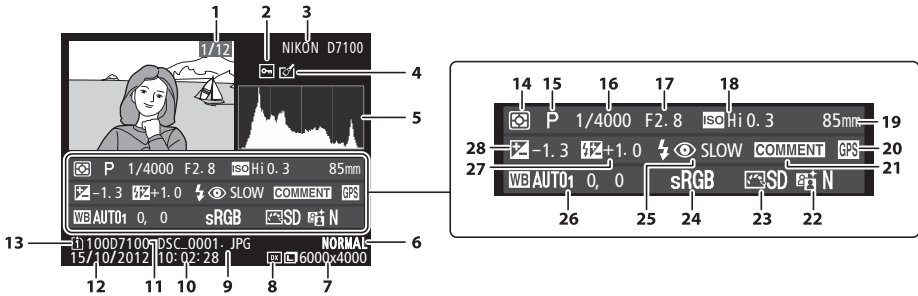

1	Frame number/total number of images	
2	Protect status	196
3	Camera name	
4	Retouch indicator	273
5	Histogram showing the distribution of tones in the image (189).	
6	Image quality	66
7	Image size	68
8	Image area	63
9	File name	226
10	Time of recording	28, 265
11	Folder name	225
12	Date of recording	28, 265
13	Current card slot	69, 186
14	Metering	83
15	Shooting mode	36, 41, 47, 177
16	Shutter speed	49, 51

17	Aperture	50, 51
18	ISO sensitivity*	79
19	Focal length	149, 302
20	GPS data indicator	152
21	Image comment indicator	266
22	Active D-Lighting	113
23	Picture Control	105
24	Color space	227
25	Flash mode	120
26	White balance	89
	Color temperature	94
	White balance fine-tuning	91
	Preset manual	95
27	Flash compensation	124
	Commander mode	247
28	Exposure compensation	86

* Displayed in red if photo was taken with auto ISO sensitivity control on.

Thumbnail Playback

To display images in “contact sheets” of four, nine, or 72 images, press the **ISO** button.

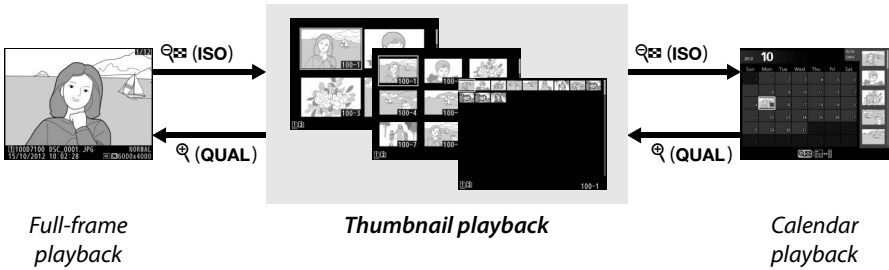

To	Use	Description
Display more images	ISO	Press ISO to increase the number of images displayed.
Display fewer images	QUAL	Press QUAL to reduce the number of images displayed. When four images are displayed, press to view highlighted image full frame.
Highlight images		Use multi selector to highlight images for full-frame playback, playback zoom (195), deletion (197), or protection (196).
View highlighted image	OK	Press OK to display the highlighted image full frame.
Delete highlighted image		See page 197 for more information.
Change protect status of highlighted image	WB	See page 196 for more information.
Return to shooting mode		Monitor will turn off. Photographs can be taken immediately.
Retouch photo or trim movie	i	Create retouched or trimmed copy of current photograph or movie (173, 273).







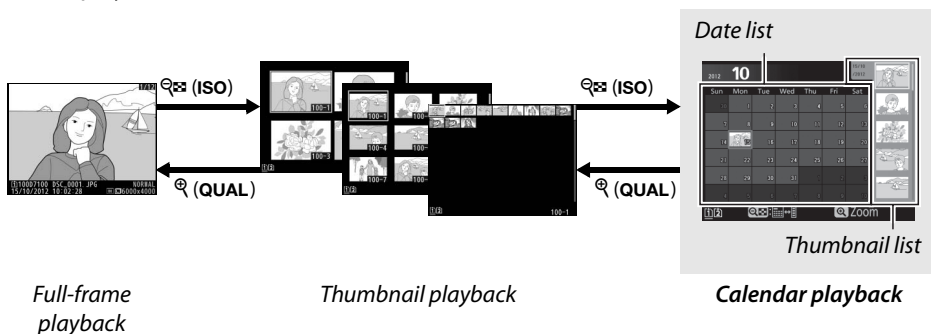











Calendar Playback

To view images taken on a selected date, press the  (ISO) button when 72 images are displayed.

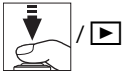







The operations can be performed depend on whether the cursor is in the date list or the thumbnail list:

To	Use	Description
Toggle between date list and thumbnail list	 (ISO)/ 	Press  (ISO) or  button in date list to place cursor in thumbnail list. Press  (ISO) again to return to date list.
Exit to thumbnail playback/Zoom in on highlighted photo	 (QUAL)	<ul style="list-style-type: none"> Date list: Exit to 72-frame playback. Thumbnail list: Press and hold  (QUAL) button to zoom in on highlighted picture.
Highlight dates/Highlight images		<ul style="list-style-type: none"> Date list: Highlight date. Thumbnail list: Highlight picture.
Toggle full frame playback		<ul style="list-style-type: none"> Thumbnail list: View highlighted picture.
Delete highlighted photo(s)		<ul style="list-style-type: none"> Date list: Delete all pictures taken on selected date. Thumbnail list: Delete highlighted picture ( 197).
Change protect status of highlighted photo	 (WB)	See page 196 for more information.
Return to shooting mode		Monitor will turn off. Photographs can be taken immediately.
Retouch photo or trim movie		Create retouched or trimmed copy of photograph or movie highlighted in thumbnail list ( 173,  273).

Taking a Closer Look: Playback Zoom

Press the **Q (QUAL)** button to zoom in on the image displayed in full-frame playback or on the image currently highlighted in thumbnail playback. The following operations can be performed while zoom is in effect:

To	Use	Description
Zoom in or out	Q (QUAL) / ISO	Press Q (QUAL) to zoom in to maximum of approximately 38× (large images in 24 × 16/DX format), 28× (medium images) or 19× (small images). Press ISO to zoom out. While photo is zoomed in, use multi selector to view areas of image not visible in monitor. 
View other areas of image		Keep multi selector pressed to scroll rapidly to other areas of frame. Navigation window is displayed when zoom ratio is altered; area currently visible in monitor is indicated by yellow border.
Select faces		Faces (up to 35) detected during zoom are indicated by white borders in navigation window. Rotate sub-command dial to view other faces. 
View other images		Rotate main command dial to view same location in other photos at current zoom ratio. Playback zoom is cancelled when a movie is displayed.
Change protect status	W/B	See page 196 for more information.
Return to shooting mode		Monitor will turn off. Photographs can be taken immediately.
Retouch photo	i	Create retouched copy of current photograph (273).



Protecting Photographs from Deletion

In full-frame, zoom, thumbnail, and calendar playback, the **WB** button can be used to protect photographs from accidental deletion. Protected files can not be deleted using the **FORMAT** button or the **Delete** option in the playback menu. Note that protected images *will* be deleted when the memory card is formatted (32, 262).

To protect a photograph:

1 Select an image.

Display the image in full-frame playback or playback zoom or highlight it in the thumbnail list in thumbnail or calendar playback.



Full-frame playback

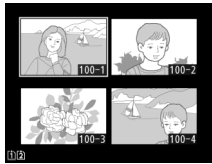

Thumbnail playback



Calendar playback

2 Press the **WB** button.

The photograph will be marked with a **WB** icon. To remove protection from the photograph so that it can be deleted, display the photograph or highlight it in the thumbnail list and then press the **WB** button.

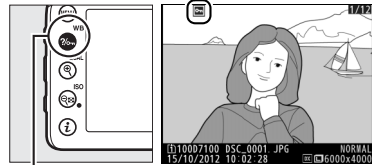

WB button

Removing Protection from All Images

To remove protection from all images in the folder or folders currently selected in the **Playback folder** menu, press the **WB** and **FORMAT** buttons together for about two seconds during playback.

Deleting Photographs

To delete the photograph displayed in full-frame playback or highlighted in the thumbnail list, press the  button. To delete multiple selected photographs, all photographs taken on a selected date, or all photographs in the current playback folder, use the **Delete** option in the playback menu. Once deleted, photographs can not be recovered. Note that pictures that are protected or hidden can not be deleted.

Full-Frame, Thumbnail, and Calendar Playback

Press the  button to delete the current photograph.

1 Select an image.

Display the image or highlight it in the thumbnail list in thumbnail or calendar playback.

2 Press the button.

A confirmation dialog will be displayed.

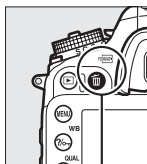

 button



Full-frame playback

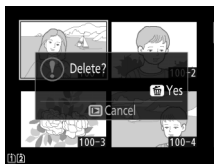



Thumbnail playback



Calendar playback
(thumbnail list)

3 Press the button again.

To delete the photograph, press the  button. To exit without deleting the photograph, press the  button.

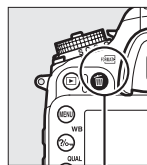

 button

Calendar Playback



During calendar playback, you can delete all photographs taken on a selected date by highlighting the date in the date list and pressing the  button ([□ 194](#)).

See Also

The **After delete** option in the playback menu determines whether the next image or the previous image is displayed after an image is deleted ([□ 222](#)).

The Playback Menu

The **Delete** option in the playback menu contains the following options. Note that depending on the number of images, some time may be required for deletion.

Option	Description
 Selected	Delete selected pictures.
 Select date	Delete all pictures taken on a selected date (□ 199).
ALL All	Delete all pictures in the folder currently selected for playback (□ 217). If two cards are inserted, you can select the card from which pictures will be deleted.

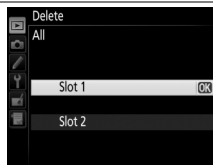

■ Selected: Deleting Selected Photographs

1 Choose Selected for the Delete option in the playback menu.

Press the **MENU** button and select **Delete** in the playback menu. Highlight **Selected** and press **▶**.

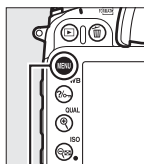

MENU button

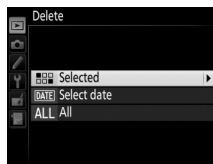

2 Highlight a picture.

Use the multi selector to highlight a picture (to view the highlighted picture full screen, press and hold the **QUAL** button; to view images in other locations, hold the **BKT** button, press **▲**, and select the desired card and folder as described on page 186).



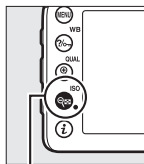

3 Select the highlighted picture.

Press the **ISO** button to select the highlighted picture. Selected pictures are marked by a  icon. Repeat Steps 2 and 3 to select additional pictures; to deselect a picture, highlight it and press **ISO**.



ISO button



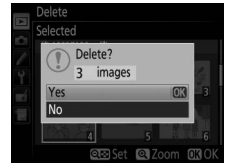

- 4 Press  to complete the operation.**
A confirmation dialog will be displayed;
highlight **Yes** and press .





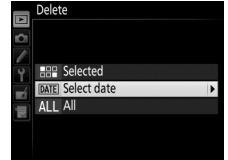

■ Select Date: Deleting Photographs Taken on a Selected Date

- 1 Choose Select date.**
In the delete menu, highlight **Select date**
and press .

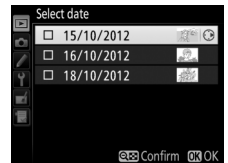

- 2 Highlight a date.**
Press  or  to highlight a date.



To view the pictures taken on the highlighted date, press  (ISO). Use the multi selector to scroll through the pictures, or press and hold  (QUAL) to view the current picture full screen. Press  (ISO) to return to the date list.

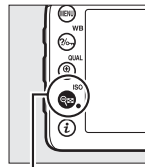



 (ISO) button

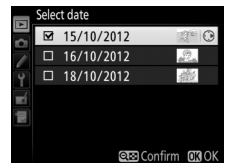

- 3 Select the highlighted date.**
Press  to select all pictures taken on the highlighted date. Selected dates are marked with a  icon. Repeat Steps 2 and 3 to select additional dates; to deselect a date, highlight it and press .



- 4 Press  to complete the operation.**
A confirmation dialog will be displayed;
highlight **Yes** and press .





Connections

Installing ViewNX 2

Install the supplied software to display and edit photographs and movies that have been copied to your computer. Before installing ViewNX 2, confirm that your computer meets the system requirements on page 202. Be sure to use the latest version of ViewNX 2, which is available for download from the websites listed on page xxvi, as earlier versions that do not support the D7100 may fail to transfer NEF (RAW) images correctly.



1 Launch the installer.

Start the computer, insert the ViewNX 2 installer CD, and launch the installer.

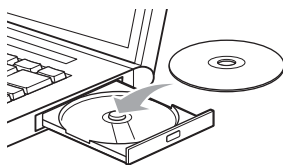

2 Select a language.

If the desired language is not available, click **Region Selection** to choose a different region and then choose the desired language (region selection is not available in the European release).

① Select region (if required)

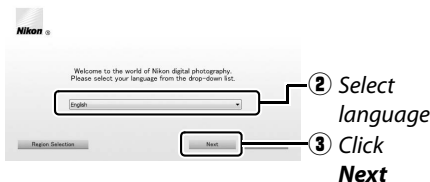

3 Start the installer.

Click **Install** and follow the on-screen instructions.

Installation Guide

For help installing ViewNX 2, click **Installation Guide** in Step 3.



4 Exit the installer.



The following software is installed:

- ViewNX 2
- Apple QuickTime (Windows only)

5 Remove the installer CD from the CD-ROM drive.

System Requirements

	Windows	Mac OS
CPU	<ul style="list-style-type: none"> • Photos/JPEG movies: Intel Celeron, Pentium 4, or Core series, 1.6 GHz or better • H.264 movies (playback): 3.0 GHz or better Pentium D; Intel Core i5 or better recommended when viewing movies with a frame size of 1280 × 720 or more at a frame rate of 30 fps or above or movies with a frame size of 1920 × 1080 or more • H.264 movies (editing): 2.6 GHz or better Core 2 Duo 	<ul style="list-style-type: none"> • Photos/JPEG movies: Intel Core or Xeon series • H.264 movies (playback): Core Duo 2 GHz or better; Intel Core i5 or better recommended when viewing movies with a frame size of 1280 × 720 or more at a frame rate of 30 fps or above or movies with a frame size of 1920 × 1080 or more • H.264 movies (editing): 2.6 GHz or better Core 2 Duo
OS	Pre-installed versions of Windows XP, Windows Vista, Windows 7, and Windows 8; only 32-bit versions of Windows XP are supported	Mac OS X version 10.6, 10.7, or 10.8
RAM	<ul style="list-style-type: none"> • Windows 8/Windows 7/Windows Vista: 1 GB or more (2 GB or more recommended) • Windows XP: 512 MB or more (2 GB or more recommended) 	512 MB or more (2 GB or more recommended)
Hard-disk space	A minimum of 500 MB available on the startup disk (1 GB or more recommended)	
Monitor	Resolution: 1024 × 768 pixels (XGA) or more (1280 × 1024 pixels (SXGA) or more recommended) Color: 24-bit color (True Color) or more	Resolution: 1024 × 768 pixels (XGA) or more (1280 × 1024 pixels (SXGA) or more recommended) Color: 24-bit color (millions of colors) or more

See the websites listed on page xxvii for the latest information on supported operating systems.

Using ViewNX 2

Copy Pictures to the Computer

Before proceeding, be sure you have installed the software on the supplied ViewNX 2 CD (© 201).

1 Choose how pictures will be copied to the computer.

Choose one of the following methods:

- **Direct USB connection:** Turn the camera off and ensure that the memory card is inserted in the camera. Connect the camera to the computer using the supplied UC-E6 USB cable and then turn the camera on.

Use a Reliable Power Source

To ensure that data transfer is not interrupted, be sure the camera EN-EL15 battery is fully charged. If in doubt, charge the battery before use or use an EH-5b AC adapter and EP-5B power connector (available separately).

USB Hubs

Connect the camera directly to the computer; do not connect the cable via a USB hub or keyboard.

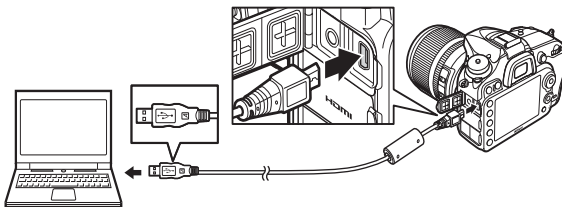

- **SD card slot:** If your computer is equipped with an SD card slot, the card can be inserted directly in the slot.
- **SD card reader:** Connect a card reader (available separately from third-party suppliers) to the computer and insert the memory card.

2 Start Nikon Transfer 2 component of ViewNX 2.

If a message is displayed prompting you to choose a program, select Nikon Transfer 2.

Windows 7

If the following dialog is displayed, select Nikon Transfer 2 as described below.

- 1 Under **Import pictures and videos**, click **Change program**. A program selection dialog will be displayed; select **Import file using Nikon Transfer 2** and click **OK**.

- 2 Double-click **Import file**.



3 Click Start Transfer.

At default settings, all the pictures on the memory card will be copied to the computer.



Start Transfer

4 Terminate the connection.

If the camera is connected to the computer, turn the camera off and disconnect the USB cable. If you are using a card reader or card slot, choose the appropriate option in the computer operating system to eject the removable disk corresponding to the memory card and then remove the card from the card reader or card slot.

View Pictures

Pictures are displayed in ViewNX 2 when transfer is complete.

Starting ViewNX 2 Manually

- Windows: Double-click the ViewNX 2 shortcut on the desktop.
- Mac OS: Click the ViewNX 2 icon in the Dock.

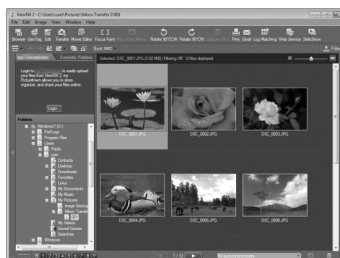

■ ■ Retouching Photographs

To crop pictures and perform such tasks as adjusting sharpness and tone levels, click the **Edit** button in the ViewNX 2 toolbar.

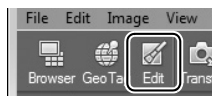

■ ■ Editing Movies

To perform such tasks as trimming unwanted footage from movies shot with the camera, click the **Movie Editor** button in the ViewNX 2 toolbar.



■ ■ Printing Pictures

Click the **Print** button in the ViewNX 2 toolbar. A dialog will be displayed, allowing you to print pictures on a printer connected to the computer.



For More Information

Consult online help for more information on using ViewNX 2.

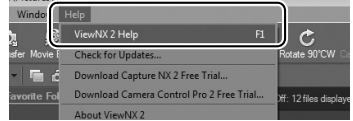

Connecting Cables

Be sure the camera is off when connecting or disconnecting interface cables. Do not use force or attempt to insert the connectors at an angle. Close the connector cover when the connector is not in use.

During Transfer

Do not turn the camera off or disconnect the USB cable while transfer is in progress.

Windows

To visit the Nikon website after installing ViewNX 2, select **All Programs > Link to Nikon** from the Windows start menu (Internet connection required).



Ethernet and Wireless Networks

The optional UT-1 communication unit (□ 310) requires Wireless Transmitter Utility version 1.4.0 or later (the Wireless Transmitter Utility is supplied with the UT-1; the latest versions of the UT-1 firmware and Wireless Transmitter Utility can be downloaded from the websites listed on page xxvi). When used with the D7100, the UT-1 requires firmware version 1.1 or later (the firmware version can be displayed by connecting the UT-1 and selecting **Network > Options > Firmware version** in the setup menu; □ 261). When connected to the camera via the USB cable supplied with the camera, the UT-1 can be used to upload pictures to a computer or ftp server over Ethernet networks or, if an optional WT-5 wireless transmitter (□ 310) is connected to the UT-1, wireless LANs.

■ ■ Available Modes

The following modes are available when the camera is connected to a network using the UT-1 or the UT-1 and a WT-5 wireless transmitter:

Mode	Function
FTP upload	Upload existing photos and movies to a computer or ftp server, or upload new photos as they are taken.
Image transfer	
Camera control	Control camera from computer using Camera Control Pro 2 (available separately).

For more information, see the documentation provided with the UT-1 and/or WT-5.

Image Upload

When the UT-1 is connected, the **i** button functions during playback to select pictures for upload in ftp and image transfer modes. Other playback operations that use the **i** button, such as **Side-by-side comparison** (☐ 290), can not be performed even if the camera is not currently connected to a network. These functions can however be accessed by selecting an option other than **FTP upload** or **Image transfer** for **Connection type**.

During Transfer

Movies can not be recorded or played back when the UT-1 is connected and there are either images remaining to be sent or images currently being transferred via an Ethernet or wireless network.

Movies

Movies can be uploaded over Ethernet and wireless networks in transfer mode. Note, however, that movies can not be uploaded using the **Auto send** or **Send folder** features in the **Options** menu.

WT-5 Wireless Transmitters

The principal differences between the the WT-5 and WT-5A/B/C/D/E is in the number of channels supported; unless otherwise stated, all references to the the WT-5 also apply to the WT-5A/B/C/D/E.

Camera Control Pro 2

Camera Control Pro 2 software (available separately; ☐ 309) can be used to control the camera from a computer. When Camera Control Pro 2 is used to capture photographs and movies directly to the computer, the PC connection indicator () will appear in the control panel.



Printing Photographs

Selected JPEG images can be printed on a PictBridge printer (☞ 346) connected directly to the camera.

Connecting the Printer

Connect the camera using the supplied UC-E6 USB cable.

1 Turn the camera off.

2 Connect the USB cable.

Turn the printer on and connect the USB cable as shown. Do not use force or attempt to insert the connectors at an angle.

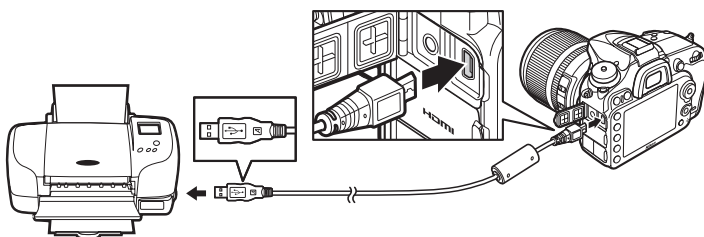

USB Hubs

Connect the camera directly to the printer; do not connect the cable via a USB hub.

3 Turn the camera on.

A welcome screen will be displayed in the monitor, followed by a PictBridge playback display.

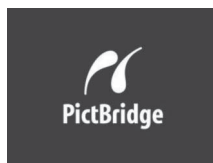

Printing Via Direct USB Connection

Be sure the EN-EL15 battery is fully charged or use an optional EH-5b AC adapter and EP-5B power connector. When taking photographs to be printed via direct USB connection, set **Color space** to **sRGB** (☞ 227).

Selecting Photographs for Printing



NEF (RAW) photographs (☞ 66) can not be selected for printing. JPEG copies of NEF (RAW) images can be created using the **NEF (RAW) processing** option in the retouch menu (☞ 282).

See Also

See page 335 for information on what to do if an error occurs during printing.

Printing Pictures One at a Time

1 Select a picture.

Press ◀ or ▶ to view additional pictures. Press the  (QUAL) button to zoom in on the current frame (□ 195; press □ to exit zoom). To view six pictures at a time, press the  (ISO) button. Use the multi selector to highlight pictures, or press  (QUAL) to display the highlighted picture full frame; to view images in other locations when thumbnails are displayed, hold the **BKT** button, press ▲, and select the desired card and folder as described on page 186.











2 Display printing options.

Press  to display PictBridge printing options.





3 Adjust printing options.

Press ▲ or ▼ to highlight an option and press ▶ to select.

Option	Description
Page size	Highlight a page size (only sizes supported by the current printer are listed) and press  to select and exit to the previous menu (to print at the default page size for the current printer, select Printer default).
No. of copies	Press ▲ or ▼ to choose number of copies (maximum 99), then press  to select and return to the previous menu.
Border	This option is available only if supported by the printer. Highlight Printer default (use current printer settings), Print with border (print photo with white border), or No border and press  to select and exit to the previous menu.
Time stamp	Highlight Printer default (use current printer settings), Print time stamp (print times and dates of recording on photos), or No time stamp and press  to select and exit to the previous menu.
Cropping	This option is available only if supported by the printer. To exit without cropping, highlight No cropping and press  . To crop the current picture, highlight Crop and press ▶. A crop selection dialog will be displayed; press  (QUAL) to increase the size of the crop,  (ISO) to decrease. Position the crop using the multi selector and press  . Note that print quality may drop if small crops are printed at large sizes.

4 Start printing.

Select **Start printing** and press  to start printing. To cancel before all copies have been printed, press .



Printing Multiple Pictures

1 Display the PictBridge menu.

Press the **MENU** button in the PictBridge playback display (see Step 3 on page 208).

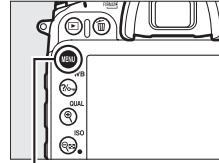

MENU button

2 Choose an option.

Highlight one of the following options and press ►.

- **Print select:** Select pictures for printing.
- **Select date:** Print one copy of all the pictures taken on a selected date.
- **Print (DPOF):** Print an existing print order created with the **DPOF print order** option in the playback menu (☞ 213). The current print order will be displayed in Step 3.
- **Index print:** To create an index print of all JPEG pictures (☞ 66) on the memory card, proceed to Step 4. Note that if the memory card contains more than 256 pictures, only the first 256 images will be printed.



3 Select pictures or choose a date.

If you chose **Print select** or **Print (DPOF)** in Step 2, press ◀ or ▶ to scroll through the pictures on the memory card; to view images in other locations, hold the **BKT** button, press ▲, and select the desired card and folder as described on page 186. To display the current picture full screen, press and hold the **QUAL** button. To select the current picture for printing, press ▲. The picture will be marked with a  icon and the number of prints will be set to 1. Press ▲ or ▼ to specify the number of prints (up to 99; to deselect the picture, press ▼ when the number of prints is 1). Continue until all the desired pictures have been selected.

If you chose **Select date** in Step 2, press ▲ or ▼ to highlight a date and press ▶ to toggle the highlighted date on or off. To view the pictures taken on the selected date, press **ISO**. Use the multi selector to scroll through the pictures, or press and hold **QUAL** to view the current picture full screen. Press **ISO** again to return to the date selection dialog.

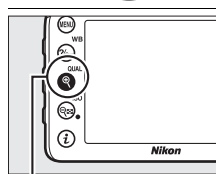

QUAL button: View photo full screen

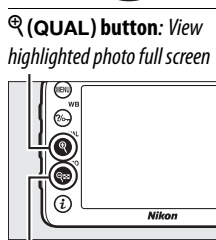

ISO button: View photos for selected date



4 Display printing options.



Press  to display PictBridge printing options.



5 Adjust printing options.

Choose page size, border, and time stamp options as described on page 209 (a warning will be displayed if the selected page size is too small for an index print).

6 Start printing.

Select **Start printing** and press  to start printing. To cancel before all copies have been printed, press .



Creating a DPOF Print Order: Print Set

The **DPOF print order** option in the playback menu is used to create digital “print orders” for PictBridge-compatible printers and devices that support DPOF.

1 Choose Select/set for the DPOF print order item in the playback menu.

Press the **MENU** button and select **DPOF print order** in the playback menu. Highlight **Select/set** and press **▶** (to remove all photographs from the print order, select **Deselect all?**).

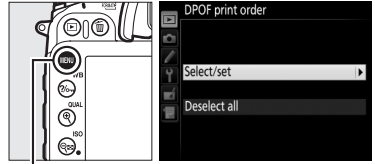

MENU button

2 Select pictures.

Press **◀** or **▶** to scroll through the pictures on the memory card (to view images in other locations, hold the **BKT** button and press **▲**). To display the current picture in full screen, press and hold the **QUAL** button. To select the current picture for printing, press **▲**. The picture will be marked with a  icon and the number of prints will be set to 1. Press **▲** or **▼** to specify the number of prints (up to 99; to deselect the picture, press **▼** when the number of prints is 1). Continue until all the desired pictures have been selected.

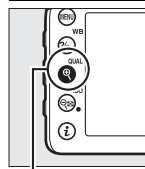
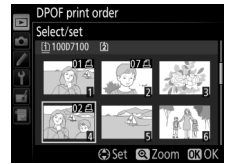

QUAL button: View photo full screen

3 Display imprint options.

Press **OK** to display data imprint options.

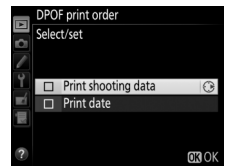

4 Select imprint options.

Highlight the following options and press ► to toggle the highlighted option on or off (to complete the print order without including this information, proceed to Step 5).

- **Print shooting data:** Print shutter speed and aperture on all pictures in print order.
- **Print date:** Print date of recording on all pictures in print order.

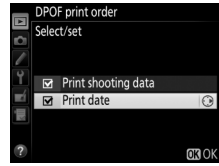

5 Complete the print order.

Press **OK** to complete the print order.



✓ DPOF Print Order

To print the current print order when the camera is connected to a PictBridge printer, select **Print (DPOF)** in the PictBridge menu and follow the steps in "Printing Multiple Pictures" to modify and print the current order (☐ 210). DPOF print date and shooting data options are not supported when printing via direct USB connection; to print the date of recording on photographs in the current print order, use the PictBridge **Time stamp** option.

The **DPOF print order** option can not be used if there is not enough space on the memory card to store the print order.

NEF (RAW) photographs (☐ 66) can not be selected using this option. JPEG copies of NEF (RAW) images can be created using the **NEF (RAW) processing** option in the retouch menu (☐ 282).

Print orders may not print correctly if images are deleted using a computer or other device after the print order is created.

Viewing Photographs on TV

The camera can be connected to high-definition video devices using a High-Definition Multimedia Interface (HDMI) cable (available separately from commercial sources). The cable must have a HDMI mini connector (Type C) for connection to the camera.

1 Turn the camera off.

Always turn the camera off before connecting or disconnecting an HDMI cable.

2 Connect the HDMI cable as shown.

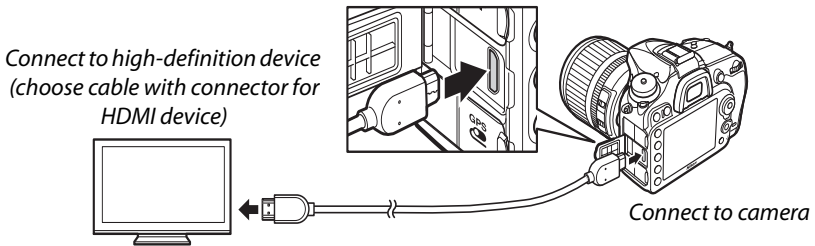

3 Tune the device to the HDMI channel.

4 Turn the camera on and press the button.

During playback, images will be displayed on the television screen.

Close the Connector Cover

Close the camera connector cover when the connectors are not in use. Foreign matter in the connectors can interfere with data transfer.

Television Playback

Use of an EH-5b AC adapter and EP-5B power connector (available separately) is recommended for extended playback. The TV will display images full screen if photo information is hidden during full-frame playback (187). Note that the edges may not be visible when photographs are viewed on a television screen.

Audio

Audio will not be played back over headphones connected to the camera. Volume can be adjusted using television controls; the camera controls can not be used.



■ ■ HDMI Options

The **HDMI** option in the setup menu (☐ 261) controls output resolution and can be used to enable the camera for remote control from devices that support HDMI-CEC (High-Definition Multimedia Interface–Consumer Electronics Control, a standard that allows HDMI devices to be used to control peripherals to which they are connected).

Output Resolution

Choose the format for images output to the HDMI device. If **Auto** is selected, the camera will automatically select the appropriate format.

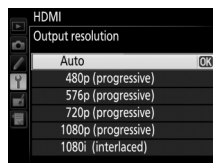

Device Control

If **On** is selected for **HDMI > Device control** in the setup menu when the camera is connected to a television that supports HDMI-CEC and both the camera and television are on, the display shown at right will appear on the television and the television remote can be used in place of the camera multi selector and OK button during full-frame playback and slide shows. If **Off** is selected, the television remote can not be used to control the camera.

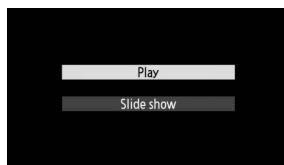

✍ HDMI and Live View

HDMI displays connected via an HDMI cable can be used for live view photography and movie live view (☐ 160, 168). During movie live view and movie recording, images will be output to the HDMI device at the resolution selected for **HDMI > Output resolution** in the setup menu. If **Auto** is selected, HDMI output will be adjusted according to the option selected for **Movie settings > Frame size/frame rate** in the shooting menu (☐ 169). If the HDMI device does not support the setting automatically selected at the current frame size and rate, choose an option other than **Auto** for **Output resolution**. Movies may be output at a frame size smaller than that selected for **Frame size/frame rate** (☐ 169).

✍ HDMI-CEC Devices

When the camera is connected to an HDMI-CEC device, $\llcorner \llcorner \llcorner$ will appear in the control panel in place of the number of exposures remaining.

✍ Device Control

See the television manual for details.

Menu Guide

▶ The Playback Menu: *Managing Images*

To display the playback menu, press **MENU** and select the ▶ (playback menu) tab.

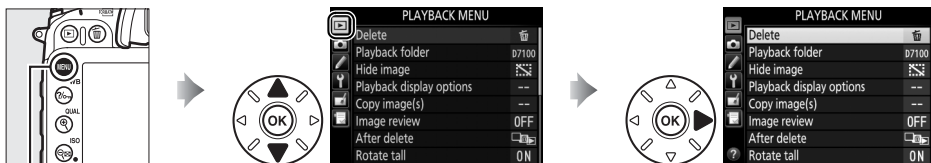

MENU button

The playback menu contains the following options:

Option	📖	Option	📖
Delete	198	Image review	222
Playback folder	217	After delete	222
Hide image	218	Rotate tall	222
Playback display options	219	Slide show	223
Copy image(s)	219	DPOF print order	213

🔗 See Also

Menu defaults are listed on page 324.

Playback Folder

MENU button → ▶ playback menu

Choose a folder for playback (📖 185):

Option	Description
D7100	Pictures in all folders created with the D7100 will be visible during playback.
All	Pictures in all folders will be visible during playback.
Current	Only pictures in the current folder will be visible during playback.

Hide Image

MENU button → playback menu

Hide or reveal pictures. Hidden pictures are visible only in the **Hide image** menu and can only be deleted by formatting the memory card.

Option	Description
Select/set	Hide or reveal selected pictures.
Select date	Selecting this option displays a list of dates. To hide all pictures taken on a date, highlight the date and press ▶ . Selected dates are marked by a ✓ ; to reveal all pictures taken on a selected date, highlight it and press ▶ . Press OK to complete the operation.
Deselect all?	Reveal all pictures.



Protected and Hidden Images

Revealing a protected image will also remove protection from the image.

Follow the steps below to hide or reveal selected pictures.

1 Choose **Select/set**.

Highlight **Select/set** and press **▶**.

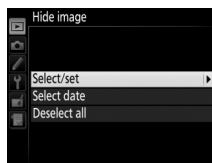

2 Select pictures.

Use the multi selector to scroll through the pictures on the memory card (to view the highlighted picture full screen, press and hold the **QUAL** button); to view images in other locations as described on page 186, hold **BKT** and press **▲**) and press **ISO** to select the current picture. Selected pictures are marked by a icon; to deselect a picture, highlight it and press **ISO** again. Continue until all the desired pictures have been selected.

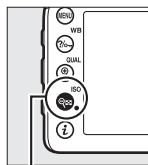

(ISO) button



3 Press **OK**.

Press **OK** to complete the operation.

Playback Display Options

MENU button →  playback menu

Choose the information available in the playback photo information display (☐ 187). Press ▲ or ▼ to highlight an option, then press ► to select the option for the photo information display. A ✓ appears next to selected items; to deselect, highlight and press ►. To return to the playback menu, press .



Copy Image(s)

MENU button →  playback menu

Copy pictures from one memory card to another. This option is only available when two memory cards are inserted in the camera.

Option	Description
Select source	Choose card from which pictures will be copied.
Select image(s)	Select pictures to be copied.
Select destination folder	Select destination folder on remaining card.
Copy image(s)?	Copy selected pictures to specified destination.

1 Choose Select source.

Highlight **Select source** and press ►.

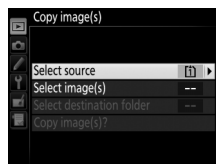

2 Select the source card.

Highlight the slot for the card containing the images to be copied and press .

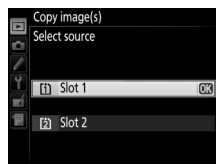

-
- 3 Choose Select image(s).**
Highlight **Select image(s)** and press ►.

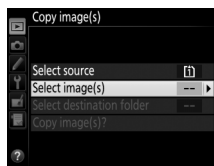

-
- 4 Select the source folder.**
Highlight the folder containing the images to be copied and press ►.

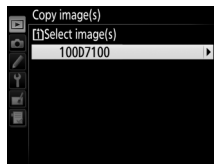

-
- 5 Make the initial selection.**
Before going on to select or deselect individual images, you can mark all or all protected images in the folder for copying by choosing **Select all images** or **Select protected images**. To mark only individually selected images for copying, choose **Deselect all** before proceeding.

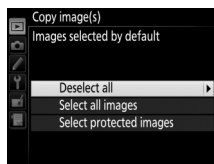

-
- 6 Select additional images.**
Highlight pictures and press **ISO** to select or deselect (to view the highlighted picture full screen, press and hold the **QUAL** button). Selected images are marked with a ✓. Press **OK** to proceed to Step 7 when your selection is complete.

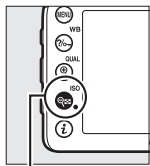

ISO button



-
- 7 Choose Select destination folder.**
Highlight **Select destination folder** and press ►.

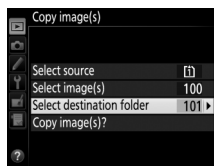

8 Select a destination folder.

To enter a folder number, choose **Select folder by number**, enter the number (□ 225), and press **OK**. If the folder with the selected number does not already exist, a new folder will be created.

To choose from a list of existing folders, choose **Select folder from list**, highlight a folder, and press **OK**.

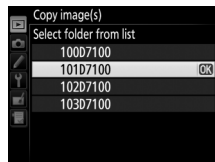

9 Copy the images.

Highlight **Copy image(s)?** and press **OK**.

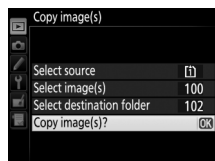

A confirmation dialog will be displayed; highlight **Yes** and press **OK**. Press **OK** again to exit when copying is complete.

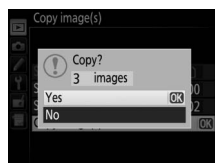

✓ Copying Images

Images will not be copied if there is insufficient space on the destination card. Be sure the battery is fully charged before copying movies.

If the destination folder contains an image with the same name as one of the images to be copied, a confirmation dialog will be displayed. Select **Replace existing image** to replace the image with the image to be copied, or select **Replace all** to replace all existing images with the same names without further prompting. To continue without replacing the image, select **Skip**, or select **Cancel** to exit without copying any further images.



Protect status is copied with the images but print marking (□ 213) is not. Hidden images can not be copied.



Image Review

MENU button →  playback menu



Choose whether pictures are automatically displayed in the monitor immediately after shooting. If **Off** is selected, pictures can only be displayed by pressing the  button.



After Delete

MENU button →  playback menu

Choose the picture displayed after an image is deleted.

Option	Description
 Show next	Display following picture. If deleted picture was last frame, previous picture will be displayed.
 Show previous	Display previous picture. If deleted picture was first frame, following picture will be displayed.
 Continue as before	If user was scrolling through pictures in order recorded, following picture will be displayed as described for Show next . If user was scrolling through pictures in reverse order, previous picture will be displayed as described for Show previous .

Rotate Tall

MENU button →  playback menu

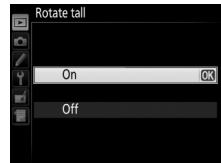

Choose whether to rotate “tall” (portrait-orientation) pictures for display during playback. Note that because the camera itself is already in the appropriate orientation during shooting, images are not rotated automatically during image review.



Option	Description
On	“Tall” (portrait-orientation) pictures are automatically rotated for display in the camera monitor. Pictures taken with Off selected for Auto image rotation ( 265) will be displayed in “wide” (landscape) orientation.
Off	“Tall” (portrait-orientation) pictures are displayed in “wide” (landscape) orientation.

Slide Show









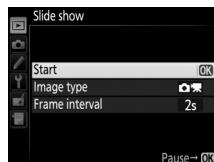



MENU button →  playback menu

Create a slide show of the pictures in the current playback folder ( 217). Hidden images ( 218) are not displayed.

Option	Description
Start	Start slide show.
Image type	Choose type of image displayed from Still images and movies , Still images only , and Movies only .
Frame interval	Choose how long each picture will be displayed.

To start the slide show, highlight **Start** and press . The following operations can be performed while the slide show is in progress:



To	Press	Description
Skip back/skip ahead		Press  to return to previous frame,  to skip to next frame.
View additional photo info		Change or hide photo info displayed (still images only;  187).
Pause/resume		Pause or resume slide show.
Raise/lower volume	 (QUAL) /  (ISO)	Press  (QUAL) during movie playback to increase volume,  (ISO) to decrease.
Exit to playback menu	MENU	End slide show and return to playback menu.
Exit to playback mode		End show and return to playback mode.
Exit to shooting mode		Press shutter-release button halfway to return to shooting mode.

The dialog shown at right is displayed when the show ends. Select **Restart** to restart or **Exit** to return to the playback menu.





The Shooting Menu: *Shooting Options*

To display the shooting menu, press **MENU** and select the  (shooting menu) tab.



MENU button

The shooting menu contains the following options:

Option		Option	
Reset shooting menu	224	Color space	227
Storage folder	225	Active D-Lighting	113
File naming	226	HDR (high dynamic range)	115
Role played by card in Slot 2	69	Auto distortion control	227
Image quality	66	Long exposure NR	228
Image size	68	High ISO NR	228
Image area	63	ISO sensitivity settings	79
JPEG compression	67	Remote control mode (ML-L3)	127
NEF (RAW) recording	67	Multiple exposure	141
White balance	89	Interval timer shooting	145
Set Picture Control	105	Movie settings	169
Manage Picture Control	110		

Note: Depending on camera settings, some items may be grayed out and unavailable. For information on the options available in each shooting mode, see page 321.

Reset Shooting Menu

MENU button →  shooting menu

Select **Yes** to restore shooting menu options to their default values ( 324).



Select the folder in which subsequent images will be stored.

■ Selecting Folders by Folder Number

1 Choose Select folder by number.

Highlight **Select folder by number** and press ►.
The dialog shown at right will be displayed.



2 Choose a folder number.

Press ◀ or ▶ to highlight a digit, press ▲ or ▼ to change. If a folder with the selected number already exists, a □, 📁, or 🖼️ icon will be displayed to the left of the folder number:

- □ : Folder is empty.
- 📁 : Folder is partially full.
- 🖼️ : Folder contains 999 pictures or a picture numbered 9999. No further pictures can be stored in this folder.

The card on which the folder is stored is shown by the card slot icon in the top right corner of the Select folder by number dialog. The card used for new folders depends on the option currently selected for **Role played by card in Slot 2** (📄 69).

3 Save changes and exit.

Press **OK** to complete the operation and return to the shooting menu (to exit without choosing the storage folder, press the **MENU** button). If a folder with the specified number does not already exist, a new folder will be created.

Subsequent photographs will be stored in the selected folder unless it is already full.

✔ Folder and File Numbers

If the current folder is numbered 999 and contains 999 pictures or a picture numbered 9999, the shutter-release will be disabled and no further photographs can be taken. To continue shooting, create a folder with a number less than 999, or select an existing folder with a number less than 999 and less than 999 images.

✎ Startup Time

Additional time may be required for camera startup if the memory card contains a very large number of files or folders.



■ ■ Selecting Folders from a List

1 Choose **Select folder from list**.

Highlight **Select folder from list** and press ►.



2 Highlight a folder.

Press ▲ or ▼ to highlight a folder.

3 Select the highlighted folder.

Press **OK** to select the highlighted folder and return to the shooting menu. Subsequent photographs will be stored in the selected folder.

File Naming

MENU button → shooting menu

Photographs are saved using file names consisting of “DSC_” or, in the case of images that use the Adobe RGB color space, “_DSC”, followed by a four-digit number and a three-letter extension (e.g., “DSC_0001.JPG”). The **File naming** option is used to select three letters to replace the “DSC” portion of the file name. For information on editing file names, see page 111.

Extensions

The following extensions are used: “.NEF” for NEF (RAW) images, “.JPG” for JPEG images, “.MOV” for movies, and “.NDF” for dust off reference data. In each pair of photographs recorded at image-quality settings of NEF (RAW) + JPEG, the NEF and JPEG images have the same file names but different extensions.



The color space determines the gamut of colors available for color reproduction. Choose **sRGB** for photographs that will be printed or used “as is,” with no further modification. **Adobe RGB** has a wider color gamut and is recommended for images that will be extensively processed or retouched after leaving the camera.

Color Space

Color spaces define the correspondence between colors and the numeric values that represent them in a digital image file. The sRGB color space is widely used, while the Adobe RGB color space is typically used in publishing and commercial printing. sRGB is recommended when taking photographs that will be printed without modification or viewed in applications that do not support color management, or when taking photographs that will be printed with ExifPrint, the direct printing option on some household printers, or kiosk printing or other commercial print services. Adobe RGB photographs can also be printed using these options, but colors will not be as vivid.

JPEG photographs taken in the Adobe RGB color space are DCF compliant; applications and printers that support DCF will select the correct color space automatically. If the application or device does not support DCF, select the appropriate color space manually. For more information, see the documentation provided with the application or device.

Nikon Software

ViewNX 2 (supplied) and Capture NX 2 (available separately) automatically select the correct color space when opening photographs created with this camera.

Auto Distortion Control

Select **On** to reduce barrel distortion when shooting with wide-angle lenses and to reduce pin-cushion distortion when shooting with long lenses (note that the edges of the area visible in the viewfinder may be cropped out of the final photograph, and that the time needed to process photographs before recording begins may increase). This option does not apply to movies and is available only with type G and D lenses (PC, fisheye, and certain other lenses excluded); results are not guaranteed with other lenses.

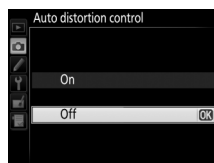

Retouch: Distortion Control

For information on creating copies of existing photographs with reduced barrel and pin-cushion distortion, see page 285.

Long Exposure NR (Long Exposure Noise Reduction)

MENU button →  shooting menu

If **On** is selected, photographs taken at shutter speeds slower than 1 s will be processed to reduce noise (bright spots, randomly-spaced bright pixels, or fog). The time required for processing roughly doubles; during processing, “**Job nr**” will flash in the shutter speed/aperture displays and pictures can not be taken (if the camera is turned off before processing is complete, the picture will be saved but noise reduction will not be performed). In continuous release mode, frame rates will slow and while photographs are being processed, the capacity of the memory buffer will drop. Long exposure noise reduction is not available during movie recording.

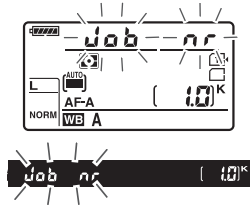

High ISO NR

MENU button →  shooting menu

Photographs taken at high ISO sensitivities can be processed to reduce “noise.”

Option	Description
High	Reduce noise (randomly-spaced bright pixels, lines, or fog), particularly in photographs taken at high ISO sensitivities. Choose the amount of noise reduction performed from High , Normal , and Low .
Normal	
Low	
Off	Noise reduction is only performed at ISO sensitivities of ISO 1250 and higher. The amount of noise reduction is less than the amount performed when Low is selected for High ISO NR .

Custom Settings: Fine-Tuning Camera Settings

To display the Custom Settings menu, press **MENU** and select the  (Custom Settings menu) tab.

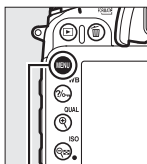

MENU button

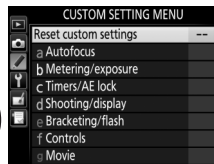
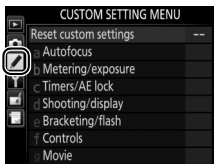

Custom Settings are used to customize camera settings to suit individual preferences.

Custom Setting groups

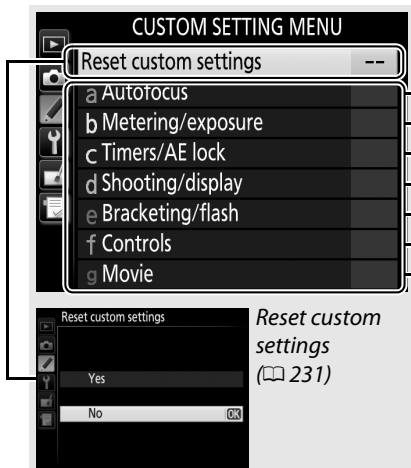

Main menu



Reset custom settings
 231



The following Custom Settings are available:

Custom Setting			Custom Setting		
Reset custom settings		231	d Shooting/display		
a Autofocus			d9	LCD illumination	241
a1	AF-C priority selection	231	d10	Exposure delay mode	241
a2	AF-S priority selection	231	d11	Flash warning	241
a3	Focus tracking with lock-on	232	d12	MB-D15 battery type	242
a4	AF point illumination	232	d13	Battery order	243
a5	Focus point wrap-around	232	e Bracketing/flash		
a6	Number of focus points	233	e1	Flash sync speed	244
a7	Built-in AF-assist illuminator	233	e2	Flash shutter speed	245
b Metering/exposure			e3	Flash cntrl for built-in flash	246
b1	ISO sensitivity step value	234	e4	Exposure comp. for flash	250
b2	EV steps for exposure cntrl	234	e5	Modeling flash	251
b3	Easy exposure compensation	235	e6	Auto bracketing set	251
b4	Center-weighted area	236	e7	Bracketing order	251
b5	Fine-tune optimal exposure	236	f Controls		
c Timers/AE lock			f1	OK button	252
c1	Shutter-release button AE-L	236	f2	Assign Fn button	253
c2	Standby timer	237	f3	Assign preview button	255
c3	Self-timer	237	f4	Assign AE-L/AF-L button	256
c4	Monitor off delay	238	f5	Customize command dials	257
c5	Remote on duration (ML-L3)	238	f6	Release button to use dial	258
d Shooting/display			f7	Slot empty release lock	258
d1	Beep	238	f8	Reverse indicators	258
d2	Viewfinder grid display	239	f9	Assign MB-D15  button	259
d3	ISO display and adjustment	239	g Movie		
d4	Screen tips	239	g1	Assign Fn button	259
d5	CL mode shooting speed	239	g2	Assign preview button	260
d6	Max. continuous release	240	g3	Assign AE-L/AF-L button	260
d7	File number sequence	240	g4	Assign shutter button	260
d8	Information display	241			

Note: Depending on camera settings, some items may be grayed out and unavailable. For information on the options available in each shooting mode, see page 321. If settings in the current bank have been modified from default values ( 325), an asterisk will be displayed adjacent to the altered settings in the second level of the Custom Settings menu.



Reset Custom Settings

MENU button →  Custom Settings menu

Select **Yes** to restore Custom Settings to their default values (📖 325).

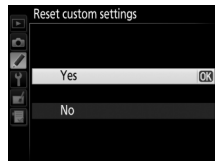



a: Autofocus

a1: AF-C Priority Selection

MENU button →  Custom Settings menu

When **AF-C** is selected for viewfinder photography (📖 71), this option controls whether photographs can be taken whenever the shutter-release button is pressed (*release priority*) or only when the camera is in focus (*focus priority*).



Option	Description
 Release	Photos can be taken whenever the shutter-release button is pressed.
 Focus	Photos can only be taken when the in-focus indicator (●) is displayed.

Regardless of the option selected, focus will not lock when **AF-C** is selected for autofocus mode. The camera will continue to adjust focus until the shutter is released.

a2: AF-S Priority Selection

MENU button →  Custom Settings menu

When **AF-S** is selected for viewfinder photography (📖 71), this option controls whether photographs can be taken only when the camera is in focus (*focus priority*) or whenever the shutter-release button is pressed (*release priority*).

Option	Description
 Release	Photos can be taken whenever the shutter-release button is pressed.
 Focus	Photos can only be taken when the in-focus indicator (●) is displayed.





Regardless of the option selected, if the in-focus indicator (●) is displayed when **AF-S** is selected for autofocus mode, focus will lock while the shutter-release button is pressed halfway. Focus lock continues until the shutter is released.



a3: Focus Tracking with Lock-On

MENU button →  Custom Settings menu

This option controls how autofocus adjusts to sudden large changes in the distance to the subject when **AF-C** is selected or continuous-servo autofocus is selected when the camera is in **AF-A** mode for viewfinder photography ( 71).

Option	Description
AF  5 (Long)	When the distance to the subject changes abruptly, the camera waits for the specified period before adjusting the distance to the subject. This prevents the camera from refocusing when the subject is briefly obscured by objects passing through the frame.
AF  4	
AF  3 (Normal)	
AF  2	
AF  1 (Short)	The camera immediately adjusts focus when the distance to the subject changes. Use when photographing a series of subjects at varying distances in quick succession.
Off	

a4: AF Point Illumination

MENU button →  Custom Settings menu



Choose whether the active focus point is highlighted in red in the viewfinder.

Option	Description
Auto	The selected focus point is automatically highlighted as needed to establish contrast with the background.
On	The selected focus point is always highlighted, regardless of the brightness of the background. Depending on the brightness of the background, the selected focus point may be difficult to see.
Off	The selected focus point is not highlighted.

a5: Focus Point Wrap-Around

MENU button →  Custom Settings menu

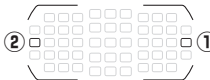
Choose whether focus-point selection “wraps around” from one edge of the display to another.

Option	Description
Wrap	Focus-point selection “wraps around” from top to bottom, bottom to top, right to left, and left to right, so that, for example, pressing  when a focus point at the right edge of the display is highlighted (①) selects the corresponding focus point at the left edge of the display (②). 
No wrap	The focus-point display is bounded by the outermost focus points so that, for example, pressing  when a focus point at the right edge of the display is selected has no effect.

a6: Number of Focus Points

MENU button →  Custom Settings menu

Choose the number of focus points available for manual focus-point selection.

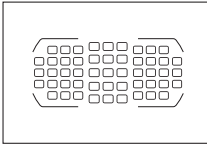
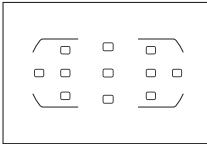
Option	Description	
AF51 51 points	Choose from the 51 focus points shown at right.	
AF11 11 points	Choose from the 11 focus points shown at right. Use for quick focus-point selection.	

a7: Built-in AF-assist Illuminator

MENU button →  Custom Settings menu

Choose whether the built-in AF-assist illuminator lights to assist the focus operation when lighting is poor.

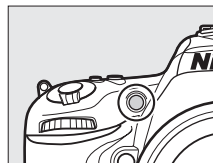

Option	Description
On	The AF-assist illuminator lights when lighting is poor (viewfinder photography only). AF-assist illumination is only available when both of the following conditions are met: <ol style="list-style-type: none">1. AF-S is selected for autofocus mode (□ 71) or single-servo autofocus is selected when the camera is in AF-A mode.2. Auto-area AF is chosen for AF-area mode (□ 73), or single-point or dynamic-area AF is chosen and the center focus point is selected.
Off	The AF-assist illuminator does not light to assist the focus operation. The camera may not be able to focus using autofocus when lighting is poor.

The AF-Assist Illuminator

Remove lens hoods when using the AF-assist illuminator.

See Also

For information on the shooting modes in which AF-assist is available, see page 321. See page 301 for restrictions on the lenses that can be used with AF assist.



b: Metering/Exposure

b1: ISO Sensitivity Step Value

MENU button →  Custom Settings menu

Select the increments used when making adjustments to ISO sensitivity. If possible, the current ISO sensitivity setting is maintained when the step value is changed. If the current setting is not available at the new step value, ISO sensitivity will be rounded to the nearest available setting.

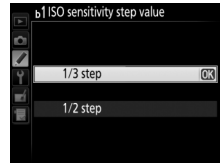

b2: EV Steps for Exposure Cntrl

MENU button →  Custom Settings menu

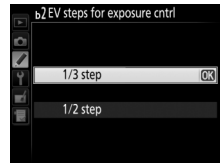

Select the increments used when making adjustments to shutter speed, aperture, exposure and flash compensation, and bracketing.



b3: Easy Exposure Compensation

MENU button →  Custom Settings menu

This option controls whether the  button is needed to set exposure compensation (□ 86). If **On (Auto reset)** or **On** is selected, the 0 at the center of the exposure display will flash even when exposure compensation is set to ± 0 .

Option	Description
On (Auto reset)	Exposure compensation is set by rotating one of the command dials (see note below). The setting selected using the command dial is reset when the camera turns off or the standby timer expires (exposure compensation settings selected using the  button are not reset).
On	As above, except that the exposure compensation value selected using the command dial is not reset when the camera turns off or the standby timer expires.
Off	Exposure compensation is set by pressing the  button and rotating the main command dial.

Change Main/Sub

The dial used to set exposure compensation when **On (Auto reset)** or **On** is selected for Custom Setting b3 (**Easy exposure compensation**) depends on the option selected for Custom Setting f5 (**Customize command dials**) > **Change main/sub** (□ 257).

Customize command dials > Change main/sub			
	Off	On	
Mode	P	Sub-command dial	Sub-command dial
	S	Sub-command dial	Main command dial
	A	Main command dial	Sub-command dial
	M	N/A	

Show ISO/Easy ISO

Custom Setting b3 (**Easy exposure compensation**) can not be used with Custom Setting d3 (**ISO display and adjustment**) > **Show ISO/Easy ISO**. Adjustments to either of these items reset the remaining item; a message is displayed when the item is reset.



b4: Center-Weighted Area

MENU button →  Custom Settings menu

When calculating exposure, center-weighted metering assigns the greatest weight to a circle in the center of the frame. The diameter (ϕ) of this circle can be set to 6, 8, 10, or 13 mm or to the average of the entire frame.

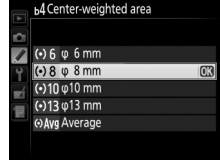

Note that the diameter is fixed at 8 mm when a non-CPU lens is used, regardless of the setting selected for **Non-CPU lens data** in the setup menu (□ 149). When **Average** is selected, the average of the entire frame will be used for CPU lenses.

b5: Fine-tune Optimal Exposure

MENU button →  Custom Settings menu

Use this option to fine-tune the exposure value selected by the camera. Exposure can be fine-tuned separately for each metering method by from +1 to -1 EV in steps of $\frac{1}{6}$ EV.

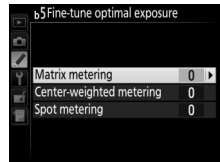

Fine-Tuning Exposure

Exposure fine-tuning is not affected by two-button resets. Note that as the exposure compensation () icon is not displayed, the only way to determine how much exposure has been altered is to view the amount in the fine-tuning menu. Exposure compensation (□ 86) is preferred in most situations.

c: Timers/AE Lock

c1: Shutter-Release Button AE-L

MENU button →  Custom Settings menu

If **On** is selected, exposure will lock when the shutter-release button is pressed halfway.

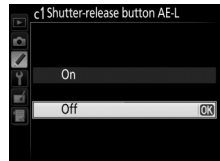

c2: Standby timer

MENU button →  Custom Settings menu

Choose how long the camera continues to meter exposure when no operations are performed. The shutter-speed and aperture displays in the control panel and viewfinder turn off automatically when the timer expires.

Choose a shorter standby timer delay for longer battery life.



c3: Self-Timer

MENU button →  Custom Settings menu

Choose the length of the shutter release delay, the number of shots taken, and the interval between shots in self-timer mode (📖 59).

- **Self-timer delay:** Choose the length of the shutter-release delay.
- **Number of shots:** Press ▲ and ▼ to choose the number of shots taken each time the shutter-release button is pressed.
- **Interval between shots:** Choose the interval between shots when the **Number of shots** is more than 1.

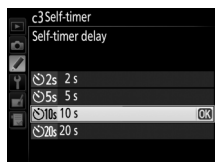
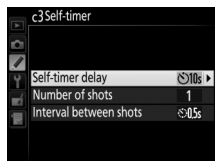

c4: Monitor off Delay

MENU button →  Custom Settings menu

Choose how long the monitor remains on when no operations are performed during playback (**Playback**; defaults to 10 s) and image review (**Image review**; defaults to 4 s), when menus (**Menus**; defaults to 1 minute) or information (**Information display**; defaults to 10 s) are displayed, or during live view and movie recording (**Live view**; defaults to 10 minutes). Choose a shorter monitor-off delay for longer battery life.

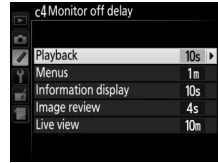

c5: Remote on Duration (ML-L3)

MENU button →  Custom Settings menu

Choose how long the camera will remain on stand-by in remote control mode (☞ 127). If no operations are performed for the selected period, remote shooting will end and **Off** will automatically be selected for **Remote control mode (ML-L3)** in the shooting menu. Choose shorter times for longer battery life.

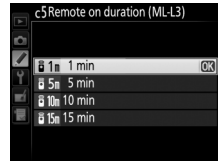

d: Shooting/Display

d1: Beep

MENU button →  Custom Settings menu

Choose the pitch and volume of the beep that sounds when the camera focuses using single-servo AF (**AF-S** or when single-servo AF is selected for **AF-A**; ☞ 71), when focus locks during live view photography, while the release timer is counting down in self-timer (☞ 59) and delayed remote modes (☞ 127), when a photograph is taken in quick-response remote or remote mirror-up mode (☞ 127), or if you attempt to take a photograph when the memory card is locked (☞ 31). Note that a beep will not sound in movie live view (☞ 161) or quiet-shutter release mode (mode **Q**; ☞ 57), regardless of the option selected.

- **Volume:** Choose **3** (high), **2** (medium), **1** (low) or **Off** (mute).
When an option other than **Off** is selected,  appears in the information display.
- **Pitch:** Choose **High** or **Low**.

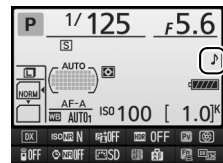

d2: Viewfinder Grid Display

MENU button →  Custom Settings menu

Choose **On** to display on-demand grid lines in the viewfinder (📖 9) for reference when composing photographs using the DX-format image area (📖 63).

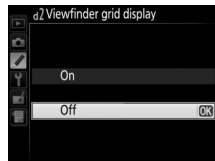

d3: ISO Display and Adjustment

MENU button →  Custom Settings menu

If **Show ISO sensitivity** or **Show ISO/Easy ISO** is selected, the control panel will show ISO sensitivity in place of the number of exposures remaining. If **Show ISO/Easy ISO** is selected, ISO sensitivity can be set in modes **P** and **S** by rotating the sub-command dial or in mode **A** by rotating the main command dial. Select **Show frame count** to display the number of exposures remaining in the control panel.

d4: Screen Tips

MENU button →  Custom Settings menu

Choose **On** to display tool tips for items selected in the information display (📖 12).

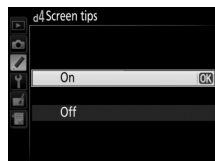

d5: CL Mode Shooting Speed

MENU button →  Custom Settings menu

Choose the maximum frame advance rate in **CL** (continuous low speed) mode (📖 57; during interval timer photography, this setting also determines the frame advance rate for single-frame).

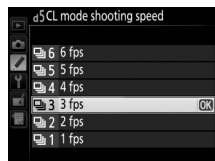

d6: Max. Continuous Release

MENU button →  Custom Settings menu

The maximum number of shots that can be taken in a single burst in continuous mode can be set to any value between 1 and 100.

The Memory Buffer

Regardless of the option selected for Custom Setting d6, shooting will slow when the memory buffer fills (P00). See page 348 for more information on the capacity of the memory buffer.

d7: File Number Sequence

MENU button →  Custom Settings menu

When a photograph is taken, the camera names the file by adding one to the last file number used. This option controls whether file numbering continues from the last number used when a new folder is created, the memory card is formatted, or a new memory card is inserted in the camera.

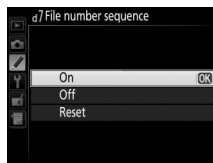

Option	Description
On	When a new folder is created, the memory card formatted, or a new memory card inserted in the camera, file numbering continues from the last number used or from the largest file number in the current folder, whichever is higher. If a photograph is taken when the current folder contains a photograph numbered 9999, a new folder will be created automatically and file numbering will begin again from 0001.
Off	File numbering is reset to 0001 when a new folder is created, the memory card is formatted, or a new memory card is inserted in the camera. Note that a new folder is created automatically if a photograph is taken when the current folder contains 999 photographs.
Reset	As for On , except that the next photograph taken is assigned a file number by adding one to the largest file number in the current folder. If the folder is empty, file numbering is reset to 0001.

File Number Sequence

If the current folder is numbered 999 and contains either 999 photographs or a photograph numbered 9999, the shutter-release button will be disabled and no further photographs can be taken. Choose **Reset** for Custom Setting d7 (**File number sequence**) and then either format the current memory card or insert a new memory card.

d8: Information Display

MENU button →  Custom Settings menu

If **Auto** (AUTO) is selected, the color of the lettering in the information display (□ 10) will automatically change from black to white or white to black to maintain contrast with the background. To always use the same color lettering, select **Manual** and choose **Dark on light** (B; black lettering) or **Light on dark** (W; white lettering). Monitor brightness will automatically be adjusted for maximum contrast with the selected text color.

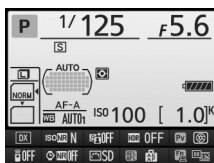

Dark on light



Light on dark

d9: LCD Illumination

MENU button →  Custom Settings menu

If **Off** is selected, the control panel backlight (LCD illuminator) will only light while the power switch is rotated toward . If **On** is selected, the control panel will be illuminated whenever the standby timer is active (□ 38). Select **Off** for increased battery life.

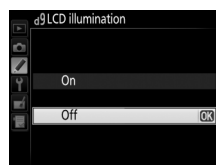

d10: Exposure Delay Mode

MENU button →  Custom Settings menu

In situations where the slightest camera movement can blur pictures, select **1 s**, **2 s**, or **3 s** to delay shutter release until one, two, or three seconds after the mirror is raised.

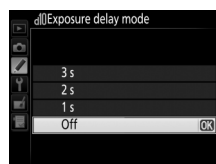

d11: Flash Warning



MENU button →  Custom Settings menu

If **On** is selected, the flash-ready indicator () will flash in the viewfinder if the flash is required to ensure optimal exposure.

d12: MB-D15 Battery Type





MENU button →  Custom Settings menu

To ensure that the camera functions as expected when the optional MB-D15 battery pack is used with AA batteries, match the option selected in this menu to the type of batteries inserted in the battery pack. There is no need to adjust this option when using EN-EL15 batteries.

Option	Description
 LR6 (AA alkaline)	Select when using LR6 alkaline AA batteries.
 HR6 (AA Ni-MH)	Select when using HR6 Ni-MH AA batteries.
 FR6 (AA lithium)	Select when using FR6 lithium AA batteries.

Using AA Batteries

The capacity of AA batteries drops sharply at temperatures below 20 °C (68 °F) and varies with make and storage conditions; in some cases, batteries may cease to function before their expiry date. Some AA batteries can not be used; due to their performance characteristics and limited capacity, alkaline batteries have less capacity than some other types and should only be used if no alternative is available and then only at warmer temperatures. The camera shows the level of AA batteries as follows:

Control panel	Viewfinder	Description
	—	Batteries fully charged.
		Low battery. Ready fresh batteries.
 (flashes)	 (flashes)	Shutter release disabled. Change batteries.

d13: Battery Order

MENU button →  Custom Settings menu

Choose whether the battery in the camera or the batteries in the battery pack are used first when an optional MB-D15 battery pack is attached. Note that if the MB-D15 is powered by an optional EH-5b AC adapter and EP-5B power connector, the AC adapter will be used regardless of the option selected.



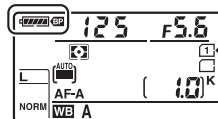

A  icon is displayed in the camera control panel when the batteries in the MB-D15 are in use.



The MB-D15 Battery Pack

The MB-D15 takes one EN-EL15 rechargeable Li-ion battery or six AA alkaline, Ni-MH, or lithium batteries (an EN-EL15 is supplied with the camera; AA batteries are available separately).

The information display shows the type of battery inserted in the MB-D15 as follows:

MB-D15 battery type display	Battery type
	EN-EL15 rechargeable Li-ion battery
	AA batteries

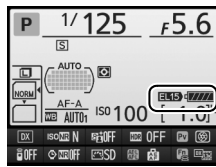

e: Bracketing/Flash

e1: Flash Sync Speed

MENU button →  Custom Settings menu

This option controls flash sync speed.

Option	Description
1/320 s (Auto FP)	Auto FP high-speed sync is used when a compatible flash unit is attached (☞ 305). If the built-in flash or other flash units are used, shutter speed is set to $1/320$ s. When the camera shows a shutter speed of $1/320$ s in mode P or A , auto FP high-speed sync will be activated if the actual shutter speed is faster than $1/320$ s.
1/250 s (Auto FP)	Auto FP high-speed sync is used when a compatible flash unit is attached (☞ 305). If the built-in flash or other flash units are used, shutter speed is set to $1/250$ s. When the camera shows a shutter speed of $1/250$ s in mode P or A , auto FP high-speed sync will be activated if the actual shutter speed is faster than $1/250$ s.
1/250 s–1/60 s	Flash sync speed set to selected value.

Fixing Shutter Speed at the Flash Sync Speed Limit

To fix shutter speed at the sync speed limit in mode **S** or **M**, select the next shutter speed after the slowest possible shutter speed (30 s or Time/- -). An X (flash sync indicator) will be displayed in the viewfinder and control panel.

Auto FP High-Speed Sync

Allows the flash to be used at the highest shutter speed supported by the camera, making it possible to choose the maximum aperture for reduced depth of field even when the subject is backlit in bright sunlight. The information display flash mode indicator shows “FP” when auto FP high-speed sync is active (☞ 306).

■ Auto FP High-Speed Sync

When **1/320 s (Auto FP)** or **1/250 s (Auto FP)** is selected for Custom Setting e1 (**Flash sync speed**, □ 244), the built-in flash can be used at shutter speeds as fast as $1/320$ s or $1/250$ s, while compatible optional flash units (□ 305) can be used at any shutter speed (Auto FP High-Speed Sync).

Flash sync speed / Shutter speed	1/320 s (Auto FP)		1/250 s (Auto FP)		1/250 s	
	Built-in flash	Optional flash unit	Built-in flash	Optional flash unit	Built-in flash	Optional flash unit
From $1/8000$ to but not including $1/320$ s	—	Auto FP	—	Auto FP	—	—
From $1/320$ to but not including $1/250$ s	Flash sync *		—	Auto FP	—	—
$1/250$ –30 s	Flash sync					

* Flash range drops as shutter speed increases. Flash range will nevertheless be greater than that obtained at the same speeds with Auto FP.

e2: Flash Shutter Speed

MENU button →  Custom Settings menu

This option determines the slowest shutter speed available when using front- or rear-curtain sync or red-eye reduction in mode **P** or **A** (regardless of the setting chosen, shutter speeds can be as slow as 30 s in **S** and **M** modes or at flash settings of slow sync, slow rear-curtain sync, or red-eye reduction with slow sync). Options range from $1/60$ s (**1/60 s**) to 30 s (**30 s**).

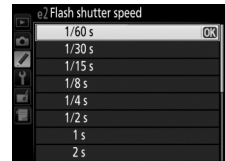

e3: Flash Cntrl for Built-in Flash

MENU button → Custom Settings menu

Choose the flash mode for the built-in flash.

Option	Description
TTL	Flash output is adjusted automatically in response to shooting conditions.
Manual	Choose the flash level (246). The camera does not emit monitor pre-flashes.
RPT Repeating flash	The flash fires repeatedly while the shutter is open, producing a strobe-light effect (246).
CMD Commander mode	Use the built-in flash as a master flash controlling remote optional flash units in one or more groups (247).

Manual

Choose a flash level between **Full** and **1/128** ($1/128$ of full power). At full power, the built-in flash has a Guide Number of 12/39 (m/ft, ISO 100, 20 °C/68 °F).

Repeating Flash

The flash fires repeatedly while the shutter is open, producing a strobe-light effect. Press ◀ or ▶ to highlight the following options, ▲ or ▼ to change.

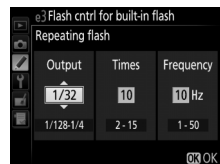

Option	Description
Output	Choose flash output (expressed as a fraction of full power).
Times	Choose the number of times the flash fires at the selected output. Note that depending on shutter speed and the option selected for Frequency , the actual number of flashes may be less than selected.
Frequency	Choose how often the flash fires per second.

Flash Control Mode

The flash control mode for the built-in flash is shown in the information display (122).

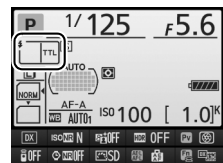

“Manual” and “Repeating Flash”

icons flash in the control panel and viewfinder when these options are selected.

The SB-400

When an optional SB-400 flash unit is attached and turned on, Custom Setting e3 changes to **Optional flash**, allowing the flash control mode for the SB-400 to be selected from **TTL** and **Manual** (**Repeating flash** and **Commander mode** options are not available).





"Times"

The options available for **Repeating flash** > **Times** are determined by flash output.

Output	Options available for "Times"	Output	Options available for "Times"
1/4	2	1/32	2–10, 15
1/8	2–5	1/64	2–10, 15, 20, 25
1/16	2–10	1/128	2–10, 15, 20, 25, 30, 35

Commander Mode

Use the built-in flash as a master flash controlling one or more remote optional flash units in up to two groups (A and B) using advanced wireless lighting ( 305).

Selecting this option displays the menu shown at right. Press  or  to highlight the following options,  or  to change.

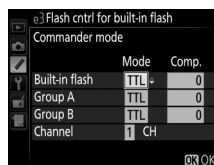

Option	Description
Built-in flash	Choose a flash mode for the built-in flash (commander flash).
TTL	i-TTL mode. Choose flash compensation from values between +3.0 and –3.0 EV in increments of 1/3 EV.
M	Choose the flash level from values between 1/1 and 1/128 (1/128 of full power).
--	The built-in flash does not fire, although remote flash units do. The built-in flash must be raised so that it can emit monitor pre-flashes.
Group A	Choose a flash mode for all flash units in group A.
TTL	i-TTL mode. Choose flash compensation from values between +3.0 and –3.0 EV in increments of 1/3 EV.
AA	Auto aperture (available only with compatible flash units;  305). Choose flash compensation from values between +3.0 and –3.0 EV in increments of 1/3 EV.
M	Choose the flash level from values between 1/1 and 1/128 (1/128 of full power).
--	The flash units in this group do not fire.
Group B	Choose a flash mode for all flash units in group B. The options available are the same as those listed for Group A , above.
Channel	Choose from channels 1–4. All flash units in both groups must be set to the same channel.



Follow the steps below to take photographs in commander mode.

1 Adjust settings for the built-in flash.

Choose the flash control mode and output level for the built-in flash. Note that output level can not be adjusted in -- mode.

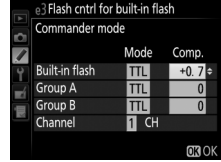

2 Adjust settings for group A.

Choose the flash control mode and output level for the flash units in group A.

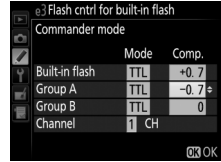

3 Adjust settings for group B.

Choose the flash control mode and output level for the flash units in group B.

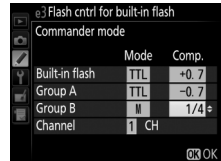

4 Select the channel.

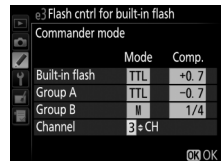

5 Press **OK**.



6 Compose the shot.

Compose the shot and arrange the flash units as shown below. Note that the maximum distance at which the remote flash units can be placed may vary with shooting conditions.

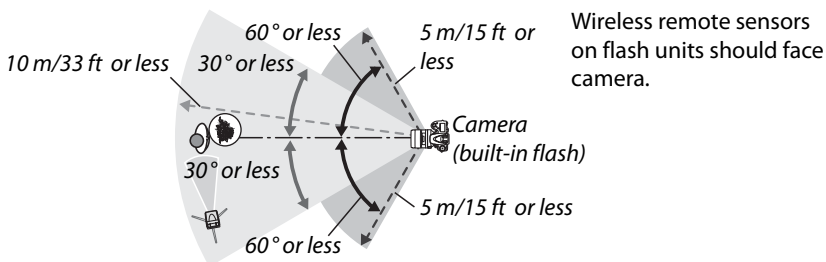

7 Configure the remote flash units.

Turn all the remote flash units on, adjust group settings as desired, and set them to the channel selected in Step 4. See the flash unit instruction manuals for details.

8 Raise the built-in flash.

Press the  button to raise the built-in flash. Note that even if -- is selected for **Built-in flash > Mode**, the built-in flash must be raised so that monitor preflashes will be emitted.





9 Frame the photograph, focus, and shoot.

After confirming that the camera flash-ready light and the flash-ready lights for all other flash units are lit, frame the photograph, focus, and shoot. FV lock ( 125) can be used if desired.

The Flash Sync Mode Display

 does not appear in the control panel flash sync mode display when -- is selected for **Built-in flash > Mode**.

Flash Compensation

The flash compensation value selected with the  () button and sub-command dial is added to the flash compensation values selected for the built-in flash, group A, and group B in the **Commander mode** menu. A  icon is displayed in the control panel and viewfinder when a flash compensation value other than ± 0 is selected for **Built-in flash > TTL**. The  icon flashes when the built-in flash is in mode **M**.

Commander Mode



Position the sensor windows on the remote flash units to pick up the light from the built-in flash (particular care is required if the camera is not mounted on a tripod). Be sure that direct light or strong reflections from the remote flash units do not enter the camera lens (in TTL mode) or the photocells on the remote flash units (AA mode), as this may interfere with exposure. To prevent timing flashes emitted by the built-in flash from appearing in photographs taken at short range, choose low ISO sensitivities or small apertures (high f-numbers) or use an optional SG-3IR infrared panel for the built-in flash. An SG-3IR is required for best results with rear-curtain sync, which produces brighter timing flashes. After positioning the remote flash units, take a test shot and view the results in the camera monitor.

Although there is no limit on the number of remote flash units that may be used, the practical maximum is three. With more than this number, the light emitted by the remote flash units will interfere with performance.

e4: Exposure Comp. for Flash

MENU button →  Custom Settings menu

Choose how the camera adjusts flash level when exposure compensation is used.

Option	Description
 Entire frame	Both flash level and exposure compensation are adjusted to modify exposure over the entire frame.
 Background only	Exposure compensation applies to background only.

e5: Modeling Flash

MENU button →  Custom Settings menu

If **On** is selected when the camera is being used with the built-in flash or an optional CLS-compatible flash unit (☐ 305), a modeling flash will be emitted when the camera depth-of-field preview button is pressed (☐ 50). No modeling flash is emitted if **Off** is selected.

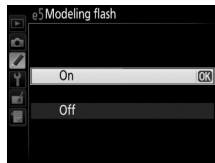

e6: Auto Bracketing Set

MENU button →  Custom Settings menu

Choose the setting or settings bracketed when auto bracketing (☐ 133) is in effect. Choose **AE & flash** (AE) to perform both exposure and flash-level bracketing, **AE only** (AE) to bracket only exposure, **Flash only** (f) to perform only flash-level bracketing, **WB bracketing** (WB) to perform white-balance bracketing (☐ 137), or **ADL bracketing** (ADL) to perform bracketing using Active D-Lighting (☐ 139). Note that white balance bracketing is not available at image quality settings of NEF (RAW) or NEF (RAW) + JPEG.

e7: Bracketing Order

MENU button →  Custom Settings menu



At the default setting of **MTR > under > over** (☐), exposure, flash, and white balance bracketing are performed in the order described on pages 133 and 137. If **Under > MTR > over** (→+) is selected, shooting will proceed in order from the lowest to the highest value. This setting has no effect on ADL bracketing.





f: Controls

f1: OK Button









MENU button →  Custom Settings menu

This option determines the role assigned to the  button during viewfinder photography, playback, and live view (regardless of the option selected, pressing  when a movie is displayed full frame starts movie playback).







■■ Shooting Mode

Option	Role assigned to  button
RESET  Select center focus point	Select center focus point.
 Highlight active focus point	Highlight the active focus point.
Not used	None.

■■ Playback Mode

Option	Role assigned to  button
 Thumbnail on/off	Toggle between full-frame and thumbnail playback.
 View histograms	In both full-frame and thumbnail playback, a histogram ( 189) is displayed while the  button is pressed.
 Zoom on/off	Toggle between full-frame or thumbnail playback and playback zoom. Choose the initial zoom setting from Low magnification , Medium magnification , and High magnification . The zoom display will center on the active focus point.
 Choose slot and folder	Display the slot and folder selection dialog ( 186).

■■ Live View





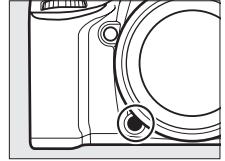







Option	Role assigned to  button
RESET  Select center focus point	Pressing the  button in live view selects the center focus point.
 Zoom on/off	Press the  button to toggle zoom on and off. Choose the initial zoom setting from Low magnification , Medium magnification , and High magnification . The zoom display will center on the active focus point.
Not used	Pressing the  button has no effect in live view.

Choose the role played by the **Fn** button, either by itself (**Press**) or when used in combination with the command dials (**Press + command dials**).









■ Press

Selecting **Press** displays the following options:

Option	Description
 Preview	Press the Fn button to preview depth of field (□ 50).
 FV lock	Press the Fn button to lock flash value (built-in flash and compatible optional flash units only, □ 125, 305). Press again to cancel FV lock.
 AE/AF lock	Focus and exposure lock while the Fn button is pressed.
 AE lock only	Exposure locks while the Fn button is pressed.
 AE lock (Hold)	Exposure locks when the Fn button is pressed, and remains locked until the button is pressed a second time or the standby timer expires.
 AF lock only	Focus locks while the Fn button is pressed.
 AF-ON	Pressing the Fn button initiates autofocus. The shutter-release button can not be used to focus.
 Flash off	The flash will not fire in photos taken while the Fn button is pressed.
 Bracketing burst	If the Fn button is pressed while exposure, flash, or ADL bracketing is active in single frame or quiet shutter-release mode, all shots in the current bracketing program will be taken each time the shutter-release button is pressed. If white balance bracketing is active or continuous release mode (mode CN or CL) is selected, the camera will repeat the bracketing burst while the shutter-release button is held down.
 + NEF (RAW)	If image quality is set to JPEG fine , JPEG normal , or JPEG basic , “RAW” will be displayed in the control panel and an NEF (RAW) copy will be recorded with the next picture taken after the Fn button is pressed (to record NEF/RAW copies with a series of photographs, keep the shutter-release button pressed halfway between shots). To exit without recording an NEF (RAW) copy, press the Fn button again.
 Matrix metering	Matrix metering is activated while the Fn button is pressed.
 Center-weighted metering	Center-weighted metering is activated while the Fn button is pressed.
 Spot metering	Spot metering is activated while the Fn button is pressed.





Option	Description
 Viewfinder grid display	If DX (24×16) is selected for Image area (☐ 63), the Fn button can be used to display or hide the framing grid in the viewfinder (☐ 239).
 Viewfinder virtual horizon	Press the Fn button to view a virtual horizon display in the viewfinder.
 MY MENU	Pressing the Fn button displays “MY MENU” (☐ 291).
 Access top item in MY MENU	Press the Fn button to jump to the top item in “MY MENU.” Select this option for quick access to a frequently-used menu item.
 Playback	Fn button performs same function as  button. Select when using a telephoto lens or in other circumstances in which it is difficult to operate the  button with your left hand.
None	Pressing the button has no effect.

Incompatible Options

If the option selected for **Press** can not be used in combination with the option selected for **Press + command dials**, a message will be displayed and whichever of **Press** or **Press + command dials** was selected first will be set to **None**.

Viewfinder Virtual Horizon

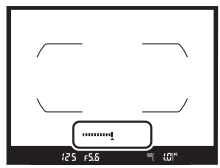
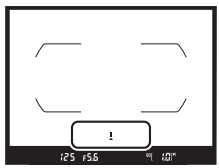
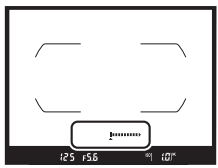

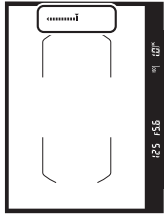
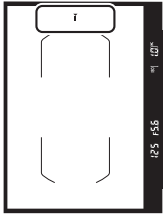
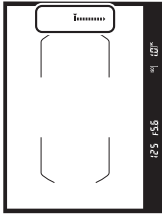
When **Viewfinder virtual horizon** is selected for Custom Setting f2 (**Assign Fn button**), pressing the **Fn** button displays a roll indicator in the viewfinder. Press the button again to restore the indicator to its normal function.

	Camera tilted right	Camera level	Camera tilted left
Viewfinder (camera in landscape orientation) 			
Viewfinder (camera in portrait orientation) 			

Note that the display may not be accurate when the camera is tilted at a sharp angle forward or back. To display a virtual horizon in the monitor, use the **Virtual horizon** option in the setup menu (☐ 269).

■ ■ Press + Command Dials

Selecting **Press + command dials** displays the following options:

Option	Description
 Choose image area	Press the Fn button and rotate a command dial to choose an image area (□ 63).
 1 step spd/aperture	If the Fn button is pressed when the command dials are rotated, changes to shutter speed (modes S and M) and aperture (modes A and M) are made in increments of 1 EV, regardless of the option selected for Custom Setting b2 (EV steps for exposure cntrl , □ 234).
Non-CPU Choose non-CPU lens number	Press the Fn button and rotate a command dial to choose a lens number specified using the Non-CPU lens data option (□ 149).
 Active D-Lighting	Press the Fn button and rotate a command dial to adjust Active D-Lighting (□ 113).
HDR HDR (high dynamic range)	Keeping the Fn button pressed, rotate the main command dial to choose an HDR mode , the sub-command dial to choose HDR strength (□ 116).
None	No operation is performed when the command dials are rotated while the Fn button is pressed.

f3: Assign Preview Button

MENU button →  Custom Settings menu

Choose the role played by the depth-of-field preview button, either by itself (**Press**) or when used in combination with the command dials (**Press + command dials**). The options available are the same as for **Assign Fn button** (□ 253). The default options for **Press** and **Press + command dials** are **Preview** and **None**, respectively.

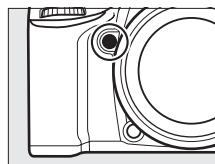

f4: Assign AE-L/AF-L Button





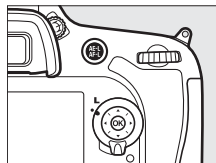







MENU button →  Custom Settings menu

Choose the role played by the  **AE-L/AF-L** button, either by itself (**Press**) or when used in combination with the command dials (**Press + command dials**).









■ ■ Press

Selecting **Press** displays the following options:

Option	Description
 AE/AF lock	Focus and exposure lock while the  AE-L/AF-L button is pressed.
 AE lock only	Exposure locks while the  AE-L/AF-L button is pressed.
 AE lock (Hold)	Exposure locks when the  AE-L/AF-L button is pressed, and remains locked until the button is pressed a second time or the standby timer expires.
 AF lock only	Focus locks while the  AE-L/AF-L button is pressed.
 AF-ON	The  AE-L/AF-L button initiates autofocus. The shutter-release button can not be used to focus.
 FV lock	Press the  AE-L/AF-L button to lock flash value (built-in flash and compatible optional flash units only,  125, 305). Press again to cancel FV lock.
None	Pressing the button has no effect.

■ ■ Press + Command Dials

Selecting **Press + command dials** displays the following options:





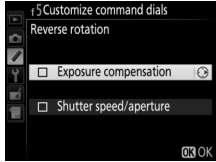
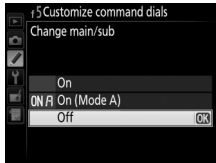



Option	Description
 Choose image area	Press the  AE-L/AF-L button and rotate a command dial to choose an image area ( 63).
Non-CPU Choose non-CPU lens number	Press the  AE-L/AF-L button and rotate a command dial to choose a lens number specified using the Non-CPU lens data option ( 149).
None	No operation is performed when the command dials are rotated while the  AE-L/AF-L button is pressed.

This option controls the operation of the main and sub-command dials.

- Reverse rotation:** Reverse the direction of rotation of the command dials when they are used to make adjustments to **Exposure compensation** and/or **Shutter speed/aperture**. Highlight options and press **▶** to select or deselect, then press **OK**. This setting also applies to the command dials for the MB-D15.
 
- Change main/sub:** If **Off** is selected, the main command dial controls shutter speed and the sub-command dial controls aperture. Select **On (Mode A)** to use the main command dial to select aperture in shooting mode **A**, **On** to use the main command dial to select aperture in modes **A** and **M** and the sub-command dial to select shutter speed in modes **S** and **M**. This setting also applies to the command dials for the MB-D15.
 
- Aperture setting:** If **Sub-command dial** is selected, aperture can only be adjusted with the sub-command dial (or with the main command dial if **On** is selected for **Change main/sub**). If **Aperture ring** is selected, aperture can only be adjusted with the lens aperture ring and the camera aperture display will show aperture in increments of 1 EV (aperture for type G lenses is still set using the sub-command dial). Note that regardless of the setting chosen, the aperture ring must be used to adjust aperture when a non-CPU lens is attached.
- Menus and playback:** If **Off** is selected, the multi selector is used to choose the picture displayed during full-frame playback, highlight thumbnails, and navigate menus. If **On** or **On (image review excluded)** is selected, the main command dial can be used to choose the picture displayed during full-frame playback, move the cursor left or right during thumbnail playback, and move the menu highlight bar up or down. The sub-command dial is used to display additional photo information in full-frame playback and to move the cursor up or down during thumbnail playback. Select **On (image review excluded)** to prevent the command dials from being used for playback during image review. While menus are displayed, rotating the sub-command dial right displays the sub-menu for the selected option, while rotating it left displays the previous menu. To make a selection, press **▶** or **OK**.

f6: Release Button to Use Dial

MENU button →  Custom Settings menu

If **Yes** is selected, adjustments that are normally made by rotating the command dial while holding a button can instead be made by rotating the command dial after the button is released (setting ends when the button is pressed again, the shutter-release button is pressed halfway, or the standby timer expires). The following buttons are affected: the , , , , , AF-mode, , or **BKT, Fn**, preview, and  **AE-L/AF-L** buttons. The **Fn** and preview buttons are only affected when assigned **Choose image area**, **Choose non-CPU lens number**, **Active D-Lighting**, or **HDR (high dynamic range)** using Custom Setting f2 (**Assign Fn button**) or f3 (**Assign preview button**). The  **AE-L/AF-L** button is only affected when assigned **Choose image area** or **Choose non-CPU lens number** using Custom Setting f4 (**Assign AE-L/AF-L button**). Note that the standby timer will not expire when **No limit** is selected for Custom Setting c2 (**Standby timer**).



f7: Slot Empty Release Lock

MENU button →  Custom Settings menu

Selecting **Enable release** allows the shutter to be released when no memory card is inserted, although no pictures will be recorded (they will however be displayed in the monitor in demo mode). If **Release locked** is selected, the shutter-release button is only enabled when a memory card is inserted in the camera.

f8: Reverse Indicators

MENU button →  Custom Settings menu









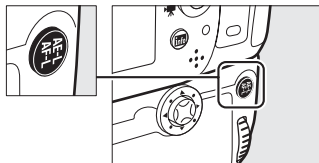







If  (-0+) is selected, the exposure indicators in the control panel, viewfinder, and information display are displayed with negative values on the left and positive values on the right. Select  (+0-) to display positive values on the left and negative values on the right.

f9: Assign MB-D15 Button

MENU button →  Custom Settings menu

Choose the function assigned to the  AE-L/AF-L button on the optional MB-D15 battery pack.









Option	Description
 AE/AF lock	Focus and exposure lock while the MB-D15  AE-L/AF-L button is pressed.
 AE lock only	Exposure locks while the MB-D15  AE-L/AF-L button is pressed.
 AE lock (Hold)	Exposure locks when the MB-D15  AE-L/AF-L button is pressed, and remains locked until the button is pressed a second time or the standby timer expires.
 AF lock only	Focus locks while the MB-D15  AE-L/AF-L button is pressed.
 AF-ON	Pressing the MB-D15  AE-L/AF-L button initiates autofocus. The shutter-release button can not be used to focus.
 FV lock	Press the MB-D15  AE-L/AF-L button to lock flash value (built-in flash and compatible optional flash units only,  125, 305). Press again to cancel FV lock.
 Same as Fn button	The MB-D15  AE-L/AF-L button performs the function selected for Custom Setting f2 ( 253).

g: Movie

g1: Assign Fn Button

MENU button →  Custom Settings menu

Choose the role played by the Fn button during movie live view (the default option is None).

Option	Description
 View photo shooting info	Press the button to display information on shutter speed, aperture, and other photo settings in place of movie recording information. Press again to return to the movie recording display ( 163).
 AE/AF lock	Focus and exposure lock while the button is pressed.
 AE lock only	Exposure locks while the button is pressed.
 AE lock (Hold)	Exposure locks when the button is pressed, and remains locked until the button is pressed a second time or the standby timer expires.
 AF lock only	Focus locks while the button is pressed.
 AF-ON	Pressing the button initiates autofocus. The shutter-release button can not be used to focus.
None	Pressing the button has no effect.



g2: Assign Preview Button

MENU button →  Custom Settings menu

Choose the role played by the depth-of-field preview button during movie live view. The options available are the same as for **Assign Fn button** (□ 259).

g3: Assign AE-L/AF-L Button



MENU button →  Custom Settings menu

Choose the role played by the ^{AE-L}/_{AF-L} AE-L/AF-L button during movie live view. The options available are the same as for **Assign Fn button** (□ 259), except that the default setting is **AE/AF lock**.



g4: Assign Shutter Button

MENU button →  Custom Settings menu

Choose the role played by pressing the shutter-release button when  is selected with the live view selector.

Option	Description
 Take photos	Press the shutter-release button all the way down to end movie recording and take a photograph with an aspect ratio of 16 : 9 (for information on image size, see page 167).
 Record movies	Press the shutter-release button halfway to start movie live view. You can then press the shutter-release button halfway to focus (autofocus mode only) and press it all the way down to start or end recording. To end movie live view, press the  button. The shutter-release button on an optional wireless remote controller or remote cord (□ 309, 310) can be used to start movie live view and to start and end movie recording; the optional ML-L3 remote control, however, can not be used to record movies; the shutter-release button on the ML-L3 has no effect.

Record Movies

If this option is selected, the shutter-release button can not be used for such functions as interval-timer photography or recording Image Dust Off reference data when the live view selector is rotated to , shooting information (□ 10) can not be displayed using the  button, and photo shooting info can not be displayed using buttons to which **View photo shooting info** (□ 259, 260) has been assigned using Custom Setting g1 (**Assign Fn button**), g2 (**Assign preview button**), or g3 (**Assign AE-L/AF-L button**). Select **Take photos** to use these functions.

Y The Setup Menu: *Camera Setup*

To display the setup menu, press **MENU** and select the **Y** (setup menu) tab.

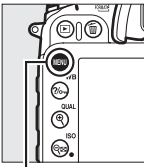

MENU button

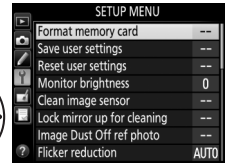
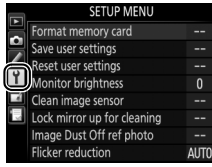

The setup menu contains the following options:

Option		Option	
Format memory card	262	Image comment	266
Save user settings	55	Copyright information	267
Reset user settings	56	Save/load settings	268
Monitor brightness	262	Virtual horizon	269
Clean image sensor	313	Non-CPU lens data	149
Lock mirror up for cleaning ¹	315	AF fine-tune	270
Image Dust Off ref photo	263	HDMI	216
Flicker reduction	264	GPS	152
Time zone and date	265	Wireless mobile adapter	271
Language	265	Network	206
Auto image rotation	265	Eye-Fi upload ²	272
Battery info	266	Firmware version	272

1 Not available when battery is low.

2 Only displayed when compatible Eye-Fi memory card is inserted (☞ 272).

See Also

Menu defaults are listed on page 326.



Format Memory Card

MENU button → Y setup menu

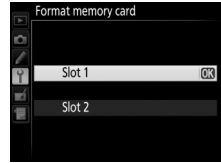

To begin formatting, choose a memory card slot and select **Yes**. *Note that formatting permanently deletes all pictures and other data on the card in the selected slot.* Before formatting, be sure to make backup copies as required.



✓ During Formatting

Do not turn the camera off or remove memory cards during formatting.

✍ Two-Button Format

Memory cards can also be formatted by pressing the  (FORMAT) and  (FORMAT) buttons for more than two seconds (☐ 32).

Monitor Brightness

MENU button → Y setup menu

Press ▲ or ▼ to choose monitor brightness for playback, menus, and the information display. Choose higher values for increased brightness, lower values for reduced brightness.

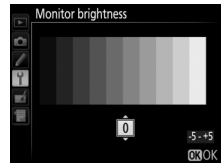

✍ Monitor Brightness

Values of +4 or higher make the monitor easier to read in bright light but also result in yellow colors taking on a greenish cast. Choose lower values for accurate color reproduction.

✍ See Also

For information on adjusting monitor brightness in live view, see page 157.

Acquire reference data for the Image Dust Off option in Capture NX 2 (available separately; for more information, see the Capture NX 2 manual).

Image Dust Off ref photo is available only when a CPU lens is mounted on the camera. A lens with a focal length of at least 50 mm is recommended. When using a zoom lens, zoom all the way in.

1 Choose a start option.

Highlight one of the following options and press . To exit without acquiring Image Dust Off reference data, press MENU.



- **Start:** The message shown at right will be displayed and “rEF” will appear in the viewfinder and control panel displays.
- **Clean sensor and then start:** Select this option to clean the image sensor before starting. The message shown at right will be displayed and “rEF” will appear in the viewfinder and control panel displays when cleaning is complete.



2 Frame a featureless white object in the viewfinder.

With the lens about ten centimeters (four inches) from a well-lit, featureless white object, frame the object so that it fills the viewfinder and then press the shutter-release button halfway.

In autofocus mode, focus will automatically be set to infinity; in manual focus mode, set focus to infinity manually.

3 Acquire dust off reference data.

Press the shutter-release button the rest of the way down to acquire Image Dust Off reference data. The monitor turns off when the shutter-release button is pressed. Note that noise reduction will be performed if the subject is poorly lit, increasing recording times.

If the reference object is too bright or too dark, the camera may be unable to acquire Image Dust Off reference data and the message shown at right will be displayed. Choose another reference object and repeat the process from Step 1.



✔ Image Sensor Cleaning

Dust off reference data recorded before image sensor cleaning is performed can not be used with photographs taken after image sensor cleaning is performed. Select **Clean sensor and then start** only if the dust off reference data will not be used with existing photographs.

✍ Image Dust Off Reference Data

The same reference data can be used for photographs taken with different lenses or at different apertures. Reference images can not be viewed using computer imaging software. A grid pattern is displayed when reference images are viewed on the camera.

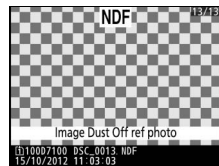

Flicker Reduction

MENU button →  setup menu

Reduce flicker and banding when shooting under fluorescent or mercury-vapor lighting during live view or movie recording. Choose **Auto** to allow the camera to automatically choose the correct frequency, or manually match the frequency to that of the local AC power supply.

✍ Flicker Reduction

If **Auto** fails to produce the desired results and you are unsure as to the frequency of the local power supply, test both the 50 and 60 Hz options and choose the one that produces the best results. Flicker reduction may not produce the desired results if the subject is very bright, in which case you should select mode **A** or **M** and choose a smaller aperture (higher f-number) before starting live view.

Time Zone and Date

MENU button →  setup menu

Change time zones, set the camera clock, choose the date display order, and turn daylight saving time on or off (□ 28).

Option	Description
Time zone	Choose a time zone. The camera clock is automatically set to the time in the new time zone.
Date and time	Set the camera clock. If the clock is not set, a flashing  icon will appear in the information display.
Date format	Choose the order in which the day, month, and year are displayed.
Daylight saving time	Turn daylight saving time on or off. The camera clock will automatically be advanced or set back one hour. The default setting is Off .

Language

MENU button →  setup menu

Choose a language for camera menus and messages.

Auto Image Rotation

MENU button →  setup menu

Photographs taken while **On** is selected contain information on camera orientation, allowing them to be rotated automatically during playback (□ 185) or when viewed in ViewNX 2 (supplied) or in Capture NX 2 (available separately; □ 309). The following orientations are recorded:



*Landscape (wide)
orientation*

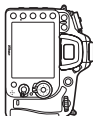

*Camera rotated 90°
clockwise*



*Camera rotated 90°
counter-clockwise*

Camera orientation is not recorded when **Off** is selected. Choose this option when panning or taking photographs with the lens pointing up or down.

Rotate Tall

To automatically rotate “tall” (portrait-orientation) photographs for display during playback, select **On** for the **Rotate tall** option in the playback menu (□ 222).



Battery Info

MENU button → Y setup menu

View information on the battery currently inserted in the camera.

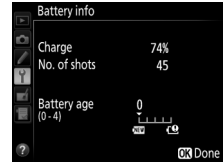

Item	Description
Charge	The current battery level expressed as a percentage.
No. of shots	The number of times the shutter has been released with the current battery since the battery was last charged. Note that the camera may sometimes release the shutter without recording a photograph, for example when measuring preset white balance.
Battery age	A five-level display showing battery age. 0 (NEW) indicates that battery performance is unimpaired, 4 (REPL) that the battery has reached the end of its charging life and should be replaced. Note that batteries charged at temperatures under about 5 °C (41 °F) may show a temporary drop in charging life; the battery age display will however return to normal once the battery has been recharged at a temperature of about 20 °C (68 °F) or higher.

The MB-D15 Battery Pack

The display for the MB-D15 battery pack is shown at right. If AA batteries are used, the battery level will be shown by a battery level icon; other items will not be displayed.

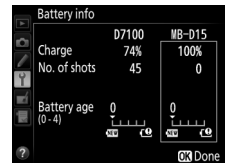
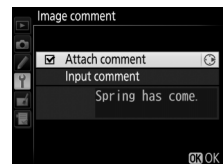

Image Comment

MENU button → Y setup menu

Add a comment to new photographs as they are taken. Comments can be viewed as metadata in ViewNX 2 (supplied) or Capture NX 2 (available separately; □ 309). The comment is also visible on the shooting data page in the photo information display (□ 190). The following options are available:

- **Input comment:** Input a comment as described on page 111. Comments can be up to 36 characters long.
- **Attach comment:** Select this option to attach the comment to all subsequent photographs. **Attach comment** can be turned on and off by highlighting it and pressing ►. After choosing the desired setting, press OK to exit.



Add copyright information to new photographs as they are taken. Copyright information is included in the shooting data shown in the photo information display (□ 190) and can be viewed as metadata in ViewNX 2 (supplied) or in Capture NX 2 (available separately; □ 309). The following options are available:

- **Artist:** Enter a photographer name as described on page 111. Photographer names can be up to 36 characters long.
- **Copyright:** Enter the name of the copyright holder as described on page 111. Copyright holder names can be up to 54 characters long.

- **Attach copyright information:** Select this option to attach copyright information to all subsequent photographs. **Attach copyright information** can be turned on and off by highlighting it and pressing ►. After choosing the desired setting, press **OK** to exit.



Copyright Information

To prevent unauthorized use of the artist or copyright holder names, make sure that **Attach copyright information** is not selected and that the **Artist** and **Copyright** fields are blank before lending or transferring the camera to another person. Nikon does not accept liability for any damages or disputes arising from the use of the **Copyright information** option.

Save/Load Settings

MENU button → Y setup menu

Select **Save settings** to save the following settings to the memory card in Slot 1 (□ 69; if the card is full, an error will be displayed). Use this option to share settings among D7100 cameras.

Menu	Option	Menu	Option
Playback	Playback display options	Custom settings	All Custom Settings except Reset custom settings
	Image review		Clean image sensor
	After delete		Flicker reduction
	Rotate tall		Time zone and date (excepting date and time)
Shooting	File naming	Setup	Language
	Role played by card in Slot 2		Auto image rotation
	Image quality		Image comment
	Image size		Copyright information
	Image area		Non-CPU lens data
	JPEG compression		HDMI
	NEF (RAW) recording		GPS
	White balance (with fine-tuning and presets d-1–d-6)		Wireless mobile adapter
	Set Picture Control		Eye-Fi upload
	Color space		My Menu/ Recent Settings
	Active D-Lighting	All recent settings	
	Auto distortion control	Choose tab	
	Long exposure NR		
	High ISO NR		
	ISO sensitivity settings		
	Movie settings		

Settings saved using this model of camera can be restored by selecting **Load settings**. Note that **Save/load settings** is only available when a memory card is inserted in the camera, and that the **Load settings** option is only available if the card contains saved settings.

Saved Settings

Settings are saved in a file named NCSETUPB. The camera will not be able to load settings if the file name is changed.

Display a virtual horizon based on information from the camera tilt sensor. If the camera is tilted neither left nor right, the roll reference line will turn green. Each division is equivalent to 5°.

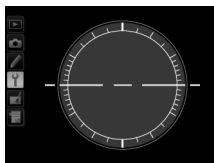

Camera level

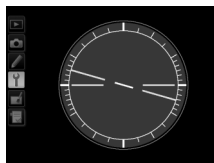

Camera tilted left or right



Tilting the Camera

The virtual horizon display is not accurate when the camera is tilted at a sharp angle forward or back. If the camera is unable to measure tilt, the amount of tilt will not be displayed.

See Also

For information on viewing a virtual horizon in the viewfinder, see Custom Setting f2 (**Assign Fn button**;  253, 254). For information on displaying a virtual horizon in live view, see pages 159 and 166.

Fine-tune focus for up to 12 lens types. AF tuning is not recommended in most situations and may interfere with normal focus; use only when required.

Option	Description
AF fine-tune (On/Off)	<ul style="list-style-type: none"> • On: Turn AF tuning on. • Off: Turn AF tuning off.
Saved value	<p>Tune AF for the current lens (CPU lenses only). Press ▲ or ▼ to choose a value between +20 and -20. Values for up to 12 lens types can be stored. Only one value can be stored for each type of lens.</p>
Default	<p>Choose the AF tuning value used when no previously saved value exists for the current lens (CPU lenses only).</p>
List saved values	<p>List previously saved AF tuning values. To delete a lens from the list, highlight the desired lens and press . To change a lens identifier (for example, to choose an identifier that is the same as the last two digits of the lens serial number to distinguish it from other lenses of the same type in light of the fact that Saved value can be used with only one lens of each type), highlight the desired lens and press ►.</p> <p>The menu shown at right will be displayed; press ▲ or ▼ to choose an identifier and press  to save changes and exit.</p>

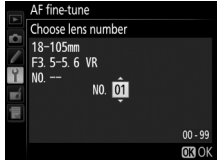
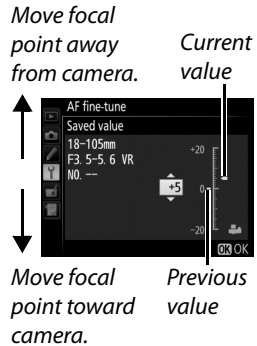

AF Tuning

The camera may be unable to focus at minimum range or at infinity when AF tuning is applied.

Live View

Tuning is not applied to autofocus during in live view ( 153).

Saved Value

Only one value can be stored for each type of lens. If a teleconverter is used, separate values can be stored for each combination of lens and teleconverter.

Wireless Mobile Adapter

MENU button →  setup menu

Choose whether the camera will establish wireless connections with smart devices when an optional WU-1a wireless mobile adapter (📄 310) is attached to the camera USB connector.

Option	Description
Enable	Enable wireless connections to smart devices running the Wireless Mobile Utility.
Disable	Disable wireless connections to smart devices. Choose this option in locations where the use of wireless devices is prohibited. Selecting this option also reduces the drain on the camera battery.



🔧 The Retouch Menu: Creating Retouched Copies

To display the retouch menu, press **MENU** and select the  (retouch menu) tab.

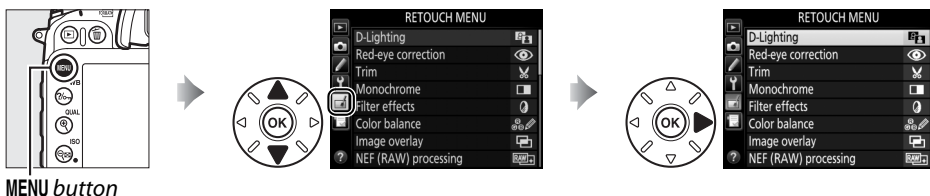

The options in the retouch menu are used to create trimmed or retouched copies of existing pictures. The retouch menu is only displayed when a memory card containing photographs is inserted in the camera (note that if the memory card is being used to store both RAW/NEF and JPEG copies of the same photographs as described on page 66, retouch other than **Image overlay** and **NEF (RAW) processing** apply only to the JPEG copies).

Option	📖	Option	📖
D-Lighting	276	Straighten	285
Red-eye correction	276	Distortion control	285
Trim	277	Fisheye	285
Monochrome	277	Color outline	286
Filter effects	278	Color sketch	286
Color balance	279	Perspective control	286
Image overlay ¹	280	Miniature effect	287
NEF (RAW) processing	282	Selective color	288
Resize	283	Edit movie	173
Quick retouch	284	Side-by-side comparison ²	290

- 1 Can only be selected by pressing **MENU** and selecting .
- 2 Only available if **i** is pressed in full-frame playback when a retouched image or original is displayed.

👍 Retouching Copies

Most options can be applied to copies created using other retouch options, although with the exceptions of **Image overlay** and **Edit movie > Choose start/end point**, each option can be applied only once (note that multiple edits may result in loss of detail). Options that can not be applied to the current image are grayed out and unavailable.

📄 Image Quality

Except in the case of copies created with **Trim**, **Image overlay**, **NEF (RAW) processing**, and **Resize**, copies created from JPEG images are the same size and quality as the original, while copies created from NEF (RAW) photos are saved as large fine-quality JPEG images. Size-priority compression is used when copies are saved in JPEG format.



Creating Retouched Copies

To create a retouched copy:

1 Select an item in the retouch menu.

Press ▲ or ▼ to highlight an item, ► to select.

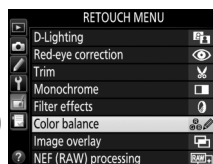

2 Select a picture.

Highlight a picture and press OK (to view the highlighted picture full screen, press and hold the Q (QUAL) button; to view images in other locations as described on page 186, hold BKT and press ▲).

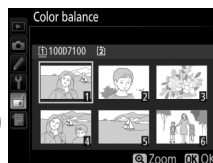

Retouch

The camera may not be able to display or retouch images created with other devices.

3 Select retouch options.

For more information, see the section for the selected item. To exit without creating a retouched copy, press MENU.

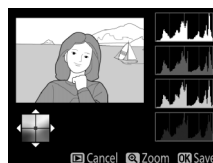

Monitor off Delay

The monitor will turn off and the operation will be cancelled if no actions are performed for a brief period. Any unsaved changes will be lost. To increase the time the monitor remains on, choose a longer menu display time for Custom Setting c4 (Monitor off delay; 238).

4 Create a retouched copy.

Press OK to create a retouched copy. Retouched copies are indicated by a  icon.



Creating Retouched Copies During Playback

Retouched copies can also be created during playback.



*Display picture full frame and press **i**.*

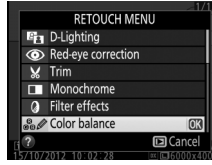

*Highlight an option and press **OK**.*

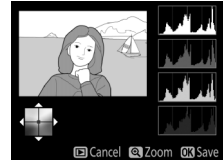

Create retouched copy.

D-Lighting

MENU button →  retouch menu

D-lighting brightens shadows, making it ideal for dark or backlit photographs.



Before



After



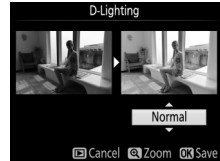





Press ▲ or ▼ to choose the amount of correction performed. The effect can be previewed in the edit display. Press  to copy the photograph.



Red-Eye Correction

MENU button →  retouch menu

This option is used to correct “red-eye” caused by the flash, and is available only with photographs taken using the flash. The photograph selected for red-eye correction can be previewed in the edit display. Confirm the effects of red-eye correction and create a copy as described in the following table. Note that red-eye correction may not always produce the expected results and may in very rare circumstances be applied to portions of the image that are not affected by red-eye; check the preview thoroughly before proceeding.

To	Use	Description
Zoom in	 (QUAL)	Press  (QUAL) to zoom in,  (ISO) to zoom out. While photo is zoomed in, use multi selector to view areas of image not visible in monitor. Keep multi selector pressed to scroll rapidly to other areas of frame. Navigation window is displayed when zoom buttons or multi selector is pressed; area currently visible in monitor is indicated by yellow border. Press  to cancel zoom.
Zoom out	 (ISO)	
View other areas of image		
Cancel zoom		
Create copy		If the camera detects red-eye in the selected photograph, a copy will be created that has been processed to reduce its effects. No copy will be created if the camera is unable to detect red-eye.

Trim

MENU button → retouch menu

Create a cropped copy of the selected photograph. The selected photograph is displayed with the selected crop shown in yellow; create a cropped copy as described in the following table.



To	Use	Description
Reduce size of crop	(ISO)	Press (ISO) to reduce the size of the crop.
Increase size of crop	(QUAL)	Press (QUAL) to increase the size of the crop.
Change crop aspect ratio		Rotate the main command dial to switch between aspect ratios of 3 : 2, 4 : 3, 5 : 4, 1 : 1, and 16 : 9.
Position crop		Use multi selector to position the crop. Press and hold to move the crop rapidly to the desired position.
Create copy		Save the current crop as a separate file.

Trim: Image Quality and Size

Copies created from NEF (RAW) or NEF (RAW) + JPEG photos have an image quality (66) of JPEG fine; cropped copies created from JPEG photos have the same image quality as the original. The size of the copy varies with crop size and aspect ratio and appears at upper left in the crop display.



Viewing Cropped Copies

Playback zoom may not be available when cropped copies are displayed.

Monochrome

MENU button → retouch menu

Copy photographs in **Black-and-white**, **Sepia**, or **Cyanotype** (blue and white monochrome).

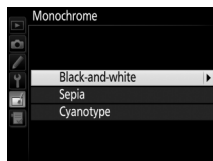

Selecting **Sepia** or **Cyanotype** displays a preview of the selected image; press to increase color saturation, to decrease. Press to create a monochrome copy.

Increase saturation



Decrease saturation

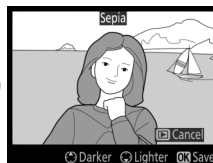

Filter Effects

MENU button →  retouch menu

Choose from the following filter effects. After adjusting filter effects as described below, press **OK** to copy the photograph.

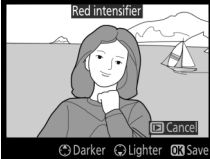
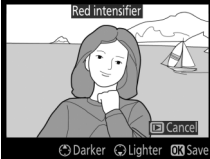
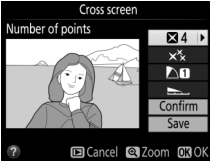
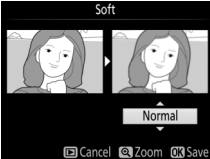
Option	Description	
Skylight	Creates the effect of a skylight filter, making the picture less blue. The effect can be previewed in the monitor as shown at right.	
Warm filter	Creates a copy with warm tone filter effects, giving the copy a “warm” red cast. The effect can be previewed in the monitor.	
Red intensifier Green intensifier Blue intensifier	Intensify reds (Red intensifier), greens (Green intensifier), or blues (Blue intensifier). Press ▲ to increase the effect, ▼ to decrease.	
Cross screen	<p>Add starburst effects to light sources.</p> <ul style="list-style-type: none"> • Number of points: Choose from four, six, or eight. • Filter amount: Choose the brightness of the light sources affected. • Filter angle: Choose the angle of the points. • Length of points: Choose the length of points. • Confirm: Preview the effects of the filter as shown at right. Press QUAL to preview the copy full frame. • Save: Create a retouched copy. 	
Soft	Add a soft filter effect. Press ▲ or ▼ to choose the filter strength.	



Color Balance

MENU button →  retouch menu

Use the multi selector to create a copy with modified color balance as shown below. The effect is displayed in the monitor together with red, green, and blue histograms (📖 189) giving the distribution of tones in the copy.

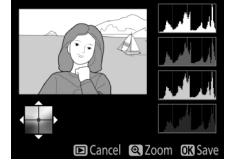

Zoom

To zoom in on the image displayed in the monitor, press **QUAL**. The histogram will be updated to show data only for the portion of the image displayed in the monitor. While the image is zoomed in, press **WB** to toggle back and forth between color balance and zoom. When zoom is selected, you can zoom in and out with the **QUAL** and **ISO** and scroll the image with the multi selector.

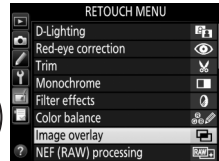

Image overlay combines two existing NEF (RAW) photographs to create a single picture that is saved separately from the originals; the results, which make use of RAW data from the camera image sensor, are noticeably better than overlays created in an imaging application. The new picture is saved at current image quality and size settings; before creating an overlay, set image quality and size (☐ 66, 68; all options are available). To create a NEF (RAW) copy, choose an image quality of **NEF (RAW)**.



1 Select Image overlay.

Highlight **Image overlay** in the retouch menu and press ►.



The dialog shown at right will be displayed, with **Image 1** highlighted; press **OK** to display a list of the NEF pictures created with this camera.

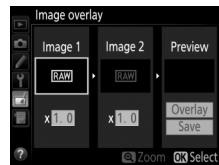

2 Select the first image.

Use the multi selector to highlight the first photograph in the overlay. To view the highlighted photograph full frame, press and hold the **Q** (QUAL) button (to view images in other locations as described on page 186, hold **BKT** and press ▲). Press **OK** to select the highlighted photograph and return to the preview display.

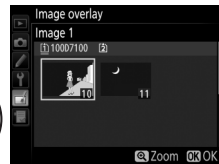

3 Select the second image.

The selected image will appear as **Image 1**. Highlight **Image 2** and press **OK**, then select the second photo as described in Step 2.



4 Adjust gain.

Highlight **Image 1** or **Image 2** and optimize exposure for the overlay by pressing ▲ or ▼ to select gain from values between 0.1 and 2.0. Repeat for the second image. The default value is 1.0; select 0.5 to halve gain or 2.0 to double it. The effects are visible in the **Preview** column.

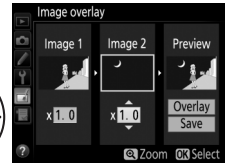

5 Preview the overlay.

Press ◀ or ▶ to place the cursor in the **Preview** column and press ▲ or ▼ to highlight **Overlay**. Press OK to preview the overlay as shown at right (to save the overlay without displaying a preview, select **Save**). To return to Step 4 and select new photos or adjust gain, press **ISO**.



6 Save the overlay.

Press OK while the preview is displayed to save the overlay. After an overlay is created, the resulting image will be displayed full-frame in the monitor.



Image Overlay

Only NEF (RAW) photographs with the same image area and bit depth can be combined.

The overlay has the same photo info (including date of recording, metering, shutter speed, aperture, shooting mode, exposure compensation, focal length, and image orientation), and values for white balance and Picture Control as the photograph selected for **Image 1**. The current image comment is appended to the overlay when it is saved; copyright information, however, is not copied. Overlays saved in NEF (RAW) format use the compression selected for **Type** in the **NEF (RAW) recording** menu and have the same bit depth as the original images; JPEG overlays are saved using size-priority compression.

Create JPEG copies of NEF (RAW) photographs.

1 Select NEF (RAW) processing.

Highlight **NEF (RAW) processing** in the retouch menu and press **▶** to display a picture selection dialog listing only NEF (RAW) images created with this camera.

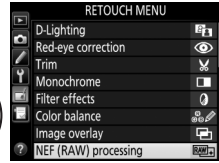

2 Select a photograph.

Highlight a photograph (to view the highlighted photograph full frame, press and hold the **QUAL** button; to view images in other locations as described on page 186, hold **BKT** and press **▲**). Press **OK** to select the highlighted photograph and proceed to the next step.

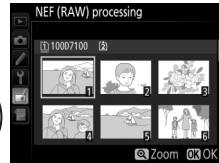

3 Choose settings for the JPEG copy.

Adjust the settings listed below. Note that white balance is not available with multiple exposures or pictures created with image overlay and that exposure compensation can only be set to values between -2 and $+2$ EV. The Picture Control grid is not displayed when Picture Controls are adjusted.



NEF (RAW) processing

Image quality

EXE

NORM ▶

Image size (□ 68)

WB A₁

0.0

SD

ISO NR N

? Cancel Zoom OK OK

NEF (RAW) processing

Color space

sRGB ▶

D-Lighting N

? Cancel Zoom OK OK

4 Copy the photograph.

Highlight **EXE** and press **OK** to create a JPEG copy of the selected photograph (to exit without copying the photograph, press the **MENU** button).



Resize

MENU button → *retouch menu*

Create small copies of selected photographs. Photographs with an aspect ratio of 16 : 9 (📖 163) can not be resized.

1 Select Resize.

To resize selected images, press **MENU** to display the menus and select **Resize** in the retouch menu.



2 Choose a destination.

If two memory cards are inserted, you can choose a destination for the resized copies by highlighting **Choose destination** and pressing **▶** (if only one card is inserted, proceed to Step 3).

The menu shown at right will be displayed; highlight a card slot and press **OK**.

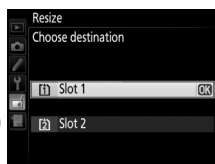
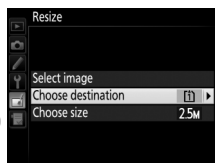

3 Choose a size.

Highlight **Choose size** and press **▶**.

The options shown at right will be displayed; highlight an option and press **OK**.

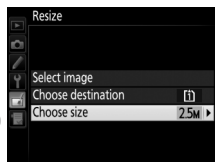

4 Choose pictures.

Highlight **Select image** and press **▶**.

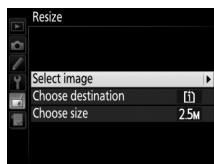

The dialog shown at right will be displayed; highlight pictures using the multi selector and press the **ISO** button to select or deselect (to view the highlighted picture full screen, press and hold the **QUAL** button; to view images in other locations as described on page 186, hold **BKT** and press **▲**). Selected pictures are marked by a  icon. Press **OK** when the selection is complete.



5 Save the resized copies.

A confirmation dialog will be displayed. Highlight **Yes** and press **OK** to save the resized copies.



Viewing Resized Copies

Playback zoom may not be available when resized copies are displayed.

Image Quality

Copies created from NEF (RAW) or NEF (RAW) + JPEG photos have an image quality (📄 66) of JPEG fine; copies created from JPEG photos have the same image quality as the original.

Quick Retouch

MENU button →  retouch menu

Create copies with enhanced saturation and contrast. D-Lighting is applied as required to brighten dark or backlit subjects.

Press **▲** or **▼** to choose the amount of enhancement. The effect can be previewed in the edit display. Press **OK** to copy the photograph.

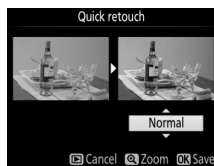

Straighten

MENU button →  retouch menu

Create a straightened copy of the selected image. Press **▶** to rotate the image clockwise by up to five degrees in increments of approximately 0.25 degrees, **◀** to rotate it counterclockwise (the effect can be previewed in the edit display; note that edges of the image will be trimmed to create a square copy). Press **OK** to copy the photograph, or press **▶** to exit to playback without creating a copy.

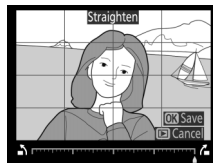

Distortion Control

MENU button →  retouch menu

Create copies with reduced peripheral distortion. Select **Auto** to let the camera correct distortion automatically and then make fine adjustments using the multi selector, or select **Manual** to reduce distortion manually (note that **Auto** is not available with photos taken using auto distortion control; see page 227). Press **▶** to reduce barrel distortion, **◀** to reduce pin-cushion distortion (the effect can be previewed in the edit display; note that greater amounts of distortion control result in more of the edges being cropped out). Press **OK** to copy the photograph, or press **▶** to exit to playback without creating a copy.

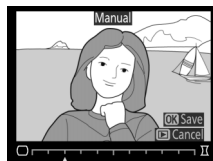

Auto

Auto is for use only with pictures taken with type G and D lenses (PC, fisheye, and certain other lenses excluded). Results are not guaranteed with other lenses.

Fisheye

MENU button →  retouch menu

Create copies that appear to have been taken with a fisheye lens. Press **▶** to increase the effect (this also increases the amount of that will be cropped out at the edges of the image), **◀** to reduce it. The effect can be previewed in the edit display. Press **OK** to copy the photograph, or press **▶** to exit to playback without creating a copy.

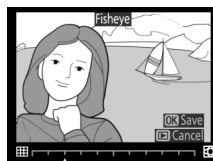

Color Outline

MENU button →  retouch menu

Create an outline copy of a photograph to use as a base for painting. The effect can be previewed in the edit display. Press **OK** to copy the photograph.

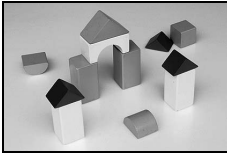

Before

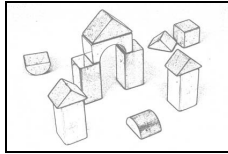

After

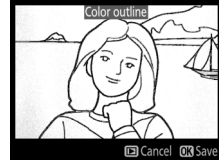

Color Sketch

MENU button →  retouch menu

Create a copy of a photograph that resembles a sketch made with colored pencils. Press **▲** or **▼** to highlight **Vividness** or **Outlines** and press **◀** or **▶** to change. Vividness can be increased to make colors more saturated, or decreased for a washed-out, monochromatic effect, while outlines can be made thicker or thinner. Thicker outlines makes colors more saturated. The results can be previewed in the edit display. Press **OK** to copy the photograph, or press **▶** to exit to playback without creating a copy.

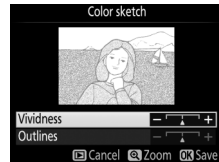

Perspective Control

MENU button →  retouch menu

Create copies that reduce the effects of perspective taken from the base of a tall object. Use the multi selector to adjust perspective (note that greater amounts of perspective control result in more of the edges being cropped out). The results can be previewed in the edit display. Press **OK** to copy the photograph, or press **▶** to exit to playback without creating a copy.



Before











After



Miniature Effect

MENU button →  retouch menu

Create a copy that appears to be a photo of a diorama. Works best with photos taken from a high vantage point. The area that will be in focus in the copy is indicated by a yellow frame.

To	Press	Description
Choose orientation	 (ISO)	Press  (ISO) to choose orientation of area that is in focus.
Choose position		If area of effect is in wide orientation, press ▲ or ▼ to position frame showing area of copy that will be in focus.
		If area of effect is in tall orientation, press ◀ or ▶ to position frame showing area of copy that will be in focus.
Choose size		If area of effect is in wide orientation, press ◀ or ▶ to choose height.
		If area of effect is in tall orientation, press ▲ or ▼ to choose width.
Preview copy	 (QUAL)	Preview copy.
Cancel		Exit to full-frame playback without creating copy.
Create copy		Create copy.



Area in focus

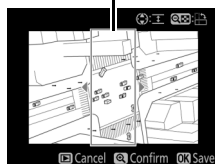

Create a copy in which only selected hues appear in color.

1 Select Selective color.

Highlight **Selective color** in the retouch menu and press **▶** to display a picture selection dialog.

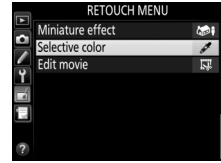

2 Select a photograph.

Highlight a photograph (to view the highlighted photograph full frame, press and hold the **QUAL** button; to view images in other locations as described on page 186, hold **BKT** and press **▲**). Press **OK** to select the highlighted photograph and proceed to the next step.



3 Select a color.

Use the multi selector to position the cursor over an object and press the **AE-L/AF-L** button to select the color of the object as one that will remain in the final copy (the camera may have difficulty detecting unsaturated colors; choose a saturated color). To zoom in on the picture for precise color selection, press **QUAL**. Press **ISO** to zoom out.

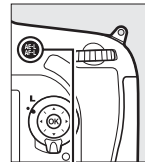

AE-L/AF-L button

Selected color

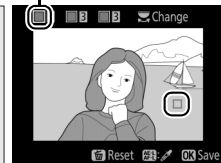

4 Highlight the color range.

Rotate the main command dial to highlight the color range for the selected color.



Color range



5 Choose the color range.

Press ▲ or ▼ to increase or decrease the range of similar hues that will be included in the final photograph. Choose from values between 1 and 7; note that higher values may include hues from other colors. The effect can be previewed in the edit display.



6 Select additional colors.

To select additional colors, rotate the main command dial to highlight another of the three color boxes at the top of the display and repeat Steps 3–5 to select another color.



Repeat for a third color if desired (To deselect the highlighted color, press /FORMAT, or press and hold  to remove all colors. A confirmation dialog will be displayed; select **Yes**).

7 Save the edited copy.

Press  to copy the photograph.



Side-by-side Comparison

Compare retouched copies to the original photographs. This option is only available if **i** button is pressed to display the retouch menu when a copy or original is played back full frame.

1 Select a picture.

In full-frame playback, select a retouched copy (shown by a  icon) or a photograph that has been retouched and press **i**.

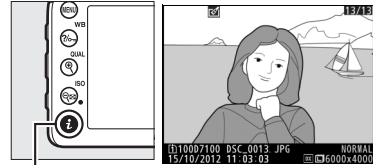

i button

2 Select Side-by-side comparison.

Highlight **Side-by-side comparison** and press **OK**.

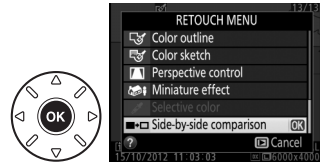



3 Compare the copy with the original.

The source image is displayed on the left, the retouched copy on the right, with the options used to create the copy listed at the top of the display. Press **◀** or **▶** to switch between the source image and the retouched copy. To view the highlighted picture full frame, press and hold the **QUAL** button. If the copy was created from two source images using **Image overlay**, or if the source has been copied multiple times, press **▲** or **▼** to view the other source images or copies. To exit to playback mode, press the **▶** button, or press **OK** to exit to playback with the highlighted image selected.

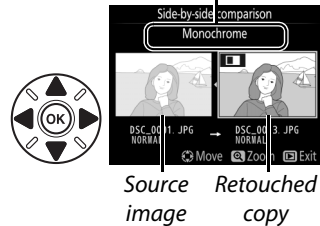
Options used to create copy



Side-by-side Comparisons

The source image will not be displayed if the copy was created from a photograph that was protected (, 196), is on a locked memory card, has since been deleted or hidden (, 218), or is on a card in a different slot from that used when the image was created.

My Menu / Recent Settings

To display My Menu, press **MENU** and select the  (My Menu) tab.

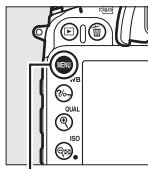

MENU button

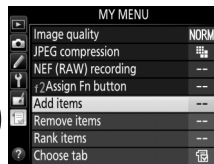
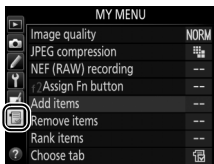

The **My Menu** option can be used to create and edit a customized list of options from the playback, shooting, Custom Settings, setup, and retouch menus for quick access (up to 20 items). If desired, recent settings can be displayed in place of My Menu ( 294).

Options can be added, deleted, and reordered as described below.

■ Adding Options to My Menu

1 Select Add items.

In My Menu () , highlight **Add items** and press **▶**.

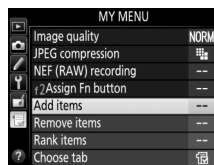

2 Select a menu.

Highlight the name of the menu containing the option you wish to add and press **▶**.

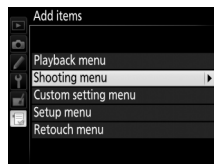

3 Select an item.

Highlight the desired menu item and press **OK**.

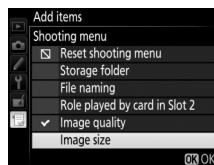

4 Position the new item.

Press **▲** or **▼** to move the new item up or down in My Menu. Press **OK** to add the new item.



5 Add more items.

The items currently displayed in My Menu are indicated by a check mark. Items indicated by a  icon can not be selected. Repeat Steps 1–4 to select additional items.

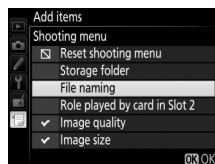

Deleting Options from My Menu

1 Select Remove items.

In My Menu () , highlight **Remove items** and press **▶**.

2 Select items.

Highlight items and press **▶** to select or deselect. Selected items are indicated by a check mark.

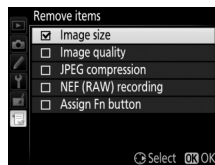

3 Delete the selected items.

Press **OK**. A confirmation dialog will be displayed; press **OK** again to delete the selected items.

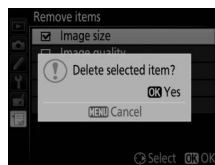

Deleting Items in My Menu

To delete the item currently highlighted in My Menu, press the  (**FORMAT**) button. A confirmation dialog will be displayed; press  (**FORMAT**) again to remove the selected item from My Menu.

■ Reordering Options in My Menu

1 Select Rank items.

In My Menu (☰), highlight **Rank items** and press ►.

2 Select an item.

Highlight the item you wish to move and press **OK**.



3 Position the item.

Press ▲ or ▼ to move the item up or down in My Menu and press **OK**. Repeat Steps 2–3 to reposition additional items.



4 Exit to My Menu.

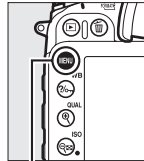

Press the **MENU** button to return to My Menu.



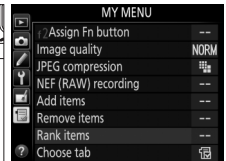

MENU button



Recent Settings



To display the twenty most recently used settings, select  **Recent settings** for  **My Menu > Choose tab.**

1 Select Choose tab.



In My Menu () , highlight **Choose tab** and press .



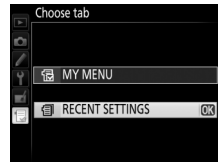

2 Select **Recent settings.**

Highlight  **Recent settings** and press .
The name of the menu will change from “MY MENU” to “RECENT SETTINGS.”



Menu items will be added to the top of the recent settings menu as they are used. To view My Menu again, select  **My Menu** for  **Recent settings > Choose tab.**

Removing Items from the Recent Settings Menu

To remove an item from the recent settings menu, highlight it and press the  (**FORMAT**) button. A confirmation dialog will be displayed; press  (**FORMAT**) again to delete the selected item.



Technical Notes

Read this chapter for information on compatible accessories, cleaning and storing the camera, and what to do if an error message is displayed or you encounter problems using the camera.

Compatible Lenses

Lens/accessory		Camera setting		Focus mode			Shooting mode		Metering system		
		AF	M (with electronic rangefinder)	M	P S	A M	☑		☑		
							3D	Color			
CPU lenses ¹	Type G or D AF NIKKOR ² AF-S, AF-I NIKKOR	✓	✓	✓	✓	✓	✓	—	✓ ³		
	PC-E NIKKOR series	—	✓ ⁵	✓	✓ ⁵	✓ ⁵	✓ ⁵	—	✓ ^{3,5}		
	PC Micro 85mm f/2.8D ⁴	—	✓ ⁵	✓	—	✓ ⁶	✓	—	✓ ^{3,5}		
	AF-S / AF-I Teleconverter ⁷	✓	✓	✓	✓	✓	✓	—	✓ ³		
	Other AF NIKKOR (except lenses for F3AF)	✓ ⁸	✓ ⁸	✓	✓	✓	—	✓	✓ ³		
	AI-P NIKKOR	—	✓ ⁹	✓	✓	✓	—	✓	✓ ³		
Non-CPU lenses ¹⁰	AI-, AI-modified, NIKKOR or Nikon Series E lenses ¹¹	—	✓ ⁹	✓	—	✓ ¹²	—	✓ ¹³	✓ ¹⁴		
	Medical-NIKKOR 120mm f/4	—	✓	✓	—	✓ ¹⁵	—	—	—		
	Reflex-NIKKOR	—	—	✓	—	✓ ¹²	—	—	✓ ¹⁴		
	PC-NIKKOR	—	✓ ⁵	✓	—	✓ ¹⁶	—	—	✓		
	AI-type Teleconverter ¹⁷	—	✓ ¹⁸	✓	—	✓ ¹²	—	✓ ¹³	✓ ¹⁴		
	PB-6 Bellows Focusing Attachment ¹⁹	—	✓ ¹⁸	✓	—	✓ ²⁰	—	—	✓		
Auto extension rings (PK-series 11A, 12, or 13; PN-11)	—	✓ ¹⁸	✓	—	✓ ¹²	—	—	✓			

1 IX-NIKKOR lenses can not be used.

2 Vibration Reduction (VR) supported with VR lenses.

3 Spot metering meters selected focus point (☑ 83).

4 The camera's exposure metering and flash control systems do not work properly when shifting and/or tilting the lens, or when an aperture other than the maximum aperture is used.

5 Can not be used with shifting or tilting.

6 Manual shooting mode only.

7 Can be used with AF-S and AF-I lenses only (☑ 297). For information on the focus points available for autofocus and electronic rangefinding, see page 297.

8 When focusing at minimum focus distance with AF 80–200mm f/2.8, AF 35–70mm f/2.8, AF 28–85mm f/3.5–4.5 <New>, or AF 28–85mm f/3.5–4.5 lens at maximum zoom, in-focus indicator (●) may be displayed when image on matte screen in viewfinder is not in focus. Adjust focus manually until image in viewfinder is in focus.

9 With maximum aperture of f/5.6 or faster.

10 Some lenses can not be used (see page 298).



- 11 Range of rotation for AI 80–200mm f/2.8 ED tripod mount is limited by camera body. Filters can not be exchanged while AI 200–400mm f/4 ED is mounted on camera.
- 12 If maximum aperture is specified using **Non-CPU lens data** (□ 149), aperture value will be displayed in viewfinder and control panel.
- 13 Can be used only if lens focal length and maximum aperture are specified using **Non-CPU lens data** (□ 149). Use spot or center-weighted metering if desired results are not achieved.
- 14 For improved precision, specify lens focal length and maximum aperture using **Non-CPU lens data** (□ 149).
- 15 Can be used in manual mode **M** at shutter speeds slower than flash sync speed by one step or more.
- 16 Exposure determined by presetting lens aperture. In mode **A**, preset aperture using lens aperture ring before performing AE lock and shifting lens. In mode **M**, preset aperture using lens aperture ring and determine exposure before shifting lens.
- 17 Exposure compensation required when used with AI 28–85mm f/3.5–4.5, AI 35–105mm f/3.5–4.5, AI 35–135mm f/3.5–4.5, or AF-S 80–200mm f/2.8D. See teleconverter manual for details.
- 18 With maximum effective aperture of f/5.6 or faster.
- 19 Requires PK-12 or PK-13 auto extension ring. PB-6D may be required depending on camera orientation.
- 20 Use preset aperture. In mode **A**, set aperture using focusing attachment before determining exposure and taking photograph.
 - PF-4 Reprocopy Outfit requires PA-4 Camera Holder.
 - Noise in the form of horizontal lines may appear in movies taken with the following lenses at ISO sensitivities of 6400 or higher; use manual focus or focus lock.
 - AF-S Zoom Nikkor 24–85mm f/3.5–4.5G (IF)
 - AF-S DX Zoom-Nikkor 18–70mm f/3.5–4.5G IF-ED

Recognizing CPU and Type G and D Lenses

CPU lenses (particularly types G and D) are recommended, but note that IX-NIKKOR lenses can not be used. CPU lenses can be identified by the presence of CPU contacts, type G and D lenses by a letter on the lens barrel. Type G lenses are not equipped with a lens aperture ring.

CPU contacts

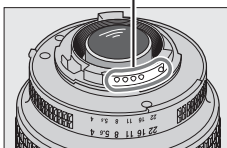

CPU lens

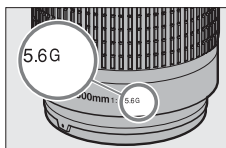

Type G lens

Aperture ring

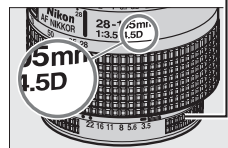

Type D lens

The AF-S/AF-I Teleconverter

The AF-S/AF-I teleconverter can be used with the following AF-S and AF-I lenses:

- AF-S NIKKOR 70–200mm f/2.8G ED VR II
- AF-S VR 70–200mm f/2.8G ED
- AF-S 80–200mm f/2.8D ED
- AF-S VR Micro-Nikkor 105mm f/2.8G IF-ED *
- AF-S NIKKOR 200mm f/2G ED VR II
- AF-S VR 200mm f/2G ED
- AF-S NIKKOR 200–400mm f/4G ED VR II
- AF-S VR 200–400mm f/4G ED
- AF-S NIKKOR 300mm f/2.8G ED VR II
- AF-S VR 300mm f/2.8G ED
- AF-S 300mm f/2.8D ED II
- AF-S 300mm f/2.8D ED
- AF-I 300mm f/2.8D ED
- AF-S 300mm f/4D ED
- AF-S NIKKOR 400mm f/2.8G ED VR
- AF-S 400mm f/2.8D ED II
- AF-S 400mm f/2.8D ED
- AF-I 400mm f/2.8D ED
- AF-S NIKKOR 500mm f/4G ED VR
- AF-S 500mm f/4D ED II
- AF-S 500mm f/4D ED
- AF-I 500mm f/4D ED
- AF-S NIKKOR 600mm f/4G ED VR
- AF-S 600mm f/4D ED II
- AF-S 600mm f/4D ED
- AF-I 600mm f/4D ED

* Autofocus not supported.

Autofocus Support

If the combined aperture when the camera is used with an AF-S teleconverter is slower than f/5.6 but is equal to or faster than f/8, autofocus and electronic rangefinding will be available only with the focus point shown at right and the camera may be unable to focus on dark or low-contrast subjects. Single point AF is used when 3D-tracking or auto-area AF is selected for AF-area mode (□ 73).

TC-17E II/TC-20E/
TC-20E II/TC-20E III

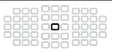

Lens f-number

The f-number given in lens names is the maximum aperture of the lens.

Compatible Non-CPU Lenses

When using non-CPU lenses and accessories, rotate the camera mode dial to **A** or **M** and set aperture using the lens aperture ring. In other modes, the shutter-release is disabled. **Non-CPU lens data** (☐ 149) can be used to enable many of the features available with CPU lenses, including color matrix metering; if no data are provided, center-weighted metering will be used in place of color matrix metering, while if the maximum aperture is not provided, the camera aperture display will show the number of stops from maximum aperture and the actual aperture value must be read off the lens aperture ring.

Incompatible Accessories and Non-CPU Lenses

The following can NOT be used with the D7100:

- TC-16AS AF teleconverter
- Non-AI lenses
- Lenses that require the AU-1 focusing unit (400mm f/4.5, 600mm f/5.6, 800mm f/8, 1200mm f/11)
- Fisheye (6mm f/5.6, 7.5mm f/5.6, 8mm f/8, OP 10mm f/5.6)
- 2.1cm f/4
- Extension Ring K2
- 180–600mm f/8 ED (serial numbers 174041–174180)
- 360–1200mm f/11 ED (serial numbers 174031–174127)
- 200–600mm f/9.5 (serial numbers 280001–300490)
- AF lenses for the F3AF (AF 80mm f/2.8, AF 200mm f/3.5 ED, AF Teleconverter TC-16)
- PC 28mm f/4 (serial number 180900 or earlier)
- PC 35mm f/2.8 (serial numbers 851001–906200)
- PC 35mm f/3.5 (old type)
- Reflex 1000mm f/6.3 (old type)
- Reflex 1000mm f/11 (serial numbers 142361–143000)
- Reflex 2000mm f/11 (serial numbers 200111–200310)



The Built-in Flash

The built-in flash can be used with CPU lenses with focal lengths of 16–300 mm, although in some cases the flash may be unable to entirely light the subject at some ranges or focal lengths due to shadows cast by the lens, while lenses that block the subject's view of the red-eye reduction lamp may interfere with red-eye reduction. Remove lens hoods to prevent shadows. The flash has a minimum range of 0.6 m (2 ft) and can not be used in the macro range of macro zoom lenses. When **DX (24×16)** is selected for **Image area**, the flash may be unable to light the entire subject with the following lenses at ranges less than those given below:

Lens	Zoom position	Minimum distance without vignetting
AF-S DX NIKKOR 10–24mm f/3.5–4.5G ED	18 mm	1.0 m/3 ft 3 in.
	20 mm	1.0 m/3 ft 3 in.
	24 mm	No vignetting
AF-S DX Zoom-Nikkor 12–24mm f/4G IF-ED	18 mm	1.5 m/4 ft 11 in.
	20 mm	1.0 m/3 ft 3 in.
	24 mm	No vignetting
AF-S DX Zoom-Nikkor 17–55mm f/2.8G IF-ED	24 mm	1.0 m/3 ft 3 in.
	28–55 mm	No vignetting
AF-S DX VR Zoom-Nikkor 18–200mm f/3.5–5.6G IF-ED	18 mm	1.0 m/3 ft 3 in.
AF-S DX NIKKOR 18–200mm f/3.5–5.6G ED VR II	24–200 mm	No vignetting
AF-S DX NIKKOR 18–300mm f/3.5–5.6G ED VR	28 mm	1.5 m/4 ft 11 in.
	50–300 mm	No vignetting
AF-S NIKKOR 16–35mm f/4G ED VR	24 mm	1.5 m/4 ft 11 in.
	28 mm	1.0 m/3 ft 3 in.
	35 mm	No vignetting
AF-S Zoom-Nikkor 17–35mm f/2.8D IF-ED	20 mm	3.0 m/9 ft 10 in.
	24 mm	1.0 m/3 ft 3 in.
	28–35 mm	No vignetting
AF Zoom-Nikkor 18–35mm f/3.5– 4.5D IF-ED	18 mm	1.5 m/4 ft 11 in.
	24–35 mm	No vignetting
AF-S NIKKOR 24–70mm f/2.8G ED	28 mm	1.5 m/4 ft 11 in.
	35 mm	1.0 m/3 ft 3 in.
	50–70 mm	No vignetting
AF-S Zoom-Nikkor 28–70mm f/2.8D IF-ED	28 mm	1.5 m/4 ft 11 in.
	35–70 mm	No vignetting
AF-S NIKKOR 14–24mm f/2.8G ED	When DX (24×16) is selected for Image area , the flash will be unable to light the entire subject at all ranges.	

When **1.3x (18x12)** is selected for **Image area**, the flash may be unable to light the entire subject with the following lenses at ranges less than those given below.

Lens	Zoom position	Minimum distance without vignetting
AF-S DX NIKKOR 10–24mm f/3.5–4.5G ED	15–24 mm	No vignetting
AF-S DX Zoom-Nikkor 12–24mm f/4G IF-ED	15 mm	1.0 m/3 ft 3 in.
	18–24 mm	No vignetting
AF-S DX Zoom-Nikkor 17–55mm f/2.8G IF-ED	20 mm	1.0 m/3 ft 3 in.
	24–55 mm	No vignetting
AF-S DX NIKKOR 18–300mm f/3.5–5.6G ED VR	28 mm	1.0 m/3 ft 3 in.
	50–300 mm	No vignetting
AF-S NIKKOR 14–24mm f/2.8G ED	24 mm	3.0 m/9 ft 10 in.
AF-S NIKKOR 16–35mm f/4G ED VR	20 mm	1.5 m/4 ft 11 in.
	24 mm	1.0 m/3 ft 3 in.
	28–35 mm	No vignetting
AF-S Zoom-Nikkor 17–35mm f/2.8D IF-ED	17 mm	1.5 m/4 ft 11 in.
	20 mm	1.0 m/3 ft 3 in.
	24–35 mm	No vignetting
AF-S NIKKOR 24–70mm f/2.8G ED	24 mm	1.5 m/4 ft 11 in.
	28 mm	1.0 m/3 ft 3 in.
	35–70 mm	No vignetting

The built-in flash can also be used with AI-S, AI-, AI-modified NIKKOR, Nikon Series E and non-CPU lenses with a focal length of 16–300 mm. AI 50–300mm f/4.5, modified AI 50–300mm f/4.5, AI 50–300mm f/4.5 ED, and AI-S 50–300mm f/4.5 ED lenses must be used at a zoom position of 70 mm or above.



AF-Assist Illumination

AF-assist illumination is not available with the following lenses:

- AF-S NIKKOR 14–24mm f/2.8G ED
- AF-S NIKKOR 200mm f/2G ED VR II
- AF-S VR Nikkor 200mm f/2G IF-ED
- AF-S VR Zoom-Nikkor 200–400mm f/4G IF-ED
- AF-S NIKKOR 200–400mm f/4G ED VR II
- AF-S NIKKOR 300mm f/2.8G ED VR II

At ranges under 0.7 m (2 ft 4 in.), the following lenses may block the AF-assist illuminator and interfere with autofocus when lighting is poor:

- AF-S Zoom-Nikkor 17–35mm f/2.8D IF-ED
- AF-S DX Zoom-Nikkor 17–55mm f/2.8G IF-ED
- AF Zoom-Nikkor 20–35mm f/2.8D IF
- AF Zoom-Nikkor 24–85mm f/2.8–4D IF
- AF-S NIKKOR 24–85mm f/3.5–4.5G ED VR
- AF-S VR Zoom-Nikkor 24–120mm f/3.5–5.6G IF-ED
- AF-S NIKKOR 35mm f/1.4G
- AF Micro-Nikkor 200mm f/4D IF-ED

At ranges under 1.0 m (3 ft 3 in.), the following lenses may block the AF-assist illuminator and interfere with autofocus when lighting is poor:

- AF-S DX VR Zoom-Nikkor 18–200mm f/3.5–5.6G IF-ED
- AF-S NIKKOR 24–70mm f/2.8G ED
- AF Zoom-Nikkor 24–120mm f/3.5–5.6D IF
- AF-S Zoom-Nikkor 28–70mm f/2.8D IF-ED
- AF Zoom Micro Nikkor ED 70–180mm f/4.5–5.6D
- AF-S VR Micro-Nikkor 105mm f/2.8G IF-ED

At ranges under 1.5 m (4 ft 11 in.), the following lenses may block the AF-assist illuminator and interfere with autofocus when lighting is poor:

- AF-S DX NIKKOR 18–300mm f/3.5–5.6G ED VR
- AF-S NIKKOR 24–120mm f/4G ED VR
- AF-S NIKKOR 28–300mm f/3.5–5.6G ED VR
- AF-S DX NIKKOR 55–300mm f/4.5–5.6G ED VR
- AF-S NIKKOR 70–200mm f/2.8G ED VR II
- AF Zoom-Nikkor 80–200mm f/2.8D ED

At ranges under 2.0 m (6 ft 7 in.), the following lenses may block the AF-assist illuminator and interfere with autofocus when lighting is poor:

- AF-S VR Zoom-Nikkor ED 70–200mm f/2.8G (IF)
- AF-S NIKKOR 70–200mm f/4G ED VR
- AF-S Zoom Nikkor ED 80–200mm f/2.8D (IF)



Calculating Angle of View

The size of the area exposed by a 35mm camera is 36×24 mm. The size of the area exposed by the D7100 when **DX (24×16)** is selected for **Image area** in the shooting menu, in contrast, is 23.5×15.6 mm, meaning that the angle of view of a 35mm camera is approximately 1.5 times that of the D7100 (when **1.3× (18×12)** is selected, the size of the area exposed is reduced and the angle of view is reduced by a further 1.3×).

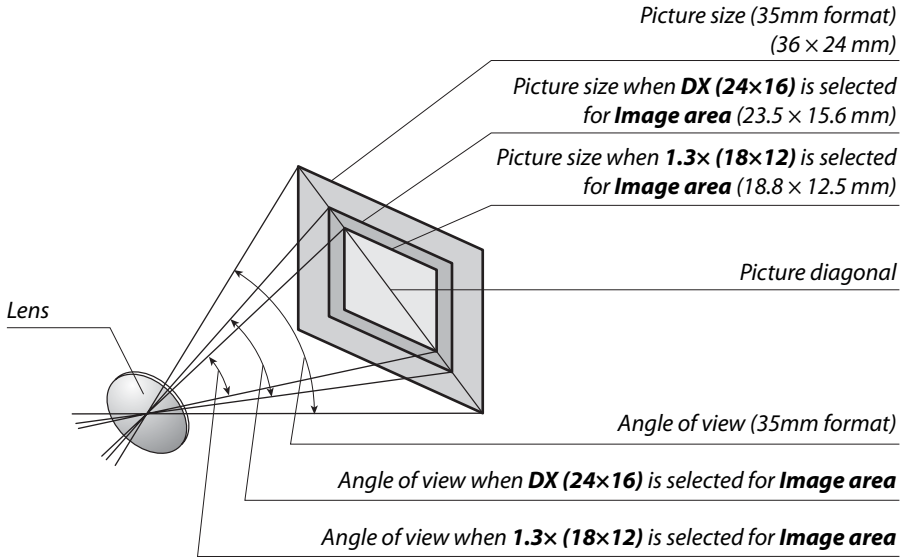

Optional Flash Units (Speedlights)

The camera supports the Nikon Creative Lighting System (CLS) and can be used with CLS-compatible flash units. Optional flash units can be attached directly to the camera accessory shoe as described below. The accessory shoe is equipped with a safety lock for flash units with a locking pin.

1 Remove the accessory shoe cover.

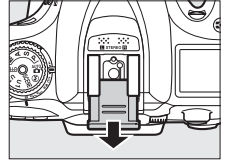

2 Mount the flash unit on the accessory shoe.

See the manual provided with the flash unit for details. The built-in flash will not fire when an optional flash unit is attached.

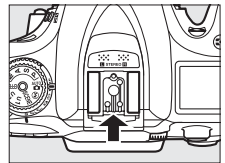

The AS-15 Sync Terminal Adapter

When the AS-15 sync terminal adapter (available separately) is mounted on the camera accessory shoe, flash accessories can be connected via a sync terminal.

Use Only Nikon Flash Accessories

Use only Nikon flash units. Negative voltages or voltages over 250 V applied to the accessory shoe could not only prevent normal operation, but damage the sync circuitry of the camera or flash. Before using a Nikon flash unit not listed in this section, contact a Nikon-authorized service representative for more information.



The Nikon Creative Lighting System (CLS)

Nikon's advanced Creative Lighting System (CLS) offers improved communication between the camera and compatible flash units for improved flash photography. Refer to the documentation provided with the flash unit for details.

■ ■ CLS-Compatible Flash Units

The camera can be used with the following CLS-compatible flash units:

- **The SB-910, SB-900, SB-800, SB-700, SB-600, SB-400, and SB-R200:**

Flash unit		Flash unit						
		SB-910 ¹	SB-900 ¹	SB-800	SB-700 ¹	SB-600	SB-400 ²	SB-R200 ³
Feature	ISO 100	34/111	34/111	38/125	28/92	30/98	21/69	10/33
	ISO 200	48/157	48/157	53/174	39/128	42/138	30/98	14/46

1 If a color filter is attached to the SB-910, SB-900, or SB-700 when AUTO or $\frac{1}{2}$ (flash) is selected for white balance, the camera will automatically detect the filter and adjust white balance appropriately.

2 Wireless flash control is not available with the SB-400.

3 Controlled remotely with built-in flash in commander mode or using optional SB-910, SB-900, SB-800, or SB-700 flash unit or SU-800 wireless Speedlight commander.

4 m/ft, 20 °C (68 °F), SB-910, SB-900, SB-800, SB-700, and SB-600 at 35 mm zoom head position; SB-910, SB-900, and SB-700 with standard illumination.

- **SU-800 Wireless Speedlight Commander:** When mounted on a CLS-compatible camera, the SU-800 can be used as a commander for remote SB-910, SB-900, SB-800, SB-700, SB-600, or SB-R200 flash units in up to three groups. The SU-800 itself is not equipped with a flash.

Guide Number

To calculate the range of the flash at full power, divide the Guide Number by the aperture. If, for example, the flash unit has a Guide Number of 34 m or 111 ft (ISO 100, 20 °C/68 °F); its range at an aperture of f/5.6 is $34 \div 5.6$ or about 6.1 meters (or in feet, $111 \div 5.6 =$ approximately 19 ft 10 in.). For each twofold increase in ISO sensitivity, multiply the Guide Number by the square root of two (approximately 1.4).

The following features are available with CLS-compatible flash units:

		CLS-compatible flash units									
		SB-910 SB-900	SB-800	SB-700	SB-600	SU-800		SB-R200	SB-400		
						Commander	Close-up photography				
Single flash	i-TTL	i-TTL balanced fill-flash for digital SLR ¹	✓	✓	✓	✓	—	—	—	✓	
		Standard i-TTL flash for digital SLR	✓ ²	✓ ²	✓	✓ ²	—	—	—	✓	
	AA	Auto aperture	✓ ³	✓ ³	—	—	—	—	—	—	
	A	Non-TTL auto	✓ ³	✓ ³	—	—	—	—	—	—	
	GN	Distance-priority manual	✓	✓	✓	—	—	—	—	—	
	M	Manual	✓	✓	✓	✓	—	—	—	✓ ⁴	
	RPT	Repeating flash	✓	✓	—	—	—	—	—	—	
Advanced Wireless Lighting	Master	Remote flash control	✓	✓	✓	—	✓	✓	—	—	
		i-TTL	i-TTL	✓	✓	✓	—	—	—	—	
		[A:B]	Quick wireless flash control	—	—	✓	—	—	✓	—	—
		AA	Auto aperture	✓ ⁵	✓ ⁵	—	—	—	—	—	—
		A	Non-TTL auto	✓	✓	—	—	—	—	—	—
		M	Manual	✓	✓	✓	—	—	—	—	—
		RPT	Repeating flash	✓	✓	—	—	—	—	—	
	Remote	i-TTL	i-TTL	✓	✓	✓	✓	—	—	✓	—
		[A:B]	Quick wireless flash control	✓	✓	✓	✓	—	—	✓	—
		AA	Auto aperture	✓ ⁵	✓ ⁵	—	—	—	—	—	—
		A	Non-TTL auto	✓	✓	—	—	—	—	—	—
		M	Manual	✓	✓	✓	✓	—	—	✓	—
			RPT	Repeating flash	✓	✓	✓	✓	—	—	—
	Flash Color Information Communication		✓	✓	✓	✓	—	—	—	—	✓
Auto FP High-Speed Sync ⁶		✓	✓	✓	✓	✓	✓	✓	✓	—	
FV lock ⁷		✓	✓	✓	✓	✓	✓	✓	✓	✓	
AF-assist for multi-area AF		✓	✓	✓	✓	✓	—	—	—	—	
Red-eye reduction		✓	✓	✓	✓	—	—	—	—	✓	
Camera modeling illumination		✓	✓	✓	✓	✓	✓	✓	—	—	
Camera flash mode selection		—	—	—	—	—	—	—	—	✓	
Camera flash unit firmware update		✓	—	✓	—	—	—	—	—	—	

1 Not available with spot metering.

2 Can also be selected with flash unit.

3 AA/A mode selection performed on flash unit using custom settings. A is selected when a non-CPU lens is used.

4 Can only be selected with camera (□ 247).

5 When a non-CPU lens is used, non-TTL auto (A) is used regardless of mode selected with flash unit.

6 Available only in i-TTL, AA, A, GN, and M flash-control modes.

7 Available only in i-TTL, AA, and A flash-control modes.

Auto Aperture/Non-TTL Auto

Unless the focal length and maximum aperture are specified using the **Non-CPU lens data** option in the setup menu, choosing auto aperture (AA) when a non-CPU lens is attached automatically selects non-TTL auto (A).



■ ■ Other Flash Units

The following flash units can be used in non-TTL auto and manual modes.

Flash mode \ Flash unit	SB-80DX, SB-28DX, SB-28, SB-26, SB-25, SB-24	SB-50DX ¹	SB-30, SB-27 ² , SB-22S, SB-22, SB-20, SB-16B, SB-15	SB-23, SB-29 ³ , SB-21B ³ , SB-29S ³
A Non-TTL auto	✓	—	✓	—
M Manual	✓	✓	✓	✓
 Repeating flash	✓	—	—	—
REAR Rear-curtain sync ⁴	✓	✓	✓	✓

1 Select mode **P**, **S**, **A**, or **M**, lower built-in flash, and use optional flash unit only.











2 Flash mode is automatically set to TTL and shutter-release is disabled. Set flash unit to A (non-TTL auto flash).

3 Autofocus is available with AF-S VR Micro-Nikkor 105mm f/2.8G IF-ED and AF-S Micro NIKKOR 60mm f/2.8G ED lenses only.

4 Available when camera is used to select flash mode.

Flash Control Mode

The information display shows the flash control mode for optional flash units attached to the camera accessory shoe as follows:

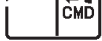
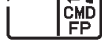
	Flash sync	Auto FP (📖 244)
i-TTL		
Auto aperture (AA)		
Non-TTL auto flash (A)		
Distance-priority manual (GN)		
Manual		
Repeating flash		—
Advanced wireless lighting		

Notes on Optional Flash Units

Refer to the Speedlight manual for detailed instructions. If the flash unit supports CLS, refer to the section on CLS-compatible digital SLR cameras. The D7100 is not included in the “digital SLR” category in the SB-80DX, SB-28DX, and SB-50DX manuals.

If an optional flash unit is attached in shooting modes other than \odot , \square , and P , the flash will fire with every shot, even in modes in which the built-in flash can not be used.

i-TTL flash control can be used at ISO sensitivities between 100 and 6400. At values over 6400, the desired results may not be achieved at some ranges or aperture settings. If the flash-ready indicator flashes for about three seconds after a photograph is taken, the flash has fired at full power and the photograph may be underexposed.

When an SC-series 17, 28, or 29 sync cable is used for off-camera flash photography, correct exposure may not be achieved in i-TTL mode. We recommend that you select standard i-TTL flash control. Take a test shot and view the results in the monitor.

In i-TTL, use the flash panel or bounce adapter provided with the flash unit. Do not use other panels such as diffusion panels, as this may produce incorrect exposure.

The SB-910, SB-900, SB-800, SB-700, SB-600, and SB-400 provide red-eye reduction, while the SB-910, SB-900, SB-800, SB-700, SB-600, and SU-800 provide AF-assist illumination with the following restrictions:

- **SB-910 and SB-900:** AF-assist illumination is available with 17–135 mm AF lenses, however, autofocus is available only with the focus points shown at right.

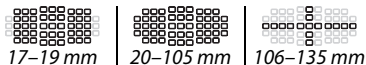

- **SB-800, SB-600, and SU-800:** AF-assist illumination is available with 24–105 mm AF lenses, however, autofocus is available only with the focus points shown at right.

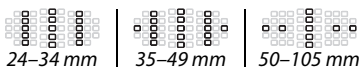

- **SB-700:** AF-assist illumination is available with 24–135 mm AF lenses, however, autofocus is available only with the focus points shown at right.



In mode **P**, the maximum aperture (minimum f-number) is limited according to ISO sensitivity, as shown below:

Maximum aperture at ISO equivalent of:						
100	200	400	800	1600	3200	6400
4	5	5.6	7.1	8	10	11

If the maximum aperture of the lens is smaller than given above, the maximum value for aperture will be the maximum aperture of the lens.



Other Accessories

At the time of writing, the following accessories were available for the D7100.

Power sources	<ul style="list-style-type: none">• Rechargeable Li-ion Battery EN-EL15 (☞ 22, 24): Additional EN-EL15 batteries are available from local retailers and Nikon-authorized service representatives.• Battery Charger MH-25 (☞ 22): Recharge EN-EL15 batteries.• Multi-Power Battery Pack MB-D15: The MB-D15 is equipped with a shutter-release button, AE/AF lock button, multi selector, and main- and sub-command dials for improved operation when taking photographs in portrait (tall) orientation. When attaching the MB-D15, remove the camera MB-D15 contact cover.• Power Connector EP-5B, AC Adapter EH-5b: These accessories can be used to power the camera for extended periods (EH-5a and EH-5 AC adapters can also be used). The EP-5B is required to connect the camera to the EH-5b; see page 311 for details. Note that when the camera is used with an MB-D15, the EP-5B must be inserted into the MB-D15, not the camera. Do not attempt to use the camera with power connectors inserted into both the camera and MB-D15.
Filters	<ul style="list-style-type: none">• Filters intended for special-effects photography may interfere with autofocus or the electronic rangefinder.• Use C-PL or C-PL II circular polarizing filters. Polar-brand linear polarizing filters can not be used.• Use NC filters to protect the lens.• To prevent ghosting, use of a filter is not recommended when the subject is framed against a bright light, or when a bright light source is in the frame.• Center-weighted metering is recommended with filters with exposure factors (filter factors) over $1\times$ (Y44, Y48, Y52, O56, R60, X0, X1, C-PL/C-PL II, ND2S, ND4, ND4S, ND8, ND8S, ND400, A2, A12, B2, B8, B12). See the filter manual for details.
Viewfinder eyepiece accessories	<ul style="list-style-type: none">• DK-20C Eyepiece Correction Lenses: Lenses are available with diopters of -5, -4, -3, -2, 0, $+0.5$, $+1$, $+2$, and $+3\text{ m}^{-1}$ when the camera diopter adjustment control is in the neutral position (-1 m^{-1}). Use eyepiece correction lenses only if the desired focus can not be achieved with the built in diopter adjustment control (-2 to $+1\text{ m}^{-1}$). Test eyepiece correction lenses before purchase to ensure that the desired focus can be achieved. The rubber eyecup can not be used with eyepiece correction lenses.• Magnifying Eyepiece DK-21M: The DK-21M magnifies the view through the viewfinder by approximately $1.17\times$ (50 mm f/1.4 lens at infinity; -1.0 m^{-1}) for greater precision when framing.• Magnifier DG-2: The DG-2 magnifies the scene displayed in the center of the viewfinder for greater precision during focusing. Eyepiece adapter required (available separately).• Eyepiece Adapter DK-22: The DK-22 is used when attaching the DG-2 magnifier.• Right-Angle Viewing Attachment DR-6: The DR-6 attaches at a right angle to the viewfinder eyepiece, allowing the image in the viewfinder to be viewed at right angles to the lens (for example, from directly above when the camera is horizontal).

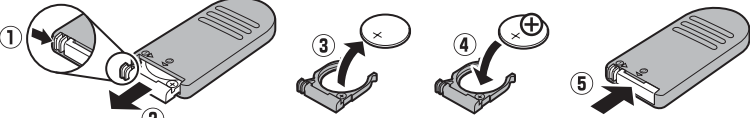
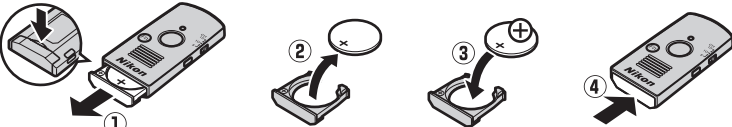

<p>Software</p>	<ul style="list-style-type: none"> • Capture NX 2: A complete photo editing package with such advanced editing features as selection control points and an auto retouch brush. • Camera Control Pro 2: Control the camera remotely from a computer to record movies and photographs and save photographs directly to the computer hard disk. <p>Note: Use the latest versions of Nikon software; see the websites listed on page xxvi for the latest information on supported operating systems. At default settings, Nikon Message Center 2 will periodically check for updates to Nikon software and firmware while you are logged in to an account on the computer and the computer is connected to the Internet. A message is automatically displayed when an update is found.</p>
<p>Body cap</p>	<p>Body Cap BF-1B/Body Cap BF-1A: The body cap keeps the mirror, viewfinder screen, and image sensor free of dust when a lens is not in place.</p>
<p>Remote controls/ wireless remote controllers</p>	<ul style="list-style-type: none"> • Wireless Remote Control ML-L3 (☐ 127): The ML-L3 uses a 3 V CR2025 battery.  <p>Pressing the battery-chamber latch to the right (①), insert a fingernail into the gap and open the battery chamber (②). Ensure that the battery is inserted in the correct orientation (④).</p> <ul style="list-style-type: none"> • Wireless Remote Controller WR-R10/WR-T10 (☐ 130): When a WR-R10 wireless remote controller is attached, the camera can be controlled wirelessly using a WR-T10 wireless remote controller. The WR-T10 uses a 3 V CR2032 battery.  <p>Insert a fingernail into the gap behind the battery-chamber latch and open the battery chamber (①). Ensure that the battery is inserted in the correct orientation (③).</p> <ul style="list-style-type: none"> • Wireless Remote Controller WR-1 (☐ 130): WR-1 units are used in groups of two or more, with one functioning as a transmitter and the remaining units acting receivers. The receivers are attached to the accessory terminals of one or more cameras, allowing the transmitter to be used to release the camera shutters or adjust settings remotely.

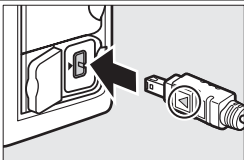

LAN adapters (☐ 206)	<ul style="list-style-type: none"> • Communication Unit UT-1 (☐ 206): When connected to the camera using the USB cable supplied with the camera, the UT-1 can be used to connect to Ethernet networks and upload pictures to an ftp server or control the camera remotely using optional Camera Control Pro 2 software. Note that the UT-1 requires its own power source; use an optional EN-EL15 rechargeable Li-ion battery or an EP-5B power connector and EH-5b AC adapter. • Wireless Transmitter WT-5: Use in combination with a UT-1 to connect to wireless networks. <p>Use of the UT-1 and WT-5 requires a wireless or Ethernet network and knowledge of how to use it. Always use the latest version of the software supplied with the devices.</p>
Wireless mobile adapters	<p>Wireless Mobile Adapter WU-1a: Supports two-way communication between the camera and smart devices running the Wireless Mobile Utility.</p>
Accessory terminal accessories	<p>The D7100 is equipped with an accessory terminal for WR-1 and WR-R10 wireless remote controllers (☐ 130), MC-DC2 remote cords (☐ 52) and GP-1 GPS units (☐ 152), which connect with the ◀ mark on the connector aligned with the ▶ next to the accessory terminal (close the camera connector cover when the terminal is not in use).</p> 
Microphones	<p>Stereo Microphone ME-1 (☐ 165)</p>



Attaching a Power Connector and AC Adapter

Turn the camera off before attaching an optional power connector and AC adapter.

1 Ready the camera.

Open the battery-chamber (1) and power connector (2) covers.

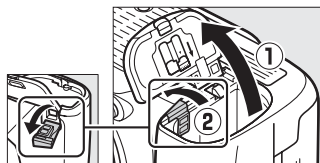

2 Insert the EP-5B power connector.

Be sure to insert the connector in the orientation shown, using the connector to keep the orange battery latch pressed to one side. The latch locks the connector in place when the connector is fully inserted.

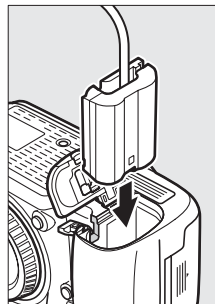

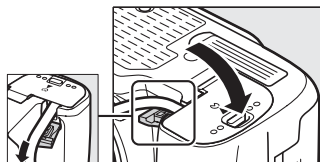

3 Close the battery-chamber cover.

Position the power connector cable so that it passes through the power connector slot and close the battery-chamber cover.



4 Connect the AC adapter.

Connect the AC adapter power cable to the AC socket on AC adapter (3) and the EP-5B power cable to the DC socket (4). When the camera is powered by the AC adapter and power connector,  replaces the  icon.

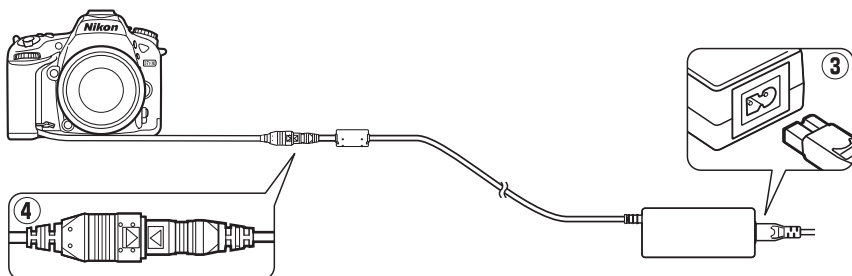

Caring for the Camera

Storage

When the camera will not be used for an extended period, remove the battery and store the battery in a cool, dry area with the terminal cover in place. To prevent mold or mildew, store the camera in a dry, well-ventilated area. Do not store your camera with naphtha or camphor moth balls or in locations that:

- are poorly ventilated or subject to humidities of over 60%
- are next to equipment that produces strong electromagnetic fields, such as televisions or radios
- are exposed to temperatures above 50 °C (122 °F) or below –10 °C (14 °F)

Cleaning

Camera body	Use a blower to remove dust and lint, then wipe gently with a soft, dry cloth. After using the camera at the beach or seaside, wipe off sand or salt with a cloth lightly dampened in distilled water and dry thoroughly. Important: <i>Dust or other foreign matter inside the camera may cause damage not covered under warranty.</i>
Lens, mirror, and viewfinder	These glass elements are easily damaged. Remove dust and lint with a blower. To remove fingerprints and other stains, apply a small amount of lens cleaner to a soft cloth and clean with care.
Monitor	Remove dust and lint with a blower. When removing fingerprints and other stains, wipe the surface lightly with a soft cloth or chamois leather. Do not apply pressure, as this could result in damage or malfunction.

Do not use alcohol, thinner, or other volatile chemicals.

Servicing the Camera and Accessories

The camera is a precision device and requires regular servicing. Nikon recommends that the camera be inspected by the original retailer or Nikon-authorized service representative once every one to two years, and that it be serviced once every three to five years (note that fees apply to these services). Frequent inspection and servicing are particularly recommended if the camera is used professionally. Any accessories regularly used with the camera, such as lenses or optional Speedlights, should be included when the camera is inspected or serviced.

Image Sensor Cleaning

If you suspect that dirt or dust on the image sensor is appearing in photographs, you can clean the sensor using the **Clean image sensor** option in the setup menu. The sensor can be cleaned at any time using the **Clean now** option, or cleaning can be performed automatically when the camera is turned on or off.

■ "Clean Now"

1 Select Clean image sensor in the setup menu.

Press the **MENU** button to display the menus. Highlight **Clean image sensor** in the setup menu and press **▶**.

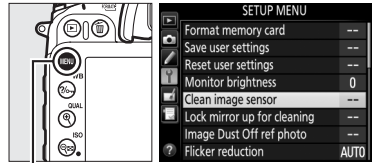

MENU button

2 Select Clean now.

Highlight **Clean now** and press **OK**. The camera will check the image sensor and then begin cleaning. During this time, **bwSY** flashes in the control panel and other operations can not be performed. Do not remove or disconnect the power source until cleaning is complete and **bwSY** is no longer displayed.



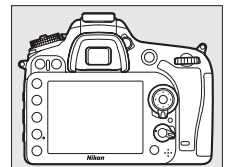

🔍 Place the Camera Base Down

Image sensor cleaning is most effective when the camera is placed base down as shown at right.



■ ■ “Clean at Startup/Shutdown”

Choose from the following options:

Option	Description
 Clean at startup	The image sensor is automatically cleaned each time the camera is turned on.
 Clean at shutdown	The image sensor is automatically cleaned during shutdown each time the camera is turned off.
 Clean at startup & shutdown	The image sensor is cleaned automatically at startup and at shutdown.
Cleaning off	Automatic image sensor cleaning off.

1 Select Clean at startup/shutdown.

Display the **Clean image sensor** menu as described in Step 2 on the previous page. Highlight **Clean at startup/shutdown** and press ►.

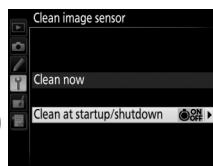

2 Select an option.

Highlight an option and press .

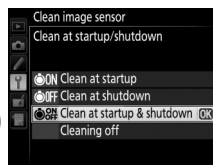

Image Sensor Cleaning

Using camera controls during startup interrupts image sensor cleaning. Image sensor cleaning may not be performed at startup if the flash is charging.

If dust can not be fully removed using the options in the **Clean image sensor** menu, clean the image sensor manually (□ 315) or consult a Nikon-authorized service representative.

If image sensor cleaning is performed several times in succession, image sensor cleaning may be temporarily disabled to protect the camera's internal circuitry. Cleaning can be performed again after a short wait.

Manual Cleaning

If foreign matter can not be removed from the image sensor using the **Clean image sensor** option in the setup menu (☰ 313), the sensor can be cleaned manually as described below. Note, however, that the sensor is extremely delicate and easily damaged. Nikon recommends that the sensor be cleaned only by Nikon-authorized service personnel.

1 Charge the battery or connect an AC adapter.

A reliable power source is required when inspecting or cleaning the image sensor. Turn the camera off and insert a fully-charged EN-EL15 battery or connect an optional EP-5B power connector and EH-5b AC adapter. The **Lock mirror up for cleaning** option is only available in the setup menu at battery levels over .

2 Remove the lens.

Turn the camera off and remove the lens.

3 Select Lock mirror up for cleaning.

Turn the camera on and press the MENU button to display the menus. Highlight **Lock mirror up for cleaning** in the setup menu and press ►.



MENU button

4 Press .

The message shown at right will be displayed in the monitor and a row of dashes will appear in the control panel and viewfinder. To restore normal operation without inspecting the image sensor, turn the camera off.

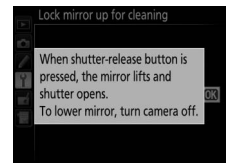

5 Raise the mirror.

Press the shutter-release button all the way down. The mirror will be raised and the shutter curtain will open, revealing the image sensor. The display in the viewfinder will turn off and the row of dashes in the control panel will flash.

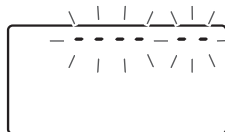

6 Examine the image sensor.

Holding the camera so that light falls on the image sensor, examine the sensor for dust or lint. If no foreign objects are present, proceed to Step 8.

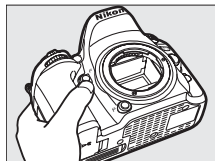

7 Clean the sensor.

Remove any dust and lint from the sensor with a blower. Do not use a blower-brush, as the bristles could damage the sensor. Dirt that can not be removed with a blower can only be removed by Nikon-authorized service personnel. Under no circumstances should you touch or wipe the sensor.

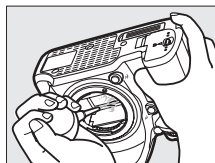

8 Turn the camera off.

The mirror will return to the down position and the shutter curtain will close. Replace the lens or body cap.

Use a Reliable Power Source

The shutter curtain is delicate and easily damaged. If the camera powers off while the mirror is raised, the curtain will close automatically. To prevent damage to the curtain, observe the following precautions:

- Do not turn the camera off or remove or disconnect the power source while the mirror is raised.
- If the battery runs low while the mirror is raised, a beep will sound and the self-timer lamp will flash to warn that the shutter curtain will close and the mirror will be lowered after about two minutes. End cleaning or inspection immediately.

Foreign Matter on the Image Sensor

Nikon takes every possible precaution to prevent foreign matter from coming into contact with the image sensor during production and shipping. The D7100, however, is designed to be used with interchangeable lenses, and foreign matter may enter the camera when lenses are removed or exchanged. Once inside the camera, this foreign matter may adhere to the image sensor, where it may appear in photographs taken under certain conditions. To protect the camera when no lens is in place, be sure to replace the body cap provided with the camera, being careful to first remove all dust and other foreign matter that may be adhering to the body cap. Avoid exchanging lenses in dusty environments.

Should foreign matter find its way onto the image sensor, clean the sensor as described above, or have the sensor cleaned by authorized Nikon service personnel. Photographs affected by the presence of foreign matter on the sensor can be retouched using Capture NX 2 (available separately; ☐ 309) or the clean image options available in some third-party imaging applications.



Caring for the Camera and Battery: Cautions

Do not drop: The product may malfunction if subjected to strong shocks or vibration.

Keep dry: This product is not waterproof, and may malfunction if immersed in water or exposed to high levels of humidity. Rusting of the internal mechanism can cause irreparable damage.

Avoid sudden changes in temperature: Sudden changes in temperature, such as those that occur when entering or leaving a heated building on a cold day, can cause condensation inside the device. To prevent condensation, place the device in a carrying case or plastic bag before exposing it to sudden changes in temperature.

Keep away from strong magnetic fields: Do not use or store this device in the vicinity of equipment that generates strong electromagnetic radiation or magnetic fields. Strong static charges or the magnetic fields produced by equipment such as radio transmitters could interfere with the monitor, damage data stored on the memory card, or affect the product's internal circuitry.

Do not leave the lens pointed at the sun: Do not leave the lens pointed at the sun or other strong light source for an extended period. Intense light may cause the image sensor to deteriorate or produce a white blur effect in photographs.

Turn the product off before removing or disconnecting the power source: Do not unplug the product or remove the battery while the product is on or while images are being recorded or deleted. Forcibly cutting power in these circumstances could result in loss of data or in damage to product memory or internal circuitry. To prevent an accidental interruption of power, avoid carrying the product from one location to another while the AC adapter is connected.

Cleaning: When cleaning the camera body, use a blower to gently remove dust and lint, then wipe gently with a soft, dry cloth. After using the camera at the beach or seaside, wipe off any sand or salt using a cloth lightly dampened in pure water and then dry the camera thoroughly. In rare instances, static electricity may cause LCDs to light up or go dark. This does not indicate a malfunction, and the display will soon return to normal.

The lens and mirror are easily damaged. Dust and lint should be gently removed with a blower. When using an aerosol blower, keep the can vertical to prevent discharge of liquid. To remove fingerprints and other stains from the lens, apply a small amount of lens cleaner to a soft cloth and wipe the lens carefully.

See "Image Sensor Cleaning" (☐ 313, 315) for information on cleaning the image sensor.

Lens contacts: Keep the lens contacts clean.

Do not touch the shutter curtain: The shutter curtain is extremely thin and easily damaged. Under no circumstances should you exert pressure on the curtain, poke it with cleaning tools, or subject it to powerful air currents from a blower. These actions could scratch, deform, or tear the curtain.



Storage: To prevent mold or mildew, store the camera in a dry, well-ventilated area. If you are using an AC adapter, unplug the adapter to prevent fire. If the product will not be used for an extended period, remove the battery to prevent leakage and store the camera in a plastic bag containing a desiccant. Do not, however, store the camera case in a plastic bag, as this may cause the material to deteriorate. Note that desiccant gradually loses its capacity to absorb moisture and should be replaced at regular intervals.

To prevent mold or mildew, take the camera out of storage at least once a month. Turn the camera on and release the shutter a few times before putting it away.

Store the battery in a cool, dry place. Replace the terminal cover before putting the battery away.

Notes on the monitor: The monitor is constructed with extremely high precision; at least 99.99% of pixels are effective, with no more than 0.01% being missing or defective. Hence while these displays may contain pixels that are always lit (white, red, blue, or green) or always off (black), this is not a malfunction and has no effect on images recorded with the device.

Images in the monitor may be difficult to see in a bright light.

Do not apply pressure to the monitor, as this could cause damage or malfunction. Dust or lint on the monitor can be removed with a blower. Stains can be removed by wiping lightly with a soft cloth or chamois leather. Should the monitor break, care should be taken to avoid injury from broken glass and to prevent liquid crystal from the monitor touching the skin or entering the eyes and mouth.

Batteries: Batteries may leak or explode if improperly handled. Observe the following precautions when handling batteries:

- Use only batteries approved for use in this equipment.
- Do not expose the battery to flame or excessive heat.
- Keep the battery terminals clean.
- Turn the product off before replacing the battery.
- Remove the battery from the camera or charger when not in use and replace the terminal cover. These devices draw minute amounts of charge even when off and could draw the battery down to the point that it will no longer function. If the battery will not be used for some time, insert it in the camera and run it flat before removing it and storing it in a location with an ambient temperature of 15 °C to 25 °C (59 °F to 77 °F; avoid hot or extremely cold locations). Repeat this process at least once every six months.
- Turning the camera on or off repeatedly when the battery is fully discharged will shorten battery life. Batteries that have been fully discharged must be charged before use.
- The internal temperature of the battery may rise while the battery is in use. Attempting to charge the battery while the internal temperature is elevated will impair battery performance, and the battery may not charge or charge only partially. Wait for the battery to cool before charging.



- Continuing to charge the battery after it is fully charged can impair battery performance.
- A marked drop in the time a fully charged battery retains its charge when used at room temperature indicates that it requires replacement. Purchase a new EN-EL15 battery.
- Charge the battery before use. When taking photographs on important occasions, ready a spare EN-EL15 battery and keep it fully charged. Depending on your location, it may be difficult to purchase replacement batteries on short notice. Note that on cold days, the capacity of batteries tends to decrease. Be sure the battery is fully charged before taking photographs outside in cold weather. Keep a spare battery in a warm place and exchange the two as necessary. Once warmed, a cold battery may recover some of its charge.
- Used batteries are a valuable resource; recycle in accord with local regulations.



Available Settings

The following table lists the settings that can be adjusted in each mode.

Shooting menu	Storage folder	✓	✓	✓	✓	✓	✓	✓	✓	✓	✓	✓	
	File naming ¹	✓	✓	✓	✓	✓	✓	✓	✓	✓	✓	✓	
	Role played by card in Slot 2 ¹	✓	✓	✓	✓	✓	✓	✓	✓	✓	✓	✓	
	Image quality ^{1,2}	✓	✓	✓	✓	✓	✓	✓	✓	✓	✓	✓	
	Image size ^{1,2}	✓	✓	✓	✓	✓	✓	✓	✓	✓	✓	✓	
	Image area ¹	✓	✓	✓	✓	✓	✓	✓	✓	✓	✓	✓	
	JPEG compression ¹	✓	✓	✓	✓	✓	✓	✓	✓	✓	✓	✓	
	NEF (RAW) recording ¹	✓	✓	✓	✓	✓	✓	✓	✓	✓	✓	✓	
	White balance ^{1,2}	—	—	✓	✓	—	—	—	—	—	—	—	—
	Set Picture Control ^{1,2}	—	—	✓	✓	—	—	—	—	—	—	—	—
	Color space ¹	✓	✓	✓	✓	✓	✓	✓	✓	✓	✓	✓	✓
	Active D-Lighting ¹	— ³	— ³	✓	✓	— ³	— ³	— ³	— ³	—	—	—	—
	HDR (high dynamic range) ^{1,2}	—	—	✓	✓	—	—	—	—	—	—	—	—
	Auto distortion control ¹	✓	✓	✓	✓	✓	✓	✓	✓	✓	✓	✓	✓
	Long exposure NR ¹	✓	✓	✓	✓	✓	✓	✓	✓	—	✓	✓	✓
	High ISO NR ¹	✓	✓	✓	✓	✓	✓	✓	✓	—	✓	✓	✓
	ISO sensitivity settings ^{1,2}	✓ ⁴	✓ ⁴	✓	✓	✓ ⁴	✓ ⁴	✓ ⁴	✓ ⁴	—	✓ ⁴	✓ ⁴	✓ ⁴
	Remote control mode (ML-L3) ^{1,2}	✓	✓	✓	✓	✓	✓	✓	✓	✓	✓	✓	✓
	Multiple exposure ^{1,2}	—	—	✓	✓	—	—	—	—	—	—	—	—
	Interval timer shooting ¹	✓	✓	✓	✓	✓	✓	✓	✓	✓	✓	✓	✓
Movie settings ¹	✓	✓	✓	✓	✓	✓	✓	✓	✓	✓	✓	✓	
Other settings ²	Autofocus mode (viewfinder)	✓ ⁵	✓ ⁵	✓	✓	✓ ⁵	✓ ⁵	✓ ⁵	✓ ⁵	✓ ⁵	✓ ⁵	✓ ⁵	
	AF-area mode (viewfinder)	✓ ⁵	✓ ⁵	✓	✓	✓ ⁵	✓ ⁵	✓ ⁵	✓ ⁵	—	✓ ⁵	—	
	Autofocus mode (live view/movie)	✓	✓	✓	✓	✓	✓	✓	✓	✓	✓	✓	
	AF-area mode (live view/movie)	✓ ⁵	✓ ⁵	✓	✓	✓ ⁵	✓ ⁵	✓ ⁵	✓ ⁵	✓ ⁵	✓ ⁵	—	
	AE-L/AF-L button hold	✓ ⁵	✓ ⁵	✓	✓	✓ ⁵	✓ ⁵	✓ ⁵	✓ ⁵	✓ ⁵	✓ ⁵	✓ ⁵	
	Flexible program	—	—	✓	—	—	—	—	—	—	—	—	—
	Metering	—	—	✓	✓	—	—	—	—	—	—	—	—
	Exposure compensation	—	—	✓	✓	—	—	—	—	✓ ⁵	—	—	—
	Bracketing	—	—	✓	✓	—	—	—	—	—	—	—	—
	Flash mode	✓ ⁵	—	✓	✓	✓ ⁵	—	✓ ⁵	—	—	✓ ⁵	—	
Flash compensation	—	—	✓	✓	—	—	—	—	—	—	—		
FV lock	✓	—	✓	✓	✓	—	✓	—	—	✓	—		



a1: AF-C priority selection	✓	✓	✓	✓	✓	✓	✓	✓	✓	✓	✓	✓
a2: AF-S priority selection	✓	✓	✓	✓	✓	✓	✓	✓	✓	✓	✓	✓
a3: Focus tracking with lock-on	✓	✓	✓	✓	✓	✓	✓	✓	✓	✓	✓	✓
a4: AF point illumination	✓	✓	✓	✓	✓	✓	✓	✓	✓	✓	✓	✓
a5: Focus point wrap-around	✓	✓	✓	✓	✓	✓	✓	✓	✓	✓	✓	✓
a6: Number of focus points	✓	✓	✓	✓	✓	✓	✓	✓	✓	✓	✓	✓
a7: Built-in AF-assist illuminator	✓	✓	✓	✓	✓	—	—	✓	—	✓	—	✓
b1: ISO sensitivity step value	✓	✓	✓	✓	✓	✓	✓	✓	✓	✓	✓	✓
b2: EV steps for exposure cntl	✓	✓	✓	✓	✓	✓	✓	✓	✓	✓	✓	✓
b3: Easy exposure compensation	—	—	✓	✓	—	—	—	—	—	—	—	—
b4: Center-weighted area	—	—	✓	✓	—	—	—	—	—	—	—	—
b5: Fine-tune optimal exposure	✓	✓	✓	✓	✓	✓	✓	✓	✓	✓	✓	✓
c1: Shutter-release button AE-L	✓	✓	✓	✓	✓	✓	✓	✓	✓	✓	✓	✓
c2: Standby timer	✓	✓	✓	✓	✓	✓	✓	✓	✓	✓	✓	✓
c3: Self-timer	✓	✓	✓	✓	✓	✓	✓	✓	✓	✓	✓	✓
c4: Monitor off delay	✓	✓	✓	✓	✓	✓	✓	✓	✓	✓	✓	✓
c5: Remote on duration (ML-L3)	✓	✓	✓	✓	✓	✓	✓	✓	✓	✓	✓	✓
d1: Beep	✓	✓	✓	✓	✓	✓	✓	✓	✓	✓	✓	✓
d2: Viewfinder grid display	✓	✓	✓	✓	✓	✓	✓	✓	✓	✓	✓	✓
d3: ISO display and adjustment	✓	✓	✓	✓	✓	✓	✓	✓	✓	✓	✓	✓
d4: Screen tips	✓	✓	✓	✓	✓	✓	✓	✓	✓	✓	✓	✓
d5: CL mode shooting speed	✓	✓	✓	✓	✓	✓	✓	✓	✓	✓	✓	✓
d6: Max. continuous release	✓	✓	✓	✓	✓	✓	✓	✓	✓	✓	✓	✓
d7: File number sequence	✓	✓	✓	✓	✓	✓	✓	✓	✓	✓	✓	✓
d8: Information display	✓	✓	✓	✓	✓	✓	✓	✓	✓	✓	✓	✓
d9: LCD illumination	✓	✓	✓	✓	✓	✓	✓	✓	✓	✓	✓	✓
d10: Exposure delay mode ²	✓	✓	✓	✓	✓	✓	✓	✓	✓	✓	✓	✓
d11: Flash warning	—	—	✓	✓	—	—	—	—	—	—	—	—
d12: MB-D15 battery type	✓	✓	✓	✓	✓	✓	✓	✓	✓	✓	✓	✓
d13: Battery order	✓	✓	✓	✓	✓	✓	✓	✓	✓	✓	✓	✓

Custom Settings 6

e1: Flash sync speed	✓	✓	✓	✓	✓	✓	✓	✓	✓	✓	✓	✓	✓
e2: Flash shutter speed	—	—	✓	✓	—	—	—	—	—	—	—	—	—
e3: Flash cntrl for built-in flash/Optional flash	—	—	✓	✓	—	—	—	—	—	—	—	—	—
e4: Exposure comp. for flash	—	—	✓	✓	—	—	—	—	—	—	—	—	—
e5: Modeling flash	—	—	✓	✓	—	—	—	—	—	—	—	—	—
e6: Auto bracketing set	—	—	✓	✓	—	—	—	—	—	—	—	—	—
e7: Bracketing order	—	—	✓	✓	—	—	—	—	—	—	—	—	—
Custom Settings ⁶ f1: OK button	✓	✓	✓	✓	✓	✓	✓	✓	✓	✓	✓	✓	✓
f2: Assign Fn button	✓	✓	✓	✓	✓	✓	✓	✓	✓	✓	✓	✓	✓
f3: Assign preview button	✓	✓	✓	✓	✓	✓	✓	✓	✓	✓	✓	✓	✓
f4: Assign AE-L/AF-L button	✓	✓	✓	✓	✓	✓	✓	✓	✓	✓	✓	✓	✓
f5: Customize command dials	✓	✓	✓	✓	✓	✓	✓	✓	✓	✓	✓	✓	✓
f6: Release button to use dial	✓	✓	✓	✓	✓	✓	✓	✓	✓	✓	✓	✓	✓
f7: Slot empty release lock	✓	✓	✓	✓	✓	✓	✓	✓	✓	✓	✓	✓	✓
f8: Reverse indicators	✓	✓	✓	✓	✓	✓	✓	✓	✓	✓	✓	✓	✓
f9: Assign MB-D15 button	✓	✓	✓	✓	✓	✓	✓	✓	✓	✓	✓	✓	✓
g1: Assign Fn button	✓	✓	✓	✓	✓	✓	✓	✓	✓	✓	✓	✓	✓
g2: Assign preview button	✓	✓	✓	✓	✓	✓	✓	✓	✓	✓	✓	✓	✓
g3: Assign AE-L/AF-L button	✓	✓	✓	✓	✓	✓	✓	✓	✓	✓	✓	✓	✓
g4: Assign shutter button	✓	✓	✓	✓	✓	✓	✓	✓	✓	✓	✓	✓	✓

- 1 Reset with **Reset shooting menu** (□ 224).
- 2 Reset with two-button reset (□ 131). Individual settings for multiple exposure are unaffected.
- 3 Fixed at **Auto**.
- 4 **Auto ISO sensitivity control** is not available.
- 5 Reset when mode dial is rotated to new setting.
- 6 Reset with **Reset custom settings** (□ 231).



Defaults

The default settings for the options in the camera menus are listed below. For information on two-button resets, see page 131.

■ Playback Menu Defaults

Option	Default	☐
Playback folder	D7100	217
Image review	Off	222
After delete	Show next	222
Rotate tall	On	222

Option	Default	☐
Slide show		
Image type	Still images and movies	223
Frame interval	2 s	

■ Shooting Menu Defaults¹

Option	Default	☐
File naming	DSC	226
Role played by card in Slot 2	Overflow	69
Image quality	JPEG normal	66
Image size	Large	68
Image area	DX (24×16)	64
JPEG compression	Size priority	67

NEF (RAW) recording

Type	Lossless compressed	67
NEF (RAW) bit depth	14-bit	

White balance	Auto > Normal	89
---------------	---------------	----

Fine-tuning	A-B: 0, G-M: 0	91
-------------	----------------	----







Choose color temp.	5000 K	94
--------------------	--------	----

Preset manual	d-1	95
---------------	-----	----

Set Picture Control	Standard	105
---------------------	----------	-----

Color space	sRGB	227
-------------	------	-----

Active D-Lighting

P, S, A, M ,  ,  ,  ,  ,  ,  , 	Off	113
Other modes	Auto	

HDR (high dynamic range)

HDR mode	Off	115
----------	-----	-----

HDR strength	Auto	116
--------------	------	-----

Option	Default	☐
Auto distortion control	Off	227
Long exposure NR	Off	228
High ISO NR	Normal	228

ISO sensitivity settings

ISO sensitivity		
-----------------	--	--

P, S, A, M	100	79
Other modes	Auto	

Auto ISO sensitivity control	Off	81
------------------------------	-----	----

Remote control mode (ML-L3)	Off	127
-----------------------------	-----	-----

Multiple exposure²

Multiple exposure mode	Off	141
------------------------	-----	-----

Number of shots	2	142
-----------------	---	-----

Auto gain	On	143
-----------	----	-----

Interval timer shooting	Reset ³	145
-------------------------	--------------------	-----

Movie settings

Frame size/frame rate	1920×1080; 30p	169
Movie quality	High quality	
Microphone	Auto sensitivity	
Destination	Slot 1	



1 Default settings restored with **Reset shooting menu** (☐ 224).

2 **Reset shooting menu** can not be selected while shooting is in progress.

3 Start time reset to **Now**, interval reset to 1 minute, number of intervals and number of shots reset to 1, and **Start** set to **Off**. Shooting ends when reset is performed.

■ Custom Settings Menu Defaults *

Option	Default	
a1	AF-C priority selection	Release 231
a2	AF-S priority selection	Focus 231
a3	Focus tracking with lock-on	3 (Normal) 232
a4	AF point illumination	Auto 232
a5	Focus point wrap-around	No wrap 232
a6	Number of focus points	51 points 233
a7	Built-in AF-assist illuminator	On 233
b1	ISO sensitivity step value	1/3 step 234
b2	EV steps for exposure cntl	1/3 step 234
b3	Easy exposure compensation	Off 235
b4	Center-weighted area	ø 8 mm 236
b5	Fine-tune optimal exposure	
	Matrix metering	0 236
	Center-weighted metering	0
	Spot metering	0
c1	Shutter-release button AE-L	Off 236
c2	Standby timer	6 s 237
c3	Self-timer	
	Self-timer delay	10 s 237
	Number of shots	1
	Interval between shots	0.5 s
c4	Monitor off delay	
	Playback	10 s 238
	Menus	1 min
	Information display	10 s
	Image review	4 s
	Live view	10 min
c5	Remote on duration (ML-L3)	1 min 238
d1	Beep	
	Volume	Off 238
	Pitch	Low
d2	Viewfinder grid display	Off 239
d3	ISO display and adjustment	Show frame count 239
d4	Screen tips	On 239
d5	CL mode shooting speed	3 fps 239
d6	Max. continuous release	100 240
d7	File number sequence	On 240
d8	Information display	Auto 241
d9	LCD illumination	Off 241
d10	Exposure delay mode	Off 241
d11	Flash warning	On 241

Option	Default	
d12	MB-D15 battery type	LR6 (AA alkaline) 242
d13	Battery order	Use MB-D15 batteries first 243
e1	Flash sync speed	1/250 s 244
e2	Flash shutter speed	1/60 s 245
e3	Flash cntl for built-in flash/ Optional flash	TTL 246
e4	Exposure comp. for flash	Entire frame 250
e5	Modeling flash	On 251
e6	Auto bracketing set	AE & flash 251
e7	Bracketing order	MTR > under > over 251
f1	OK button	
	Shooting mode	Select center focus point 252
	Playback mode	Thumbnail on/off 252
	Live view	Select center focus point 252
f2	Assign Fn button	
	Press	None 253
	Press + command dials	Choose image area 255
f3	Assign preview button	
	Press	Preview 255
	Press + command dials	None 255
f4	Assign AE-L/AF-L button	
	Press	AE/AF lock 256
	Press + command dials	None 256
f5	Customize command dials	
	Reverse rotation	Exposure compensation: <input type="checkbox"/> Shutter speed/aperture: <input type="checkbox"/> 257
	Change main/sub	Off
	Aperture setting	Sub-command dial
	Menus and playback	Off
f6	Release button to use dial	No 258
f7	Slot empty release lock	Enable release 258
f8	Reverse indicators	 258
f9	Assign MB-D15  button	AE/AF lock 259
g1	Assign Fn button	None 259
g2	Assign preview button	None 260
g3	Assign AE-L/AF-L button	AE/AF lock 260
g4	Assign shutter button	Take photos 260

* Default settings restored with **Reset custom settings** ( 231).

■ ■ Setup Menu Defaults

Option	Default	
Save user settings		
Save to U1	Shooting mode defaults to P	55
Save to U2		
Monitor brightness	0	262
Clean image sensor		
Clean at startup/shutdown	Clean at startup & shutdown	313
Flicker reduction	Auto	264
Time zone and date		
Daylight saving time	Off	265

Option	Default	
Auto image rotation	On	265
HDMI		
Output resolution	Auto	216
Device control	On	
GPS		
Standby timer	Enable	152
Use GPS to set camera clock	Yes	
Wireless mobile adapter	Enable	271
Eye-Fi upload	Enable	272



Exposure Program (Mode P)

The exposure program for mode **P** is shown in the following graph:

— ISO 100; lens with maximum aperture of f/1.4 and minimum aperture of f/16 (e.g., AF-S NIKKOR 50mm f/1.4G)

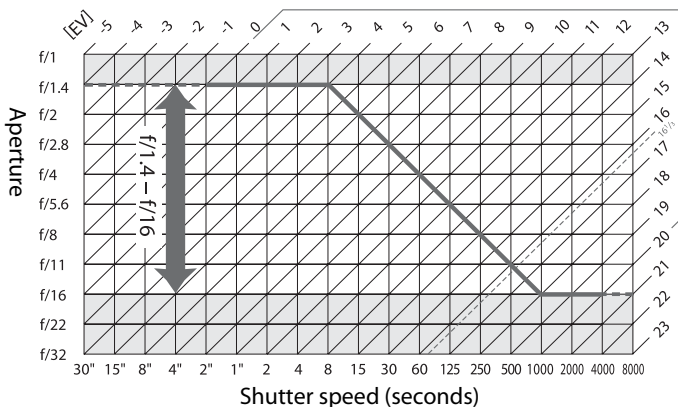

The maximum and minimum values for EV vary with ISO sensitivity; the above graph assumes an ISO sensitivity of ISO 100 equivalent. When matrix metering is used, values over $16^{1/3}$ EV are reduced to $16^{1/3}$ EV.



Troubleshooting

If the camera fails to function as expected, check the list of common problems below before consulting your retailer or Nikon-authorized service representative.

Battery/Display

The camera is on but does not respond: Wait for recording to end. If the problem persists, turn the camera off. If the camera does not turn off, remove and reinsert the battery or, if you are using an AC adapter, disconnect and reconnect the AC adapter. Note that although any data currently being recorded will be lost, data that have already been recorded will not be affected by removing or disconnecting the power source.

Viewfinder is out of focus: Adjust viewfinder focus or use optional eyepiece correction lenses (□ 33, 308).

Viewfinder is dark: Insert a fully-charged battery (□ 22, 35).

Displays turn off without warning: Choose longer delays for Custom Setting c2 (**Standby timer**) or c4 (**Monitor off delay**) (□ 237, 238).

Control panel and viewfinder displays are unresponsive and dim: The response times and brightness of these displays vary with temperature.

Fine lines are visible around active focus point or display turns red when focus point is highlighted: These phenomena are normal for this type of viewfinder and do not indicate a malfunction.

Shooting (All Modes)

Camera takes time to turn on: Delete files or folders.

Shutter-release disabled:

- Memory card is locked, full, or not inserted (□ 30, 31).
- **Release locked** is selected for Custom Setting f7 (**Slot empty release lock**; □ 258) and no memory card is inserted (□ 30).
- Built-in flash is charging (□ 38).
- Camera is not in focus (□ 37).
- CPU lens with aperture ring attached but aperture not locked at highest f-number. If **fE E** is displayed in control panel, select **Aperture ring** for Custom Setting f5 (**Customize command dials**) > **Aperture setting** to use lens aperture ring to adjust aperture (□ 257).
- Non-CPU lens is attached but camera is not in mode **A** or **M** (□ 298).

Camera is slow to respond to shutter-release button: Select **Off** for Custom Setting d10 (**Exposure delay mode**; □ 241).

No photo taken when remote control shutter-release button is pressed:

- Replace battery in remote control (□ 309).
- Choose an option other than **Off** for **Remote control mode (ML-L3)** (□ 127).
- Flash is charging (□ 38).
- Time selected for Custom Setting c5 (**Remote on duration (ML-L3)**; □ 238) has elapsed.
- Bright light is interfering with ML-L3 remote.



Photos are out of focus:

- Rotate focus-mode selector to **AF** (□ 71).
- Camera unable to focus using autofocus: use manual focus or focus lock (□ 76, 78).
- The shutter-release button can not be used to focus when **AF-ON** is assigned as the **Press** option for Custom Setting f2 (**Assign Fn button**, □ 253), f3 (**Assign preview button**, □ 255), f4 (**Assign AE-L/AF-L button**, □ 256), or f9 (**Assign MB-D15**  **button**, □ 259). Use the button to which **AF-ON** is assigned.

Focus does not lock when shutter-release button is pressed halfway: Use ^{AE-L}**AE-L/AF-L** button to lock focus when **AF-C** is selected for autofocus mode or when photographing moving subjects in **AF-A** mode.

Can not select focus point:

- Unlock focus selector lock (□ 75).
- Auto-area AF or face-priority AF selected for AF-area mode: choose another mode.
- Camera is in playback mode (□ 185) or menus are in use (□ 217).
- Press shutter-release button halfway to turn monitor off or start standby timer (□ 38).

Can not select AF-area mode: Manual focus selected (□ 78, 159).

Only one shot taken each time shutter-release button is pressed in continuous release mode: Continuous shooting is not available if built-in flash fires (□ 121).

Image size can not be changed: **Image quality** set to **NEF (RAW)** (□ 67).

Camera is slow to record photos: Turn long exposure noise reduction off (□ 228).

Noise (bright spots, randomly-spaced bright pixels, fog, or lines) appear in photos:

- Choose lower ISO sensitivity or use high ISO noise reduction (□ 79, 228).
- Shutter speed is slower than 1 s: use long exposure noise reduction (□ 228).
- Turn Active D-Lighting off to avoid heightening the effects of noise (□ 113).

AF-assist illuminator does not light:

- AF-assist lamp does not light if **AF-C** is selected for autofocus mode (□ 71) or if continuous-servo autofocus is selected when the camera is in **AF-A** mode. Choose **AF-S**. If single-point or dynamic-area AF is selected for AF-area mode, select center focus point (□ 73, 75).
- The camera is currently in live view or a movie is being recorded.
- **Off** selected for Custom Setting a7 (**Built-in AF-assist illuminator**) (□ 233).
- Illuminator has turned off automatically. Illuminator may become hot with continued use; wait for lamp to cool down.

Smudges appear in photographs: Clean front and rear lens elements. If problem persists, perform image sensor cleaning (□ 313).

Sound is not recorded with movies: **Microphone off** is selected for **Movie settings > Microphone**.

The brightness of the image in the monitor differs from the exposure of photographs taken in live view:

- Center-weighted or spot metering is selected (□ 83).
 - The camera is in mode **M**.
 - The subject is too bright or too dark.
 - Active D-Lighting is in effect (□ 113).
 - The photograph is a long time-exposure (□ 52).
 - The flash is used (□ 119).
-



Flicker or banding appears during live view or movie recording: Choose an option for **Flicker reduction** that matches the frequency of the local AC power supply (□ 264).

Bright bands appear during live view or movie recording: A flashing sign, flash, or other light source with brief duration was used during live view or movie recording.

Menu item can not be selected: Some options are not available in all modes.

Shooting (P, S, A, M)

Shutter-release disabled:

- Non-CPU lens is attached: rotate camera mode dial to **A** or **M** (□ 47, 298).
 - Mode dial rotated to **S** after shutter speed of Bulb (**b** or **1/b**) or Time (-) selected in mode **M**: choose new shutter speed (□ 49).
-

Full range of shutter speeds not available: Flash in use. Flash sync speed can be selected using Custom Setting e1 (**Flash sync speed**); when using compatible flash units, choose **1/320 s (Auto FP)** or **1/250 s (Auto FP)** for full range of shutter speeds (□ 244).

Colors are unnatural:

- Adjust white balance to match light source (□ 89).
 - Adjust **Set Picture Control** settings (□ 105).
-

Can not measure white balance: Subject is too dark or too bright (□ 97).

Image can not be selected as source for preset white balance: Image was not created with D7100 (□ 100).

White balance bracketing unavailable:

- NEF (RAW) or NEF+JPEG image quality option selected for image quality (□ 66).
 - Multiple exposure mode is in effect (□ 144).
-

Effects of Picture Control differ from image to image: **A** (auto) is selected for sharpening, contrast, or saturation. For consistent results over a series of photos, choose another setting (□ 108).

Metering can not be changed: Autoexposure lock or movie live view is in effect (□ 84, 161).

Exposure compensation can not be used: Choose mode **P, S, or A** (□ 48, 49, 50).

Noise (reddish areas or other artifacts) appears in long time-exposures: Enable long exposure noise reduction (□ 228).

Playback

NEF (RAW) image is not played back: Photo was taken at image quality of NEF + JPEG (□ 66).

Can not view pictures recorded with other cameras: Pictures recorded with other makes of camera may not be displayed correctly.

Message is displayed stating that no images are available for playback: Select **All** for **Playback folder** (□ 217).



“Tall” (portrait) orientation photos are displayed in “wide” (landscape) orientation:

- Select **On** for **Rotate tall** (☞ 222).
- Photo was taken with **Off** selected for **Auto image rotation** (☞ 265).
- Camera was pointed up or down when photo was taken (☞ 265).
- Photo is displayed in image review (☞ 222).

Can not delete picture:

- Picture is protected: remove protection (☞ 196).
- Memory card is locked (☞ 31).

Can not retouch picture: Photo can not be further edited with this camera (☞ 274).

Can not change print order:

- Memory card is full: delete pictures (☞ 35, 197).
- Memory card is locked (☞ 31).

Can not select photo for printing: Photo is in NEF (RAW) format. Create JPEG copy using **NEF (RAW) processing** or transfer to computer and print using ViewNX 2 (supplied) or Capture NX 2 (available separately).

Picture is not displayed on TV:

- Choose correct output resolution (☞ 216).
- HDMI (☞ 215) cable is not correctly connected.

Camera does not respond to remote control for HDMI-CEC television:

- Select **On** for **HDMI > Device control** in the setup menu (☞ 216).
- Adjust HDMI-CEC settings for the television as described in documentation provided with the device.

Can not transfer photos to computer: OS not compatible with camera or transfer software. Use card reader to copy photos to computer (☞ 202).

Photos are not displayed in Capture NX 2: Update to latest version (☞ 309).

Image Dust Off option in Capture NX 2 does not have desired effect: Image sensor cleaning changes the position of dust on the image sensor. Dust off reference data recorded before image sensor cleaning is performed can not be used with photographs taken after image sensor cleaning is performed. Dust off reference data recorded after image sensor cleaning is performed can not be used with photographs taken before image sensor cleaning is performed (☞ 264).

Computer displays NEF (RAW) images differently from camera: Third-party software does not display effects of Picture Controls or Active D-Lighting. Use ViewNX 2 (supplied) or optional Nikon software such as Capture NX 2 (available separately).

Miscellaneous









Date of recording is not correct: Set camera clock (☞ 28, 265).

Menu item can not be selected: Some options are not available at certain combinations of settings or when no memory card is inserted. Note that **Battery info** option is not available when camera is powered by an optional EP-5B power connector and EH-5b AC adapter (☞ 266).



Error Messages

This section lists the indicators and error messages that appear in the viewfinder, control panel, and monitor.

Indicator		Problem	Solution	📖
Control panel	Viewfinder			
 (flashes)		Lens aperture ring is not set to minimum aperture.	Set ring to minimum aperture (highest f-number).	27
		Low battery.	Ready a fully-charged spare battery.	22
 (flashes)	 (flashes)	<ul style="list-style-type: none"> Battery exhausted. Battery can not be used. An extremely exhausted rechargeable Li-ion battery or a third-party battery is inserted either in the camera or in the optional MB-D15 battery pack. 	<ul style="list-style-type: none"> Recharge or replace battery. Contact Nikon-authorized service representative. Replace the battery, or recharge the battery if the rechargeable Li-ion battery is exhausted. 	xxvi, 22, 24
		No lens attached, or non-CPU lens attached without specifying maximum aperture. Aperture shown in stops from maximum aperture.	Aperture value will be displayed if maximum aperture is specified.	149
 (flashes)		<ul style="list-style-type: none"> No lens attached. Non-CPU lens attached. 	<ul style="list-style-type: none"> Attach a lens. If a CPU lens is attached, remove and reattach the lens. Select mode A or M. 	26, 295 47, 298
—	 (flashes)	Camera unable to focus using autofocus.	Change composition or focus manually.	72, 78



Indicator		Problem	Solution	📖
Control panel	View-finder			
(Exposure indicators and shutter speed or aperture display flash)		Subject too bright; photo will be overexposed.	<ul style="list-style-type: none"> • Use a lower ISO sensitivity • In shooting mode: <ul style="list-style-type: none"> P Use optional ND filter S Increase shutter speed A Choose a smaller aperture (higher f-number) ☑ Choose another shooting mode 	79 308 49 50 178
		Subject too dark; photo will be underexposed.	<ul style="list-style-type: none"> • Use a higher ISO sensitivity • In shooting mode: <ul style="list-style-type: none"> P Use flash S Lower shutter speed A Choose a larger aperture (lower f-number) 	79 119 49 50
b u l b (flashes)		Bulb (b u l b) selected in mode S .	Change shutter speed or select mode M .	49, 51
- - (flashes)		Time (- -) selected in mode S .	Change shutter speed or select mode M .	49, 51
b u s y (flashes)	b s y (flashes)	Images are being processed.	Wait until processing is complete.	—
—	 (flashes)	If indicator flashes for 3s after flash fires, photo may be underexposed.	Check photo in monitor; if underexposed, adjust settings and try again.	185
F u l l (flashes)	F u l (flashes)	Memory insufficient to record further photos at current settings, or camera has run out of file or folder numbers.	<ul style="list-style-type: none"> • Reduce quality or size. • Delete photographs. • Insert new memory card. 	66, 68 197 30
E r r (flashes)		Camera malfunction.	Release shutter. If error persists or appears frequently, consult Nikon-authorized service representative.	—



Indicator		Problem	Solution	📖
Monitor	Control panel			
No memory card.	{ - E - }	Camera cannot detect memory card.	Turn camera off and confirm that card is correctly inserted.	30
This memory card cannot be used. Card may be damaged. Insert another card.	E R r d, E r r (flashes)	<ul style="list-style-type: none"> • Error accessing memory card. • Unable to create new folder. 	<ul style="list-style-type: none"> • Use Nikon-approved card. • Check that contacts are clean. If card is damaged, contact retailer or Nikon-authorized service representative. • Delete files or insert new memory card after copying important images to computer or other device. 	347 — 30, 197
	E R r d, E r r (flashes)	Camera can not control Eye-Fi card.	<ul style="list-style-type: none"> • Check that Eye-Fi card firmware is up to date. • Copy files on Eye-Fi card to a computer or other device and format card, or insert new card. 	272 30, 32, 203
Memory card is locked. Slide lock to “write” position.	E R r d, - - - (flashes)	Memory card is locked (write protected).	Slide card write-protect switch to “write” position.	31
Not available if Eye-Fi card is locked.	E R r d, E r r (flashes)	Eye-Fi card is locked (write protected).		
This card is not formatted. Format the card.	[F o r] (flashes)	Memory card has not been formatted for use in camera.	Format memory card or insert new memory card.	30, 32
Clock has been reset	—	Camera clock is not set.	Set camera clock.	28, 265
Failed to update flash unit firmware. Flash cannot be used. Contact a Nikon-authorized service representative.	—	Firmware for flash unit mounted on camera was not updated correctly.	Contact a Nikon-authorized service representative.	—
Unable to start live view. Please wait.	—	The internal temperature of the camera is high.	Wait for the internal circuits to cool before resuming live view or movie recording.	154, 168



Indicator		Problem	Solution	📖
Monitor	Control panel			
Folder contains no images.	—	No images on memory card or in folder(s) selected for playback.	Select folder containing images from Playback folder menu or insert memory card containing images.	30, 217
All images are hidden.	—	All photos in current folder are hidden.	No images can be played back until another folder has been selected or Hide image used to allow at least one image to be displayed.	218
Cannot display this file.	—	File has been created or modified using a computer or different make of camera, or file is corrupt.	File can not be played back on camera.	—
Cannot select this file.	—	Selected image can not be retouched.	Images created with other devices can not be retouched.	274
This movie cannot be edited.	—	The selected movie can not be edited.	<ul style="list-style-type: none"> • Movies created with other devices can not be edited. • Movies must be at least two seconds long. 	— 175
Check printer.	—	Printer error.	Check printer. To resume, select Continue (if available).	208 *
Check paper.	—	Paper in printer is not of selected size.	Insert paper of correct size and select Continue .	208 *
Paper jam.	—	Paper is jammed in printer.	Clear jam and select Continue .	208 *
Out of paper.	—	Printer is out of paper.	Insert paper of selected size and select Continue .	208 *
Check ink supply.	—	Ink error.	Check ink. To resume, select Continue .	208 *
Out of ink.	—	Printer is out of ink.	Replace ink and select Continue .	208 *

* See printer manual for more information.





Specifications

■ Nikon D7100 Digital Camera

Type	
Type	Single-lens reflex digital camera
Lens mount	Nikon F mount (with AF coupling and AF contacts)
Effective angle of view	Nikon DX format; focal length in 35 mm [135] format equivalent to approx. 1.5× that of lenses with FX format angle of view
Effective pixels	
Effective pixels	24.1 million
Image sensor	
Image sensor	23.5 × 15.6 mm CMOS sensor
Total pixels	24.71 million
Dust-reduction System	Image sensor cleaning, Image Dust Off reference data (optional Capture NX 2 software required)
Storage	
Image size (pixels)	<ul style="list-style-type: none"> • DX (24×16) image area 6000 × 4000 (L) 4496 × 3000 (M) 2992 × 2000 (S) • 1.3× (18×12) image area 4800 × 3200 (L) 3600 × 2400 (M) 2400 × 1600 (S) • Photographs with image area of DX (24×16) taken in movie live view 6000 × 3368 (L) 4496 × 2528 (M) 2992 × 1680 (S) • Photographs with image area of 1.3× (18×12) taken in movie live view 4800 × 2696 (L) 3600 × 2024 (M) 2400 × 1344 (S)
File format	<ul style="list-style-type: none"> • NEF (RAW): 12 or 14 bit, lossless compressed or compressed • JPEG: JPEG-Baseline compliant with fine (approx. 1 : 4), normal (approx. 1 : 8), or basic (approx. 1 : 16) compression (Size priority); Optimal quality compression available • NEF (RAW) + JPEG: Single photograph recorded in both NEF (RAW) and JPEG formats
Picture Control System	Standard, Neutral, Vivid, Monochrome, Portrait, Landscape; selected Picture Control can be modified; storage for custom Picture Controls
Media	SD (Secure Digital) and UHS-I compliant SDHC and SDXC memory cards
Double slot	Slot 2 can be used for overflow or backup storage or for separate storage of copies created using NEF+JPEG; pictures can be copied between cards.
File system	DCF (Design Rule for Camera File System) 2.0, DPOF (Digital Print Order Format), Exif (Exchangeable Image File Format for Digital Still Cameras) 2.3, PictBridge



Exposure	
Metering method	<ul style="list-style-type: none"> • Matrix: 3D color matrix metering II (type G and D lenses); color matrix metering II (other CPU lenses); color matrix metering available with non-CPU lenses if user provides lens data • Center-weighted: Weight of 75% given to 8 mm circle in center of frame. Diameter of circle can be changed to 6, 10, or 13 mm, or weighting can be based on average of entire frame (non-CPU lenses use 8-mm circle) • Spot: Meters 3.5 mm circle (about 2.5% of frame) centered on selected focus point (on center focus point when non-CPU lens is used)
Range (ISO 100, f/1.4 lens, 20 °C/68 °F)	<ul style="list-style-type: none"> • Matrix or center-weighted metering: 0–20 EV • Spot metering: 2–20 EV
Exposure meter coupling	Combined CPU and AI
Mode	Auto modes (📷 auto; ⏻ auto, flash off); programmed auto with flexible program (P); shutter-priority auto (S); aperture-priority auto (A); manual (M); scene modes (👤 portrait; 🏞 landscape; 🧒 child; 🏃 sports; 📷 close up; 🌃 night portrait; 🌃 night landscape; 🎉 party/indoor; 🏖 beach/snow; 🌅 sunset; 🌄 dusk/dawn; 🐾 pet portrait; 🕯 candlelight; 🌸 blossom; 🍁 autumn colors; 🍽 food); special effects modes (🌃 night vision; 🎨 color sketch; 🏠 miniature effect; 🎯 selective color; 🖋 silhouette; 🗝 high key; 🗝 low key); U1 (user settings 1); U2 (user settings 2)
Exposure compensation	Can be adjusted by –5 – +5 EV in increments of $1/3$ or $1/2$ EV in P, S, A, and M modes
Exposure bracketing	2–5 frames in steps of $1/3$, $1/2$, $2/3$, 1, 2, or 3 EV
Flash bracketing	2–5 frames in steps of $1/3$, $1/2$, $2/3$, 1, 2, or 3 EV
White balance bracketing	2–5 frames in steps of 1, 2, or 3
ADL bracketing	2 frames using selected value for one frame or 3 frames using preset values for all frames
Exposure lock	Luminosity locked at detected value with $\overline{AE-L}$ AE-L/AF-L button
ISO sensitivity (Recommended Exposure Index)	ISO 100 – 6400 in steps of $1/3$ or $1/2$ EV. Can also be set to approx. 0.3, 0.5, 0.7, 1, or 2 EV (ISO 25600 equivalent) above ISO 6400; auto ISO sensitivity control available
Active D-Lighting	Auto, Extra high, High, Normal, Low, Off
Focus	
Autofocus	Nikon Advanced Multi-CAM 3500DX autofocus sensor module with TTL phase detection, fine-tuning, 51 focus points (including 15 cross-type sensors; the center 1 focus point is available at apertures slower than f/5.6 and faster than f/8 or at f/8), and AF-assist illuminator (range approx. 0.5–3 m/1 ft 8 in.–9 ft 10 in.)
Detection range	–2 – +19 EV (ISO 100, 20 °C/68 °F)
Lens servo	<ul style="list-style-type: none"> • Autofocus (AF): Single-servo AF (AF-S); continuous-servo AF (AF-C); auto AF-S/AF-C selection (AF-A); predictive focus tracking activated automatically according to subject status • Manual focus (M): Electronic rangefinder can be used
Focus point	Can be selected from 51 or 11 focus points
AF-area mode	Single-point AF; 9-, 21-, or 51-point dynamic-area AF, 3D-tracking, auto-area AF

Focus	
Focus lock	Focus can be locked by pressing shutter-release button halfway (single-servo AF) or by pressing  AE-L/AF-L button
Flash	
Built-in flash	 : Auto flash with auto pop-up P, S, A, M, 11: Manual pop-up with button release
Guide Number	Approx. 12/39, 12/39 with manual flash (m/ft, ISO 100, 20 °C/68 °F)
Flash control	TTL: i-TTL flash control using 2016-pixel RGB sensor is available with built-in flash and SB-910, SB-900, SB-800, SB-700, SB-600, or SB-400; i-TTL balanced fill-flash for digital SLR is used with matrix and center-weighted metering, standard i-TTL flash for digital SLR with spot metering
Flash mode	Auto, auto with red-eye reduction, auto slow sync, auto slow sync with red-eye reduction, fill-flash, red-eye reduction, slow sync, slow sync with red-eye reduction, rear-curtain with slow sync, rear-curtain sync, off; Auto FP High-Speed Sync supported
Flash compensation	-3 – +1 EV in increments of $\frac{1}{3}$ or $\frac{1}{2}$ EV
Flash-ready indicator	Lights when built-in flash or optional flash unit is fully charged; flashes after flash is fired at full output
Accessory shoe	ISO 518 hot-shoe with sync and data contacts and safety lock
Nikon Creative Lighting System (CLS)	<ul style="list-style-type: none"> Advanced Wireless Lighting supported with: <ul style="list-style-type: none"> SB-910, SB-900, SB-800, or SB-700 as a master flash and SB-600 or SB-R200 as remotes, or SU-800 as commander Built-in flash can serve as master flash in commander mode Auto FP High-Speed Sync and modeling illumination supported with all CLS-compatible flash units except SB-400; Flash Color Information Communication and FV lock supported with all CLS-compatible flash units
Sync terminal	AS-15 sync terminal adapter (available separately)
White balance	
White balance	Auto (2 types), incandescent, fluorescent (7 types), direct sunlight, flash, cloudy, shade, preset manual (up to 6 values can be stored, spot white balance measurement available during live view), choose color temperature (2500 K–10000 K), all with fine-tuning
Live view	
Modes	Live view photography (still images), movie live view (movies)
Lens servo	<ul style="list-style-type: none"> Autofocus (AF): Single-servo AF (AF-S); full-time-servo AF (AF-F) Manual focus (M)
AF-area mode	Face-priority AF, wide-area AF, normal-area AF, subject-tracking AF
Autofocus	Contrast-detect AF anywhere in frame (camera selects focus point automatically when face-priority AF or subject-tracking AF is selected)
Movie	
Metering	TTL exposure metering using main image sensor
Metering method	Matrix



Movie	
Frame size (pixels) and frame rate	<ul style="list-style-type: none"> • 1920 × 1080; 60i (59.94 fields/s)/ 50i (50 fields/s) * • 1920 × 1080; 30p (progressive), 25p, 24p • 1280 × 720; 60p, 50p <p>Actual frame rates for 60p, 50p, 30p, 25p, and 24p are 59.94, 50, 29.97, 25, and 23.976 fps respectively; options support both ★high and normal image quality</p>
File format	MOV
Video compression	H.264/MPEG-4 Advanced Video Coding
Audio recording format	Linear PCM
Audio recording device	Built-in or external stereo microphone; sensitivity adjustable

* Available only when **1.3x (18×12)** is selected for Image area. Sensor output is about 60 or 50 fps.

Monitor	
Monitor	8-cm/3.2-in., approx. 1229 k-dot (VGA; 640 × 480 × 4 = 1,228,800 dots), TFT monitor with approx. 170° viewing angle, approx. 100% frame coverage, and brightness adjustment

Playback	
Playback	Full-frame and thumbnail (4, 9, or 72 images or calendar) playback with playback zoom, movie playback, photo and/or movie slide shows, histogram display, highlights, photo information, GPS data display, and auto image rotation

Interface	
USB	Hi-Speed USB
HDMI output	HDMI mini connector (Type C)
Accessory terminal	Wireless remote controller: WR-1 and WR-R10 (available separately) Remote cord: MC-DC2 (available separately) GPS unit: GP-1 (available separately)
Audio input	Stereo mini-pin jack (3.5 mm diameter; plug-in power supported)
Audio output	Stereo mini-pin jack (3.5 mm diameter)

Supported languages	
Supported languages	Arabic, Bengali, Chinese (Simplified and Traditional), Czech, Danish, Dutch, English, Finnish, French, German, Greek, Hindi, Hungarian, Indonesian, Italian, Japanese, Korean, Norwegian, Persian, Polish, Portuguese (European and Brazilian), Romanian, Russian, Spanish, Swedish, Tamil, Thai, Turkish, Ukrainian, Vietnamese

Power source	
Battery	One rechargeable Li-ion EN-EL15 battery
Battery pack	Optional MB-D15 multi-power battery pack with one rechargeable Nikon EN-EL15 Li-ion battery or six AA alkaline, Ni-MH, or lithium batteries
AC adapter	EH-5b AC adapter; requires EP-5B power connector (available separately)
Tripod socket	
Tripod socket	1/4 in. (ISO 1222)



Dimensions/weight	
Dimensions (W × H × D)	Approx. 135.5 × 106.5 × 76 mm (5.3 × 4.2 × 3.0 in.)
Weight	Approx. 765 g (1 lb 11.0 oz) with battery and memory card but without body cap; approx. 675 g (1 lb 7.8 oz; camera body only)
Operating environment	
Temperature	0 °C–40 °C (+32 °F–104 °F)
Humidity	85% or less (no condensation)

- Unless otherwise stated, all figures are for a camera with a fully-charged battery operating at the temperature specified by the Camera and Imaging Products Association (CIPA): 23 ±3 °C (73.4 ±5.4 °F).
- Nikon reserves the right to change the specifications of the hardware and software described in this manual at any time and without prior notice. Nikon will not be held liable for damages that may result from any mistakes that this manual may contain.

■ ■ **MH-25 battery charger**

Rated input (in North America)	AC 120 V, 60 Hz, 0.2 A
Rated input (in other regions)	AC 100–240 V, 50/60 Hz, 0.23–0.12 A
Rated output	DC 8.4 V/1.2 A
Supported batteries	Nikon Rechargeable Li-ion Battery EN-EL15
Charging time	Approx. 2 hours and 35 minutes at an ambient temperature of 25 °C (77 °F) when no charge remains
Operating temperature	0 °C–40 °C (+32 °F–104 °F)
Dimensions (W × H × D)	Approx. 91.5 × 33.5 × 71 mm (3.6 × 1.3 × 2.8 in.), excluding projections
Length of power cable	Approx. 1.8 m/6 ft (U.S.A. and Canada) or 1.5 m/4.9 ft (other countries)
Weight	Approx. 110 g (3.9 oz), excluding power cable and AC wall adapter

■ ■ **EN-EL15 rechargeable Li-ion battery**

Type	Rechargeable lithium-ion battery
Rated capacity	7.0 V/1900 mAh
Operating temperature	0 °C–40 °C (+32 °F–104 °F)
Dimensions (W × H × D)	Approx. 40 × 56 × 20.5 mm (1.6 × 2.2 × 0.8 in.)
Weight	Approx. 88 g (3.1 oz), excluding terminal cover



■ AF-S DX NIKKOR 18–105mm f/3.5–5.6G ED VR lens

Type	Type G AF-S DX NIKKOR zoom lens with built-in CPU and F mount for use exclusively with Nikon DX-format digital SLR cameras
Focal length	18–105 mm
Maximum aperture	f/3.5–5.6
Lens construction	15 elements in 11 groups (including 1 aspherical element and 1 ED glass element)
Angle of view	76°–15° 20′
Focal length scale	Graduated in millimeters (18, 24, 35, 50, 70, 105)
Distance information	Output to camera
Zoom	Manual zoom using independent zoom ring
Focusing	Nikon Internal Focusing (IF) system with autofocus controlled by Silent Wave Motor; manual focus supported when A-M switch is set to A or M . Focus can be adjusted by rotating lens focus ring while focus is locked in single-servo autofocus. Do not use focus ring while camera is focusing.
Vibration reduction	Lens-shift method using voice coil motors (VCMs)
Minimum focus distance	0.45 m (1.5 ft) from focal plane (□ 78) at all zoom positions
Diaphragm blades	7 (rounded diaphragm opening)
Diaphragm	Fully automatic
Aperture range	• 18 mm focal length: f/3.5–22 • 105 mm focal length: f/5.6–38
Metering	Full aperture
Filter-attachment size	67 mm (P=0.75 mm)
Dimensions	Approx. 76 mm diameter × 89 mm/3.0 × 3.5 in. (distance from camera lens-mount flange)
Weight	Approx. 420 g (14.8 oz)

Nikon reserves the right to change the specifications of the hardware and software described in this manual at any time and without prior notice. Nikon will not be held liable for damages that may result from any mistakes that this manual may contain.



The AF-S DX NIKKOR 18–105 mm f/3.5–5.6G ED VR

The AF-S DX NIKKOR 18–105 mm f/3.5–5.6G ED VR is for use exclusively with Nikon DX format digital cameras. Superior optical performance and image rendering are ensured by the use of aspherical lens elements and elements made using extra-low dispersion (ED) glass to correct chromatic aberration. A rounded aperture produces soft, esthetically-pleasing blurring of point light sources in out-of-focus areas of the image (*bokeh*).

■ ■ **Vibration Reduction (VR)**

AF-S DX NIKKOR 18–105 mm f/3.5–5.6G ED VR lenses support vibration reduction (VR), which reduces blur caused by camera shake even when the camera is panned, allowing shutter speeds to be slowed by approximately 3 EV (Nikon measurements; effects vary with the user and shooting conditions).

To use vibration reduction, slide the vibration reduction ON/OFF switch to **ON**. Vibration reduction is activated when the shutter-release button is pressed halfway, reducing the effects of camera shake on the image in the viewfinder and simplifying the process of framing the subject and focusing in both autofocus and manual focus modes. When the camera is panned, vibration reduction applies only to motion that is not part of the pan (if the camera is panned horizontally, for example, vibration reduction will be applied only to vertical shake), making it much easier to pan the camera smoothly in a wide arc.

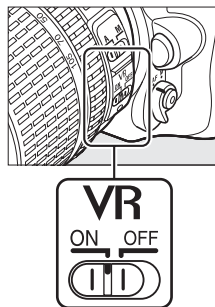

Vibration reduction can be turned off by sliding the vibration reduction ON/OFF switch to **OFF**. Turn vibration reduction off when the camera is securely mounted on a tripod, but leave it on if the tripod head is not secured or when using a monopod.

Vibration Reduction

Do not turn the camera off or remove the lens while vibration reduction is in effect. If power to the lens is cut while vibration reduction is on, the lens may rattle when shaken. This is not a malfunction, and can be corrected by reattaching the lens and turning the camera on. Vibration reduction is disabled while the built-in flash is charging. When vibration reduction is active, the image in the viewfinder may be blurred after the shutter is released. This does not indicate a malfunction.



Using the Built-in Flash

When using the built-in flash, be sure the subject is at a range of at least 0.6 m (2 ft) and remove lens hoods to prevent vignetting (shadows created where the end of the lens obscures the built-in flash).

Camera	Zoom position	Minimum distance without vignetting
D5000, D3100, D3000	18 mm	2.5 m/8 ft 2 in.
	24 mm	1.0 m/3 ft 3 in.
D5200, D5100, D3200	18 mm	3.0 m/9 ft 10 in.
	24 mm	1.0 m/3 ft 3 in.
D700, D7100, D7000, D300 series, D200, D100, D80	All	No vignetting at any focus distance
D90, D70 series	18 mm	1.5 m/4 ft 11 in.
	24–105 mm	No vignetting at any focus distance
D50	18 mm	1.0 m/3 ft 3 in.
	24–105 mm	No vignetting at any focus distance
D60, D40 series	18 mm	2.5 m/8 ft 2 in.
	24 mm	1.0 m/3 ft 3 in.
	35–105 mm	No vignetting at any focus distance

Because the built-in flash units for the D100 and D70 can only cover the angle of view of a lens with a focal length of 20 mm or more; vignetting will occur at a focal length of 18 mm.

Lens Care

- Keep the CPU contacts clean.
- Use a blower to remove dust and lint from the lens surfaces. To remove smudges and fingerprints, apply a small amount of ethanol or lens cleaner to a soft, clean cotton cloth or lens-cleaning tissue and clean from the center outwards using a circular motion, taking care not to leave smears or touch the glass with your fingers.
- Never use organic solvents such as paint thinner or benzene to clean the lens.
- The lens hood or NC filters can be used to protect the front lens element.
- Attach the front and rear caps before placing the lens in its flexible pouch.
- When a lens hood is attached, do not pick up or hold the lens or camera using only the hood.
- If the lens will not be used for an extended period, store it in a cool, dry location to prevent mold and rust. Do not store in direct sunlight or with naphtha or camphor moth balls.
- Keep the lens dry. Rusting of the internal mechanism can cause irreparable damage.
- Leaving the lens in extremely hot locations could damage or warp parts made from reinforced plastic.



Supplied Accessories

- 67 mm Snap-on Front Lens Cap LC-67
- Rear Lens Cap
- Flexible Lens Pouch CL-1018
- Bayonet Hood HB-32 (attaches as shown at right)

Optional Accessories

- 67 mm screw-on filters
- Rear Lens Cap LF-1 or Rear Lens Cap LF-4

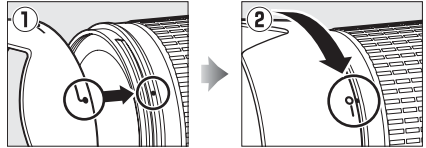
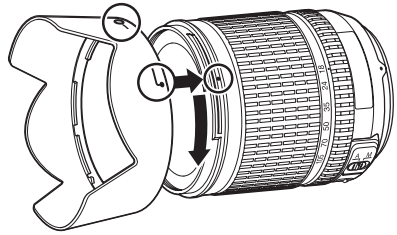

A Note on Wide-Angle Lenses

Autofocus may not provide the desired results with wide- and super-wide-angle lenses in the following situations:

1 The subject does not fill the focus point.

If the subject does not fill the focus point, the camera may focus on the background and the subject may be out of focus.



Example: A far-off portrait subject at some distance from the background

2 The subject contains many fine details.

The camera may have difficulty focusing on subjects that contain many fine details or that are lacking in contrast.

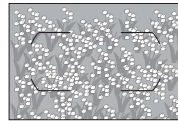

Example: A field of flowers

In these cases, use manual focus, or use focus lock to focus on another subject at the same distance and then recompose the photograph. For more information, see “Getting Good Results with Autofocus” (□ 72).



■ Supported Standards

- **DCF Version 2.0:** The Design Rule for Camera File Systems (DCF) is a standard widely used in the digital camera industry to ensure compatibility among different makes of camera.
- **DPOF:** Digital Print Order Format (DPOF) is an industry-wide standard that allows pictures to be printed from print orders stored on the memory card.
- **Exif version 2.3:** The camera supports Exif (Exchangeable Image File Format for Digital Still Cameras) version 2.3, a standard in which information stored with photographs is used for optimal color reproduction when the images are output on Exif-compliant printers.
- **PictBridge:** A standard developed through cooperation with the digital camera and printer industries, allowing photographs to be output directly to a printer without first transferring them to a computer.
- **HDMI:** High-Definition Multimedia Interface is a standard for multimedia interfaces used in consumer electronics and AV devices capable of transmitting audiovisual data and control signals to HDMI-compliant devices via a single cable connection.

Trademark Information

Macintosh, Mac OS, and QuickTime are registered trademarks of Apple Inc. in the United States and/or other countries. Microsoft, Windows, and Windows Vista are either registered trademarks, or trademarks of Microsoft Corporation in the United States and/or other countries. PictBridge is a trademark. The SD, SDHC, and SDXC logos are trademarks of the SD-3C, LLC. HDMI, the HDMI logo and High-Definition Multimedia Interface are trademarks or registered trademarks of HDMI Licensing LLC.

HDMI

All other trade names mentioned in this manual or the other documentation provided with your Nikon product are trademarks or registered trademarks of their respective holders.

FreeType License (FreeType2)

Portions of this software are copyright © 2013 The FreeType Project ("www.freetype.org"). All rights reserved.

MIT License (HarfBuzz)

Portions of this software are copyright © 2013 The HarfBuzz Project ("<http://www.freedesktop.org/wiki/Software/HarfBuzz>"). All rights reserved.



Approved Memory Cards

The following SD memory cards have been tested and approved for use in the camera. Cards with class 6 or faster write speeds are recommended for movie recording. Recording may end unexpectedly when cards with slower write speeds are used.

	SD cards	SDHC cards ²	SDXC cards ³
SanDisk	2 GB ¹	4 GB, 8 GB, 16 GB, 32 GB	64 GB
Toshiba			
Panasonic		4 GB, 6 GB, 8 GB, 12 GB, 16 GB, 24 GB, 32 GB	48 GB, 64 GB
Lexar Media		4 GB, 8 GB, 16 GB	—
Platinum II			
Professional	4 GB, 8 GB, 16 GB, 32 GB		
Full-HD Video	—	4 GB, 8 GB, 16 GB	

1 Check that any card readers or other devices with which the card will be used support 2 GB cards.

2 Check that any card readers or other devices with which the card will be used are SDHC-compliant. The camera supports UHS-I.

3 Check that any card readers or other devices with which the card will be used are SDXC-compliant. The camera supports UHS-I.



Other cards have not been tested. For more details on the above cards, please contact the manufacturer.



Memory Card Capacity

The following table shows the approximate number of pictures that can be stored on an 8 GB SanDisk Extreme Pro SDHC UHS-I card at different image quality (☐ 66), image size (☐ 68), and image area settings (☐ 63).

■ ■ DX (24×16) Image Area

Image quality	Image size	File size ¹	No. of images ¹	Buffer capacity ²
NEF (RAW), Lossless compressed, 12-bit	—	22.7 MB	191	7
NEF (RAW), Lossless compressed, 14-bit	—	28.5 MB	148	6
NEF (RAW), Compressed, 12-bit	—	20.2 MB	260	9
NEF (RAW), Compressed, 14-bit	—	24.9 MB	217	8
JPEG fine ³	Large	12.0 MB	507	33
	Medium	7.4 MB	853	100
	Small	3.8 MB	1600	100
JPEG normal ³	Large	6.2 MB	1000	100
	Medium	3.7 MB	1600	100
	Small	1.9 MB	3200	100
JPEG basic ³	Large	2.9 MB	1900	100
	Medium	1.9 MB	3200	100
	Small	1.0 MB	6000	100

■ ■ 1.3× (18×12) Image Area

Image quality	Image size	File size ¹	No. of images ¹	Buffer capacity ²
NEF (RAW), Lossless compressed, 12-bit	—	15.1 MB	295	12
NEF (RAW), Lossless compressed, 14-bit	—	18.8 MB	229	8
NEF (RAW), Compressed, 12-bit	—	13.4 MB	399	14
NEF (RAW), Compressed, 14-bit	—	16.3 MB	334	11
JPEG fine ³	Large	8.2 MB	764	73
	Medium	5.0 MB	1200	100
	Small	2.7 MB	2200	100
JPEG normal ³	Large	4.1 MB	1500	100
	Medium	2.5 MB	2400	100
	Small	1.4 MB	4400	100
JPEG basic ³	Large	2.0 MB	2900	100
	Medium	1.3 MB	4600	100
	Small	0.7 MB	8000	100

1 All figures are approximate. File size varies with scene recorded.

2 Maximum number of exposures that can be stored in memory buffer at ISO 100. Drops if **Optimal quality** is selected for **JPEG compression** (☐ 67), ISO sensitivity is set to Hi 0.3 or higher, or long exposure noise reduction or auto distortion control is on.

3 Figures assume **JPEG compression** is set to **Size priority**. Selecting **Optimal quality** increases the file size of JPEG images; number of images and buffer capacity drop accordingly.



 **d6—Max. Continuous Release** (📖 240)

The maximum number of photographs that can be taken in a single burst can be set to any amount between 1 and 100.



Battery Life

The movie footage or number of shots that can be recorded with fully-charged batteries varies with the condition of the battery, temperature, the interval between shots, and the length of time menus are displayed. In the case of AA batteries, capacity also varies with make and storage conditions; some batteries can not be used. Sample figures for the camera and optional MB-D15 multi-power battery pack are given below.

- **Photographs, single-frame release mode (CIPA standard ¹)**

One EN-EL15 battery (camera): Approximately 950 shots

One EN-EL15 battery (MB-D15): Approximately 950 shots

Six AA alkaline batteries (MB-D15): Approximately 450 shots

- **Photographs, continuous release mode (Nikon standard ²)**

One EN-EL15 battery (camera): Approximately 3550 shots

One EN-EL15 battery (MB-D15): Approximately 3550 shots

Six AA alkaline batteries (MB-D15): Approximately 1200 shots

- **Movies ³**

One EN-EL15 battery (camera): Approximately 100 minutes of HD footage

One EN-EL15 battery (MB-D15): Approximately 100 minutes of HD footage

Six AA alkaline batteries (MB-D15): Approximately 30 minutes of HD footage

1 Measured at 23 °C/73.4 °F (±3 °C/5.4 °F) with an AF-S DX NIKKOR 18–105mm f/3.5–5.6G ED VR lens under the following test conditions: lens cycled from infinity to minimum range and one photograph taken at default settings once every 30 s; flash fired once every other shot. Live view not used.

2 Measured at 20 °C/68 °F with an AF-S DX NIKKOR 18–105mm f/3.5–5.6G ED VR lens under the following test conditions: image quality set to JPEG basic, image size set to **M** (medium), shutter speed $1/250$ s, shutter-release button pressed halfway for three seconds and focus cycled from infinity to minimum range three times; six shots are then taken in succession and monitor turned on for five seconds and then turned off; cycle repeated once standby timer expires.

3 Measured at 23 °C/73.4 °F (±3 °C/5.4 °F) with the camera at default settings and an AF-S DX NIKKOR 18–105 mm f/3.5-5.6G ED VR lens under conditions specified by the Camera and Imaging Products Association (CIPA). Individual movies can be up to 29 minutes and 59 seconds (1920 × 1080/30p) in length or 4 GB in size; recording may end before these limits are reached if the camera temperature rises.



The following can reduce battery life:

- Using the monitor
- Keeping the shutter-release button pressed halfway
- Repeated autofocus operations
- Taking NEF (RAW) photographs
- Slow shutter speeds
- Using a GPS unit
- Using an Eye-Fi card
- Using a wireless remote controller, WU-1a wireless mobile adapter, or UT-1 communication unit
- Using VR (vibration reduction) mode with VR lenses





































To ensure that you get the most from rechargeable Nikon EN-EL15 batteries:









- Keep the battery contacts clean. Soiled contacts can reduce battery performance.
- Use batteries immediately after charging. Batteries will lose their charge if left unused.



Index

Symbols

 (Auto mode)..... 36
 (Auto (flash off) mode) 36
SCENE (Scene)..... 41
 (Portrait) 41
 (Landscape) 41
 (Child)..... 42
 (Sports)..... 42
 (Close up) 42
 (Night portrait) 42
 (Night landscape)..... 43
 (Party/indoor) 43
 (Beach/snow) 43
 (Sunset) 43
 (Dusk/dawn) 44
 (Pet portrait) 44
 (Candlelight) 44
 (Blossom)..... 44
 (Autumn colors) 45
 (Food) 45
EFFECTS (Special effects) 177
 (Night Vision) 178
 (Color Sketch)..... 178, 180
 (Miniature Effect)..... 178, 181
 (Selective Color) 179, 182
 (Silhouette) 179
 (High Key) 179
 (Low Key) 179
P (Programmed auto)..... 48
S (Shutter-priority auto) 49
A (Aperture-priority auto)..... 50
M (Manual) 51
U1/U2 55
S (Single frame) 7, 57
CL (Continuous low speed)
..... 7, 57, 239
CH (Continuous high speed).... 7, 57
Q (Quiet shutter-release)..... 7, 57
 (Self-timer)..... 7, 57, 59
MUP (Mirror up)..... 7, 57, 61
 (Face-priority AF) 156
 (Wide-area AF) 156
 (Normal-area AF) 156
 (Subject-tracking AF) 156
 (Matrix)..... 83
 (Center-weighted) 83, 236
 (Spot)..... 83
AUTO (Auto flash)..... 120, 121
 (Red-eye reduction).... 120, 121
SLOW (Slow sync) 120, 121
REAR (Rear-curtain sync) ... 120, 121
 (Exposure compensation) 86
 (Flash compensation) 124

 (Flexible program) 48
 (Info) button 10, 12, 159, 166
 i button 18
 (Live view) button. 98, 153, 161
 switch..... 3
WB (White balance) 89
PRE (Preset manual) 89, 95
BKT (Bracketing) 133, 186
 (Help) 19
 (Focus indicator)..... 37, 76, 78
 (Memory buffer) 37, 58
 (Flash-ready indicator) 38

Numerics

1.3× (18×12) 58, 63, 68, 167
12-bit 67
14-bit 67
2016-pixel RGB sensor..... 122, 337
3D-tracking 73, 74

A

AC adapter 308, 311
Accessories 308
Accessory shoe 303
Accessory terminal 310
Active D-Lighting 113, 139
Add items (My Menu) 291
ADL bracketing 139, 251
Adobe RGB 227
AE & flash (Auto bracketing set)
..... 133, 251
AE lock 84
AE only (Auto bracketing set)
..... 133, 251
AE-L/AF-L button..... 76, 84, 256, 260
AF 71–76, 155–156
AF area brackets 9, 33
AF fine-tune 270
AF point illumination 232
AF-A 71
AF-area mode 73, 156
AF-assist 233, 301, 307
AF-C 71, 231
AF-F 155
AF-mode button... 72, 74, 155, 156
AF-S 71, 155, 231
After delete 222
A-M mode switch 26, 27, 78
Angle of view 302
Aperture 50–51
Aperture-priority auto 50
Aspect ratio 277
Assign AE-L/AF-L button . 256, 260
Assign Fn button 253, 259

Assign MB-D15  button 259
Assign preview button 255, 260
Assign shutter button 260
Attaching the lens 26
Auto (White balance) 89
Auto bracketing 133, 251
Auto bracketing set 251
Auto distortion control 227
Auto flash 121
Auto FP high-speed sync. 244, 245
Auto image rotation 265
Auto ISO sensitivity control 81
Auto-area AF 73, 74
Autoexposure lock 84
Autofocus 71–76, 155–156
Autofocus mode 71, 155
Auto-servo AF 71
Available settings 321

B

Backlight 3, 241
Backup (Role played by card in
Slot 2) 69
Battery 22, 24, 35, 266, 341
Battery info 266
Battery life 350
Battery order 243
Battery pack
..... 242, 243, 259, 266, 308
Beep 238
Bit rate 169
Black-and-white (Monochrome)
..... 277
Blue intensifier (Filter effects) .. 278
Body cap 4, 26, 309
Border (PictBridge) 209
Bracketing 133, 251
Bracketing order 251
Built-in AF-assist illuminator ... 233
Built-in flash 38, 119, 299
Bulb 51, 52
Burst 143, 240, 253

C

Calendar playback 194
Camera Control Pro 2 309
Capture NX 2 67, 263, 266, 309
CEC 216
Center-weighted 83, 236
Charging the battery 22–23
Choose color temp. (White
balance) 89, 94
Choose start/end point 173
CL mode shooting speed 239

Clean image sensor 313
 Clock 28, 265
 Clock battery 29
 Cloudy (White balance) 89
 CLS 304
 Color balance 279
 Color outline 286
 Color sketch 286
 Color space 227
 Color temperature 89, 90, 94
 Commander mode 247
 Compatible lenses 295
 Compressed (Type) 67
 Connector for external
 microphone 3
 Continuous high speed 7, 57
 Continuous low speed 7, 57, 239
 Continuous release mode 7, 57
 Continuous-servo AF 71, 231
 Control panel 8
 Copy image(s) 219
 Copyright 190, 267
 CPU contacts 296
 CPU lens 27, 295
 Creative Lighting System 304
 Cross screen (Filter effects) 278
 Custom Settings 229
 Customize command dials 257
 Cyanotype (Monochrome) 277

D

Date and time 28, 265
 Date format 265
 Daylight saving time 265
 DCF 227, 346
 Default settings
 131, 224, 231, 324
 Delayed remote (Remote control
 mode (ML-L3)) 127
 Delete 40, 197
 Delete all images 198
 Delete current image 40, 197
 Delete selected images 198
 Depth-of-field 50
 Depth-of-field preview button
 50, 251, 255, 260
 Destination (Movie settings) 169
 Device control (HDMI) 216
 Digital Print Order Format
 210, 213, 346
 Diopter adjustment control
 33, 308
 Direct sunlight (White balance) 89
 Distortion control 285
 D-Lighting 276
 DPOF 210, 213, 346

DPOF print order 213
 DX (24x16) 58, 63, 68, 167
 Dynamic-area AF 73, 74

E

Easy exposure compensation 235
 Edit movie 173
 Electronic rangefinder 78
 EV steps for exposure cntrl 234
 Exif 227, 346
 Exposure 83–87
 Exposure bracketing 133, 251
 Exposure comp. for flash 250
 Exposure compensation 86
 Exposure delay mode 241
 Exposure indicator 51
 Exposure lock 84
 Exposure meters 38, 237
 Exposure program 327
 External microphone 165, 169
 Eye-Fi upload 272

F

Face-priority AF 156
 File naming 226
 File number sequence 240
 Filter effects 108, 109, 278
 Fine-tune optimal exposure 236
 Fine-tuning white balance 91
 Firmware version 272
 Fisheye 285
 Flash 38, 119, 120, 124, 125, 303
 Flash (White balance) 89
 Flash bracketing 133, 251
 Flash cntrl for built-in flash 246
 Flash compensation 124
 Flash mode 120, 121
 Flash only (Auto bracketing set)
 133, 251
 Flash range 123
 Flash ready indicator 38, 125, 307
 Flash shutter speed 122, 245
 Flash sync speed 244, 245, 337
 Flash warning 241
 Flexible program 48
 Flicker reduction 264
 Fluorescent (White balance) 89
 Fn button 65, 125, 151, 253, 259
 f-number 47, 50, 298
 Focal length 150, 302
 Focal length mark 26
 Focal length scale 26
 Focal plane mark 78
 Focus indicator 37, 76, 78
 Focus lock 76
 Focus mode 71, 155

Focus point
 37, 73, 75, 78, 156, 232, 233
 Focus point wrap-around 232
 Focus tracking 71, 232
 Focus tracking with lock-on 232
 Focusing screen 337
 Focus-mode selector 71, 155
 Format memory card 32, 262
 Frame interval (Slide show) 223
 Frame size/frame rate 169
 Framing guides 159, 166
 Front-curtain sync 121
 Full-frame playback 185
 Full-time-servo AF 155
 FV lock 125

G

GPS 152, 191
 GPS data 191
 GPS unit 152, 310
 Green intensifier (Filter effects)
 278

H

H.264 340
 HDMI 160, 168, 215, 346
 HDMI mini connector (Type C) 3
 HDMI-CEC 216
 HDR mode 115
 HDR strength 116
 Headphones 165
 Help 19
 Hi (Sensitivity) 80
 Hide image 218
 High definition 215, 346
 High Dynamic Range (HDR) 115
 High ISO NR 228
 Highlights 188, 219
 Histogram 188, 189, 219

I

Image area 63, 64, 68, 167
 Image comment 266
 Image Dust Off ref photo 263
 Image overlay 280
 Image quality 66
 Image review 185, 222
 Image size 68
 Image type (Slide show) 223
 Incandescent (White balance) 89
 Index print 210
 In-focus indicator v, 37, 76, 78
 Information 10, 187
 Information display 10, 241
 Interval timer shooting 145
 ISO display and adjustment 239



ISO sensitivity 79, 81
ISO sensitivity settings 81
ISO sensitivity step value 234
i-TTL 119, 122, 247

J

JPEG 66
JPEG basic 66
JPEG compression 67
JPEG fine 66
JPEG normal 66

L

L (large) 68, 167
Landscape (Set Picture Control)
..... 105
Language 265
LCD illumination 3, 241
Lens 26–27, 149, 270, 295
Lens cap 26
Lens focus ring 26, 78, 159
Lens mount 4, 78
Live view 153–160, 161–168
Live view photography 153
Live view selector 153, 161
Lock mirror up for cleaning 315
Long exposure NR 228
Lossless compressed (Type) 67

M

M (medium) 68, 167
Main command dial 13
Manage Picture Control 110
Manual 51, 78
Manual (Flash cntrl for built-in
flash) 246
Manual focus 78, 159
Matrix 83
Max. continuous release 240
Maximum aperture 78, 123, 307
Maximum sensitivity 81
MB-D15 242, 243, 259, 266, 308
MB-D15 battery type 242
Memory buffer 37, 58
Memory card 30, 32, 262, 347, 348
Memory card capacity 348
Metering 83
Microphone 4, 165, 169
Miniature effect 287
Minimum aperture 27, 47
Minimum shutter speed 81
Mired 93
Mirror 61, 127, 315
Mirror up 7, 57, 61
Mode dial 6
Mode dial lock release 6

Modeling flash 251
Monitor 39, 153, 185, 262
Monitor brightness 262
Monitor off delay 238
Monitor pre-flash 122, 125
Monochrome 105, 277
Movie live view 161, 259–260
Movie quality (Movie settings) 169
Movie settings 169
Movie-record button 162
Movies 161, 259–260
Multiple exposure 141
My Menu 291

N

NEF (RAW) 66, 67, 226, 282
NEF (RAW) bit depth 67
NEF (RAW) processing 282
NEF (RAW) recording 67
Network 206, 261
Neutral (Set Picture Control) ... 105
Non-CPU lens 149, 295, 298
Non-CPU lens data 149
Normal-area AF 156
Number of focus points 233
Number of shots 350

O

OK button 252
Optimal quality (JPEG
compression) 67
Optional flash 247, 303
Output resolution (HDMI) 216
Overflow (Role played by card in
Slot 2) 69
Overview data 192

P

Page size (PictBridge) 209
Perspective control 286
Photo information 187, 219
PictBridge 208, 346
Picture Controls 105, 107
Picture size 302
Playback 39, 185
Playback display options 219
Playback folder 217
Playback information 187, 219
Playback menu 217
Playback slot and folder 186
Playback zoom 195
Portrait (Set Picture Control) ... 105
Power connector 308, 311
Power switch 2
Predictive focus tracking 71

Preset manual (White balance)
..... 89, 95
Press the shutter-release button
all the way down 37, 38
Press the shutter-release button
halfway 37, 38
Preview button 50, 255, 260
Print (DPOF) 210
Print select 210
Printing 208
Programmed auto 48
Protecting photographs 196

Q

Quick retouch 284
Quick-response remote (Remote
control mode (ML-L3)) 127
Quiet shutter-release 7, 57

R

Rank items (My Menu) 293
RAW Slot 1 - JPEG Slot 2 (Role
played by card in Slot 2) 69
Rear-curtain sync 121
Recent settings 294
Red intensifier (Filter effects) ... 278
Red-eye correction 276
Red-eye reduction 120, 121
Release button to use dial 258
Release mode 7, 57
Release mode dial 7, 57
Release mode dial lock release
..... 7, 57
Remote control 309
Remote control mode (ML-L3)
..... 127
Remote cord 52, 61, 310
Remote mirror-up (Remote
control mode (ML-L3)) 127
Remote on duration (ML-L3) ... 238
Remove items (My Menu) 292
Removing the lens from the
camera 27
Repeating flash 246
Reset 131, 224, 231
Reset custom settings 231
Reset shooting menu 224
Reset user settings 56
Resize 283
Restoring default settings
..... 131, 224, 231, 324
Retouch menu 273
Reverse indicators 258
RGB 188, 227
Role played by card in Slot 2 69
Rotate tall 222

S

S (small) 68, 167
 Save selected frame 173, 176
 Save user settings 55
 Save/load settings 268
 Saving camera settings 268
 Scene mode 41
 Screen tips 239
 SD memory card
 30, 32, 69, 347, 348
 Select date 199, 210, 218
 Selective color 288
 Self-timer 7, 57, 59, 237
 Sensitivity 79, 81
 Sepia (Monochrome) 277
 Set Picture Control 105
 Setup menu 261
 Shade (White balance) 89
 Shooting data 190
 Shooting menu 224
 Shutter speed 49, 51
 Shutter-priority auto 49
 Shutter-release button
 37, 38, 76, 84, 236, 260
 Shutter-release button AE-L 236
 Side-by-side comparison 290
 Single frame 7, 57
 Single-point AF 73, 74
 Single-servo AF 71, 155, 231
 Size 68, 167
 Size priority (JPEG compression)
 67
 Skylight (Filter effects) 278
 Slide show 223
 Slot 31, 69, 186
 Slot empty release lock 258
 Slow sync 120, 121
 Soft (Filter effects) 278
 Speaker 4, 5
 Speedlight 303
 Spot 83
 sRGB 227
 Standard (Set Picture Control)
 105
 Standard i-TTL flash for digital SLR
 122
 Standby timer 38, 152, 237
 Start printing (PictBridge)
 209, 212
 Storage folder 225
 Straighten 285
 Sub-command dial 13
 Subject-tracking AF 156
 Supported languages 340

T

Television 215
 Thumbnail playback 193
 Time 265
 Time stamp (PictBridge) 209
 Time zone 265
 Time zone and date 265
 Timer 59, 145
 Toning 108, 109
 Trim 277
 Trimming movies 173
 Tripod 4
 Two-button reset 131
 Type D lens 295, 296
 Type G lens 295, 296

U

USB 208
 USB cable 208
 Use GPS to set camera clock 152
 User settings 55
 UTC 152, 191

V

Vibration reduction ON/OFF
 switch 26
 Viewfinder 9, 33, 308, 337
 Viewfinder eyepiece 60
 Viewfinder eyepiece cap 60
 Viewfinder focus 33, 308
 Viewfinder grid display 239
 ViewNX 2 227
 Virtual horizon .. 159, 166, 254, 269
 Vivid (Set Picture Control) 105
 Volume 171

W

Warm filter (Filter effects) 278
 WB 89, 137
 WB bracketing (Auto bracketing
 set) 137, 251
 White balance 89, 137
 Wide-area AF 156
 Wireless mobile adapter 310
 Wireless remote controller 309



No reproduction in any form of this manual, in whole or in part (except for brief quotation in critical articles or reviews), may be made without written authorization from NIKON CORPORATION.

