

Canon

EOS 80D

EOS 80D (W)



Instruction Manual

Instruction manuals (PDF files) and software can be downloaded from the Canon Web site (p.4, 513).

www.canon.com/icpd



Introduction

The EOS 80D (W) is a digital single-lens reflex camera featuring a fine-detail CMOS sensor with approx. 24.2 effective megapixels, DIGIC 6, high-precision and high-speed 45-point AF (Cross-type AF point: Max. 45 points), max. approx. 7.0 fps continuous shooting, Live View shooting, Full High-Definition (Full HD) movie shooting, and wireless functions (Wi-Fi/NFC).

Before Starting to Shoot, Be Sure to Read the Following

To avoid botched pictures and accidents, first read the “Safety Precautions” (p.20-22) and “Handling Precautions” (p.23-25). Also, read this manual carefully to ensure that you use the camera correctly.

Refer to This Manual while Using the Camera to Further Familiarize Yourself with the Camera

While reading this manual, take a few test shots and see how they come out. You can then better understand the camera. Be sure to store this manual safely, too, so that you can refer to it again when necessary.

Testing the Camera Before Use and Liability

After shooting, play images back and check whether they have been properly recorded. If the camera or memory card is faulty and the images cannot be recorded or downloaded to a computer, Canon cannot be held liable for any loss or inconvenience caused.

Copyrights

Copyright laws in your country may prohibit the use of your recorded images or copyrighted music and images with music on the memory card for anything other than private enjoyment. Also be aware that certain public performances, exhibitions, etc., may prohibit photography even for private enjoyment.

Item Check List

Before starting, check that all the following items are included with your camera. If anything is missing, contact your dealer.

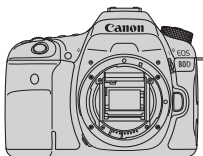

Camera
(with body cap)

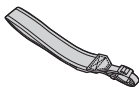

Wide Strap



**Battery Pack
LP-E6N**
(with protective
cover)



**Battery Charger
LC-E6/LC-E6E***

* Battery Charger LC-E6 or LC-E6E is provided. (The LC-E6E comes with a power cord.)

- **The camera does not come with an interface cable or HDMI cable.**
 - The Instruction Manuals provided are listed on the next page.
 - If you purchased a Lens Kit, check that the lenses are included.
 - Depending on the Lens Kit type, lens instruction manuals may also be included.
 - Be careful not to lose any of the above items.
- * For items sold separately, see System Map (p.468).

 When you need Lens Instruction Manuals, download them from the Canon Web site (p.4).
The lens instruction manuals (PDF) are for lenses sold individually. Note that when purchasing the lens kit, some of the accessories included with the lens may not match those listed in the Lens Instruction Manual.

Instruction Manuals



Camera and Wireless Function Basic Instruction Manual

The booklet is the Basic Instruction Manual.

More detailed Instruction Manuals (PDF files) can be downloaded from the Canon Web site.

Downloading and Viewing the Instruction Manuals (PDF Files)

1 Download the Instruction Manuals (PDF files).

- Connect to the Internet and access the following Canon Web site.
www.canon.com/icpd
- Select your country or region of residence and download the Instruction Manuals.

Instruction Manuals Available for Download

- Camera Instruction Manual
- Wireless Function Instruction Manual
- Camera and Wireless Function Basic Instruction Manual
- Lens Instruction Manuals
- Software Instruction Manuals

2 View the Instruction Manuals (PDF files).

- Double-click a downloaded Instruction Manual (PDF file) to open it.
- To view the Instruction Manuals (PDF files), Adobe Acrobat Reader DC or other Adobe PDF viewer (most recent version recommended) is required.
- Adobe Acrobat Reader DC can be downloaded free from the Internet.
- To learn how to use a PDF viewer, refer to its Help section.



Software can be downloaded from the Canon Web site (p.513).

Compatible Cards

The following cards can be used with the camera regardless of capacity: **If the card is new or was previously formatted by another camera or computer, format the card with this camera (p.64).**

- **SD/SDHC*/SDXC* memory cards**

* UHS-I cards supported.

Cards that Can Record Movies

When shooting movies, use a large-capacity card with a reading/writing speed class at least as high as shown in the following table.

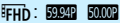
Movie Recording Size (p.306)		Recording Formats	
		MOV	MP4
ALL-I (For editing)		UHS Speed Class 3 or faster	-
IPB (Standard)	 59.94P 50.00P	-	SD Speed Class 10 or faster
	Other than above	-	SD Speed Class 6 or faster
IPB (Light)		-	SD Speed Class 4 or faster

- If you use a slow-writing card when shooting movies, the movie may not be recorded properly. Also, if you play back a movie on a card with a slow reading speed, the movie may not play back properly.
- To check the card's reading/writing speed, refer to the card manufacturer's Web site.



In this manual, "card" refers to SD memory cards, SDHC memory cards, and SDXC memory cards.

* **The camera does not come with a card for recording images/movies.** Please purchase it separately.

Quick Start Guide

1

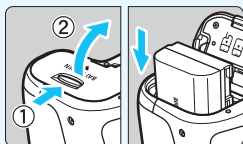

Insert the battery (p.36).

- To charge the battery, see page 34.

2

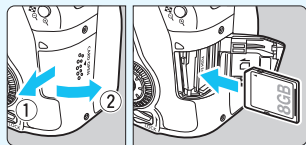

Insert the card (p.37).

- With the card's label facing toward the back of the camera, insert it into the card slot.

3

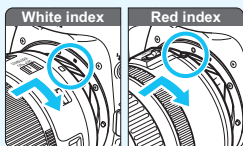

Attach the lens (p.47).

- Align the lens's white or red mount index with the camera's mount index of the same color.

4

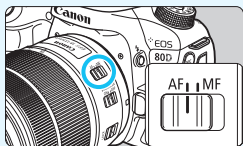

Set the lens's focus mode switch to <AF> (p.47).

5

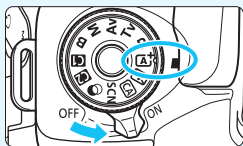

Set the power switch to <ON>, then set the Mode Dial to <A+> (Scene Intelligent Auto) (p.78).

- Turn the Mode Dial while holding down the lock release button at the center.
- All the necessary camera settings will be set automatically.

6

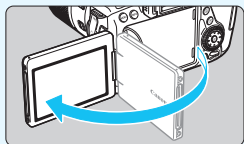
**Flip out the LCD monitor** (p.40).

- When the LCD monitor displays the date/time/zone setting screens, see page 43.

7

**Focus on the subject** (p.50).

- Look through the viewfinder and aim the viewfinder center over the subject.
- Press the shutter button halfway, and the camera will focus on the subject.
- If necessary, the built-in flash will be raised.

8

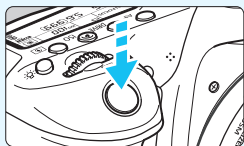
**Take the picture** (p.50).

- Press the shutter button completely to take the picture.





9

**Review the picture.**





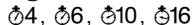

- The captured image will be displayed for approx. 2 sec. on the LCD monitor.
- To display the image again, press the <▶> button (p.346).
- To shoot while looking at the LCD monitor, see “Live View Shooting” (p.255).
- To view the images captured so far, see “Image Playback” (p.346).
- To delete an image, see “Erasing Images” (p.378).

Conventions Used in this Manual

Icons in this Manual

-  : Indicates the Main Dial.
-  : Indicates the Quick Control Dial.
-  : Indicates the Multi-controller and the push direction.
-  : Indicates the Setting button.
-  : Indicates that each function remains active for approx. 4 sec., 6 sec., 10 sec., or 16 sec. after you let go of the button.

* In addition to the above, the icons and symbols used on the camera's buttons and displayed on the LCD monitor are also used in this manual when discussing relevant operations and functionality.

-  : Indicates a function that can be changed by pressing the <MENU> button to change its settings.
-  : When shown on the upper right of a page, it indicates that the function is available only in the Creative Zone modes (p.31).
- (p.**)
-  : Warning to prevent shooting problems.
-  : Supplemental information.
-  : Tips or advice for better shooting.
-  : Troubleshooting advice.

Basic Assumptions

- All operations explained in this manual assume that the power switch is set to <ON> and the <LOCK> switch is set down (Multi function lock released) (p.41, 54).
- It is assumed that all the menu settings and Custom Functions are set to their defaults.
- The illustrations in this manual show the camera attached with the EF-S18-135mm f/3.5-5.6 IS USM lens as an example.



Chapters

	Introduction	2
1	Getting Started	33
2	Basic Shooting	77
3	Setting the AF and Drive Modes	115
4	Image Settings	141
5	Advanced Operations	189
6	Flash Photography	227
7	Shooting with the LCD Monitor (Live View Shooting)	255
8	Shooting Movies	293
9	Image Playback	345
10	Post-Processing Images	389
11	Sensor Cleaning	403
12	Customizing the Camera	409
13	Reference	449
14	Software Start Guide / Downloading Images to a Computer	511

Contents

















Introduction	2
Item Check List.....	3
Instruction Manuals	4
Compatible Cards.....	5
Quick Start Guide	6
Conventions Used in this Manual.....	8
Chapters.....	9
Index to Features	17
Safety Precautions	20
Handling Precautions	23
Nomenclature	26









1 Getting Started **33**

Charging the Battery	34
Installing and Removing the Battery.....	36
Installing and Removing the Card	37
Using the LCD Monitor	40
Turning on the Power	41
Setting the Date, Time, and Zone.....	43
Selecting the Interface Language.....	46
Attaching and Detaching a Lens.....	47
Basic Operation.....	49
 Quick Control for Shooting Functions.....	56
 Menu Operations	58
 Using the Touch Screen	61
Before You Start	64
Formatting the Card.....	64
Disabling the Beeper	66
Setting the Power-off Time/Auto Power Off	66
Setting the Image Review Time	67

Turning the LCD Monitor Off/On	67
Reverting the Camera to the Default Settings.....	68
Displaying the Grid.....	71
 Displaying the Electronic Level	72
Displaying the Flicker Detection.....	74
Feature Guide and Help.....	75







2 Basic Shooting 77

 Fully Automatic Shooting (Scene Intelligent Auto)	78
 Full Auto Techniques (Scene Intelligent Auto).....	81
 Disabling Flash	83
 Creative Auto Shooting.....	84
SCN : Special Scene Mode	88
 Shooting Food	89
 Shooting Children	90
 Shooting Candlelight Portraits	91
 Shooting Night Portraits (With a Tripod)	92
 Shooting Night Scenes (Handheld).....	93
 Shooting Backlit Scenes	94
 Shooting Portraits	95
 Shooting Landscapes	96
 Shooting Close-ups.....	97
 Shooting Moving Subjects	98
 Applying Creative Filters	101
 Quick Control.....	106
Shooting with Ambience Selection.....	108
Shooting by Lighting or Scene Type	112

3	Setting the AF and Drive Modes	115
	AF: Selecting the AF Operation	116
	 Selecting the AF Area and AF Point	120
	AF Area Selection Modes	124
	AF Sensor	127
	Lenses and Usable AF Points	128
	When Autofocus Fails	136
	MF: Manual Focus	137
	 Selecting the Drive Mode	138
	 Using the Self-timer	140
4	Image Settings	141
	Setting the Image-Recording Quality	142
	Changing the Image's Aspect Ratio	146
	ISO: Setting the ISO Speed for Still Photos	148
	 Selecting a Picture Style	154
	 Customizing a Picture Style	157
	 Registering a Picture Style	160
	Setting the White Balance	162
	White Balance	163
	 Setting the Auto White Balance	163
	 Custom White Balance	164
	 Setting the Color Temperature	166
	White Balance Correction	167
	Auto Correction of Brightness and Contrast	169
	Setting Noise Reduction	170
	Highlight Tone Priority	174
	Correction of Lens Peripheral Illumination and Aberrations	175
	Reducing Flicker	179
	Setting the Color Space	181
	Creating and Selecting a Folder	182

File Numbering Methods.....	184
Setting Copyright Information	186



5 Advanced Operations 189

P : Program AE.....	190
Tv : Shutter-Priority AE	192
Av : Aperture-Priority AE.....	194
Depth-of-Field Preview.....	195
M : Manual Exposure.....	196
 Selecting the Metering Mode	198
 Setting Exposure Compensation	200
Auto Exposure Bracketing (AEB).....	201
 AE Lock	203
B : Bulb Exposures	204
HDR : HDR (High Dynamic Range) Shooting.....	207
 Multiple Exposures.....	212
 Mirror Lockup	219
Using the Eyepiece Cover	220
 Using a Remote Switch.....	221
 Remote Control Shooting.....	221
TIMER Interval Timer Shooting	223

6 Flash Photography 227



 Using the Built-in Flash	228
 Using an External Speedlite	233
Setting the Flash	235
Wireless Flash Photography	244

7 Shooting with the LCD Monitor (Live View Shooting) 255











 Shooting with the LCD Monitor	256
Shooting Function Settings	264
 Applying Creative Filters	266













Menu Function Settings.....	270
Selecting the AF Operation	274
Focusing with AF (AF Method).....	276
 Shooting with the Touch Shutter.....	286
MF: Focusing Manually	288

8 Shooting Movies 293

 Shooting Movies.....	294
Shooting Function Settings	304
Setting the Movie Recording Size	306
Using Movie Digital Zoom.....	311
Setting the Sound Recording	312
Shooting HDR Movies	314
 Shooting Movies with Creative Filters.....	316
 Shooting Time-lapse Movies	319
Menu Function Settings.....	326
Shooting Video Snapshots	333

9 Image Playback 345

 Image Playback	346
INFO.: Shooting Information Display	348
 Searching for Images Quickly	353
 /  Magnified View	355
 Playing Back with the Touch Screen	356
 Rotating the Image	358
Setting Ratings	359
 Quick Control for Playback	361
 Enjoying Movies	363
 Playing Back Movies	365
 Editing a Movie's First and Last Scenes	367
Slide Show (Auto Playback)	369

Viewing Images on a TV Set.....	373
 Protecting Images	376
 Erasing Images	378
 Digital Print Order Format (DPOF).....	380
 Specifying Images for a Photobook.....	384
Changing Image Playback Settings	386
Adjusting the LCD Monitor Brightness	386
Auto Rotation of Vertical Images	387
10 Post-Processing Images	389
 Processing RAW Images with the Camera	390
 Resizing JPEG Images	395
 Cropping JPEG Images.....	397
 Applying Creative Filters	399
11 Sensor Cleaning	403
 Automatic Sensor Cleaning.....	404
Appending Dust Delete Data	405
Manual Sensor Cleaning.....	407
12 Customizing the Camera	409
Setting Custom Functions.....	410
Custom Functions	411
Custom Function Settings.....	413
C.Fn I: Exposure	413
C.Fn II: Autofocus	416
C.Fn III: Operation/Others	425
 Fine Adjustment of AF's Point of Focus	427
 Custom Controls	433
Registering My Menu	440
 Registering Custom Shooting Modes.....	445

13	Reference	449
	INFO. Button Functions	450
	Checking the Battery Information	452
	Using a Household Power Outlet	456
	📶 Using Eye-Fi Cards.....	457
	Function Availability Table by Shooting Mode	460
	System Map	468
	Menu Settings	470
	Troubleshooting Guide	481
	Error Codes	496
	Specifications	497
14	Software Start Guide /	
	Downloading Images to a Computer	511
	Software Start Guide	512
	Downloading and Viewing the Software Instruction Manuals (PDF Files) ...	514
	Downloading Images to a Computer	515
	Index.....	517

Index to Features

Power

- Charging the battery → p.34
- Battery level → p.42
- Checking battery information → p.452
- Household power outlet → p.456
- Auto power off → p.66

Cards

- Formatting → p.64
- Release shutter without card → p.38

Lens

- Attaching/Detaching → p.47
- Zoom → p.48

Basic Settings

- Language → p.46
- Date/Time/Zone → p.43
- Beeper → p.66
- Copyright information → p.186
- Clear all camera settings → p.68

Viewfinder

- Dioptic adjustment → p.49
- Eyepiece cover → p.220
- Electronic level → p.73
- Grid → p.71
- Aspect ratio line → p.146

LCD Monitor

- Brightness adjustment → p.386
- Touch screen → p.61
- Electronic level → p.72
- Feature guide → p.75
- Help → p.76

AF

- AF operation → p.116
- AF area selection mode → p.120
- AF point selection → p.122
- Lens group → p.128
- AF points lighting up in red → p.424
- AF Microadjustment → p.427
- Manual focusing → p.137

Metering

- Metering mode → p.198

Drive

- Drive mode → p.138
- Self-timer → p.140
- Maximum burst → p.145

Recording Images

- Creating/Selecting a folder → p.182
- File numbering → p.184

Image Quality

- Image-recording quality → p.142
- ISO speed → p.148
- Picture Style → p.154
- White balance → p.162
- Auto Lighting Optimizer → p.169
- Noise reduction for high ISO speeds → p.170
- Noise reduction for long exposures → p.172
- Highlight tone priority → p.174
- Lens aberration correction → p.175
- Reducing flicker → p.179
- Color space → p.181

Shooting

- Shooting mode → p.30
- HDR Mode → p.207
- Multiple exposures → p.212
- Mirror lockup → p.219
- Bulb timer → p.205
- Interval timer → p.223
- Depth-of-field preview → p.195
- Remote control → p.221
- Quick Control → p.56
- Multi function lock → p.54

Exposure

- Exposure compensation → p.200
- Exposure compensation with M+ISO Auto → p.197
- AEB → p.201
- AE lock → p.203
- Safety shift → p.415

Flash

- Built-in flash → p.228
- External flash → p.233
- Flash function settings → p.235
- Wireless shooting → p.244

Live View Shooting

- Live View shooting → p.255
- AF operation → p.274
- AF method → p.276
- Aspect ratio → p.146
- Creative filters → p.266
- Touch shutter → p.286

Movie Shooting

- Movie shooting → p.293
- AF method → p.276
- Movie Servo AF → p.326
- Movie recording quality → p.306
- Manual exposure → p.298
- Movie digital zoom → p.311
- Sound recording → p.312
- HDR movie shooting → p.314

- Creative filters for movies → p.316
- Video snapshot → p.333
- Time-lapse movie → p.319
- Movie Servo AF speed → p.329
- Movie Servo AF tracking sensitivity → p.330
- Remote control shooting → p.332

Playback

- Image review time → p.67
- Single-image display → p.346
- Shooting information display → p.348
- Index display → p.353
- Image browsing (Jump display) → p.354
- Magnified view → p.355
- Image rotate → p.358
- Rating → p.359
- Movie playback → p.365
- Slide show → p.369
- Viewing images on a TV set → p.373
- Protect → p.376
- Erase → p.378
- Touch playback → p.356
- Print Order (DPOF) → p.380
- Photobook Set-up → p.384

Image Editing

- RAW image processing → p.390
- Resizing JPEGs → p.395
- Cropping JPEGs → p.397
- Creative filters → p.399

Customization

- Custom Functions (C.Fn) → p.410
- Custom Controls → p.433
- My Menu → p.440
- Custom shooting mode → p.445

Sensor Cleaning and Dust Reduction

- Sensor cleaning → p.404
- Append Dust Delete Data → p.405

Software

- Software Start Guide → p.512
- Software Instruction Manuals → p.514

Wireless Functions

- Wireless Function Instruction Manual

Safety Precautions

The following precautions are provided to prevent harm or injury to yourself and others. Make sure to thoroughly understand and follow these precautions before using the product.

If you experience any malfunctions, problems, or damage to the product, contact the nearest Canon Service Center or the dealer from whom you purchased the product.



Warnings: Follow the warnings below. Otherwise, death or serious injuries may result.

- To prevent fire, excessive heat, chemical leakage, explosions, and electrical shock, follow the safeguards below:
 - Do not use any batteries, power sources, or accessories not specified in the Instruction Manual. Do not use any home-made or modified batteries, or the product if it is damaged.
 - Do not short-circuit, disassemble, or modify the battery. Do not apply heat or solder to the battery. Do not expose the battery to fire or water. Do not subject the battery to strong physical shock.
 - Do not insert the battery's plus and minus ends incorrectly.
 - Do not recharge the battery in temperatures outside the allowable charging (working) temperature range. Also, do not exceed the recharging time indicated in the Instruction Manual.
 - Do not insert any foreign metallic objects into the electrical contacts of the camera, accessories, connecting cables, etc.
- When disposing of a battery, insulate the electrical contacts with tape. Contact with other metallic objects or batteries may cause a fire or an explosion.
- If excessive heat, smoke, or fumes are emitted when recharging the battery, immediately unplug the battery charger from the power outlet to stop recharging. Otherwise, it may cause a fire, heat damage, or electrical shock.
- If the battery leaks, changes color, deforms, or emits smoke or fumes, remove it immediately. Be careful not to get burned in the process. It may cause a fire, electrical shock or burns if you keep using it.
- Prevent any battery leakage from contacting your eyes, skin, and clothing. It can cause blindness or skin problems. If the battery leakage comes in contact with your eyes, skin, or clothing, flush the affected area with lots of clean water without rubbing it. See a physician immediately.
- Do not leave any cords near a heat source. It can deform the cord or melt the insulation and cause a fire or electrical shock.
- Do not hold the camera in the same position for long periods of time. Even if the camera does not feel too hot, prolonged contact with the same body part may cause skin redness or blistering due to low-temperature contact burns. Using a tripod is recommended for people with circulation problems or very sensitive skin, or when using the camera in very hot places.
- Do not fire the flash at anyone driving a car or other vehicle. It may cause an accident.

- When the camera or accessories are not in use, make sure to remove the battery, and disconnect the power plug and connecting cables from the equipment before storing. This is to prevent electrical shock, excessive heat, fire, and corrosion.
- Do not use the equipment where there is flammable gas. This is to prevent an explosion or a fire.
- If you drop the equipment and the casing breaks open to expose the internal parts, do not touch the exposed parts. There is a possibility of an electrical shock.
- Do not disassemble or modify the equipment. High-voltage internal parts may cause electrical shock.
- Do not look at the sun or an extremely bright light source through the camera or lens. Doing so may damage your vision.
- Keep equipment out of the reach of children and infants, including when in use. Straps or cords may accidentally cause choking, electrical shock, or injury. Choking or injury may also occur if a child or infant accidentally swallows a camera part or accessory. If a child or infant swallows a part or accessory, consult a physician immediately.
- Do not use or store the equipment in dusty or humid places. Likewise, keep the battery away from metallic items and store it with its protective cover attached to prevent short-circuit. This is to prevent fire, excessive heat, electrical shock, and burns.
- Before using the camera inside an airplane or hospital, check if it is allowed. Electromagnetic waves emitted by the camera may interfere with the plane's instruments or the hospital's medical equipment.
- To prevent a fire and electrical shock, follow the safeguards below:
 - Always insert the power plug all the way in.
 - Do not handle a power plug with wet hands.
 - When unplugging a power plug, grasp and pull the plug instead of the cord.
 - Do not scratch, cut, or excessively bend the cord or put a heavy object on the cord. Also, do not twist or tie the cords.
 - Do not connect too many power plugs to the same power outlet.
 - Do not use a cord whose wire is broken or insulation is damaged.
- Unplug the power plug periodically and clean off the dust around the power outlet with a dry cloth. If the surrounding is dusty, humid, or oily, the dust on the power outlet may become moist and short-circuit the outlet, causing a fire.
- Do not connect the battery directly to an electrical outlet or a car's cigarette lighter outlet. The battery may leak, generate excessive heat or explode, causing fire, burns, or injuries.
- A thorough explanation of how to use the product by an adult is required when the product is used by children. Supervise children while they are using the product. Incorrect usage may result in electrical shock or injury.
- Do not leave a lens or lens-attached camera in the sun without the lens cap attached. Otherwise, the lens may concentrate the sun's rays and cause a fire.
- Do not cover or wrap the product with a cloth. Doing so may trap heat within and cause the casing to deform or catch fire.
- Be careful not to get the camera wet. If you drop the product in the water or if water or metal get inside the product, promptly remove the battery. This is to prevent fire, electrical shock, and burns.
- Do not use paint thinner, benzene, or other organic solvents to clean the product. Doing so may cause fire or a health hazard.



Cautions: Follow the cautions below. Otherwise, physical injury or property damage may result.

- Do not use or store the product in a high-temperature location such as inside a car under the hot sun. The product may become hot and cause burns. Doing so may also cause battery leakage or explosion, which will degrade the performance or shorten the life of the product.
- Do not carry the camera around when it is attached to a tripod. Doing so may cause an injury or an accident. Also make sure the tripod is sturdy enough to support the camera and lens.
- Do not leave the product in a low-temperature environment for an extended period of time. The product will become cold and may cause injury when touched.
- Do not fire the flash near the eyes. It may hurt the eyes.

Handling Precautions

Camera Care

- This camera is a precision instrument. Do not drop it or subject it to physical shock.
- The camera is not waterproof and cannot be used underwater. If you accidentally drop the camera into water, promptly consult the nearest Canon Service Center. Wipe off any water droplets with a dry and clean cloth. If the camera has been exposed to salty air, wipe it with a clean, well-wrung wet cloth.
- Never leave the camera near anything having a strong magnetic field such as a magnet or electric motor. Also, avoid using or leaving the camera near anything emitting strong radio waves, such as a large antenna. Strong magnetic fields can cause camera misoperation or destroy image data.
- Do not leave the camera in excessive heat, such as in a car in direct sunlight. High temperatures can cause the camera to malfunction.
- The camera contains precision electronic circuitry. Never attempt to disassemble the camera yourself.
- Do not block the built-in flash or mirror operation with your finger, etc. Doing so may cause a malfunction.
- Use only a commercially-available blower to blow away dust when it adheres to the lens, viewfinder, reflex mirror, focusing screen, etc. Do not use cleaners that contain organic solvents to clean the camera body or lens. For stubborn dirt, take the camera to the nearest Canon Service Center.
- Do not touch the camera's electrical contacts with your fingers. This is to prevent the contacts from corroding. Corroded contacts may cause camera malfunction.
- If the camera is suddenly brought in from the cold into a warm room, condensation may form on the camera and internal parts. To prevent condensation, first put the camera in a sealed plastic bag and let it adjust to the warmer temperature before taking it out of the bag.

- If condensation forms on the camera, do not use the camera. This is to avoid damaging the camera. If there is condensation, remove the lens, card and battery from the camera, and wait until condensation has evaporated before using the camera.
- If the camera will not be used for an extended period, remove the battery and store the camera in a cool, dry, well-ventilated location. Even while the camera is in storage, press the shutter button a few times once in a while to check that the camera is still working.
- Avoid storing the camera where there are chemicals that result in rust and corrosion such as in a chemical lab.
- If the camera has not been used for an extended period, test all its functions before using it. If you have not used the camera for some time or if there is an important shoot such as a foreign trip coming up, have the camera checked by your nearest Canon Service Center or check the camera yourself and make sure it is working properly.
- If you use continuous shooting, Live View shooting, or movie shooting for a prolonged period, the camera may become hot. This is not a malfunction.
- If there is a bright light source inside or outside the image area, ghosting may occur.

LCD Panel and LCD Monitor

- Although the LCD monitor is manufactured with very high precision technology with over 99.99% effective pixels, there may be a few dead pixels displaying only black or red, etc. among the remaining 0.01% or less pixels. Dead pixels are not a malfunction. They do not affect the images recorded.
- If the LCD monitor is left on for a prolonged period, screen burn-in may occur where you see remnants of what was displayed. However, this is only temporary and will disappear when the camera is left unused for a few days.
- The LCD monitor display may seem slow in low temperatures, or look black in high temperatures. It will return to normal at room temperature.

Cards

To protect the card and its recorded data, note the following:

- Do not drop, bend, or wet the card. Do not subject it to excessive force, physical shock, or vibration.
- Do not touch the card's electronic contacts with your fingers or anything metallic.
- Do not affix any stickers, etc., on the card.
- Do not store or use the card near anything that has a strong magnetic field, such as a TV set, speakers, or magnets. Also avoid places prone to having static electricity.
- Do not leave the card in direct sunlight or near a heat source.
- Store the card in a case, etc.
- Do not store the card in hot, dusty, or humid locations.

Lens

After detaching the lens from the camera, put down the lens with the rear end up and attach the rear lens cap to avoid scratching the lens surface and electrical contacts.

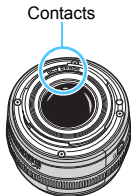

Nomenclature

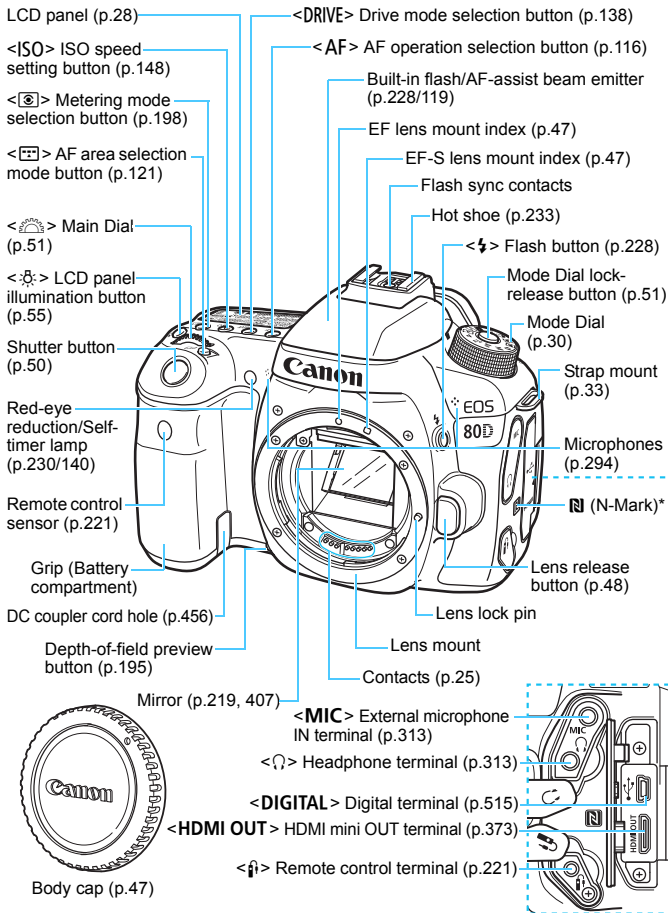

* Used for wireless connections via the NFC function.

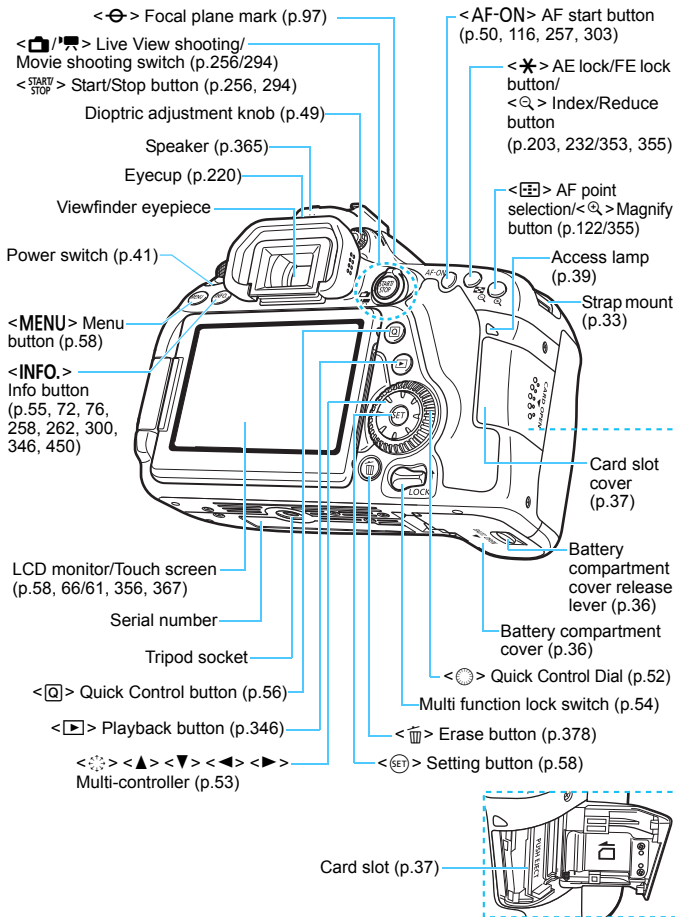

LCD Panel

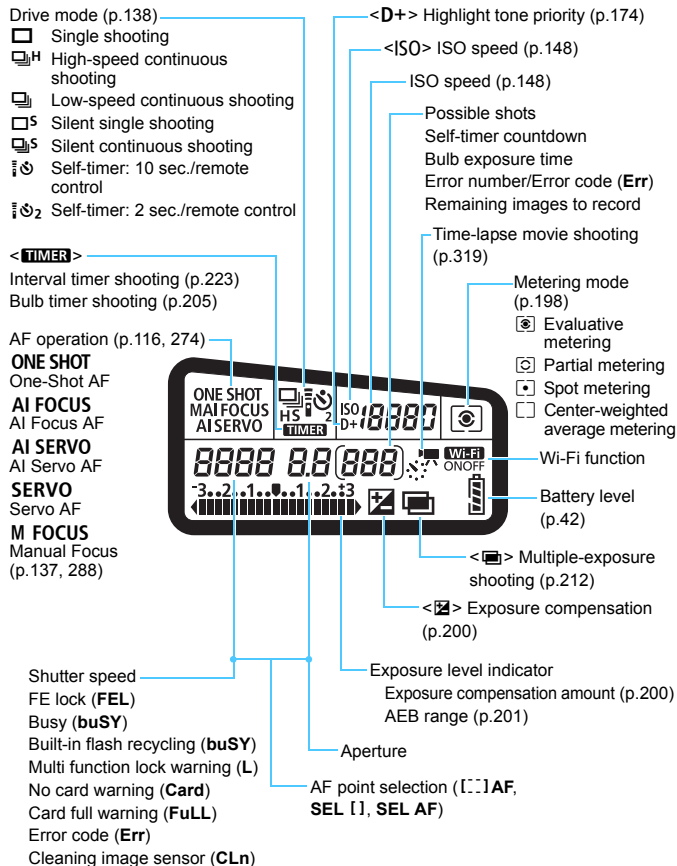

● The display will show only the settings currently applied.

Viewfinder Information

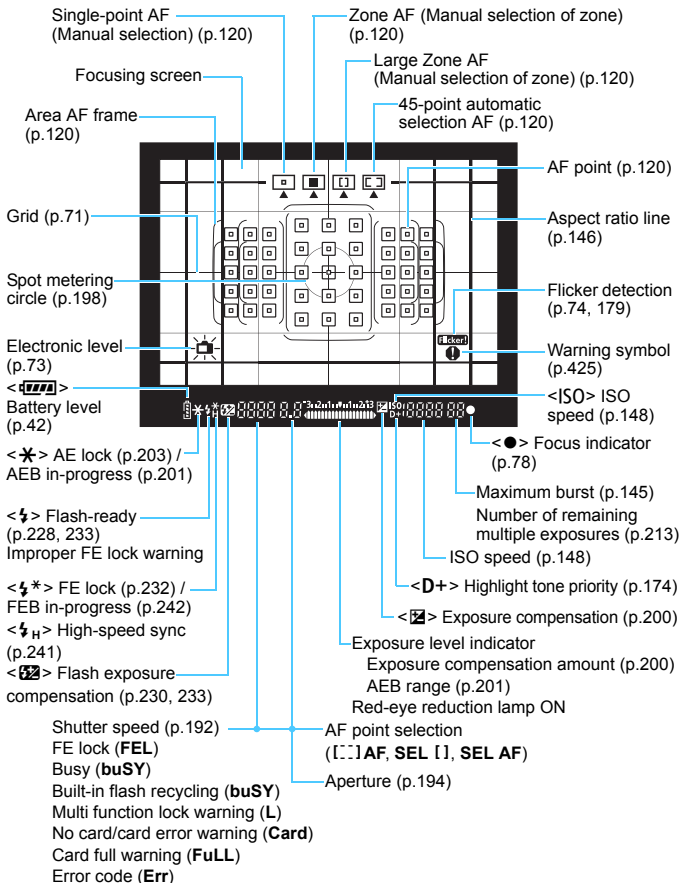

- The display will show only the settings currently applied.

Mode Dial

Turn the Mode Dial while holding down the Mode Dial center (Mode Dial lock-release button).



Basic Zone

All you do is press the shutter button. The camera sets everything to suit the subject or scene for shooting.

A+ : Scene Intelligent Auto (p.78)

Flash Off (p.83)

CA : Creative Auto (p.84)

SCN : Special scene (p.88)

	Food (p.89)		HDR Backlight Control (p.94)
	Kids (p.90)		Portrait (p.95)
	Candlelight (p.91)		Landscape (p.96)
	Night Portrait (p.92)		Close-up (p.97)
	Handheld Night Scene (p.93)		Sports (p.98)

Creative filters (p.101)

	Grainy B/W (p.103)		Water painting effect (p.104)
	Soft focus (p.103)		HDR art standard (p.104)
	Fish-eye effect (p.104)		HDR art vivid (p.105)
	Toy camera effect (p.104)		HDR art bold (p.105)
	Miniature effect (p.104)		HDR art embossed (p.105)

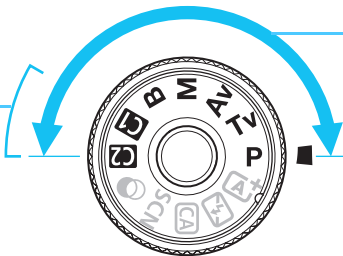

Creative Zone

These modes give you more control for shooting various subjects as desired.

P : Program AE (p.190)



Tv : Shutter-priority AE (p.192)

Av : Aperture-priority AE (p.194)

M : Manual exposure (p.196)

B : Bulb (p.204)

Custom shooting mode

You can register the shooting mode (**P/Tv/Av/M/B**), AF operation, menu settings, etc., to ,  Mode Dial positions (p.445).

Battery Charger LC-E6

Charger for Battery Pack LP-E6N/LP-E6 (p.34).

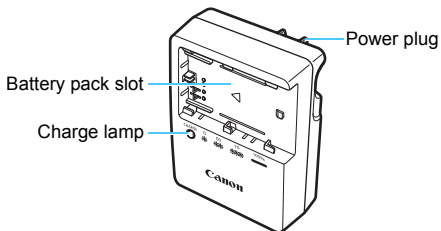

**IMPORTANT SAFETY INSTRUCTIONS-SAVE THESE INSTRUCTIONS.
DANGER-TO REDUCE THE RISK OF FIRE OR ELECTRIC SHOCK,
CAREFULLY FOLLOW THESE INSTRUCTIONS.**

For connection to a supply not in the U.S.A., use an attachment plug adapter of the proper configuration for the power outlet, if needed.

Battery Charger LC-E6E

Charger for Battery Pack LP-E6N/LP-E6 (p.34).

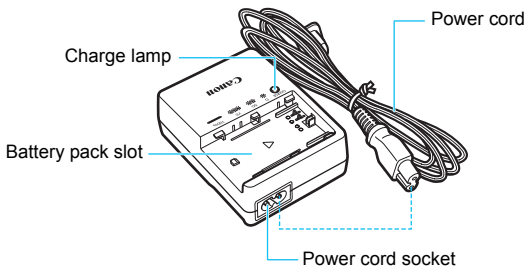

1

Getting Started

This chapter explains preparatory steps before you start shooting and basic camera operations.

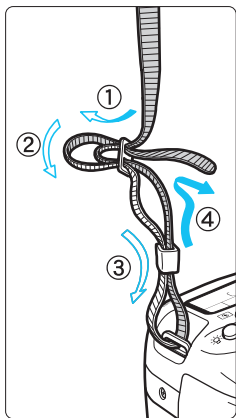

Attaching the Strap

Pass the end of the strap through the camera's strap mount eyelet from the bottom. Then pass it through the strap's buckle as shown in the illustration. Pull the strap to take up any slack and make sure the strap will not loosen from the buckle.

- The eyepiece cover is attached to the strap (p.220).

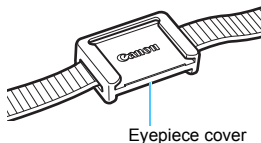

Charging the Battery

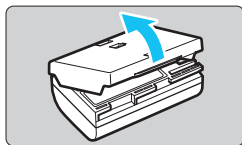

1 Remove the protective cover.

- Detach the protective cover provided with the battery.

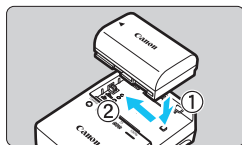

2 Attach the battery.

- As shown in the illustration, attach the battery securely to the charger.
- To detach the battery, follow the above procedure in reverse.

LC-E6

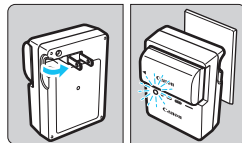

3 Recharge the battery.

For LC-E6

- As shown by the arrow, flip out the battery charger's prongs and insert the prongs into a power outlet.

LC-E6E

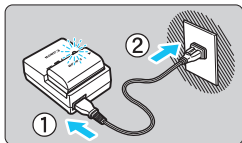

For LC-E6E

- Connect the power cord to the charger and insert the plug into a power outlet.
- ▶ Recharging starts automatically and the charge lamp blinks in orange.

Charge Level	Charge lamp	
	Color	Display
0-49%	Orange	Blinks once per second
50-74%		Blinks twice per second
75% or higher		Blinks three times per second
Fully charged	Green	Lights up

- **It takes approx. 2 hr. and 30 min. to fully recharge a completely exhausted battery at room temperature (23°C / 73°F).** The time required to recharge the battery will vary greatly depending on the ambient temperature and the battery's remaining capacity.
- For safety reasons, recharging in low temperatures (5°C - 10°C / 41°F - 50°F) will take longer (up to approx. 4 hr.).



Tips for Using the Battery and Charger

- **Upon purchase, the battery is not fully charged.**
Charge the battery before use.
- **Recharge the battery on the day before or on the day it is to be used.**
Even during storage, a charged battery will gradually drain and lose its capacity.
- **After recharging the battery, detach it and disconnect the charger from the power outlet.**
- **You can attach the cover in a different orientation to indicate whether the battery has been recharged or not.**

If the battery has been recharged, attach the cover so that the battery-shaped hole is aligned over the blue sticker on the battery. If the battery is exhausted, attach the cover in the opposite orientation.

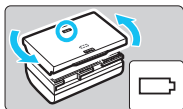

- **When not using the camera, remove the battery.**
If the battery is left in the camera for a prolonged period, a small amount of power current is released, resulting in excess discharge and shorter battery life. Store the battery with the protective cover attached. Storing the battery when it is fully charged may lower the battery's performance.
- **The battery charger can also be used in foreign countries.**
The battery charger is compatible with a 100 V AC to 240 V AC 50/60 Hz power source. If necessary, attach a commercially-available plug adapter for the respective country or region. Do not attach any portable voltage transformer to the battery charger. Doing so can damage the battery charger.
- **If the battery becomes exhausted quickly even after being fully charged, the battery has reached the end of its service life.**
Check the battery's recharge performance (p.452) and purchase a new battery.



- After disconnecting the charger's power plug, do not touch the prongs for approx. 10 sec.
- If the battery's remaining capacity (p.452) is 94% or higher, the battery will not be recharged.
- The charger cannot charge any battery other than Battery Pack LP-E6N/LP-E6.

Installing and Removing the Battery

Load a fully-charged Battery Pack LP-E6N (or LP-E6) into the camera. The camera's viewfinder becomes bright when a battery is installed, and darkens when the battery is removed. If the battery is not installed, the picture in the viewfinder becomes blurred and focus cannot be achieved.

Installing the Battery

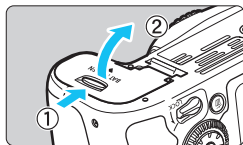

1 Open the cover.

- Slide the lever as shown by the arrows and open the cover.

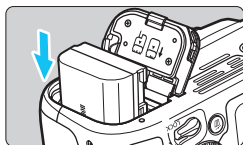

2 Insert the battery.

- Insert the end with the electrical contacts.
- Insert the battery until it locks in place.

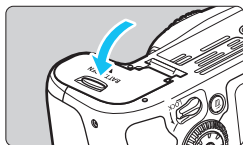

3 Close the cover.

- Press the cover until it snaps shut.

 Only Battery Pack LP-E6N/LP-E6 can be used.

Removing the Battery

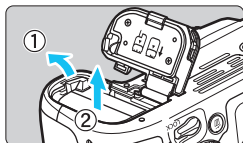

Open the cover and remove the battery.

- Press the battery lock lever as shown by the arrow and remove the battery.
- To prevent short circuiting of the electrical contacts, be sure to attach the provided protective cover (p.34) to the battery.

Installing and Removing the Card

You can use an SD, SDHC, or SDXC memory card (sold separately) with the camera. SDHC and SDXC memory cards with UHS-I can also be used. The captured images are recorded onto the card.

- **Make sure the card's write-protect switch is set upward to enable writing and erasing.**

Installing the Card

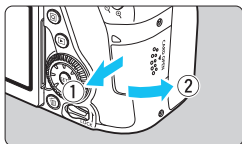

1 Open the cover.

- Slide the cover as shown by the arrows to open it.

Write-protect switch

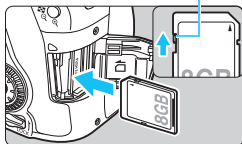

2 Insert the card.

- As shown by the illustration, face the card's label side toward you and insert it until it clicks in place.

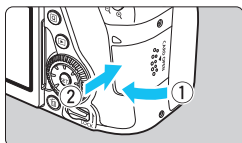

3 Close the cover.

- Close the cover and slide it in the direction shown by the arrows until it snaps shut.
- When you set the power switch to <ON>, the number of possible shots will be displayed on the LCD panel.



Possible shots

- The number of possible shots depends on the remaining capacity of the card, image-recording quality, ISO speed, etc.
- Setting [ 1: Release shutter without card] to [Disable] will prevent you from shooting without a card inserted (p.470).

Removing the Card

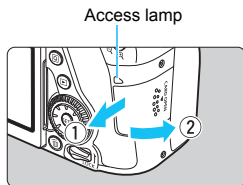

1 Open the cover.

- Set the power switch to <OFF>.
- **Make sure the access lamp is off, then open the cover.**
- If [Recording...] is displayed, close the cover.

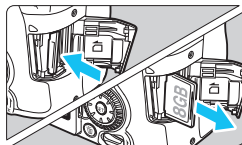

2 Remove the card.

- Gently push in the card, then let go to eject it.
- Pull the card straight out, then close the cover.



- **When the access lamp is lit or blinking, it indicates that images are being written to, read from, or erased from the card, or data is being transferred. Do not open the card slot cover during this time. Also, never do any of the following while the access lamp is lit or blinking. Otherwise, it can damage the image data, card, or camera.**
 - **Removing the card.**
 - **Removing the battery.**
 - **Shaking or banging the camera around.**
 - **Unplugging and connecting a power cord** (when household power outlet accessories (sold separately, p.456) are used).
- If the card already contains recorded images, the image number may not start from 0001 (p.184).
- If a card-related error message is displayed on the LCD monitor, remove and reinsert the card. If the error persists, use a different card. If you can transfer all the images on the card to a computer, transfer all the images and then format the card with the camera (p.64). The card may then return to normal.
- Do not touch the card's contacts with your fingers or metal objects. Do not expose the contacts to dust or water. If a smudge adheres to the contacts, contact failure may result.
- Multimedia cards (MMC) cannot be used (card error will be displayed).

Using the LCD Monitor

After you flip out the LCD monitor, you can set menu functions, use Live View shooting, shoot movies, or play back images and movies. You can change the direction and angle of the LCD monitor.

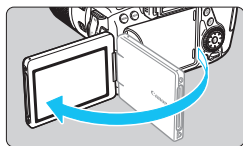

1 Flip out the LCD monitor.

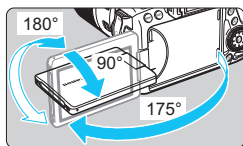

2 Rotate the LCD monitor.

- When the LCD monitor is swung out, you can rotate it up, down, or over 180° to face the subject.
- The indicated angle is only approximate.

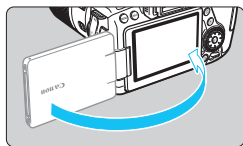

3 Face it toward you.

- Normally, use the camera with the LCD monitor facing you.

 Be careful not to force and break the hinge when rotating the LCD monitor.

-  • When not using the camera, close the LCD monitor with the screen facing inward. This will protect the screen.
- During Live View shooting or movie shooting, facing the LCD monitor toward the subject will display a mirror image on the screen (right/left reversed).

Turning on the Power

If you turn on the power switch and the date/time/zone setting screen appears, see page 43 to set the date/time/zone.

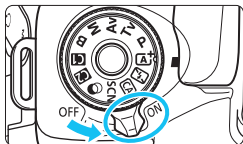

- <ON> : The camera turns on.
- <OFF> : The camera is turned off and does not function. Set to this position when not using the camera.

Automatic Sensor Cleaning

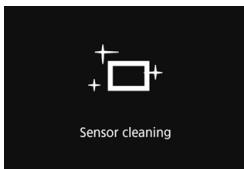

- Whenever you set the power switch to <ON> or <OFF>, sensor cleaning will be performed automatically. (A small sound may be heard.) During the sensor cleaning, the LCD monitor will display <+□+>.

- You can still shoot during sensor cleaning by pressing the shutter button halfway (p.50) to stop cleaning and take a picture.
- If you repeatedly turn the power switch <ON>/<OFF> at a short interval, the <+□+> icon may not be displayed. This is normal and not a malfunction.

MENU Auto Power Off

- To save battery power, the camera turns off automatically after approx. 1 minute of non-operation. To turn on the camera again, just press the shutter button halfway (p.50).
- You can change the auto power off time with [**2**: Auto power off] (p.66).







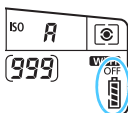

If you set the power switch to <OFF> while an image is being recorded to the card, [Recording...] will be displayed and the power will turn off after the recording finishes.

Battery Level Indicator

When the power switch is set to <ON>, the battery level will be indicated in one of six levels. A blinking battery icon () indicates that the battery will be exhausted soon.



Display						
Level (%)	100 - 70	69 - 50	49 - 20	19 - 10	9 - 1	0



Number of Possible Shots

(Approx. number of shots)

Temperature	Room Temperature (23°C / 73°F)	Low Temperatures (0°C / 32°F)
No Flash	1390	1250
50% Flash Use	960	860

- The figures above are based on a fully-charged Battery Pack LP-E6N, no Live View shooting, and CIPA (Camera & Imaging Products Association) testing standards.
- Possible shots with Battery Grip BG-E14 (sold separately)
 - With LP-E6N x 2: approx. twice the shots without the battery grip.
 - With AA/LR6 alkaline batteries at room temperature (23°C / 73°F): approx. 560 shots with no flash, approx. 400 shots with 50% flash use.



- Doing any of the following will exhaust the battery sooner:
 - Pressing the shutter button halfway for a prolonged period.
 - Activating the AF frequently without taking a picture.
 - Using the lens Image Stabilizer.
 - Using the LCD monitor frequently.
- The number of possible shots may decrease depending on the actual shooting conditions.
- The lens operation is powered by the camera's battery. Depending on the lens used, the battery power may exhaust faster.
- For the number of possible shots with Live View shooting, see page 257.
- See [**3: Battery info.**] to check the battery condition in detail (p.452).
- With Battery Grip BG-E14 (sold separately) loaded with AA/R6 batteries, a four-level indicator will be displayed. (/) will not be displayed.)

MENU Setting the Date, Time, and Zone

When you turn on the power for the first time or if the date/time/zone have been reset, the date/time/zone setting screen will appear. Follow the steps below to set the time zone first. Set the camera to the time zone in which you currently live so that, when you travel, you can simply change the setting to the correct time zone for your destination, and the camera will automatically adjust the date/time.

Note that the date/time appended to recorded images will be based on this date/time setting. Be sure to set the correct date/time.



1 Display the menu screen.

- Press the <MENU> button to display the menu screen.

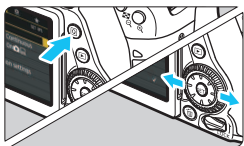

2 Under the [Q] tab, select [Date/Time/Zone].

- Press the <Q> button and select the [Q] tab.
- Press the <◀> <▶> keys to select the [Q] tab.
- Press the <▲> <▼> keys to select [Date/Time/Zone], then press <SET>.

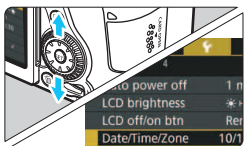

3 Set the time zone.

- [London] is set by default.
- Press the <◀> <▶> keys to select [Time zone], then press <SET>.



- The menu setting procedure is explained on page 58.
- In step 3, the time displayed in [Time zone] is the time difference compared with Coordinated Universal Time (UTC).

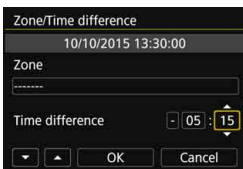
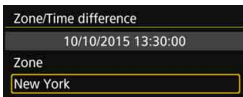

- Select the [**Zone**] box, then press $\langle \text{SET} \rangle$.
- Press the $\langle \blacktriangle \rangle$ $\langle \blacktriangledown \rangle$ keys to select the time zone, then press $\langle \text{SET} \rangle$.
- If you do not see your time zone, you can also set the time difference with UTC directly. In such a case, press the $\langle \blacktriangleleft \rangle$ $\langle \blacktriangleright \rangle$ keys to select the [**Time difference**] box, then press $\langle \text{SET} \rangle$ so $\langle \square \rangle$ is displayed.
- Press the $\langle \blacktriangle \rangle$ $\langle \blacktriangledown \rangle$ keys to set, then press $\langle \text{SET} \rangle$. (Returns to $\langle \square \rangle$.)
- After setting, press the $\langle \blacktriangleleft \rangle$ $\langle \blacktriangleright \rangle$ keys to select [**OK**], then press $\langle \text{SET} \rangle$. The previous screen will reappear.

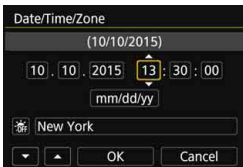

4 Set the date and time.

- Press the $\langle \blacktriangleleft \rangle$ $\langle \blacktriangleright \rangle$ keys to select the number.
- Press $\langle \text{SET} \rangle$ so $\langle \square \rangle$ is displayed.
- Press the $\langle \blacktriangle \rangle$ $\langle \blacktriangledown \rangle$ keys to set, then press $\langle \text{SET} \rangle$. (Returns to $\langle \square \rangle$.)

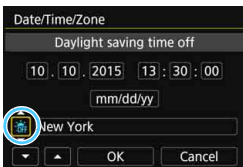

5 Set the daylight saving time.

- Set it if necessary.
- Press the $\langle \blacktriangleleft \rangle$ $\langle \blacktriangleright \rangle$ keys to select [☀].
- Press $\langle \text{SET} \rangle$ so $\langle \square \rangle$ is displayed.
- Press the $\langle \blacktriangle \rangle$ $\langle \blacktriangledown \rangle$ keys to select [☀], then press $\langle \text{SET} \rangle$.
- When the daylight saving time is set to [☀], the time set in step 4 will advance by 1 hour. If [☀] is set, the daylight saving time will be canceled and the time will go back by 1 hour.

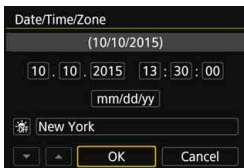

6 Exit the setting.

- Press the <◀> <▶> keys to select **[OK]**, then press <SET>.
- ▶ The date/time/zone and daylight saving time will be set and the menu will reappear.

 The date/time/zone settings may be reset in the following cases. If this happens, set the date/time/zone again.

- When the camera is stored without the battery.
- When the camera's battery becomes exhausted.
- When the camera is exposed to below freezing temperatures for a prolonged period.



- The date/time that were set will start when you select **[OK]** in step 6.
- After changing the time zone or time difference setting, check that the correct date and time are set.

MENU Selecting the Interface Language

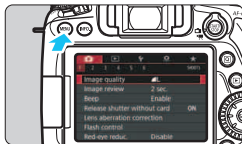

1 Display the menu screen.

- Press the <MENU> button to display the menu screen.

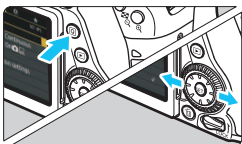

2 Under the [Fn] tab, select [Language].

- Press the <Q> button and select the [Fn] tab.
- Press the <◀> <▶> keys to select the [Fn] tab.
- Press the <▲> <▼> keys to select the [Language], then press <SET>.

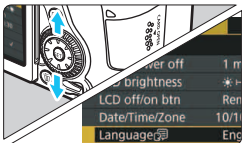

3 Set the desired language.

- Press the <▲> <▼> keys to select the language, then press <SET>.
- ▶ The interface language will change.



Attaching and Detaching a Lens

The camera is compatible with all Canon EF and EF-S lenses. **The camera cannot be used with EF-M lenses.**

Attaching a Lens

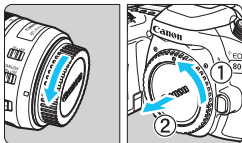

1 Remove the caps.

- Remove the rear lens cap and the body cap by turning them as shown by the arrows.

White index

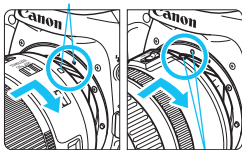

2 Attach the lens.

- Align the lens's red or white index with the camera's index matching the same color. Turn the lens as shown by the arrow until it clicks in place.

Red index

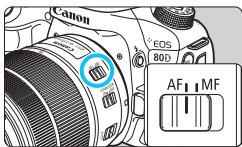

3 Set the lens's focus mode switch to <AF>.

- <AF> stands for autofocus.
- If it is set to <MF> (manual focus), autofocus will not operate.

4 Remove the front lens cap.

Minimizing Dust

- When changing lenses, do it quickly in a place with minimal dust.
- When storing the camera without a lens attached, be sure to attach the body cap to the camera.
- Remove dust on the body cap before attaching it.

Zooming

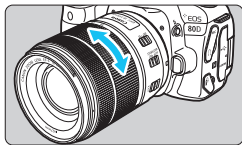

Turn the zoom ring on the lens with your fingers.

- If you want to zoom, do it before focusing. Turning the zoom ring after achieving focus may throw off the focus.

Detaching the Lens

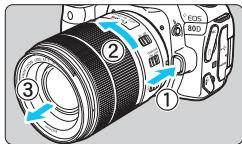

While pressing the lens release button, turn the lens as shown by the arrow.

- Turn the lens until it stops, then detach it.
- Attach the rear lens cap to the detached lens.

- Do not look at the sun directly through any lens. Doing so may cause loss of vision.
- **When attaching or detaching a lens, set the camera's power switch to <OFF>.**
- If the front part (focusing ring) of the lens rotates during autofocus, do not touch the rotating part.

Angle of View

Since the image sensor size is smaller than the 35mm film format, the effective angle of view of an attached lens will be equivalent to that of a lens with approx. 1.6x of the focal length indicated.

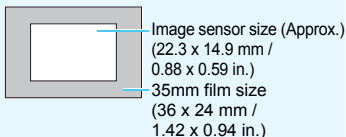

Basic Operation

Adjusting the Viewfinder Clarity

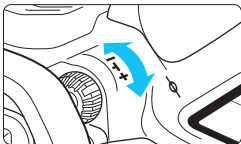

Turn the dioptic adjustment knob.

- Turn the knob left or right so that the AF points in the viewfinder look the sharpest.
- If the knob is difficult to turn, remove the eyecup (p.220).



If the camera dioptic adjustment still cannot provide a sharp viewfinder image, using E-series Dioptic Adjustment Lenses (sold separately) is recommended.

Holding the Camera

To obtain sharp images, hold the camera still to minimize camera shake.

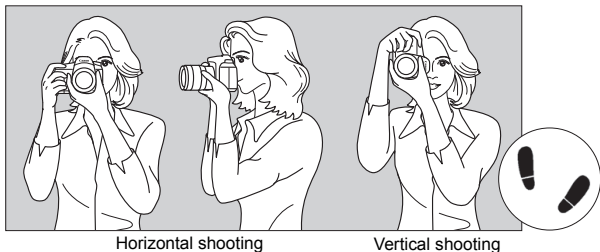

Horizontal shooting

Vertical shooting

1. Wrap your right hand around the camera grip firmly.
2. Hold the lens bottom with your left hand.
3. Rest your hand's right index finger lightly on the shutter button.
4. Press your arms and elbows lightly against the front of your body.
5. To maintain a stable stance, place one foot slightly ahead of the other.
6. Press the camera against your face and look through the viewfinder.



To shoot while looking at the LCD monitor, see pages 82 and 255.

Shutter Button

The shutter button has two steps. You can press the shutter button halfway. Then you can further press the shutter button completely.

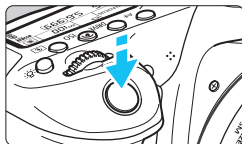

Pressing Halfway

This activates autofocus and the automatic exposure system that sets the shutter speed and aperture.

The exposure setting (shutter speed and aperture) is displayed in the viewfinder and on the LCD panel (📷4).



Pressing Completely

This releases the shutter and takes the picture.

Preventing Camera Shake

Hand-held camera movement during the moment of exposure is called camera shake. It can cause blurred pictures. To prevent camera shake, note the following:

- Hold and steady the camera as shown on the preceding page.
- Press the shutter button halfway to autofocus, then slowly press the shutter button completely.



- In Creative Zone modes, pressing the <AF-ON> button is the same as pressing the shutter button halfway.
- If you press the shutter button completely without pressing it halfway first, or if you press the shutter button halfway and then press it completely immediately, the camera will take a moment before it takes the picture.
- Even during menu display, image playback, or image recording, you can go back to shooting-ready by pressing the shutter button halfway.

Mode Dial

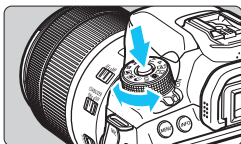



Turn the dial while holding down the lock release button at the center of the dial.



Use it to set the shooting mode.

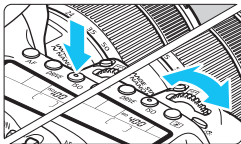

Main Dial



- (1) After pressing a button, turn the <  > dial.**

When you press a button such as <AF> <DRIVE> <ISO> <>, the respective function remains selected for the duration of the timer (06). During this time, you can turn the <  > dial to set the desired setting.

When the function selection ends or if you press the shutter button halfway, the camera will be ready to shoot.

- Use this dial to select or set the AF operation, drive mode, ISO speed, metering mode, AF point selection, etc.

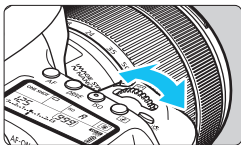

- (2) Turn the <  > dial only.**

While looking at the viewfinder or LCD panel, turn the <  > dial to change the setting.

- Use this dial to set the shutter speed, aperture, etc.



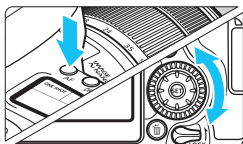

The operations in (1) are possible even when the <LOCK> switch is set upward (Multi function lock, p.54).

Quick Control Dial



(1) After pressing a button, turn the dial.

When you press a button such as **<AF>** **<DRIVE>** **<ISO>** **<>**, the respective function remains selected for the duration of the timer (). During this time, you can turn the  dial to set the desired setting.

When the function selection ends or if you press the shutter button halfway, the camera will be ready to shoot.

- Use this dial to select or set the AF operation, drive mode, ISO speed, metering mode, AF point selection, etc.

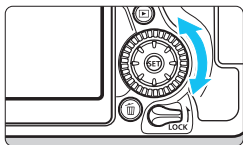

(2) Turn the dial only.

While looking at the viewfinder or LCD panel, turn the  dial to change the setting.





- Use this dial to set the exposure compensation amount, the aperture setting for manual exposures, etc.

 The operations in (1) are possible even when the **<LOCK>** switch is set upward (Multi function lock, p.54).

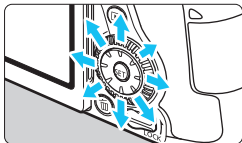
Multi-controller

The Multi-controller <> has eight keys that tilt in the directions shown by the arrows.



- Use the eight keys to select the AF point, correct the white balance, move the AF point or magnifying frame during Live View shooting or movie shooting, or scroll around magnified images during playback.
- For menus and the Quick Control, the Multi-controller works only in the vertical and horizontal directions < > < > < > < >. It does not work in diagonal directions.



AF point selection, white balance correction, and scrolling around magnified images during playback are possible even when the <**LOCK**> switch is set upward (Multi function lock, p.54).

LOCK Multi Function Lock

With [**F4**: Multi function lock] set and the <**LOCK**> switch set upward, the camera prevents you from changing settings inadvertently by moving the Main Dial, Quick Control Dial, and Multi-controller or by touching the touch panel.

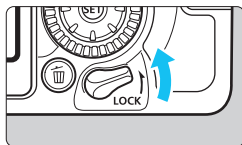

<**LOCK**> switch set downward: Lock released

<**LOCK**> switch set upward: Lock engaged

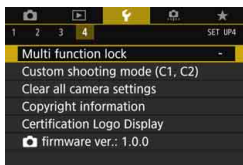

1 Select [Multi function lock].

- Under the [**F4**] tab, select [**Multi function lock**], then press <**SET**>.

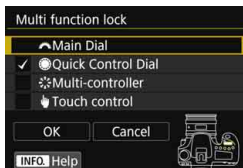





2 Add a checkmark [✓] to the camera control to be locked.

- Select a camera control and press <**SET**> to add a checkmark [✓].
- Select [**OK**].
- The selected camera controls will be locked when the multi function lock switch is in the locked position.

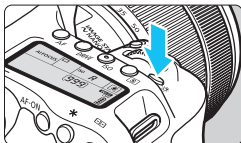
- If the <**LOCK**> switch is set upward and you try to use one of the locked camera controls (except when [**Touch control**] is set), <**L**> will be displayed in the viewfinder and on the LCD panel. On the shooting function settings display (p.55), [**LOCK**] will be displayed. During Live View shooting, [**LOCK**] will be displayed on the LCD monitor.
- By default, when locked, the <**SET**> dial will be locked.
- In Basic Zone modes, only [**Touch control**] is settable.

LCD Panel Illumination



You can illuminate the LCD panel by pressing the  button. Turn on () or off the LCD panel illumination by pressing the  button.



During a bulb exposure, pressing the shutter button completely will turn off the LCD panel illumination.

Displaying Shooting Function Settings

After you press the **<INFO.>** button a number of times, the shooting function settings will be displayed.

With the shooting function settings displayed, you can turn the Mode Dial to see the settings for each shooting mode (p.451).

Pressing the **<Q>** button enables Quick Control of the shooting function settings (p.56).

Press the **<INFO.>** button again to turn off the display.



Q Quick Control for Shooting Functions

You can directly select and set the shooting functions displayed on the LCD monitor. This is called Quick Control.

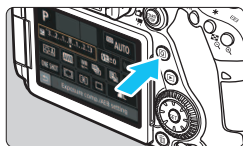

1 Press the **<Q>** button (10).

- ▶ The Quick Control screen will appear.

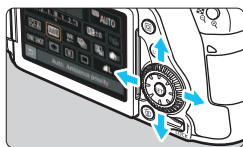

2 Set the desired function.

- Press the **<▲>** **<▼>** or **<◀>** **<▶>** keys to select a function.
- ▶ The settings of the selected function and Feature guide (p.75) will appear.
- Turn the **<☀>** or **<☺>** dial to change the setting.

Basic Zone modes

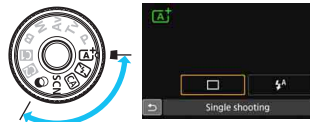

Creative Zone modes



3 Take the picture.

- Press the shutter button completely to take the picture.
- ▶ The captured image will be displayed.

- For the functions settable in Basic Zone modes and their setting procedures, see page 107.
- In steps 1 and 2, you can also use the LCD monitor's touch screen (p.61).

Sample Quick Control Screen

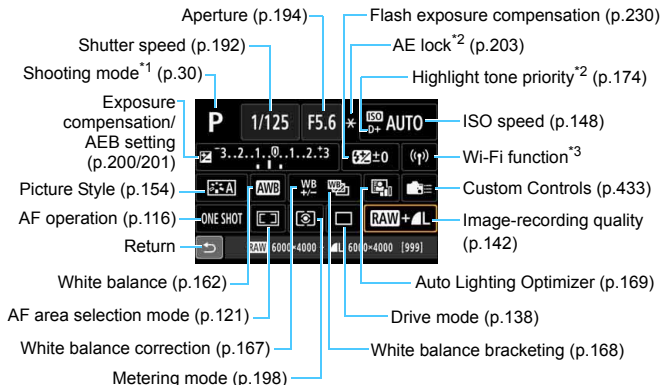

- *1 : Settable only when the Mode Dial is set to <SCN> or <P>.
- *2 : These functions cannot be set with Quick Control.
- *3 : Refer to the Wireless Function Instruction Manual.

Quick Control

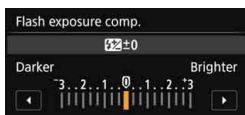

- Select the desired function and press <SET>. The function's setting screen will appear.
- Turn the <INFO.> or <MENU> dial or press the <◀> <▶> keys to change the settings. There are also some functions that are set by pressing the <INFO.>, <INFO.>, or <INFO.> button.
- Press <SET> to finalize the setting and return to the Quick Control screen.
- When you select <CUSTOM> (p.433) or <INFO.> (p.120) and press the <MENU> button, the previous screen will reappear.

MENU Menu Operations

You can set various settings with the menus such as the image-recording quality, date and time, etc.

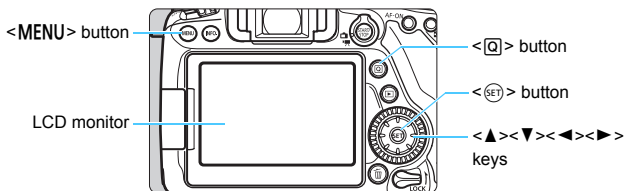

Menus in Basic Zone Modes

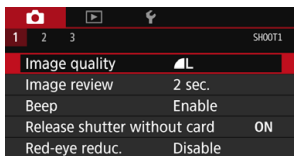
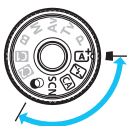

* Some menu tabs and menu items are not displayed in Basic Zone modes.

Menus in Creative Zone Modes

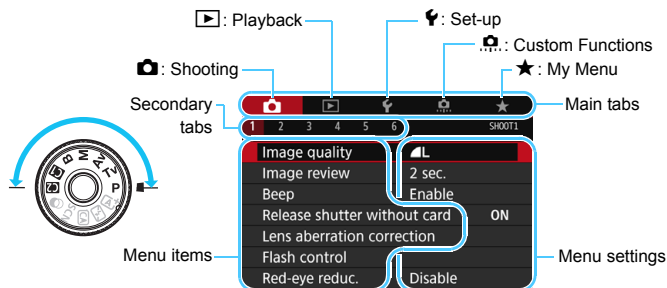

Menu Setting Procedure

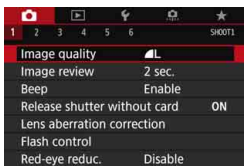

1 Display the menu screen.

- Press the <MENU> button to display the menu screen.

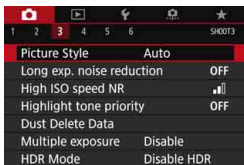

2 Select a tab.

- Each time you press the <Q> button, the main tab (group of functions) will switch.
- Press the <◀> <▶> keys to select a secondary tab.
- For example, in this manual, the [CAMERA 3] tab refers to the screen displayed when the (Shooting) tab's [3] is selected.

3 Select the desired item.

- Press the <▲> <▼> keys to select the item, then press <SET>.



4 Select the setting.

- Press the <▲> <▼> or <◀> <▶> keys to select the desired setting. (Some settings require you to press either the <▲> <▼> or <◀> <▶> keys to select those settings.)
- The current setting is indicated in blue.

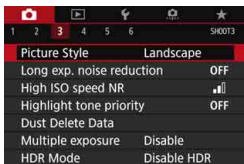

5 Set the desired setting.

- Press <SET> to set it.

6 Exit the setting.

- Press the <MENU> button to return to the shooting function settings display.

- 

• In step 2, you can also turn the <☀> dial to select a menu tab. In step 4, you can also turn the <☉> dial to select certain settings.
- In steps 2 to 5, you can also use the LCD monitor's touch screen (p.61).
- The explanation of menu functions hereafter assumes that you have pressed the <MENU> button to display the menu screen.
- To cancel the operation, press the <MENU> button.
- For details about each menu item, see page 470.

Dimmed Menu Items

Example: When Multi Shot Noise Reduction is set

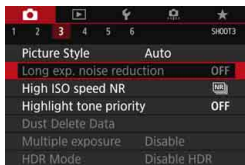

Dimmed menu items cannot be set. The menu item is dimmed if another function setting is overriding it.

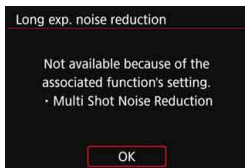

You can see the overriding function by selecting the dimmed menu item and pressing <SET>. If you cancel the overriding function's setting, the dimmed menu item will become settable.

 Some dimmed menu items will not show the overriding function.

 With [**4: Clear all camera settings**], you can reset the menu functions to the default settings (p.68).

Using the Touch Screen

The LCD monitor is a touch-sensitive panel that you can operate with your fingers.

Tap

Sample Display (Quick Control)

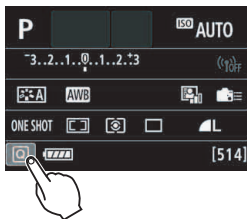

- Use your finger to tap on (touch briefly and then remove your finger from) the LCD monitor.
- By tapping, you can select menus, icons, etc., displayed on the LCD monitor.
- When touch-screen operation is possible, a frame will appear around the icon (except on menu screens). For example, when you tap on [Q], the Quick Control screen appears. By tapping on [↩], you can return to the preceding screen.



Operations possible by tapping on the screen

- Setting menu functions after pressing the <MENU> button
- Quick Control
- Setting functions after pressing the <AF>, <DRIVE>, <ISO>, <Q>, <A>, or <M> button
- Touch shutter during Live View shooting
- Setting functions during Live View shooting
- Setting functions during movie shooting
- Playback operations

Drag

Sample Display (Menu screen)

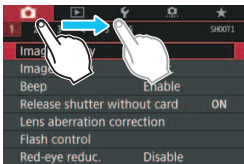

- Slide your finger while touching the LCD monitor.

Sample Display (Scale display)



Operations possible by dragging your finger on the screen

- Selecting a menu tab or item after pressing the <MENU> button
- Setting a scale control
- Quick Control
- Selecting AF points
- Setting functions during Live View shooting
- Setting functions during movie shooting
- Playback operations

MENU Silencing the Beep during Touch Operations

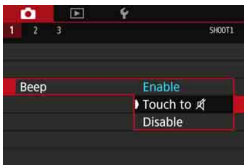

If [**1: Beep**] is set to [**Touch to** , the beep will not sound during touch operations.

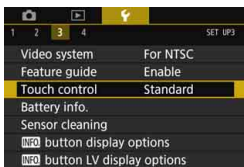
MENU Touch Control Settings**1 Select [Touch control].**

- Under the [**3**] tab, select [**Touch control**], then press <SET>.

**2 Set the touch control setting.**

- Select the desired setting, then press <SET>.
- [**Standard**] is the normal setting.
- [**Sensitive**] provides a more reactive touch response than [**Standard**]. Try using both settings and select the one you prefer.
- To disable touch-screen operations, select [**Disable**].

⚠ Cautions for Touch Screen Operations

- Since the LCD monitor is not pressure sensitive, do not use any sharp objects, such as your fingernail or a ballpoint pen, for touch operations.
- Do not use wet fingers for touch screen operations.
- If the LCD monitor has any moisture or if your fingers are wet, the touch screen may not respond or misoperation may occur. In such a case, turn off the power and wipe the LCD monitor with a cloth.
- Attaching a commercially-available protective sheet or sticker on the LCD monitor may make the touch operation response slow.
- If you quickly perform touch operation when [**Sensitive**] is set, the touch response may be slower.

Before You Start

MENU Formatting the Card

If the card is new or was previously formatted by another camera or computer, format the card with this camera.

! When the card is formatted, all images and data on the card will be erased. Even protected images will be erased, so make sure there is nothing you need to keep. If necessary, transfer the images and data to a computer, etc., before formatting the card.

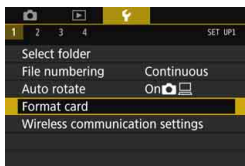

1 Select [Format card].

- Under the [1] tab, select [Format card], then press <SET>.

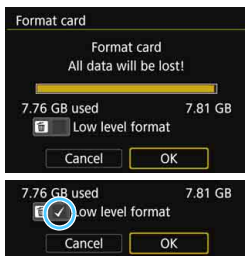

2 Format the card.

- Select [OK], then press <SET>.
- ▶ The card will be formatted.
- ▶ When the formatting is completed, the menu will reappear.
- For low-level formatting, press the <checkmark> button to add a checkmark [✓] to [Low level format], then select [OK].



Format the card in the following cases:

- The card is new.
- The card was formatted by a different camera or a computer.
- The card is full of images or data.
- A card-related error is displayed (p.496).

Low-level Formatting

- Perform low-level formatting if the card's recording or reading speed seems slow or if you want to totally erase data on the card.
- Since low-level formatting will format all recordable sectors on the card, the formatting will take slightly longer than normal formatting.
- You can stop the low-level formatting by selecting **[Cancel]**. Even in this case, normal formatting will be completed and you can use the card as usual.



- When the card is formatted or data is erased, only the file management information is changed. The actual data is not completely erased. Be aware of this when selling or discarding the card. When discarding the card, perform low-level formatting or destroy the card physically to prevent the personal data from being leaked.
- **Before using a new Eye-Fi card, the software on the card must be installed on your computer. Then format the card with the camera.**



- The card capacity displayed on the card format screen may be smaller than the capacity indicated on the card.
- This device incorporates exFAT technology licensed from Microsoft.

MENU Disabling the Beeper

You can prevent the beeper from sounding when focus is achieved, during self-timer shooting, and for touch screen operations.

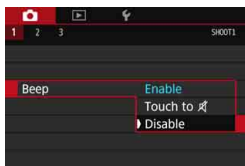

1 Select [Beep].

- Under the [**1**] tab, select [**Beep**], then press <SET>.

2 Select [Disable].

- Select [**Disable**], then press <SET>.
- The beeper will not sound.
- If [**Touch to [speaker icon]**] is selected, the beeper will be silent for touch screen operations only.

MENU Setting the Power-off Time/Auto Power Off

To save battery power, the camera turns off automatically after a set time of idle operation elapses. The default setting is 1 min., but this setting can be changed. If you do not want the camera to turn off automatically, set this to [**Disable**]. After the power turns off, you can turn on the camera again by pressing the shutter button or other buttons.

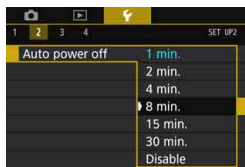

1 Select [Auto power off].

- Under the [**2**] tab, select [**Auto power off**], then press <SET>.

2 Set the desired time.

- Select the desired setting, then press <SET>.

Even if [**Disable**] is set, the LCD monitor will turn off automatically after 30 min. to save power. (The camera's power does not turn off.)

MENU Setting the Image Review Time

You can set how long the image is displayed on the LCD monitor immediately after shooting. To keep the image displayed, set **[Hold]**. To not have the image displayed, set **[Off]**.

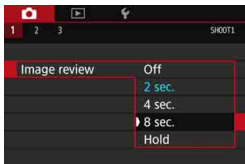

1 Select [Image review].

- Under the [**1**] tab, select **[Image review]**, then press **<SET>**.

2 Set the desired time.

- Select the desired setting, then press **<SET>**.



If **[Hold]** is set, the image will be displayed until the auto power off time elapses.

MENU Turning the LCD Monitor Off/On

The shooting function settings screen (p.55) can be set to display or turn off when you press the shutter button halfway.

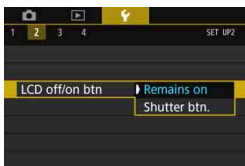

1 Select [LCD off/on btn].

- Under the [**2**] tab, select **[LCD off/on btn]**, then press **<SET>**.

2 Set the desired setting.

- Select the desired setting, then press **<SET>**.

- **[Remains on]:** Display remains on even when you press the shutter button halfway. To turn off the display, press the **<INFO.>** button.
- **[Shutter btn.]:** When you press the shutter button halfway, the display will turn off. When you let go of the shutter button, the display will turn on.

MENU Reverting the Camera to the Default Settings ☆

The camera's shooting function settings and menu settings can be reverted to their defaults.

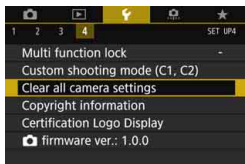

1 Select [Clear all camera settings].

- Under the [] tab, select [**Clear all camera settings**], then press <SET>.

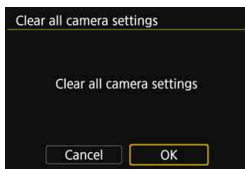

2 Select [OK].

- Select [**OK**], then press <SET>.
- Setting [**Clear all camera settings**] will reset the camera to the following default settings:

Shooting Function Settings

<SCN> mode	(Handheld Night Scene)
<Q> mode	(Miniature effect)
AF operation	One-Shot AF
AF area selection mode	Auto selection:45 pt AF
Metering mode	(Evaluative metering)
ISO speed settings	
ISO Speed Setting	Automatic setting (Auto)
Range for stills	Minimum: 100
	Maximum: 16000
Auto range	Minimum: 100
	Maximum: 6400
Minimum shutter speed for auto	Auto
Drive mode	(Single shooting)
Exposure compensation/AEB	Canceled
Flash exposure compensation	Canceled
Multiple exposure	Disable

HDR Mode	Disable HDR
Interval timer	Disable
Bulb timer	Disable
Anti-flicker shooting	Disable
Mirror lockup	Disable
Viewfinder display	
Electronic level	Hide
Grid display	Hide
Flicker detection	Show
Custom Functions	Unchanged
Flash control	
Flash firing	Enable
E-TTL II flash metering	Evaluative flash metering
Flash sync. speed in Av mode	Auto

Image Recording Settings

Image quality	L
Aspect ratio	3:2
Picture Style	Auto
Auto Lighting Optimizer	Standard
Lens aberration correction	
Peripheral illumination correction	Enable / Correction data retained
Chromatic aberration correction	Enable / Correction data retained
Distortion correction	Disable / Correction data retained
White balance	Auto (Ambience priority)
Custom White Balance	Canceled
White balance correction	Canceled
White balance bracketing	Canceled
Color space	sRGB
Long exposure noise reduction	Disable
High ISO speed noise reduction	Standard
Highlight tone priority	Disable
File numbering	Continuous
Auto cleaning	Enable
Dust Delete Data	Erased

Camera Settings

Auto power off	1 min.
Beep	Enable
Release shutter without card	Enable
Image review	2 sec.
Highlight alert	Disable
AF point display	Disable
Playback grid	Off
Histogram display	Brightness
Control over HDMI	Disable
Image jump w/	(10 images)
Auto rotate	On
LCD brightness	
LCD off/on button	Remains on
Touch control	Standard
Date/Time/Zone	Unchanged
Language	Unchanged
Video system	Unchanged
Feature guide	Enable
INFO button display options	All items selected
Multi function lock	(Quick Control Dial) only
Custom shooting mode	Unchanged
Copyright information	Unchanged
Eye-Fi transmission	Disable
Configure: MY MENU	Unchanged
Menu display	Normal display
Wireless communication settings	
Wi-Fi/NFC	Disable



- For how to clear all the Custom Function settings, see page 410.
- Refer to the Wireless Function Instruction Manual for wireless function settings.

Live View Shooting Settings

Live View shooting	Enable
AF method	☺+Tracking
AF operation	ONE SHOT
Touch shutter	Disable
Grid display	Hide
Exposure simulation	Enable
Silent LV shooting	Mode 1
Metering timer	8 sec.
Creative filters	Disable

Movie Shooting Settings

<👁> mode	☺ (Dream)
ISO speed settings	
Range for movies	Minimum: 100 Maximum: 12800
Movie Servo AF	Enable
AF method	☺+Tracking
Movie recording quality	
MOV/MP4	MP4
Movie recording size	NTSC: ☺FHD 29.97P (Standard) PAL: ☺FHD 25.00P (Standard)
Digital zoom	Disable
Sound recording	Auto
Wind filter	Auto
Attenuator	Disable
Movie Servo AF speed	
When active	Always on
AF speed	0 (Standard)
Movie Servo AF tracking sensitivity	0
Metering timer	8 sec.
Grid display	Hide
👁 button function	☺AF/-
Video snapshot	Disable
Time-lapse movie	Disable
Remote control shooting	Disable
Creative filters	Disable

Displaying the Grid

You can display a grid in the viewfinder to help you check the camera tilt or compose the shot.

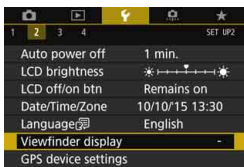

- 1 **Select [Viewfinder display].**
 - Under the [**2**] tab, select **[Viewfinder display]**, then press **<SET>**.



- 2 **Select [Grid display].**



- 3 **Select [Show].**
 - ▶ When you exit the menu, the grid will appear in the viewfinder.

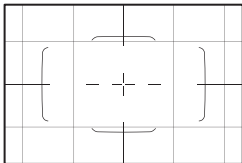

You can display a grid on the LCD monitor during Live View shooting and before you start shooting a movie (p.270, 331).

Displaying the Electronic Level

You can display the electronic level on the LCD monitor and in the viewfinder to help you correct the camera tilt. Note that you can check only the horizontal tilt and not the forward/backward tilt.

Displaying the Electronic Level on the LCD Monitor

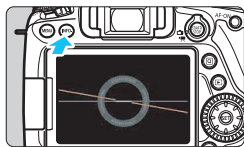

1 Press the <INFO.> button.

- Each time you press the <INFO.> button, the screen display will change.
- Display the electronic level.
- If the electronic level does not appear, set [**3**: **INFO** button display options] so that the electronic level can be displayed (p.450).



2 Check the camera's tilt.

- The horizontal tilt is displayed in 1° increments. The tilt scale is marked in 5° increments.
- When the red line turns green, it indicates that the tilt is almost corrected.

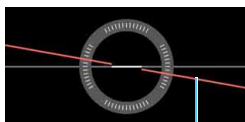

Horizontal level

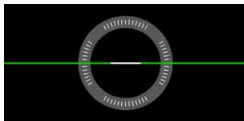

- Even when the tilt is corrected, there may be a margin of error of approx. $\pm 1^\circ$.
- If the camera is very tilted, the electronic level's margin of error will be larger.

 During Live View shooting and before movie shooting (except with **+**Tracking), you can also display the electronic level as described above (p.259, 301).

MENU Displaying the Electronic Level in the Viewfinder

A simple electronic level using a camera icon can be displayed in the viewfinder. Since this indicator is displayed during shooting, you can take the picture while checking the camera tilt.

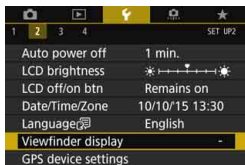

1 Select [Viewfinder display].

- Under the [**2**] tab, select [Viewfinder display], then press <SET>.

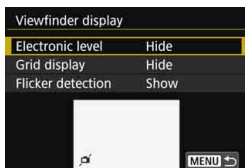

2 Select [Electronic level].



3 Select [Show].

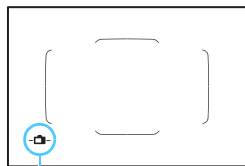

Electronic level

4 Press the shutter button halfway.

- The electronic level will appear as shown in the illustration.



- This level also works with vertical shooting.

Even when the tilt is corrected, there may be a margin of error of approx. $\pm 1^\circ$.

Displaying the Flicker Detection ☆

If you set this function, < **Flicker!** > will appear in the viewfinder when the camera detects flicker caused by the blinking of the light source. By default, flicker detection is set to **[Show]**.

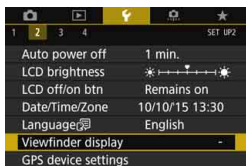

1 Select **[Viewfinder display]**.

- Under the [**2**] tab, select **[Viewfinder display]**, then press < **(SET)** >.

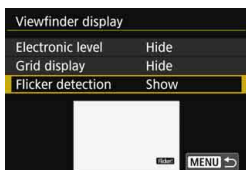

2 Select **[Flicker detection]**.



3 Select **[Show]**.

 If you set [**4: Anti-flicker shoot.**] to **[Enable]**, you can shoot with reduced unevenness of exposure caused by the flicker (p.179).

Feature Guide and Help

The Feature guide and Help display information about camera features.

Feature Guide

The Feature guide appears when you change the shooting mode or set a shooting function, Live View shooting, movie shooting, or Quick Control for playback, and displays a brief description of that mode, function or option. It also displays a description when you select a function or option with Quick Control. The Feature guide turns off when you tap on the description or proceed with the operation.

● Shooting mode (Sample)

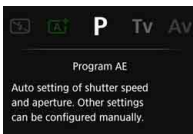
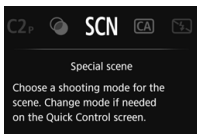

● Quick Control (Sample)

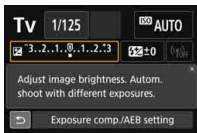

Shooting settings



Live View shooting



Playback

MENU Disabling the Feature Guide



Select [Feature guide].

- Under the [**3**] tab, select [**Feature guide**], then press <SET>.
- Select [**Disable**], then press <SET>.

Help

When [**INFO Help**] is displayed at the bottom of the menu screen, pressing the <INFO.> button displays the function's description (Help). If the Help fills more than one screen, a scroll bar will appear on the right edge. You can turn the <☉> dial or press the <▲> <▼> keys to scroll.

● Example: [**📷3: Long exp. noise reduction**]

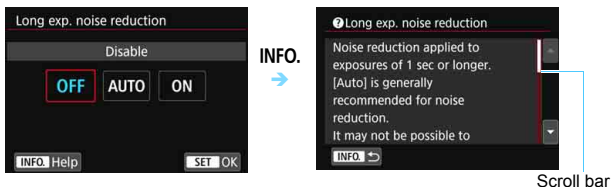

● Example: [**📷C.Fn I-1: Exposure level increments**]

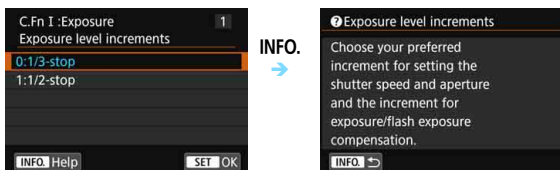

● Example: [**📷C.Fn II-1: Tracking sensitivity**]



2

Basic Shooting

This chapter explains how to use the Basic Zone modes on the Mode Dial for best results.

With Basic Zone modes, all you do is point and shoot, and the camera sets everything automatically (p.107, 460). Also, to prevent botched pictures due to misoperations, advanced shooting function settings cannot be changed.

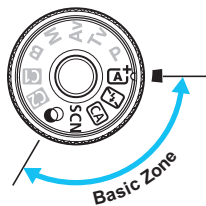

Before Shooting in the <SCN> or <Creative filters> Mode

When the LCD monitor is turned off, press the <Q> button or <INFO.> button (p.88, 101, 450) to check which shooting mode is set before shooting.

- * <SCN>: Special scene
- * <Creative filters>: Creative filters

[A⁺] Fully Automatic Shooting (Scene Intelligent Auto)

<[A⁺]> is a fully automatic mode. The camera analyzes the scene and sets the optimum settings automatically. It also adjusts focus automatically by detecting whether the subject is still or moving (p.81).



1 Set the Mode Dial to <[A⁺]>.

- Turn the Mode Dial while holding down the lock release button at the center.

Area AF frame

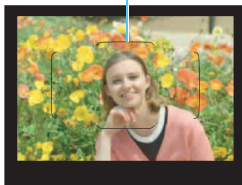

2 Aim the Area AF frame over the subject.

- All the AF points will be used to focus, and the camera will focus on the closest object.
- Aiming the center of the Area AF frame over the subject will make focusing easier.

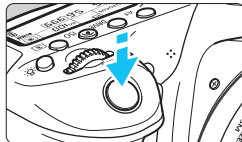

3 Focus on the subject.

- Press the shutter button halfway. The lens focusing ring will rotate to focus.
- ▶ When achieving focus, the AF point that has achieved focus will be displayed. At the same time, the beeper will sound and the focus indicator **<●>** in the viewfinder will light up.
- ▶ In low light, the AF point(s) will light up briefly in red.
- ▶ If necessary, the built-in flash will be raised automatically.



Focus indicator

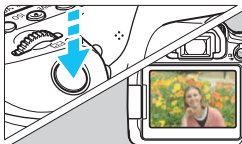

4 Take the picture.

- Press the shutter button completely to take the picture.
- ▶ The captured image will be displayed for approx. 2 sec. on the LCD monitor.
- After you finish shooting, push down the built-in flash with your fingers.



The **A⁺** mode makes the colors look more impressive in nature, outdoor, and sunset scenes. If you do not obtain the desired color tones, change the mode to a Creative Zone mode and select a Picture Style other than **A⁺**, then shoot again (p.154).

? FAQ

- **The focus indicator <●> blinks and focus is not achieved.**
Aim the Area AF frame over an area with good contrast, then press the shutter button halfway (p.50). If you are too close to the subject, move away and try again.
- **When focus is achieved, the AF points do not light up in red.**
The AF points light up in red only when focus is achieved in low-light conditions.
- **Multiple AF points light up simultaneously.**
Focus has been achieved at all those points. You can take the picture as long as an AF point covering the target subject is lighting up.

- **The beeper continues to beep softly. (The focus indicator <●> does not light up.)**



It indicates that the camera is focusing continuously on a moving subject. (The focus indicator <●> does not light up.) You can take sharp pictures of a moving subject.

Note that the focus lock (p.81) will not work in this case.

- **Pressing the shutter button halfway does not focus on the subject.**

If the focus mode switch on the lens is set to <MF> (manual focus), set it to <AF> (autofocus).

- **The flash fired even though it was daylight.**

For a backlit subject, the flash may fire to help lighten the subject's dark areas. If you do not want the flash to fire, use the Quick Control to set [**Built-in flash firing**] to [] (p.106) or set the < > (Flash Off) mode and shoot (p.83).

- **The built-in flash fired and the picture came out extremely bright.**

Move further away from the subject and shoot. When shooting with flash, if the subject is too close to the camera, the picture may come out extremely bright (overexposure).

- **In low light, the built-in flash fired a series of flashes.**

Pressing the shutter button halfway may trigger the built-in flash to fire a series of flashes to assist autofocusing. This is called the AF-assist beam. Its effective range is approx. 4 meters / 13.1 feet. The built-in flash will make a sound when firing continuously. This is normal and not a malfunction.

- **When flash was used, the bottom part of the picture came out unnaturally dark.**

The shadow of the lens barrel was captured in the picture because the subject was too close to the camera. Move further away from the subject and shoot. If a hood is attached to the lens, remove it before taking the flash picture.

Full Auto Techniques (Scene Intelligent Auto) ■

Recomposing the Shot



Depending on the scene, position the subject toward the left or right to create a balanced background and good perspective.

In the $\langle \text{AF}^+ \rangle$ mode, pressing the shutter button halfway to focus on a still subject will lock the focus on that subject. Recompose the shot while keeping the shutter button pressed halfway, and then press the shutter button completely to take the picture. This is called “focus lock”. Focus lock is also possible in other Basic Zone modes (except $\langle \text{AF} \rangle$ & $\langle \text{AF} \text{ ON} \rangle$).

Shooting a Moving Subject



In the $\langle \text{AF}^+ \rangle$ mode, if the subject moves (distance to camera changes) during or after focusing, AI Servo AF will take effect to focus on the subject continuously. (The beeper will continue beeping softly.) As long as you keep the Area AF frame positioned over the subject while pressing the shutter button halfway, the focusing will be continuous. When you want to take the picture, press the shutter button completely.

Live View Shooting

You can shoot while viewing the image on the LCD monitor. This is called "Live View shooting". For details, see page 255.

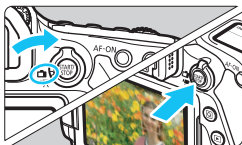

1 Set the Live View shooting/Movie shooting switch to .

2 Display the Live View image on the LCD monitor.

- Press the <START/STOP> button.
- ▶ The Live View image will appear on the LCD monitor.



3 Focus on the subject.

- Press the shutter button halfway to focus.
- ▶ When focus is achieved, the AF point will turn green and the beeper will sound.

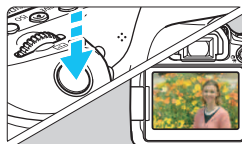

4 Take the picture.

- Press the shutter button completely.
- ▶ The picture is taken and the captured image is displayed on the LCD monitor.
- ▶ When the playback display ends, the camera will return to Live View shooting automatically.
- Press the <START/STOP> button to exit the Live View shooting.

You can also rotate the LCD monitor for different angles (p.40).



Normal angle



Low angle



High angle

Disabling Flash

The camera analyzes the scene and sets the optimum settings automatically. In places where flash photography is prohibited such as in a museum or an aquarium, use the < > (Flash Off) mode.

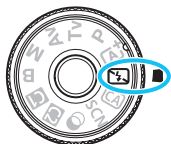

Shooting Tips

- **Prevent camera shake if the numeric display (shutter speed) in the viewfinder blinks.**

Under low light when camera shake is prone to occur, the viewfinder's shutter speed display will blink. Hold the camera steady or use a tripod. When using a zoom lens, use a wide angle to reduce blur caused by camera shake even with handheld shooting.

- **Take portraits without flash.**

In low-light conditions, tell the subject to keep still until the picture is taken. Any movement by the subject during shooting may result in the subject being blurred in the picture.

CA Creative Auto Shooting

In the <CA> mode, you can set the following functions for shooting: (1) Ambience-based shots, (2) Background blur, (3) Drive mode, and (4) Built-in flash firing. The default settings are the same as the <A+> mode.

* CA stands for Creative Auto.



1 Set the Mode Dial to <CA>.



2 Press the <Q> button (10).
▶ The Quick Control screen will appear.

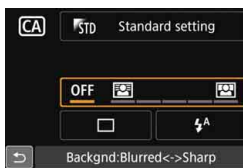

3 Set the desired function.

- Press the <▲> <▼> or <◀> <▶> keys to select a function.
- ▶ The settings of the selected function and Feature guide (p.75) will appear.
- For the setting procedure and details on each function, see pages 85-87.

4 Take the picture.

- Press the shutter button completely to take the picture.

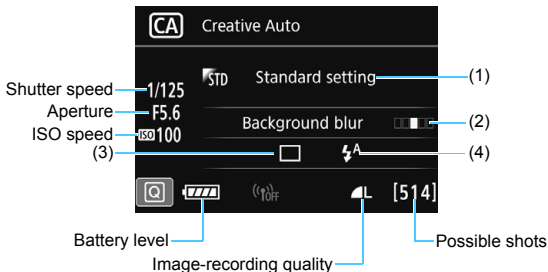

If you set (1) or (2) when the camera is set for Live View shooting, you can see the effect on the screen before you start shooting.

(1) Ambience-based shots



You can select and shoot with the ambience you want to convey in your images. Turn the <☀> or <☾> dial to select the ambience. You can also select it from a list by pressing <SET>. For details, see page 108.

(2) Background blur



- If **[OFF]** is set, the degree of background blur will change depending on the brightness.
- If it is set to any setting other than **[OFF]**, you can adjust the background blur regardless of the brightness.
- If you turn the < > or < > dial to move the cursor to the right, the background will look sharper.
- Turning the < > or < > dial to move the cursor to the left will blur the subject's background. Note that depending on the lens's maximum aperture (smallest f/number), certain slider adjustments may not be selectable (indicated by •).
- If you use Live View shooting, you can see how the image is blurred in front of and behind the point of focus. When you turn the < > or < > dial, **[Simulating blur]** will be displayed on the LCD monitor.
- If you want to blur the background, see “Shooting Portraits” on page 95.
- Depending on the lens and shooting conditions, the background may not look so blurred.
- This function cannot be set if you use flash. If < > has been set and you set background blur, < > will be set automatically.

If **[Simulating blur]** is enabled during Live View shooting, the image displayed with < **Exp.SIM** > (p.258) blinking may have more noise than the actual image being recorded, or it may look dark.

(3) Drive mode: Use the  or  dial to make the selection. You can also select it from a list by pressing .

 **Single shooting:**

Shoot one image at a time.

 **High-speed continuous shooting:**

While you hold down the shutter button completely, shots will be taken continuously. You can shoot up to approx. 7.0 shots per second.

 **Low-speed continuous shooting:**

While you hold down the shutter button completely, shots will be taken continuously. You can shoot up to approx. 3.0 shots per second.

 **Silent single shooting:**

You can shoot one image at a time while suppressing the camera noise during viewfinder shooting.



 **Silent continuous shooting:**

You can shoot up to approx. 3.0 shots per second continuously while suppressing the camera noise during viewfinder shooting.

 **Self-timer: 10 sec./remote control:**

 **Self-timer: 2 sec./remote control:**

The picture is taken 10 seconds or 2 seconds after you press the shutter button. A remote controller can also be used.



(4) Built-in flash firing: Turn the  or  dial to select the desired setting. You can also select it from a list by pressing .

 **Auto built-in flash:** The flash fires automatically when necessary.

 **Built-in flash on** : The flash fires at all times.

 **Built-in flash off** : The flash is disabled.



- When using the self-timer, see the  notes on page 140.
- When using , see “Disabling Flash” on page 83.

SCN: Special Scene Mode

The camera will automatically choose the appropriate settings when you select a shooting mode for your subject or scene.



1 Set the Mode Dial to <SCN>.



2 Press the <Q> button (10).
▶ The Quick Control screen will appear.

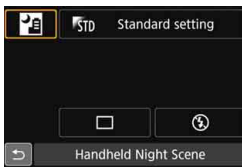

3 Select a shooting mode.

- Press the <▲> <▼> or <◀> <▶> keys to select the desired shooting mode's icon.
- Turn the <☀> or <☾> dial to select a shooting mode.
- You can also select the shooting mode icon and press <SET> to display a selection of shooting modes from which you can select one.

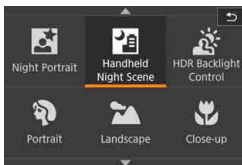

Available Shooting Modes in the <SCN> Mode

Shooting Mode	Page
Food	p.89
Kids	p.90
Candlelight	p.91
Night Portrait	p.92
Handheld Night Scene	p.93

Shooting Mode	Page
HDR Backlight Control	p.94
Portrait	p.95
Landscape	p.96
Close-up	p.97
Sports	p.98

🍴 Shooting Food

When shooting food, use <🍴> (Food). The photo will look bright and appetizing. Also, depending on the light source, the reddish tinge will be suppressed in the pictures taken under tungsten lights, etc.

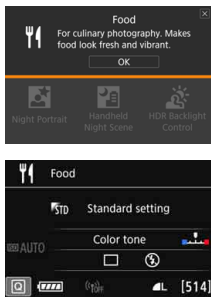

💡 Shooting Tips

- **Change the color tone.**
You can change [**Color tone**]. To increase the food's reddish tinge, set it toward [**Warm**]. Set it toward [**Cool**] if it looks too red.
 - **Avoid using flash.**
If you use flash, the light may reflect off the dish or food and results in unnatural shadows. By default, <🚫> (Built-in flash off) is set. Try to prevent camera shake when shooting in low-light conditions.
- Since this mode lets you shoot the food in appetizing color tones, human subjects may be shot in an unsuitable skin tone.
 - The warm color cast of subjects may fade.
 - When multiple light sources are included on the screen, the warm color cast of the picture may not be lessened.
 - If you use flash, the [**Color tone**] setting will switch to the standard.

Shooting Children

When you want to continuously focus on and shoot children running around, use  (Kids). Skin tones will look healthy.

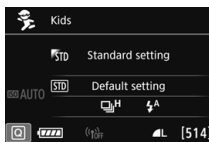
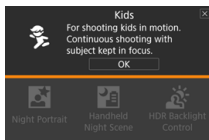

Shooting Tips

- **Track the subject with the Area AF frame.**

Press the shutter button halfway to start autofocusing in Area AF frame. During autofocusing, the beeper will continue beeping softly. If focus cannot be achieved, the focus indicator  will blink.

- **Shoot continuously.**

The default setting is  (High-speed continuous shooting*). When you want to take the picture, press the shutter button completely. If you hold down the shutter button, you can shoot continuously while maintaining autofocusing to capture changes in the subject's facial expression and movement.

* Viewfinder shooting: max. approx. 7.0 shots/sec., Live View shooting: max. approx. 5.0 shots/sec.

- While the flash is recycling, “**buSY**” is displayed in the viewfinder and on the LCD panel, and a picture cannot be taken. Take the picture after this display turns off. During Live View shooting, “**BUSY**” is displayed on the LCD monitor, and you cannot view the subject.
- See the cautions on page 99.

Shooting Candlelight Portraits

When shooting a human subject in candlelight, use <> (Candlelight). The candlelight color tones will be retained in the photo.

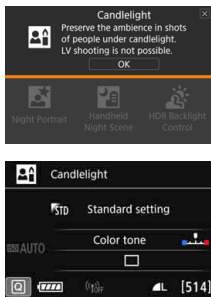

Shooting Tips

- **Use the center AF point to focus.**
Aim the center AF point in the viewfinder over the subject, then shoot.
 - **Prevent camera shake if the numeric display (shutter speed) in the viewfinder blinks.**
Under low light when camera shake is prone to occur, the viewfinder's shutter speed display will blink. Hold the camera steady or use a tripod. When using a zoom lens, use the wide-angle end to reduce blur caused by camera shake even while handholding the camera.
 - **Change the color tone.**
You can change [Color tone]. To increase the candlelight's reddish tint, set it toward [Warm]. Set it toward [Cool] if it looks too red.
- **Live View shooting cannot be used.**
 - The built-in flash will not fire. In low light, the AF-assist beam may be emitted (p.119).
 - If you are using an external Speedlite, the Speedlite will fire.

Shooting Night Portraits (With a Tripod)

To shoot people at night and obtain a natural-looking night scene in the background, use the  (Night Portrait) mode. Using a tripod is recommended.

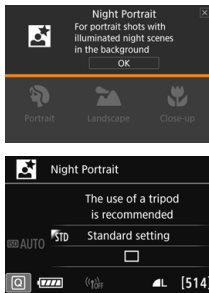

Shooting Tips

- **Use a wide-angle lens and a tripod.**



When using a zoom lens, use the wide-angle end to obtain a wide night view. Also, use a tripod to prevent camera shake.

- **Check the subject's brightness.**

Under low light, the built-in flash will fire automatically to obtain a good exposure of the subject.

It is recommended to play back the image after shooting to check the image brightness. If the subject looks dark, move nearer and shoot again.

- **Also shoot in other shooting modes.**

Since camera shake is prone to occur with night shots, shooting also with  and  is recommended.

-  ● Tell the subject to keep still even after the flash fires.
- If you use the self-timer together with flash, the self-timer lamp will light up briefly after the picture is taken.
- See the cautions on page 99.

Shooting Night Scenes (Handheld)

Using a tripod when shooting a night scene gives the best results. However, the  (Handheld Night Scene) mode enables you to shoot night scenes even while handholding the camera. In this shooting mode, four shots are taken continuously for each picture, and the resulting one image with reduced camera shake is recorded.

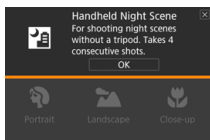



Shooting Tips

- **Hold the camera firmly.**

While shooting, hold the camera firmly and steadily. In this mode, four shots are aligned and merged into a single image. However, if there is significant misalignment in any of the four shots due to camera shake, they may not align properly in the final image.

- **For shots of people, turn on the flash.**

If you want to include people in the night scene shot, press the  button to set  (Built-in flash on). To take a nice portrait, the first shot will use flash. Tell the subject not to move until all four continuous shots are taken.



- Compared to other shooting modes, the shooting range will be smaller.
- See the cautions on page 99.

Shooting Backlit Scenes

When shooting a scene having both bright and dark areas, use the  (HDR Backlight Control) mode. When you take one picture in this mode, three continuous shots are taken at different exposures. This results in one image, with a wide tonal range, that has minimized the clipped shadows caused by backlighting.

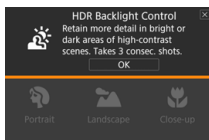

Shooting Tips

● Hold the camera firmly.

While shooting, hold the camera firmly and steadily. In this mode, three shots are aligned and merged into a single image. However, if there is significant misalignment in any of the three shots due to camera shake, they may not align properly in the final image.

- Compared to other shooting modes, the shooting range will be smaller.
- Flash shooting is not possible. In low light, the AF-assist beam may be emitted (p.119).
- See the cautions on page 99.

 HDR stands for High Dynamic Range.

Shooting Portraits

The (Portrait) mode blurs the background to make the human subject stand out. It also makes skin tones and hair look softer.

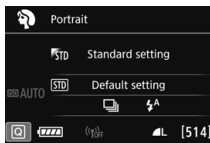
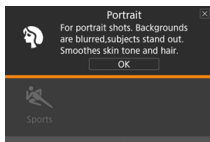

Shooting Tips

- **Select the location where the distance between the subject and the background is the farthest.**

The further the distance between the subject and background, the more blurred the background will look. The subject will also stand out better against an uncluttered dark background.

- **Use a telephoto lens.**

If you have a zoom lens, use the telephoto end to fill the frame with the subject from the waist up. Move in closer if necessary.

- **Focus on the face.**

Check that the AF point covering the face lights up. For close-ups of the face, focus on the eyes.



The default setting is (Low-speed continuous shooting). If you hold down the shutter button, you can shoot continuously (max. approx. 3.0 shots/sec.) to capture changes in the subject's facial expression and pose.

Shooting Landscapes

Use the < > (Landscape) mode for wide scenery or to have everything in focus from near to far. For vivid blues and greens, and very sharp and crisp images.

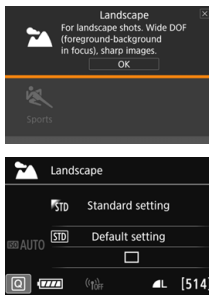

Shooting Tips

- **With a zoom lens, use the wide-angle end.**
When using the wide-angle end of a zoom lens, objects near and far will be in focus better than at the telephoto end. It also adds breadth to landscapes.
- **Shooting night scenes.**
The < > mode is also good for night scenes because it disables the built-in flash. When shooting night scenes, use a tripod to prevent camera shake.



- The built-in flash will not fire even in backlit or low-light conditions.
- If you are using an external Speedlite, the Speedlite will fire.

Shooting Close-ups

When you want to shoot flowers or small things up close, use the  (Close-up) mode. To make small things appear much larger, use a macro lens (sold separately).

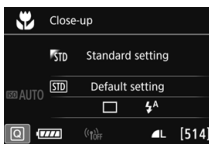
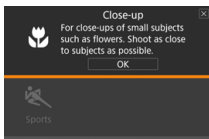



Shooting Tips

- **Use a simple background.**

A simple background makes small objects such as flowers stand out better.

- **Move in as close as possible to the subject.**

Check the lens for its minimum focusing distance. Some lenses have indications such as **<MACRO 0.39m/1.3ft>** on them. The lens minimum focusing distance is measured from the  (focal plane) mark on the top of the camera to the subject. If you are too close to the subject, the focus indicator  will blink.

If you use the built-in flash and the bottom part of the picture comes out unnaturally dark, move away from the subject and try again.

- **With a zoom lens, use the telephoto end.**

If you have a zoom lens, using the telephoto end will make the subject look larger.

Shooting Moving Subjects

Use the  (Sports) mode to shoot a moving subject, such as a running person or a moving vehicle.

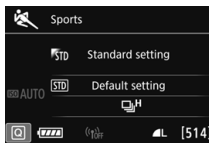
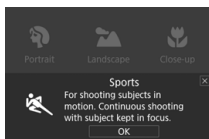



Shooting Tips

● Use a telephoto lens.

The use of a telephoto lens is recommended for shooting from a distance.

● Track the subject with the Area AF frame.

Press the shutter button halfway to start autofocusing in Area AF frame. During autofocusing, the beeper will continue beeping softly. If focus cannot be achieved, the focus indicator  will blink. The default setting is  (High-speed continuous shooting*). When you want to take the picture, press the shutter button completely. If you hold down the shutter button, you can shoot continuously while maintaining autofocusing to capture changes in the subject's movement.

* Viewfinder shooting: max. approx. 7.0 shots/sec., Live View shooting: max. approx. 5.0 shots/sec.

- The built-in flash will not fire even in backlit or low-light conditions.
- Under low light when camera shake tends to occur, the viewfinder's shutter speed display on the bottom left will blink. Hold the camera steady and shoot.
- If you are using an external Speedlite, the Speedlite will fire.
- During Live View shooting, the image quality can be set to **RAW** or JPEG. If **M RAW** or **S RAW** is set, the image will be recorded in **RAW** quality.



Cautions for Kids

- During Live View shooting, the image quality can be set to **RAW** or JPEG. If **M RAW** or **S RAW** is set, the image will be recorded in **RAW** quality.
- During Live View shooting, if flash is fired in continuous shooting, the continuous shooting speed will decrease. Even if the flash is not fired for subsequent shots, shooting will be performed with the decreased continuous shooting speed.

Cautions for Night Portrait and Handheld Night Scene

- During Live View shooting, it may be difficult to focus on dots of light such as in a night scene. In such a case, set the lens's focus mode switch to **<MF>** and focus manually.
- The Live View image displayed will not look exactly the same as the actual image shot.

Cautions for Handheld Night Scene and HDR Backlight Control

- You cannot select RAW or RAW+JPEG. If RAW is set, the image will be recorded in the **L** quality. Also, if RAW+JPEG is set, the image will be recorded in the set JPEG quality.
- If you shoot a moving subject, the subject's movement may leave afterimages, or the surrounding area of the subject may become dark.
- The image alignment may not function properly with repetitive patterns (lattice, stripes, etc.), flat or single-tone images, or images significantly misaligned due to camera shake.
- It takes some time to record images to the card since they are merged after shooting. During the processing of the images, "**buSY**" will be displayed in the viewfinder and on the LCD panel, and you cannot take another picture until the processing is completed.

Cautions for Night Portrait

- During Live View shooting, it may be difficult to focus when the face of the subject looks dark. In such a case, set the lens's focus mode switch to **<MF>** and focus manually.

Cautions for Handheld Night Scene

- When shooting with flash, if the subject is too close to the camera, the picture may come out extremely bright (overexposure).
- If you use flash to shoot a night scene with few lights, the shots may not align correctly. This can result in a blurry picture.
- If you use flash and the human subject is close to the background that is also illuminated by the flash, the shots may not align correctly. This can result in a blurry picture. Unnatural shadows and unsuitable colors may also appear.
- External flash coverage:
 - When using a Speedlite with automatic flash coverage setting, the zoom position will be fixed to the wide end, regardless of the lens's zoom position.
 - When using a Speedlite requiring manual flash coverage setting, set the flash head to the wide (normal) position.

Cautions for HDR Backlight Control

- Note that the image may not be rendered with a smooth gradation and may look irregular or have significant noise.
- HDR Backlight Control may not be effective for excessively backlit scenes or extremely high-contrast scenes.
- When shooting subjects that are sufficiently bright, for example for normally lit scenes, the image may look unnatural because of the applied HDR effect.

Applying Creative Filters

In the  (Creative filter) mode, you can apply one of ten filter effects (Grainy B/W*, Soft focus*, Fish-eye effect*, Toy camera effect*, Miniature effect*, Water painting effect*, HDR art standard, HDR art vivid, HDR art bold, and HDR art embossed) for shooting. When the camera is set for Live View shooting, you can see the effect on the screen before you start shooting. The camera saves only the image with the Creative filter applied.

For the effects marked with an asterisk, you can also take a picture without a Creative filter, then apply the effect afterward and save it as a new image (p.399).



1 Set the Mode Dial to .

2 Set the Live View shooting/Movie shooting switch to .







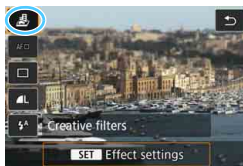

3 Display the Live View image.

- Press the  button to display the Live View image.



4 Select [Creative filters] with Quick Control.

- Press the  button (.
- Press the  >  keys to select  on the upper left of the screen, then press the .

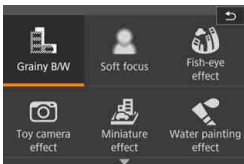

5 Select a shooting mode.

- Press the <▲> <▼> or <◀> <▶> keys to select a shooting mode, then press <SET> and select [OK].
- ▶ The image will be displayed with the effects of the filter applied.
- For the Miniature effect, press the <▲> <▼> keys to move the white frame to where you want the image to look sharp.

Available Shooting Modes in the Mode

Shooting Mode	Page
Grainy B/W	p.103
Soft focus	p.103
Fish-eye effect	p.104
Toy camera effect	p.104
Miniature effect	p.104

Shooting Mode	Page
Water painting effect	p.104
HDR art standard	p.104
HDR art vivid	p.105
HDR art bold	p.105
HDR art embossed	p.105

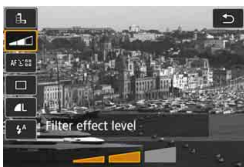

6 Adjust the effect.

- Press the <[Q]> button and select the icon below [Creative filters] (except for , , , and).
- Press the <◀> <▶> keys to adjust the filter effect, then press <SET>.

7 Take the picture.

- Press the shutter button completely to take the picture.
- To return to viewfinder shooting, press the <START/STOP> button to exit Live View shooting. Then press the shutter button completely to take the picture.

If you do not want the Live View image to be displayed when setting functions, press the <[Q]> button after step 1 and set [Creative filters].



- You cannot select RAW or RAW+JPEG. If RAW is set, the image will be recorded in the **L** quality. Also, if RAW+JPEG is set, the image will be recorded in the set JPEG quality.
- When , , , , , or is set, continuous shooting cannot be set.
- Dust Delete Data (p.405) will not be appended to images shot with Fish-eye effect applied.
- is set to (Flash Off) by default. Try to prevent camera shake when shooting in low-light conditions.



During Live View Shooting

- With Grainy B/W, the grainy effect displayed on the LCD monitor will look different from the grainy effect recorded in the picture.
- With the Soft focus and Miniature effects, the blurred effect displayed on the LCD monitor may look different from the blurred effect recorded in the picture.
- The histogram is not displayed.
- Magnified view is not possible.
- In Creative Zone modes, you can set some Creative filters with Quick Control (p.266).

Creative Filter Characteristics

Grainy B/W

Creates a grainy black-and-white photo. You can change the black-and-white effect by adjusting the contrast.

Soft focus

Gives the image a soft look. You can change the degree of softness by adjusting the blur.

-  **Fish-eye effect**

Gives the effect of a fish-eye lens. The image will have a barrel-type distortion.

Depending on the level of this filter effect, the area trimmed along the periphery of the image changes. Also, since this filter expands the center part of the image, the resolution at the center may decrease depending on the number of recorded pixels. Check the image on the screen when setting this filter. The AF point will be fixed at center.

-  **Toy camera effect**

Darkens the photo's corners and applies a color tone that makes it look as if it was shot by a toy camera. You can change the color cast by adjusting the color tone.

-  **Miniature effect**

Creates a diorama effect.

During Live View shooting, you can change where the image looks sharp. In step 5, if you press the $\langle \text{Q} \rangle$ button (or tap $[\text{Q}]$ on the bottom right of the screen), you can switch between the white frame's vertical and horizontal orientations. The camera focuses on the center of the white frame.

During viewfinder shooting, aim the center AF point over the subject and shoot.

-  **Water painting effect**



Makes the photo look like a watercolor painting with soft colors. You can control the color density by adjusting the filter effect. Note that night scenes or dark scenes may not be rendered with a smooth gradation and may look irregular or have significant noise.

-  **HDR art standard**

Clipped highlights and shadows will be reduced. The contrast will be lower, and the gradation flatter to have the picture look like a painting. The subject outlines will have bright (or dark) edges.

 For $\langle \text{HDR} \rangle$ $\langle \text{HDR} \rangle$ $\langle \text{HDR} \rangle$ $\langle \text{HDR} \rangle$, clipped highlights and shadows will be reduced for a high dynamic range of tones even with high-contrast scenes.

Three images of different exposures are captured continuously for each shot and merged into a single image. See the cautions on page 105.

-  **HDR art vivid**
The colors are more saturated than with [**HDR art standard**], and the low contrast and flat gradation create a graphic art effect.
-  **HDR art bold**
The colors are the most saturated, making the subject pop out, and the picture look like an oil painting.
-  **HDR art embossed**
The color saturation, brightness, contrast and gradation are decreased to make the picture look flat. The picture looks faded and old. The subject outlines will have bolder bright (or dark) edges.



Cautions for HDR Art Standard, HDR Art Vivid, HDR Art Bold, and HDR Art Embossed

- Compared to other shooting modes, the shooting range will be smaller.
- The Live View image displayed with the filter applied will not look exactly the same as the actual image.
- If you shoot a moving subject, the subject's movement may leave afterimages, or the surrounding area of the subject may become dark.
- The image alignment may not function properly with repetitive patterns (lattice, stripes, etc.), flat or single-tone images, or images significantly misaligned due to camera shake.
- If you are handholding the camera, try to prevent camera shake when shooting.
- The color gradation of the sky or white walls may not be reproduced correctly. Irregular exposure, irregular colors, or noise may appear.
- Shooting under fluorescent or LED lighting may result in unnatural color reproduction of the illuminated areas.
- It takes some time to record images to the card since they are merged after shooting. During the processing of the images, "buSY" will be displayed in the viewfinder and on the LCD panel, and you cannot take another picture until the processing is completed.
- Flash shooting is not possible. In low light, the AF-assist beam may be emitted (p.119).

Q Quick Control

In Basic Zone modes, when the shooting function settings are displayed, you can press the **<Q>** button to display the Quick Control screen. The tables on the next page show the functions that can be set with the Quick Control screen in each Basic Zone mode.

Example: Portrait mode

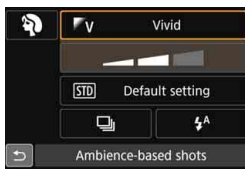
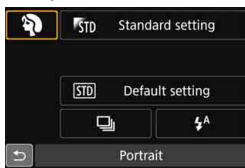

1 Set the Mode Dial to a Basic Zone mode.

2 Press the **<Q>** button (10).

- ▶ The Quick Control screen will appear.

3 Set the desired function.

- Press the **<▲>** **<▼>** or **<◀>** **<▶>** keys to select a function.
- ▶ The settings of the selected function and Feature guide (p.75) will appear.
- Turn the **<☀>** or **<☀>** dial to change the setting.
- You can also select from a list by selecting a function and pressing **<SET>**.

Settable Functions in Basic Zone Modes

●: Default setting^{*1} ○: User selectable □: Not selectable

Function				CA	SCN				
Drive mode (p.138)	: Single shooting	●	●	●	●	○	●	●	●
	H: High-speed continuous shooting	○	○	○	○	●	○	○	○
	L: Low-speed continuous shooting	○	○	○	○	○	○	○	○
	S: Silent single shooting ^{*2}	○	○	○	○	○	○	○	○
	S: Silent continuous shooting ^{*2}	○	○	○	○	○	○	○	○
	Self-timer (p.140)	1	○	○	○	○	○	○	○
2		○	○	○	○	○	○	○	○
Built-in flash firing	A: Automatic firing	●	□	●	□	●	□	●	□
	: Flash on (Fires at all times)	○	□	○	○	○	□	○	○
	: Flash off	○	●	○	●	○	●	○	●
Ambience-based shots (p.108)		□	□	○	○	○	○	○	○
Light/scene-based shots (p.112)		□	□	□	□	○	□	□	□
Background blur (p.86)		□	□	○	□	□	□	□	□
Color tone (p.89, 91)		□	□	□	○	□	○	□	□

Function		SCN							
							*3	*4	
Drive mode (p.138)	: Single shooting	●	○	●	●	○	●	●	●
	H: High-speed continuous shooting	○	○	○	○	●	□	□	○
	L: Low-speed continuous shooting	○	●	○	○	○	□	□	○
	S: Silent single shooting ^{*2}	○	○	○	○	○	○	○	○
	S: Silent continuous shooting ^{*2}	○	○	○	○	○	□	□	○
	Self-timer (p.140)	1	○	○	○	○	○	○	○
2		○	○	○	○	○	○	○	○
Built-in flash firing	A: Automatic firing	□	●	□	●	□	○	●	□
	: Flash on (Fires at all times)	□	○	□	○	□	○	○	□
	: Flash off	●	○	●	○	●	○	○	●
Ambience-based shots (p.108)		□	○	○	○	○	□	□	□
Light/scene-based shots (p.112)		□	○	○	○	○	□	□	□
Adjustment of effects (p.101)		□	□	□	□	□	○	□	□

*1: If you change the shooting mode or set the power switch to <OFF>, all the functions will revert to the default settings (except the self-timer).

*2: Settable only with viewfinder shooting.

*3:

*4:

Shooting with Ambience Selection

In Basic Zone modes, when a mode other than <A+>, <A>, <SCN: < >, and < > is set, you can select the ambience for shooting.

Ambience	[CA]	SCN		Ambience Effect
		[A]/[A+]	[A-]/[A+]/[A+]/[A+]/[A+]/[A+]	
[STD] Standard setting	<input type="radio"/>	<input type="radio"/>	<input type="radio"/>	No setting
[V] Vivid	<input type="radio"/>	<input type="radio"/>	<input type="radio"/>	Low / Standard / Strong
[S] Soft	<input type="radio"/>	<input type="radio"/>	<input type="radio"/>	Low / Standard / Strong
[W] Warm	<input type="radio"/>	<input type="radio"/>	<input type="radio"/>	Low / Standard / Strong
[I] Intense	<input type="radio"/>	<input type="radio"/>	<input type="radio"/>	Low / Standard / Strong
[C] Cool	<input type="radio"/>	<input type="radio"/>	<input type="radio"/>	Low / Standard / Strong
[B] Brighter	<input type="radio"/>	<input type="radio"/>	<input type="radio"/>	Low / Medium / High
[D] Darker	<input type="radio"/>	<input type="radio"/>	<input type="radio"/>	Low / Medium / High
[M] Monochrome	<input type="radio"/>	<input type="radio"/>	<input type="radio"/>	Blue / B/W / Sepia

1 Set the Mode Dial to <[CA]> or <SCN>.

- For <SCN>, set a shooting mode other than < >.

2 Set the Live View shooting/Movie shooting switch to < >.

3 Display the Live View image.

- Press the <START/STOP> button to display the Live View image (except <[A+]>).

4 With Quick Control, select the desired ambience.

- Press the <[Q]> button (< >).
- Press the <▲> <▼> keys to select [STD Standard setting]. [Ambience-based shots] will appear on the screen.
- Press the <◀> <▶> keys to select the desired ambience.
- The LCD monitor will display how the image will look with the selected ambience.

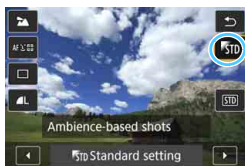



5 Set the ambience effect.

- Press the <▲> <▼> keys to select the effect so that **[Effect]** appears at the bottom of the screen.
- Press the <◀> <▶> keys to select the desired effect.

6 Take the picture.

- Press the shutter button completely to take the picture.
- To return to viewfinder shooting, press the <START/STOP> button to exit Live View shooting. Then press the shutter button completely to take the picture.
- If you change the shooting mode or set the power switch to <OFF>, the setting will revert back to **[STD Standard setting]**.



- The Live View image shown with the ambience setting applied will not look exactly the same as the actual image.
- Using flash may reduce the ambience effect.
- In bright outdoors, the Live View image you see on the LCD monitor may not have exactly the same brightness or ambience as the actual image. Set [**Y2: LCD brightness**] to 4, and look at the Live View image so that the LCD monitor is unaffected by outside light.





If you do not want the Live View image to be displayed when setting functions, press the <Q> button after step 1 and set **[Ambience-based shots]** and **[Effect]**.

Ambience Settings

Standard setting

Standard image characteristics for the respective shooting mode.

Note that < > has image characteristics geared for portraits and < > is geared for landscapes. Each ambience is a modification of the respective shooting mode's image characteristics.

Vivid

The subject will look sharp and vivid. It makes the photo look more impressive than with [ **Standard setting**].

Soft

The subject will look softer and more dainty. Good for portraits, pets, flowers, etc.

Warm

The subject will look softer with warmer colors. Good for portraits, pets, and other subjects to which you want to give a warm look.

Intense

While the overall brightness is slightly lowered, the subject is emphasized for a more intense feeling. Makes the human or living subject stand out more.

Cool

The overall brightness is slightly lowered with a cooler color cast. A subject in the shade will look more calm and impressive.

B Brighter

The picture will look brighter.





D Darker

The picture will look darker.











M Monochrome

The picture will be monochrome. You can select the monochrome color to be blue, black and white, or sepia. When **[Monochrome]** is selected, <  > will appear in the viewfinder.



Shooting by Lighting or Scene Type

In the <SCN:      > Basic Zone modes, you can shoot with the settings matching the lighting or scene type. Normally, [STD] **Default setting**] is adequate, but if the settings match the lighting condition or scene, the picture will look more accurate to your eyes.

For Live View shooting, if you set both [**Light/scene-based shots**] and [**Ambience-based shots**] (p.108), you should first set [**Light/scene-based shots**]. This will make it easier to see the resulting effect on the LCD monitor.

Lighting or Scene	SCN				
					
[STD] Default setting	<input type="radio"/>	<input type="radio"/>	<input type="radio"/>	<input type="radio"/>	<input type="radio"/>
 Daylight	<input type="radio"/>	<input type="radio"/>	<input type="radio"/>	<input type="radio"/>	<input type="radio"/>
 Shade	<input type="radio"/>	<input type="radio"/>	<input type="radio"/>	<input type="radio"/>	<input type="radio"/>
 Cloudy	<input type="radio"/>	<input type="radio"/>	<input type="radio"/>	<input type="radio"/>	<input type="radio"/>
 Tungsten light	<input type="radio"/>	<input type="radio"/>	<input checked="" type="radio"/>	<input type="radio"/>	<input type="radio"/>
 Fluorescent light	<input type="radio"/>	<input type="radio"/>	<input checked="" type="radio"/>	<input type="radio"/>	<input type="radio"/>
 Sunset	<input type="radio"/>	<input type="radio"/>	<input type="radio"/>	<input type="radio"/>	<input type="radio"/>

1 Set the Mode Dial to <SCN>.

- Set one of the following: < >, < >, < >, < >, or < >.

2 Set the Live View shooting/Movie shooting switch to < >.

3 Display the Live View image.

- Press the < > button to display the Live View image.



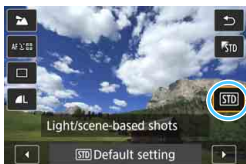

4 With Quick Control, select the lighting or scene type.

- Press the <[Q]> button (10).
- Press the <▲> <▼> keys to select [STD **Default setting**]. [Light/scene-based shots] will appear on the screen.
- Press the <◀> <▶> keys to select the lighting or scene type.
- ▶ The resulting image with the selected lighting or scene type will be displayed.

5 Take the picture.

- Press the shutter button completely to take the picture.
- To return to viewfinder shooting, press the <START/STOP> button to exit Live View shooting. Then press the shutter button completely to take the picture.
- If you change the shooting mode or set the power switch to <OFF>, the setting will revert back to [STD **Default setting**].



- If you use flash, the setting will switch to [STD **Default setting**]. (However, the shooting information will display the lighting or scene type that is set.)
- If you want to set this together with [Ambience-based shots], set the lighting or scene type that best matches the ambience you have set. In the case of [Sunset], for example, warm colors will become prominent so the ambience you set may not work well.



If you do not want the Live View image to be displayed when setting functions, press the <[Q]> button after step 1 and set [Light/scene-based shots].

Lighting or Scene Type Settings

Default setting

Default setting suited for most subjects.

Daylight

For subjects under sunlight. Gives more natural-looking blue skies and greenery and reproduces light-colored flowers better.

Shade

For subjects in the shade. Suitable for skin tones, which may look too bluish, and for light-colored flowers.

Cloudy

For subjects under overcast skies. Makes skin tones and landscapes, which may otherwise look dull on a cloudy day, look warmer. Also effective for light-colored flowers.

Tungsten light

For subjects lit under tungsten lighting. Reduces the reddish-orange color cast caused by tungsten lighting.

Fluorescent light

For subjects under fluorescent lighting. Suited for all types of fluorescent lighting.

Sunset

Suitable when you want to capture the sunset's impressive colors.

3

Setting the AF and Drive Modes

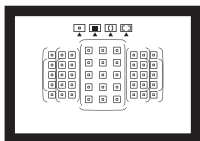

The AF points in the viewfinder are arranged to make AF shooting suitable for a wide variety of subjects and scenes.

You can also select the AF operation and drive mode that best match the shooting conditions and subject.

- The ☆ icon at the upper right of the page title indicates that the function is available only in Creative Zone modes (**P/Tv/Av/M/B**).
- In Basic Zone modes, the AF operation and AF point (AF area selection mode) are set automatically.



<AF> stands for autofocus. <MF> stands for manual focus.

AF: Selecting the AF Operation ☆

You can select the AF operation characteristics to suit the shooting conditions or subject. In Basic Zone modes, the optimum AF operation is set automatically for the respective shooting mode.

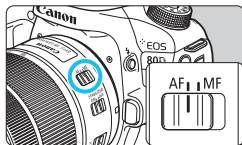

1 Set the lens's focus mode switch to <AF>.

2 Turn the Mode Dial to a Creative Zone mode.

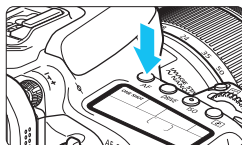

3 Press the <AF> button (Ⓞ6).

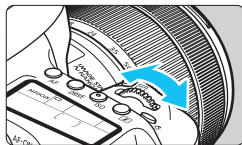

4 Select the AF operation.

- While looking at the LCD panel, turn the <⚙> or <⌚> dial.

ONE SHOT : One-Shot AF

AI FOCUS : AI Focus AF

AI SERVO : AI Servo AF

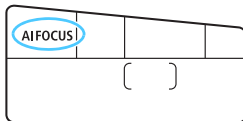

 In Creative Zone modes, you can also press the <AF-ON> button to autofocus.

One-Shot AF for Still Subjects

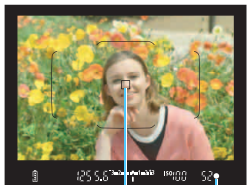

AF point

Focus indicator

Suited for still subjects. When you press the shutter button halfway, the camera will focus only once.

- When focus is achieved, the AF point that achieved focus will be displayed, and the focus indicator <●> in the viewfinder will also light up.
 - With evaluative metering, the exposure setting will be set at the same time focus is achieved.
- While you hold down the shutter button halfway, the focus will be locked. You can then recompose the shot if desired.



- If focus cannot be achieved, the focus indicator <●> in the viewfinder will blink. If this occurs, the picture cannot be taken even if the shutter button is pressed completely. Recompose the shot or see “When Autofocus Fails” (p.136) and try to focus again.
- If [CAM 1: Beep] is set to [Disable], the beeper will not sound when focus is achieved.
- After achieving focus with One-Shot AF, you can lock the focus on a subject and recompose the shot. This is called “focus lock”. This is useful when you want to focus on a peripheral subject not covered by the Area AF frame.
- When a lens equipped with electronic manual focusing function is used, after achieving focus, you can focus manually by turning the lens focusing ring while pressing the shutter button halfway.

AI Servo AF for Moving Subjects

This AF operation is suited for moving subjects when the focusing distance keeps changing. While you hold down the shutter button halfway, the camera will keep focusing on the subject continuously.

- The exposure is set at the moment the picture is taken.
- When the AF area selection mode (p.120) is set to 45-point automatic selection AF, focus tracking will continue as long as the Area AF frame covers the subject.

 With AI Servo AF, the beeper will not sound even when focus is achieved. Also, the focus indicator <●> in the viewfinder will not light up.

AI Focus AF for Switching the AF Operation Automatically

AI Focus AF switches the AF operation from One-Shot AF to AI Servo AF automatically if a still subject starts moving.

- After the subject is focused in One-Shot AF, if the subject starts moving, the camera will detect the movement, change the AF operation automatically to AI Servo AF, and start tracking the moving subject.



 When focus is achieved with AI Focus AF with the Servo operation active, the beeper will continue beeping softly. However, the focus indicator <●> in the viewfinder will not light up. Note that focus will not be locked in this case.

AF Points Lighting Up in Red

By default, the AF points light up in red when focus is achieved in low-light conditions. In Creative Zone modes, you can set whether to have the AF points light up in red when focus is achieved (p.424).

AF-Assist Beam with the Built-in Flash

Under low-light conditions, when you press the shutter button halfway, the built-in flash may fire a brief burst of flashes. This illuminates the subject to help autofocusing.

- 
 - AF-assist beam will not be emitted from the built-in flash in or <SCN:  > modes, or when [Built-in flash firing] is set to in , , <SCN:  >, or modes.
 - The AF-assist beam will not be emitted with AI Servo AF operation.
 - The built-in flash makes a sound when firing continuously. This is normal and not a malfunction.

- 
 - The effective range of the AF-assist beam emitted by the built-in flash is approx. 4 meters / 13.1 feet.
 - In Creative Zone modes, when you raise the built-in flash with the button, the AF-assist beam will fire when necessary. Note that depending on the setting for [C.Fn II-6: AF-assist beam firing], the AF-assist beam may not be emitted (p.419).

Selecting the AF Area and AF Point[☆]

The camera has 45 AF points for autofocus. You can select the AF area selection mode and AF point(s) suiting the scene or subject.

 Depending on the lens attached to the camera, the number of usable AF points, AF point patterns, the shape of Area AF frame, etc. will differ. For details, see “Lenses and Usable AF Points” on page 128.

AF Area Selection Mode

You can select one of four AF area selection modes. See the next page for the selection procedure.

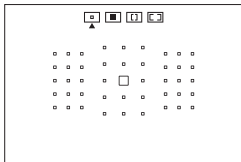

Single-point AF **(Manual selection)**

Select one AF point to focus.

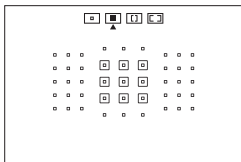

Zone AF **(Manual selection of zone)**

The AF area is divided into nine focusing zones for focusing.

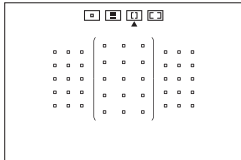

Large Zone AF **(Manual selection of zone)**

The AF area is divided into three focusing zones (left, center, and right) for focusing.

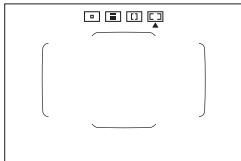

45-point automatic selection AF

The Area AF frame (entire AF area) is used to focus.

Selecting the AF Area Selection Mode

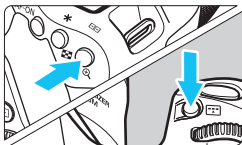

1 Press the or button (⌚6).

- Look through the viewfinder and press the or button.

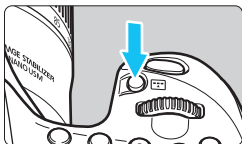

2 Press the button.

- Each time you press the button, the AF area selection mode changes.
- The AF area selection mode currently set is indicated on the top of the viewfinder.

AF area selection mode

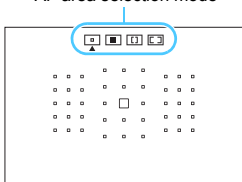

- With [C.Fn II-8: Select AF area selec. mode], you can limit the selectable AF area selection modes (p.420).
- If you set [C.Fn II-9: AF area selection method] to [1: → Main Dial], you can select the AF area selection mode by pressing the or button, then turning the dial (p.420).

Selecting the AF Point Manually

You can manually select the AF point or zone.

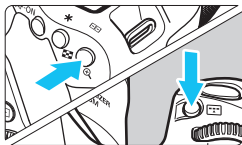

1 Press the <☰> or <☒> button (Ⓜ6).

- ▶ The AF points will be displayed in the viewfinder.
- In the Zone AF mode or Large Zone AF mode, the selected zone will be displayed.

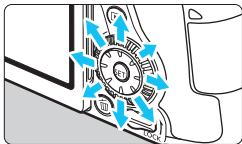

2 Select an AF point.

- The AF point selection will change in the direction you tilt <☼>. If you press <SET>, the center AF point (or center zone) will be selected.
- You can also select an AF point by shifting horizontally with the <☰> dial or vertically with the <☼> dial.
- In the Zone AF mode, turning the <☰> or <☼> dial will change the zone in a looping sequence.

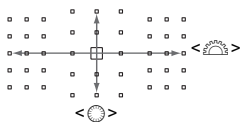

- When you hold down the <Q> button and turn the <☰> dial, you can select an AF point by shifting vertically.
- When [☰.C.Fn II-11: Initial AFpt, ☒ AI Servo AF] is set to [1: Initial ☒ AF pt selected] (p.422), you can use this method to manually select the AI Servo's AF initial position.
- When you press the <☰> or <☒> button, the LCD panel displays the following:
 - Zone AF, Large Zone AF, and 45-point automatic selection AF: [☒] AF
 - 1 pt AF: SEL [] (Center)/SEL AF (Off-center)

AF Point Display Indications

Pressing the <[AF Area Icon]> or <[AF Point Icon]> button lights up the AF points that are cross-type AF points for high-precision autofocusing. The blinking AF points are horizontal-line or vertical-line sensitive. For details, see pages 127-131.

AF Area Selection Modes

Single-point AF (Manual Selection)



Select one AF point <□> to be used for focusing.

Zone AF (Manual Selection of Zone)

The AF area is divided into nine focusing zones for focusing. All the AF points in the selected zone are used for the automatic AF point selection. It is superior to single-point AF in tracking the subject, and it is effective for moving subjects.

However, since it is inclined to focus on the nearest subject, focusing on a specific target may be more difficult.

The AF point(s) achieving focus is displayed as <□>.

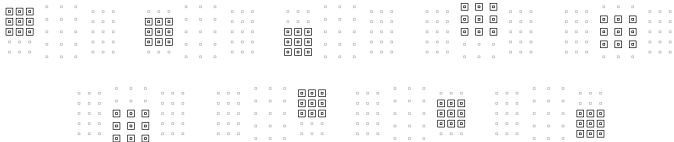

Large Zone AF (Manual Selection of Zone)



The AF area is divided into three focusing zones (left, center, and right) for focusing. Since the focusing area is larger than with Zone AF and all the AF points in the selected zone are used for the automatic AF point selection, it is superior to single-point AF in tracking the subject, and it is effective for moving subjects.

However, since it is inclined to focus on the nearest subject, focusing on a specific target may be more difficult.

The AF point(s) achieving focus is displayed as <□>.



45-point Automatic Selection AF



The Area AF frame (entire AF area) is used to focus. **This mode is set automatically in Basic Zone modes** (except <SCN: > and <: />).

The AF point(s) achieving focus is displayed as <>.

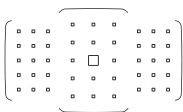

With One-Shot AF, pressing the shutter button halfway will display the AF point(s) <> that achieved focus. If multiple AF points are displayed, it means they all have achieved focus. This mode tends to focus on the nearest subject.



With AI Servo AF, you can set the AI Servo AF's starting position with [.C.Fn II-11: Initial AFpt,  AI Servo AF] (p.422). As long as the Area AF frame can track the subject during shooting, focusing will continue.



- When AI Servo AF mode is set with 45-point automatic selection AF, Large Zone AF, or Zone AF, the active AF point <> will keep switching to track the subject. However, under certain shooting conditions (such as when the subject is small), it may not be able to track the subject.
- If a peripheral AF point or a wide-angle lens is used, achieving focus may be difficult with an EOS-dedicated, external Speedlite's AF-assist beam. In such a case, use an AF point closer to the center.
- When the AF point(s) light up, part or all of the viewfinder may light up in red. This is a characteristic of AF point display.
- In low temperatures, the AF point's display may be difficult to see. This is a characteristic of AF point display. Also, the tracking response may become slower.



With [.C.Fn II -10: Orientation linked AF point], you can set the AF area selection mode + AF point, or only the AF point separately for the horizontal and vertical orientations (p.421).

AF Using Color Tracking

By default, AF will be performed based on color tracking.

When the AF area selection mode is set to Zone AF, Large Zone AF, or 45-point automatic selection AF, focus is achieved as follows:

- **In One-Shot AF Mode**

Focusing on a still human subject in the AF area is made easier.

- **In AI Servo AF Mode**

Focusing on a human subject in the AF area is made easier. If no skin tones can be detected, the nearest subject will be focused on. Once focus is achieved, AF points are automatically selected so that the camera continues to focus on the color of the area it focused on first.

* In [ **C.FnII-12 Auto AF pt sel.:Color Tracking**], you can set whether to perform AF by tracking colors. If [**1: Disable**] is set, focus is achieved based only on AF information (p.422).



AF Sensor

The camera's AF sensor has 45 AF points. The illustration below shows the AF sensor pattern corresponding to each AF point. When using lenses with a maximum aperture of $f/2.8$ or faster, high-precision AF is possible with the center AF point in the viewfinder.

Depending on the lens attached to the camera, the number of usable AF points, AF point patterns, the shape of Area AF frame, etc. vary. For details, see "Lenses and Usable AF Points" on page 128.

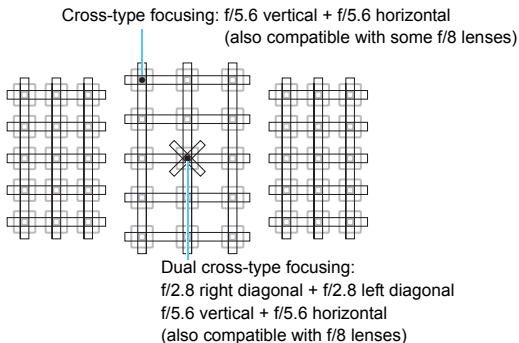



Diagram



	<p>The focusing sensor is geared to obtain higher precision focusing for lenses with a maximum aperture of $f/2.8$ or faster. A diagonal cross pattern makes it easier to focus on subjects difficult for AF. It is provided at the center AF point.</p>
	<p>The focusing sensor is geared for lenses with a maximum aperture of $f/5.6$ or faster (and some $f/8$ lenses). Since it has a horizontal pattern, it can detect vertical lines. It covers all 45 AF points.</p>
	<p>The focusing sensor is geared for lenses with a maximum aperture of $f/5.6$ or faster (and some $f/8$ lenses). Since it has a vertical pattern, it can detect horizontal lines. It covers all 45 AF points.</p>

Lenses and Usable AF Points

- Although the camera has 45 AF points, **the number of usable AF points and focusing patterns vary depending on the lens. The lenses are thereby classified into eight groups from A to H.**
- **When using a lens in Groups E to H, fewer AF points will be usable.**
- **See which group each lens belongs to on pages 132-135. Check which group the lens in use belongs to.**
- The number of available AF points varies depending on aspect ratio settings (p.146).

- When you press the  or  button, the AF points indicated by the  mark will blink. (The /  AF points will stay lit.) Regarding lighting up or blinking of the AF points, see page 123.
- For the latest “Lens Group Designations” information, check the Canon Web site.
- Some lenses may not be available in certain countries or regions.

Group A

Autofocusing with 45 points is possible. All the AF area selection modes are selectable.



- : Dual cross-type AF point. Subject tracking is superior and the focusing precision is higher than with other AF points.
- : Cross-type AF point. Subject tracking is superior and high-precision focusing is achieved.

Group B

Autofocusing with 45 points is possible. All the AF area selection modes are selectable.



- : Cross-type AF point. Subject tracking is superior and high-precision focusing is achieved.

Group C

Autofocusing with 45 points is possible. All the AF area selection modes are selectable.



- : Cross-type AF point. Subject tracking is superior and high-precision focusing is achieved.
- : AF points sensitive to horizontal lines.

Group D

Autofocusing with 45 points is possible. All the AF area selection modes are selectable.

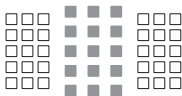

- : Cross-type AF point. Subject tracking is superior and high-precision focusing is achieved.
- : AF points sensitive to horizontal lines.

Group E

Autofocusing with only 35 points is possible. (Not possible with all 45 AF points.) All the AF area selection modes are selectable. During automatic AF point selection, the outer frame marking the AF area (Area AF frame) will be different from 45-point automatic selection AF.



- : Cross-type AF point. Subject tracking is superior and high-precision focusing is achieved.
- : AF points sensitive to horizontal lines.
- : Disabled AF points (not displayed).

Group F

Autofocusing with only 35 points is possible. (Not possible with all 45 AF points.) All the AF area selection modes are selectable. During automatic AF point selection, the outer frame marking the AF area (Area AF frame) will be different from 45-point automatic selection AF.

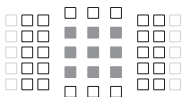

- : Cross-type AF point. Subject tracking is superior and high-precision focusing is achieved.
- : AF points sensitive to vertical lines (AF points in the horizontal array at the top and bottom) or horizontal lines (AF points in a vertical array on the left and right).
- : Disabled AF points (not displayed).

Group G

Autofocusing with only 27 points is possible. (Not possible with all 45 AF points.) Large Zone AF (manual selection of zone) cannot be selected for AF area selection mode. During automatic AF point selection, the outer frame marking the AF area (Area AF frame) will be different from 45-point automatic selection AF.



- : Cross-type AF point. Subject tracking is superior and high-precision focusing is achieved.
- : AF points sensitive to horizontal lines.
- : Disabled AF points (not displayed).

Group H

Autofocusing is possible only with the center AF point.



- : Cross-type AF point. Subject tracking is superior and high-precision focusing is achieved.
- : Disabled AF points (not displayed).



- If the maximum aperture is slower than $f/5.6$ (greater than $f/5.6$ but not exceeding $f/8$), focus may not be achieved with AF when shooting low-contrast or low-light subjects.
- If the maximum aperture is slower than $f/8$ (greater than $f/8$), AF is not possible during viewfinder shooting.

Lens Group Designations (as of the release of EOS 80D (W))

EF-S24mm f/2.8 STM	A	EF50mm f/1.0L USM	A
EF-S60mm f/2.8 Macro USM	B	EF50mm f/1.2L USM	A
EF-S10-18mm f/4.5-5.6 IS STM	D	EF50mm f/1.4 USM	A
EF-S10-22mm f/3.5-4.5 USM	B	EF50mm f/1.8	A
EF-S15-85mm f/3.5-5.6 IS USM	B	EF50mm f/1.8 II	A
EF-S17-55mm f/2.8 IS USM	A	EF50mm f/1.8 STM	A
EF-S17-85mm f/4-5.6 IS USM	B	EF50mm f/2.5 Compact Macro	B
EF-S18-55mm f/3.5-5.6	C	EF50mm f/2.5 Compact Macro + LIFE SIZE Converter	B
EF-S18-55mm f/3.5-5.6 USM	C	EF85mm f/1.2L USM	A
EF-S18-55mm f/3.5-5.6 II	C	EF85mm f/1.2L II USM	A
EF-S18-55mm f/3.5-5.6 II USM	C	EF85mm f/1.8 USM	A
EF-S18-55mm f/3.5-5.6 III	B	EF100mm f/2 USM	A
EF-S18-55mm f/3.5-5.6 IS	C	EF100mm f/2.8 Macro	B
EF-S18-55mm f/3.5-5.6 IS II	B	EF100mm f/2.8 Macro USM	E
EF-S18-55mm f/3.5-5.6 IS STM	B	EF100mm f/2.8L Macro IS USM	B
EF-S18-135mm f/3.5-5.6 IS	B	EF135mm f/2L USM	A
EF-S18-135mm f/3.5-5.6 IS USM	B	EF135mm f/2L USM + Extender EF1.4x I/II/III	A
EF-S18-135mm f/3.5-5.6 IS STM	B	EF135mm f/2L USM + Extender EF2x I/II/III	B
EF-S18-200mm f/3.5-5.6 IS	B	EF135mm f/2.8 (Softfocus)	A
EF-S55-250mm f/4-5.6 IS	B	EF180mm f/3.5L Macro USM	B
EF-S55-250mm f/4-5.6 IS II	B	EF180mm f/3.5L Macro USM + Extender EF1.4x I/II/III	F
EF-S55-250mm f/4-5.6 IS STM	B	EF200mm f/1.8L USM	A
EF14mm f/2.8L USM	A	EF200mm f/1.8L USM + Extender EF1.4x I/II/III	A*
EF14mm f/2.8L II USM	A	EF200mm f/1.8L USM + Extender EF2x I/II/III	B*
EF15mm f/2.8 Fisheye	A	EF200mm f/2L IS USM	A
EF20mm f/2.8 USM	A	EF200mm f/2L IS USM + Extender EF1.4x I/II/III	A
EF24mm f/1.4L USM	A	EF200mm f/2L IS USM + Extender EF2x I/II/III	B
EF24mm f/1.4L II USM	A	EF200mm f/2.8L USM	A
EF24mm f/2.8	A	EF200mm f/2.8L USM + Extender EF1.4x I/II/III	B
EF24mm f/2.8 IS USM	A	EF200mm f/2.8L USM + Extender EF2x I/II/III	B
EF28mm f/1.8 USM	A	EF200mm f/2.8L USM	A
EF28mm f/2.8	A	EF200mm f/2.8L USM + Extender EF1.4x I/II/III	B
EF28mm f/2.8 IS USM	A	EF200mm f/2.8L USM	A
EF35mm f/1.4L USM	A	EF200mm f/2.8L USM + Extender EF1.4x I/II/III	B
EF35mm f/1.4L II USM	A	EF200mm f/2.8L USM + Extender EF2x I/II/III	B
EF35mm f/2	A	EF200mm f/2.8L USM + Extender EF2x I/II/III	B
EF35mm f/2 IS USM	A	EF200mm f/2.8L USM	A
EF40mm f/2.8 STM	A	EF200mm f/2.8L II USM	A

EF200mm f/2.8L II USM + Extender EF1.4x I/II/III	B	EF400mm f/2.8L IS II USM + Extender EF1.4x I/II/III	B
EF200mm f/2.8L II USM + Extender EF2x I/II/III	B	EF400mm f/2.8L IS II USM + Extender EF2x I/II/III	B
EF300mm f/2.8L USM	A	EF400mm f/4 DO IS USM	B
EF300mm f/2.8L USM + Extender EF1.4x I/II/III	B*	EF400mm f/4 DO IS USM + Extender EF1.4x I/II/III	B
EF300mm f/2.8L USM + Extender EF2x I/II/III	B*	EF400mm f/4 DO IS USM + Extender EF2x I/II/III	H (f/8)
EF300mm f/2.8L IS USM	A	EF400mm f/4 DO IS II USM	B
EF300mm f/2.8L IS USM + Extender EF1.4x I/II/III	B	EF400mm f/4 DO IS II USM + Extender EF1.4x I/II/III	B
EF300mm f/2.8L IS USM + Extender EF2x I/II/III	B	EF400mm f/4 DO IS II USM + Extender EF2x I/II/III	H (f/8)
EF300mm f/2.8L IS II USM	A	EF400mm f/5.6L USM	B
EF300mm f/2.8L IS II USM + Extender EF1.4x I/II/III	B	EF400mm f/5.6L USM + Extender EF1.4x I/II/III	H (f/8)
EF300mm f/2.8L IS II USM + Extender EF2x I/II/III	B	EF500mm f/4L IS USM	B
EF300mm f/4L USM	B	EF500mm f/4L IS USM + Extender EF1.4x I/II/III	B
EF300mm f/4L USM + Extender EF1.4x I/II/III	B	EF500mm f/4L IS USM + Extender EF2x I/II/III	H (f/8)
EF300mm f/4L USM + Extender EF2x I/II/III	H (f/8)	EF500mm f/4L IS II USM	B
EF300mm f/4L IS USM	B	EF500mm f/4L IS II USM + Extender EF1.4x I/II/III	B
EF300mm f/4L IS USM + Extender EF1.4x I/II/III	B	EF500mm f/4L IS II USM + Extender EF2x I/II/III	H (f/8)
EF300mm f/4L IS USM + Extender EF2x I/II/III	H (f/8)	EF500mm f/4.5L USM	B
EF400mm f/2.8L USM	A	EF500mm f/4.5L USM + Extender EF1.4x I/II/III	H (f/8)*
EF400mm f/2.8L USM + Extender EF1.4x I/II/III	B*	EF600mm f/4L USM	B
EF400mm f/2.8L USM + Extender EF2x I/II/III	B*	EF600mm f/4L USM + Extender EF1.4x I/II/III	B*
EF400mm f/2.8L II USM	A	EF600mm f/4L USM + Extender EF2x I/II/III	H (f/8)*
EF400mm f/2.8L II USM + Extender EF1.4x I/II/III	B*	EF600mm f/4L IS USM	B
EF400mm f/2.8L II USM + Extender EF2x I/II/III	B*	EF600mm f/4L IS USM + Extender EF1.4x I/II/III	B
EF400mm f/2.8L IS USM	A	EF600mm f/4L IS USM + Extender EF2x I/II/III	H (f/8)
EF400mm f/2.8L IS USM + Extender EF1.4x I/II/III	B	EF600mm f/4L IS II USM	B
EF400mm f/2.8L IS USM + Extender EF2x I/II/III	B	EF600mm f/4L IS II USM + Extender EF1.4x I/II/III	B
EF400mm f/2.8L IS II USM	A	EF600mm f/4L IS II USM + Extender EF2x I/II/III	H (f/8)
		EF800mm f/5.6L IS USM	E

Lenses and Usable AF Points

EF800mm f/5.6L IS USM + Extender EF1.4x I/II/III	H (f/8)	EF28-135mm f/3.5-5.6 IS USM	B
EF1200mm f/5.6L USM	E	EF28-200mm f/3.5-5.6	B
EF1200mm f/5.6L USM + Extender EF1.4x I/II/III	H (f/8)*	EF28-200mm f/3.5-5.6 USM	B
EF8-15mm f/4L Fisheye USM	B	EF28-300mm f/3.5-5.6L IS USM	B
EF11-24mm f/4L USM	C	EF35-70mm f/3.5-4.5	E
EF16-35mm f/2.8L USM	A	EF35-70mm f/3.5-4.5A	E
EF16-35mm f/2.8L II USM	A	EF35-80mm f/4-5.6	F
EF16-35mm f/4L IS USM	B	EF35-80mm f/4-5.6 PZ	E
EF17-35mm f/2.8L USM	A	EF35-80mm f/4-5.6 USM	F
EF17-40mm f/4L USM	B	EF35-80mm f/4-5.6 II	E
EF20-35mm f/2.8L	A	EF35-80mm f/4-5.6 III	F
EF20-35mm f/3.5-4.5 USM	C	EF35-105mm f/3.5-4.5	B
EF22-55mm f/4-5.6 USM	F	EF35-105mm f/4.5-5.6	H
EF24-70mm f/2.8L USM	A	EF35-105mm f/4.5-5.6 USM	H
EF24-70mm f/2.8L II USM	A	EF35-135mm f/3.5-4.5	B
EF24-70mm f/4L IS USM	B	EF35-135mm f/4-5.6 USM	C
EF24-85mm f/3.5-4.5 USM	D	EF35-350mm f/3.5-5.6L USM	D
EF24-105mm f/3.5-5.6 IS STM	B	EF38-76mm f/4.5-5.6	E
EF24-105mm f/4L IS USM	B	EF50-200mm f/3.5-4.5	B
EF28-70mm f/2.8L USM	A	EF50-200mm f/3.5-4.5L	B
EF28-70mm f/3.5-4.5	E	EF55-200mm f/4.5-5.6 USM	D
EF28-70mm f/3.5-4.5 II	E	EF55-200mm f/4.5-5.6 II USM	D
EF28-80mm f/2.8-4L USM	B	EF70-200mm f/2.8L USM	A
EF28-80mm f/3.5-5.6	E	EF70-200mm f/2.8L USM + Extender EF1.4x I/II/III	B**
EF28-80mm f/3.5-5.6 USM	E	EF70-200mm f/2.8L USM + Extender EF2x I/II/III	B**
EF28-80mm f/3.5-5.6 II	E	EF70-200mm f/2.8L IS USM	A
EF28-80mm f/3.5-5.6 II USM	E	EF70-200mm f/2.8L IS USM + Extender EF1.4x I/II/III	B
EF28-80mm f/3.5-5.6 III USM	E	EF70-200mm f/2.8L IS USM + Extender EF2x I/II/III	B
EF28-80mm f/3.5-5.6 IV USM	E	EF70-200mm f/2.8L IS II USM	A
EF28-80mm f/3.5-5.6 V USM	E	EF70-200mm f/2.8L IS II USM + Extender EF1.4x I/II/III	B
EF28-90mm f/4-5.6	B	EF70-200mm f/2.8L IS II USM + Extender EF2x I/II/III	B
EF28-90mm f/4-5.6 USM	B	EF70-200mm f/4L USM	B
EF28-90mm f/4-5.6 II	B	EF70-200mm f/4L USM + Extender EF1.4x I/II/III	B
EF28-90mm f/4-5.6 II USM	B	EF70-200mm f/4L USM + Extender EF2x I/II/III	H (f/8)
EF28-90mm f/4-5.6 III	B		
EF28-105mm f/3.5-4.5 USM	B		
EF28-105mm f/3.5-4.5 II USM	B		
EF28-105mm f/4-5.6	F		
EF28-105mm f/4-5.6 USM	F		

EF70-200mm f/4L IS USM	B	EF100-300mm f/5.6L	B
EF70-200mm f/4L IS USM + Extender EF1.4x I/II/III	B	EF100-400mm f/4.5-5.6L IS USM	B
EF70-200mm f/4L IS USM + Extender EF2x I/II/III	H (f/8)	EF100-400mm f/4.5-5.6L IS USM + Extender EF1.4x I/II/III	H (f/8)
EF70-210mm f/3.5-4.5 USM	B	EF100-400mm f/4.5-5.6L IS II USM	B
EF70-210mm f/4	B	EF100-400mm f/4.5-5.6L IS II USM + Extender EF1.4x I/II	H (f/8)
EF70-300mm f/4-5.6 IS USM	B	EF100-400mm f/4.5-5.6L IS II USM + Extender EF1.4x III	G (f/8)
EF70-300mm f/4-5.6L IS USM	B	EF200-400mm f/4L IS USM Extender 1.4x	B
EF70-300mm f/4-5.6 DO IS USM	B	EF200-400mm f/4L IS USM Extender 1.4x: With built-in Ext.1.4x	B
EF75-300mm f/4-5.6	B	EF200-400mm f/4L IS USM Extender 1.4x + Extender EF1.4x I/II/III	B
EF75-300mm f/4-5.6 USM	C	EF200-400mm f/4L IS USM Extender 1.4x: With built-in Ext.1.4x + Extender EF1.4x I/II/III	H (f/8)
EF75-300mm f/4-5.6 II	B	EF200-400mm f/4L IS USM Extender 1.4x + Extender EF2x I/II	H (f/8)
EF75-300mm f/4-5.6 II USM	B	EF200-400mm f/4L IS USM Extender 1.4x + Extender EF2x III	G (f/8)
EF75-300mm f/4-5.6 III	B	TS-E17mm f/4L	B
EF75-300mm f/4-5.6 III USM	B	TS-E24mm f/3.5L	B
EF75-300mm f/4-5.6 IS USM	B	TS-E24mm f/3.5L II	B
EF80-200mm f/2.8L	A	TS-E45mm f/2.8	A
EF80-200mm f/4-5-5.6	D	TS-E90mm f/2.8	A
EF80-200mm f/4-5-5.6 USM	E		
EF80-200mm f/4-5-5.6 II	E		
EF90-300mm f/4-5-5.6	D		
EF90-300mm f/4.5-5.6 USM	D		
EF100-200mm f/4.5A	B		
EF100-300mm f/4.5-5.6 USM	C		
EF100-300mm f/5.6	B		



- If Extender EF2x (I/II/III) is attached to the EF180mm f/3.5L Macro USM lens, AF is not possible.
- When using a lens and Extender EF1.4x III/EF2x III in a combination marked with an asterisk (*) or when using a lens and extender in a combination marked with two asterisks (**), precise focus may not be achieved with AF. In such a case, refer to the Instruction Manual of the lens or extender used.



If you use a TS-E lens, manual focusing will be required. The lens group designation of TS-E lenses applies only when you do not use tilt or shift function.

When Autofocus Fails

Autofocus may fail to achieve focus (viewfinder's focus indicator <●> blinks) with certain subjects such as the following:

Subjects Difficult to Focus

- Subjects with very low contrast
(Example: Blue skies, solid-color flat surfaces, etc.)
- Subjects in very low light
- Strongly backlit or reflective subjects
(Example: Cars with highly reflective bodies, etc.)
- Near and distant subjects framed close to an AF point
(Example: Animals in cages, etc.)
- Subjects such as dots of light framed close to an AF point
(Example: Night scenes, etc.)
- Subjects with repetitive patterns
(Example: Skyscraper windows, computer keyboards, etc.)

In such a case, focus by doing either of the following:

- (1) With One-Shot AF, focus on an object at the same distance as the subject and lock the focus, then recompose the shot (p.81).
- (2) Set the lens's focus mode switch to <MF> and focus manually (p.137).



- Depending on the subject, focus may be achieved by slightly recomposing the shot and performing AF operation again.
- Conditions that make focusing difficult with AF during Live View shooting or movie shooting are listed on page 284.

MF: Manual Focus

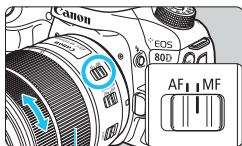

Focusing ring

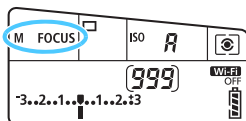

1 Set the lens's focus mode switch to <MF>.

- ▶ <M FOCUS> will be displayed on the LCD panel.

2 Focus on the subject.

- Focus by turning the lens's focusing ring until the subject looks sharp in the viewfinder.



- If you press the shutter button halfway during manual focusing, the AF point that achieved focus and the focus indicator <●> will light up in the viewfinder.
- With 45-point automatic selection AF, when the center AF point achieves focus, the focus indicator <●> will light up.

Selecting the Drive Mode

Single and continuous drive modes are provided.

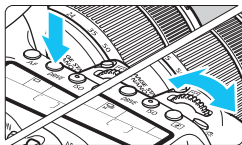

1 Press the <DRIVE> button (⚙️).

2 Select the drive mode.

- While looking at the LCD panel, turn the <⚙️> or <🕒> dial.

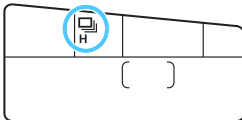

: **Single shooting**

When you press the shutter button completely, only one shot will be taken.

H: **High-speed continuous shooting** (Max. approx. 7.0 shots/sec.*)

While you hold down the shutter button completely, the camera will shoot continuously.

* During Live View shooting or when [Servo AF] is set, the maximum speed will be max. approx. 5.0 shots/sec.

: **Low-speed continuous shooting** (Max. approx. 3.0 shots/sec.)

While you hold down the shutter button completely, the camera will shoot continuously.

S: **Silent single shooting**

You can shoot one image at a time while suppressing the camera noise during viewfinder shooting.

S: **Silent continuous shooting** (Max. approx. 3.0 shots/sec.)

You can shoot continuously while suppressing the camera noise during viewfinder shooting.

: **10-sec. self-timer/remote control**













2: **2-sec. self-timer/remote control**

For self-timer shooting, see page 140. For remote control shooting, see page 221.



-  **H**: The maximum continuous shooting speed of approx. 7.0 shots/sec. is attained under the following conditions*: 1/500 sec. or faster shutter speed, maximum aperture (varies depending on the lens), Anti-flicker shooting set to Disable, with a fully-charged Battery Pack LP-E6N, and at room temperature (23°C/73°F). The continuous shooting speed may become slower depending on the shutter speed, aperture, subject conditions, brightness, lens, flash use, temperature, battery type, remaining battery level, etc.

* With the AF mode set to One-Shot AF and the Image Stabilizer turned off when using the following lenses: EF300mm f/4L IS USM, EF28-135mm f/3.5-5.6 IS USM, EF75-300mm f/4-5.6 IS USM, EF100-400mm f/4.5-5.6L IS USM.

-  If  S > or  S > is set, the time lag from when you press the shutter button completely until the picture is taken will be slightly longer than normal.
-  With Live View shooting,  S > and  S > cannot be set.
-  The continuous shooting speed may become slower if the remaining battery level is low or if you shoot under low-light conditions.
-  In AI Servo AF operation, the continuous shooting speed may become slightly slower depending on the subject and the lens used.
-  If you use Battery Grip BG-E14 (sold separately) with AA/R6 batteries, the high-speed continuous shooting speed may be slower.
-  If you set [ 4: **Anti-flicker shoot.**] to [**Enable**] (p.179) and shoot under a flickering light source, the continuous shooting speed may decrease slightly, the shooting interval may become irregular, or the release time lag may become longer.
-  When internal memory becomes full during continuous shooting, the continuous shooting speed may drop since shooting will be temporarily disabled (p.145).

🕒 Using the Self-timer

Use the self-timer when you want to be in the picture.

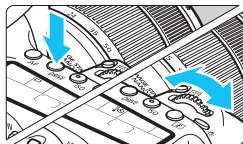

1 Press the <DRIVE> button (📷).

2 Select the self-timer.

- While looking at the LCD panel, turn the <📷> or <🕒> dial to select the self-timer delay.

📷🕒 : **Shoot in approx. 10 sec.**

📷🕒₂ : **Shoot in approx. 2 sec.**

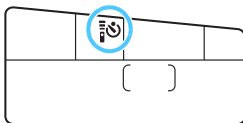

3 Take the picture.

- Look through the viewfinder, focus on the subject, then press the shutter button completely.
- ▶ You can check the self-timer operation with the self-timer lamp, beeper, and countdown display (in seconds) on the LCD panel.
- ▶ 2 sec. before the picture is taken, the self-timer lamp will light up and the beeper will sound faster.

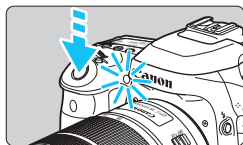

🔊 If you do not look through the viewfinder when you press the shutter button, attach the eyepiece cover (p.220). If stray light enters the viewfinder when the picture is taken, it may throw off the exposure.

- The <📷🕒> enables you to shoot while not touching the camera mounted on a tripod. This prevents camera vibration blur when you shoot still lifes or long exposures.
- After taking self-timer shots, playing back the image (p.346) to check focus and exposure is recommended.
- When using the self-timer to shoot yourself, use focus lock (p.81) on an object at the same distance as where you will stand.
- To cancel the self-timer after it starts, either touch the LCD monitor or press the <DRIVE> button.

4

Image Settings

This chapter explains image-related function settings: Image-recording quality, ISO speed, Picture Style, white balance, Auto Lighting Optimizer, noise reduction, lens aberration correction, anti-flicker shooting, and other functions.

- In Basic Zone modes, only the following can be set as described in this chapter: Image-recording quality, folder creation and selection, and image file numbering.
- The ☆ icon at the upper right of the page title indicates that the function is available only in Creative Zone modes (**P/Tv/Av/M/B**).

MENU Setting the Image-Recording Quality

You can select the pixel count and the image quality. There are eight JPEG image-recording quality settings: **L**, **L**, **M**, **M**, **S1**, **S1**, **S2**, **S3**. There are three RAW image quality settings: **RAW**, **M RAW**, **S RAW** (p.144).

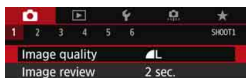

1 Select [Image quality].

- Under the [1] tab, select [Image quality], then press <SET>.

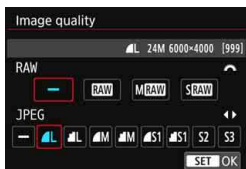

2 Set the image-recording quality.

- To select a RAW setting, turn the <DIAL> dial. To select a JPEG setting, press the <LEFT> <RIGHT> keys.
- On the upper right of the screen, “***M (megapixels) ****x****” indicates the recorded pixel count, and [***] is the number of possible shots (displayed up to 999).
- Press <SET> to set it.

Image-recording Quality Setting Examples

L only

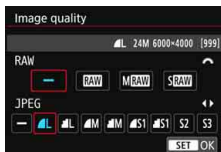

RAW + **L**

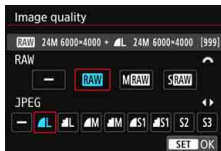

RAW only

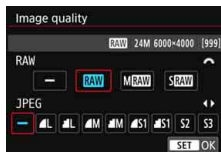

S RAW + **M**

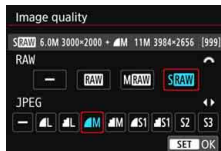

The image size [****x****] and number of possible shots [***] for the [3:2] aspect ratio will always be displayed on the image-recording quality setting screen regardless of the [4: Aspect ratio] setting (p.146).

If [-] is set for both RAW and JPEG, **L** will be set.

Guide to Image-Recording Quality Settings (Approx.)



Image Quality		Pixels Recorded	Printing Size	File Size (MB)	Possible Shots	Maximum Burst
JPEG	L	24M	A2	7.6	940	77 (110)
	L			3.9	1800	120 (120)
	M	11M	A3	4.1	1730	140 (140)
	M			2.0	3430	140 (140)
	S1	5.9M	A4	2.6	2700	140 (140)
	S1			1.3	5260	150 (150)
	S2 ^{*1}	2.5M	9x13 cm	1.3	5260	150 (150)
	S3 ^{*2}	0.3M	-	0.3	20180	150 (150)
RAW	RAW	24M	A2	28.9	240	20 (25)
	M RAW	14M	A3	22.8	300	21 (26)
	S RAW	6.0M	A4	15.9	440	27 (28)
RAW + JPEG	RAW L	24M 24M	A2 A2	28.9+7.6	190	20 (22)
	M RAW L	14M 24M	A3 A2			
	S RAW L	6.0M 24M	A4 A2	15.9+7.6	300	22 (22)

*1 : S2 is suitable for playing the images on a digital photo frame.

*2 : S3 is suitable for emailing the image or using it on a Web site.

- S2 and S3 will be in (Fine) quality.
- The file size, possible shots, and maximum burst during continuous shooting are based on Canon's testing standards (3:2 aspect ratio, ISO 100 and Standard Picture Style) using an 8 GB card. **These figures will vary depending on the subject, card brand, aspect ratio, ISO speed, Picture Style, Custom Functions, and other settings.**
- The maximum burst applies to high-speed continuous shooting. Figures in parentheses apply to an UHS-I class 16 GB card based on Canon's testing standards.

Even if you use a UHS-I class card, the maximum burst indicator will not change. The maximum burst in parentheses in the table will apply instead.

-  If you select both RAW and JPEG, the same image will be recorded simultaneously to the card in both RAW and JPEG at the image-recording qualities that were set. The two images will be recorded with the same file numbers (file extension: .JPG for JPEG and .CR2 for RAW).
- The image-recording quality icons are as follows: **RAW** (RAW), **M RAW** (Middle RAW), **S RAW** (Small RAW), JPEG,  (Fine),  (Normal), **L** (Large), **M** (Middle), **S** (Small).

RAW Images

A RAW image is raw data output by the image sensor converted to digital data. It is recorded to the card as is, and you can select the quality as follows: **RAW**, **M RAW**, or **S RAW**.

A **RAW** image can be processed with [] **1: RAW image processing** (p.390) and saved as a JPEG image. (**M RAW** and **S RAW** images cannot be processed with the camera.) As the RAW image itself does not change, you can process the RAW image to create any number of JPEG images with various processing conditions.

You can use Digital Photo Professional (EOS software, p.512) to process RAW images. You can make various adjustments to images depending upon how they will be used and generate JPEG, TIFF, or other types of images reflecting the effects of those adjustments.

RAW Image Processing Software

- To display RAW images on a computer, using Digital Photo Professional (DPP, EOS software) is recommended.
- Previous versions of DPP Ver.4.x cannot process RAW images taken with this camera. If a previous version of DPP Ver.4.x is installed on your computer, obtain and install the latest version of DPP from the Canon Web site to update it (p.512). (The previous version will be overwritten.) Note that DPP Ver.3.x or earlier cannot process RAW images taken with this camera.
- Commercially-available software may not be able to display RAW images taken with this camera. For compatibility information, contact the software manufacturer.

Maximum Burst for Continuous Shooting



The approximate maximum burst is displayed on the bottom right in the viewfinder and on the shooting function settings screen.

If the maximum burst for continuous shooting is 99 or higher, “99” will be displayed.

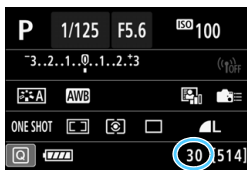

 The maximum burst is displayed even when a card is not inserted in the camera. Make sure that a card is inserted before taking a picture.

 If the maximum burst is displayed as “99”, it indicates that you can shoot 99 or more shots continuously. If the maximum burst decreases to 98 or lower and the internal buffer memory becomes full, “buSY” will be displayed in the viewfinder and on the LCD panel. Shooting will then be disabled temporarily. If you stop continuous shooting, the maximum burst will increase. After all the captured images are written to the card, you can resume continuous shooting and shoot up to the maximum burst listed in the table on page 143.

MENU Changing the Image's Aspect Ratio ☆

You can change the image's aspect ratio. [3:2] is set by default. When [4:3], [16:9], or [1:1] is set, frame lines indicating the shooting area will be displayed in the viewfinder. During Live View shooting, the image appears with the surrounding area masked in black on the LCD monitor.

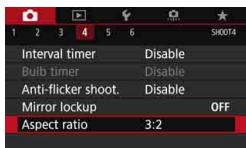

1 Select the aspect ratio.

- Under the [CAMERA] tab, select [Aspect ratio], then press <SET>.

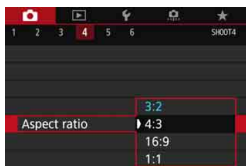

2 Set the aspect ratio.

- Select an aspect ratio, then press <SET>.

• JPEG images

The images will be saved with the set aspect ratio.

• RAW images

The images will always be saved with the [3:2] aspect ratio. The selected aspect ratio information is added to the RAW image file. When you process the RAW image with Digital Photo Professional (EOS software), this allows you to generate an image with the same aspect ratio set for shooting. In the case of the [4:3], [16:9], and [1:1] aspect ratios, the lines to indicate the aspect ratio will appear during image playback, but they are not actually drawn on the captured image.

 The [CAMERA: Aspect ratio] setting does not work with multiple exposures.

The table below shows the aspect ratio and the number of recorded pixels for each image-recording quality.

Image Quality	Aspect Ratio and Pixel Count (Approx.)			
	3:2	4:3	16:9	1:1
L	6000x4000 (24.0 megapixels)	5328x4000* (21.3 megapixels)	6000x3368* (20.2 megapixels)	4000x4000 (16.0 megapixels)
M	3984x2656 (10.6 megapixels)	3552x2664 (9.5 megapixels)	3984x2240* (8.9 megapixels)	2656x2656 (7.1 megapixels)
S1	2976x1984 (5.9 megapixels)	2656x1992 (5.3 megapixels)	2976x1680* (5.0 megapixels)	1984x1984 (3.9 megapixels)
S2	1920x1280 (2.5 megapixels)	1696x1280* (2.2 megapixels)	1920x1080 (2.1 megapixels)	1280x1280 (1.6 megapixels)
S3	720x480 (0.35 megapixels)	640x480 (0.31 megapixels)	720x408* (0.29 megapixels)	480x480 (0.23 megapixels)



- The items marked with an asterisk do not exactly match the indicated aspect ratio.
- The shooting area displayed for the asterisked aspect ratio may be slightly different from the actual shooting area. Check the captured images on the LCD monitor during shooting.
- If you use a different camera to directly print images shot with this camera in the 1:1 aspect ratio, the images may not be correctly printed.

ISO: Setting the ISO Speed for Still Photos ☆

Set the ISO speed (image sensor's sensitivity to light) to suit the ambient light level. In Basic Zone modes, the ISO speed is set automatically (p.150).

Regarding the ISO speed during movie shooting, see pages 296 and 299.

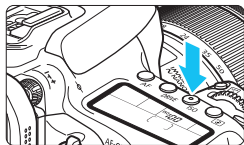

1 Press the <ISO> button (⚙️).

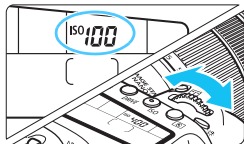

2 Set the ISO speed.

- While looking at the LCD panel or in the viewfinder, turn the <☀️> or <⌚> dial.
- ISO speed can be set within ISO 100 - ISO 16000 in 1/3-stop increments.
- “A” indicates ISO Auto. The ISO speed will be set automatically (p.150).
- When the screen shown on the left is displayed, you can press the <INFO.> button to set it to “AUTO”.

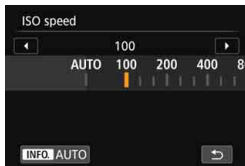

ISO Speed Guide

ISO Speed	Shooting Situation (No flash)	Flash Range
ISO 100 - ISO 400	Sunny outdoors	The higher the ISO speed, the farther the effective flash range will extend.
ISO 400 - ISO 1600	Overcast skies or evening time	
ISO 1600 - ISO 16000, H	Dark indoors or night	

* High ISO speeds will result in grainier images.



- As "H" (equivalent to ISO 25600) is an expanded ISO speed setting, noise (dots of light, banding, etc.) and irregular colors will be more noticeable, and the resolution will be lower compared with the standard setting.
- If [**3: Highlight tone priority**] is set to **[Enable]**, ISO 100/125/160 and "H" (equivalent to ISO 25600) cannot be selected (p.174).
- Shooting in high temperatures may result in images that look grainier. Long exposures can also cause irregular colors in the image.
- When you shoot at high ISO speeds, noise (such as dots of light and banding) may become noticeable.
- When shooting in conditions that produce an extreme amount of noise, such as a combination of high ISO speed, high temperature, and long exposure, images may not be recorded properly.
- If you use a high ISO speed and flash to shoot a close subject, overexposure may result.



You can expand the settable ISO speed range up to ISO 25600 (H)-equivalent with **[Range for stills]** under [**2: ISO speed settings**] (p.151).

ISO Auto

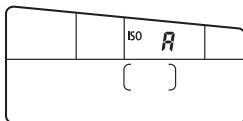

If the ISO speed is set to “A” (Auto), the actual ISO speed setting will be displayed when you press the shutter button halfway. As indicated below, the ISO speed will be set automatically to suit the shooting mode.

Shooting Mode		ISO Speed Setting	
		No Flash	With Flash
		ISO 100 - ISO 6400	ISO 400 ^{*1*2} (Except in the , , <SCN: >, <: > modes.)
SCN			
		ISO 100 - ISO 12800	
		ISO 100 - ISO 1600	
P, Tv, Av, M		ISO 100 - ISO 16000 ^{*1}	
With bulb exposures		ISO 400 ^{*1}	

*1: The actual ISO speed range depends on the [Minimum] and [Maximum] settings set in [Auto range] (p.152).

*2: (1) If fill-in flash will cause overexposure, ISO speed may be reduced, down to a possible minimum of ISO 100.

(2) In <SCN: > and <P> modes, if you use bounce flash with an external Speedlite, the ISO speed will be automatically set within ISO 400 - ISO 1600.

MENU Setting the Manually-Settable ISO Speed Range

You can set the manually-settable ISO speed range (minimum and maximum limits). You can set the minimum limit within ISO 100 to ISO 16000, and the maximum limit within ISO 200 to H (equivalent to ISO 25600).

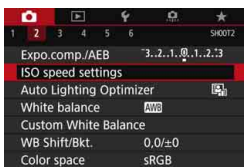

1 Select [ISO speed settings].

- Under the [M/2] tab, select [ISO speed settings], then press <SET>.

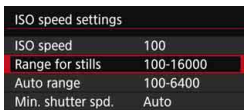

2 Select [Range for stills].



3 Set the minimum limit.

- Select the minimum limit box, then press <SET>.
- Select the ISO speed, then press <SET>.

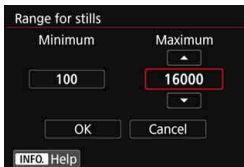

4 Set the maximum limit.

- Select the maximum limit box, then press <SET>.
- Select the ISO speed, then press <SET>.

5 Select [OK].

MENU Setting the ISO Speed Range for ISO Auto

You can set the automatic ISO speed range for ISO Auto within ISO 100 - ISO 16000. You can set the minimum limit within ISO 100 - ISO 12800, and the maximum limit within ISO 200 - ISO 16000 in 1-stop increments.

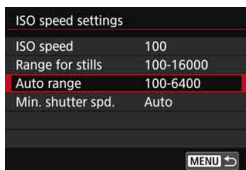
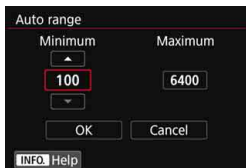
**1** Select [Auto range].**2** Set the minimum limit.

- Select the minimum limit box, then press < (SET) >.
- Select the ISO speed, then press < (SET) >.

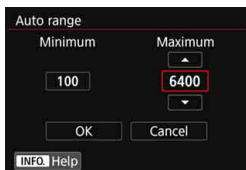
**3** Set the maximum limit.

- Select the maximum limit box, then press < (SET) >.
- Select the ISO speed, then press < (SET) >.

4 Select [OK].

The [Minimum] and [Maximum] settings will also be applied to the ISO speed safety shift's minimum and maximum ISO speeds (p.415).

MENU Setting the Minimum Shutter Speed for ISO Auto

You can set the minimum shutter speed so that the shutter speed set automatically will not be too slow when ISO Auto is set.

This is useful in the <P> and <Av> modes when you use a wide-angle lens to shoot a moving subject or when you use a telephoto lens. It helps to reduce camera shake and blurred subjects.

ISO speed settings	
ISO speed	100
Range for stills	100-16000
Auto range	100-6400
Min. shutter spd.	Auto

1 Select [Min. shutter spd.].

Automatically set

Min. shutter spd.	
Auto(Standard)	
Auto	
Manual	
Slower	Faster

2 Set the desired minimum shutter speed.

- Select [Auto] or [Manual].
- If you select [Auto], turn the < > dial to set the desired speed, slower or faster, compared to the standard speed, then press < (SET) >.
- If you select [Manual], turn the < > dial to select the shutter speed, then press < (SET) >.

Manually set

Min. shutter spd.																
Manual(1/125)																
Auto																
Manual																
<table border="1"> <tbody> <tr> <td>1/8000</td> <td>1/4000</td> <td>1/2000</td> <td>1/1000</td> <td>1/500</td> </tr> <tr> <td>1/250</td> <td>1/125</td> <td>1/60</td> <td>1/30</td> <td>1/15</td> </tr> <tr> <td>1/8</td> <td>1/4</td> <td>0.5</td> <td>1"</td> <td></td> </tr> </tbody> </table>		1/8000	1/4000	1/2000	1/1000	1/500	1/250	1/125	1/60	1/30	1/15	1/8	1/4	0.5	1"	
1/8000	1/4000	1/2000	1/1000	1/500												
1/250	1/125	1/60	1/30	1/15												
1/8	1/4	0.5	1"													





- If a correct exposure cannot be obtained with the maximum ISO speed limit set with [Auto range], a shutter speed slower than the [Min. shutter spd.] will be set to obtain a standard exposure.
- This function will not be applied to flash and movie shooting.



When [Auto: 0] is set, the minimum shutter speed will be the reciprocal of the lens focal length. A single step from [Slower] to [Faster] is equivalent to a single shutter speed stop.



Selecting a Picture Style ☆

By selecting a Picture Style, you can obtain image characteristics matching your photographic expression or the subject.

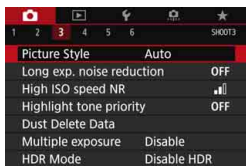
In Basic Zone modes, [] (Auto) is set automatically. (In <> modes, [] (Standard) is set.)



1 Select [Picture Style].

- Under the [ 3] tab, select [Picture Style], then press < >.



2 Select a Picture Style.

- Select a Picture Style, then press < >.
- ▶ The Picture Style will be set.

Picture Style Characteristics

Auto

The color tone will be adjusted automatically to suit the scene. The colors will look vivid for blue skies, greenery and sunsets, particularly in nature, outdoor and sunset scenes.

 If the desired color tone is not obtained with [Auto], use another Picture Style.

Standard

The image looks vivid, sharp, and crisp. This is a general-purpose Picture Style suitable for most scenes.

Portrait

For nice skin tones. The image looks softer. Suited for close-up portraits.

By changing the [Color tone] (p.157), you can adjust the skin tone.

Landscape

For vivid blues and greens, and very sharp and crisp images.
Effective for impressive landscapes.

Fine Detail

Suited for detailed outline and fine texture description of the subject.
The colors will be slightly vivid.

Neutral

This Picture Style is for users who prefer to process images with their computer. For natural colors and subdued images with modest brightness and color saturation.

Faithful

Suited for processing the image with a computer. The color of a subject that is captured in sunlight at a color temperature of 5200K will be adjusted to match the subject's colorimetric color. For subdued images with modest brightness and color saturation.

Monochrome

Creates black-and-white images.



Black-and-white images shot in JPEG cannot be turned into color. Be careful not to leave the **[Monochrome]** setting on when you want to shoot photos in color again.



You can display <  > in the viewfinder when **[Monochrome]** is set (p.425).

User Def. 1-3

You can register a basic style such as **[Portrait]**, **[Landscape]**, a Picture Style file, etc., and adjust it as desired (p.160). Any User Defined Picture Style that has not been set will have the same default settings as the **[Auto]** Picture Style.

Symbols

The Picture Style selection screen has icons for **[Strength]**, **[Fineness]**, or **[Threshold]** of **[Sharpness]**, **[Contrast]**, and other parameters. The numerals indicate the set values for these parameters set for the respective Picture Style.



Symbols

	Sharpness	
		Strength
		Fineness
	Threshold	
	Contrast	
	Saturation	
	Color tone	
	Filter effect (Monochrome)	
	Toning effect (Monochrome)	

During movie playback, “*,” “*” will be displayed for **[Fineness]** and **[Threshold]** of **[Sharpness]**. **[Fineness]** and **[Threshold]** will not be applied to movies.

Customizing a Picture Style ☆

You can customize the Picture Styles. You can change or adjust the parameter settings of Picture Styles such as **[Strength]**, **[Fineness]**, or **[Threshold]** of **[Sharpness]**, and **[Contrast]**, and other parameters from the default settings. To see the resulting effects, take test shots. To customize **[Monochrome]**, see page 159.

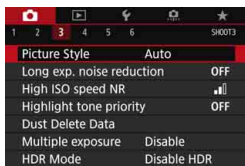



- Press the <MENU> button to save the adjusted parameters. The Picture Style selection screen will reappear.
- ▶ Any parameter settings different from the default will be displayed in blue.

Parameter Settings and Effects

	Sharpness		
①	Ⓢ Strength	0: Less sharp outline	7: Sharp outline
	Ⓣ Fineness ^{*1}	1: Fine	5: Grainy
	Ⓣ Threshold ^{*2}	1: Low	5: High
Ⓢ	Contrast	-4: Low contrast	+4: High contrast
Ⓢ	Saturation	-4: Low saturation	+4: High saturation
Ⓢ	Color tone	-4: Reddish skin tone	+4: Yellowish skin tone

*1: Indicates the fineness of the outlines to be emphasized. The smaller the number, the finer the outlines that can be emphasized.

*2: Sets how much the outline is emphasized based on the difference in contrast between the subject and the surrounding area. The smaller the number, the more the outline with low contrast difference can be emphasized. However, noise tends to be more noticeable when the number is smaller.

- During movie playback, [**Fineness**] and [**Threshold**] for [**Sharpness**] cannot be set (these menu items are not displayed).
- By selecting [**Default set.**] in step 3, you can revert the parameter settings of the respective Picture Style to their defaults.
- To shoot with the Picture Style you adjusted, first select the adjusted Picture Style, then shoot.

Monochrome Adjustment

Besides the effects described on the preceding page such as [Contrast], or [Strength], [Fineness] and [Threshold] of [Sharpness], you can also set [Filter effect] and [Toning effect].

Filter effect



With a filter effect applied to a monochrome image, you can make white clouds or green trees stand out more.

Filter	Sample Effects
N: None	Normal black-and-white image with no filter effects.
Ye: Yellow	The blue sky will look more natural, and the white clouds will look crisper.
Or: Orange	The blue sky will look slightly darker. The sunset will look more brilliant.
R: Red	The blue sky will look quite dark. Fall leaves will look crisper and brighter.
G: Green	Skin tones and lips will appear muted. Green tree leaves will look crisper and brighter.

 Increasing the [Contrast] will make the filter effect more pronounced.

Toning effect

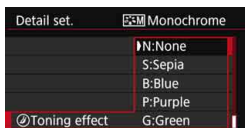

By applying a toning effect, you can create a monochrome image in the selected color. Effective when you want to create more impressive images. The following can be selected: [N:None], [S:Sepia], [B:Blue], [P:Purple], or [G:Green].

🔧 Registering a Picture Style ☆

You can select a base Picture Style such as [Portrait] or [Landscape], adjust its parameters as desired and register it under [User Def. 1], [User Def. 2], or [User Def. 3].

You can create multiple Picture Styles with different settings.

You can also adjust the parameters of a Picture Style that is registered to the camera with EOS Utility (EOS software, p.512).

1 Select [Picture Style].

- Under the [3] tab, select [Picture Style], then press <SET>.

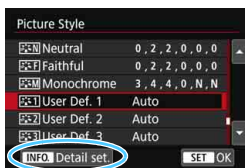

2 Select [User Def. *].

- Select [User Def. *], then press the <INFO.> button.

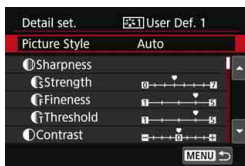

3 Press <SET>.

- With [Picture Style] selected, press <SET>.

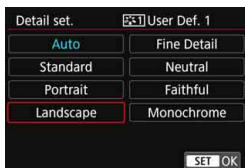

4 Select the base Picture Style.

- Select the base Picture Style, then press <SET>.
- To adjust the parameters of a Picture Style that is registered to the camera with EOS Utility (EOS software), select the Picture Style here.



5 Select a parameter.

- Select the parameter (such as **[Sharpness]** - **[Strength]**) to be set, then press **<SET>**.



6 Set the parameter.

- Adjust the parameter as desired, then press **<SET>**.
For details, see “Customizing a Picture Style” (p.157).



- Press the **<MENU>** button to register the modified Picture Style. The Picture Style selection screen will then reappear.
 - ▶ The base Picture Style will be indicated on the right of **[User Def. *]**.
 - ▶ If the settings in a Picture Style registered under **[User Def. *]** have been modified from the base Picture Style settings, the Picture Style's name will be displayed in blue.



- If a Picture Style is already registered under **[User Def. *]**, changing the base Picture Style in step 4 will clear the parameter settings of the previously registered User Defined Picture Style.
- If you perform **[Clear all camera settings]** (p.68), all the **[User Def. *]** settings will revert to their defaults. Any Picture Style registered via EOS Utility (EOS software) will have only its modified parameters reverted to the default setting.



- To shoot with the Picture Style you adjusted, select the registered **[User Def. *]**, then shoot.
- Regarding the procedure to register a Picture Style file to the camera, refer to the EOS Utility Instruction Manual.

MENU Setting the White Balance ☆

White balance (WB) is for making the white areas look white. Normally, the Auto [AWB] (Ambience priority) or [AWB w] (White priority) setting will obtain the correct white balance. If natural-looking colors cannot be obtained with Auto, you can select the white balance to match the light source or set it manually by shooting a white object.

In Basic Zone modes, [AWB] (Ambience priority) is set automatically. (In the <P> mode, [AWB w] (White priority) is set.)

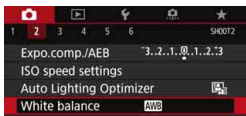

1 Select [White balance].

- Under the [CAMERA] tab, select [White balance], then press <SET>.

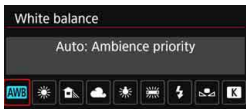

2 Select a white balance setting.

- Select the desired setting, then press <SET>.

(Approx.)

Display	Mode	Color Temperature (K: Kelvin)
[AWB]	Auto (Ambience priority, p.163)	3000-7000
[AWB w]	Auto (White priority, p.163)	
[Sun icon]	Daylight	5200
[House icon]	Shade	7000
[Cloud icon]	Cloudy, twilight, sunset	6000
[Sun with rays icon]	Tungsten light	3200
[Lightbulb icon]	White fluorescent light	4000
[Lightning bolt icon]	Flash use	Automatically set*
[Envelope icon]	Custom (p.164)	2000-10000
[K icon]	Color temperature (p.166)	2500-10000

* Applicable with Speedlites having a color temperature transmission function. Otherwise, it will be fixed to approx. 6000 K.

White Balance

To the human eye, a white object looks white regardless of the type of lighting. With a digital camera, the white for color correction basis is decided depending on the color temperature of the illumination, and then the color is adjusted with software to make the white areas look white. With this function, pictures with natural color tones can be taken.

AWB Setting the Auto White Balance

With [AWB] (Ambience priority), you can increase the intensity of the image's warm color cast when shooting a tungsten-light scene. If you select [AWBw] (White priority), you can reduce the intensity of the image's warm color cast.

If you want to match the Auto white balance of previous EOS DIGITAL camera models, select [AWB] (Ambience priority).

1 Select [White balance].

- Under the [CAM2] tab, select [White balance], then press <SET>.

2 Select [AWB].

- Select [AWB], then press the <INFO.> button.

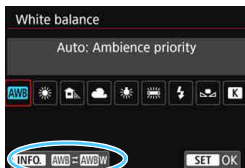

3 Select the desired item.

- Select [Auto: Ambience priority] or [Auto: White priority], then press <SET>.

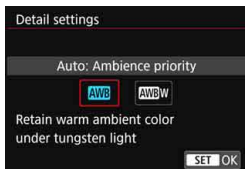

AWB : Auto: Ambience priority

AWBw : Auto: White priority

⚠ Cautions for Setting [AWB w] (White priority)

- The warm color cast of subjects may fade.
- When multiple light sources are included on the screen, the warm color cast of the picture may not be lessened.
- When using flash, the color tone will be the same as [AWB] (Ambience priority).

📷 Custom White Balance

Custom white balance enables you to manually set the white balance for a specific light source. Make sure to perform this procedure under the light source at the actual location of the shoot.



1 Shoot a white object.

- Look through the viewfinder and aim the entire dotted line box (shown in the illustration) over a plain, white object.
- Focus manually and shoot with the standard exposure set for the white object.
- You can use any white balance setting.

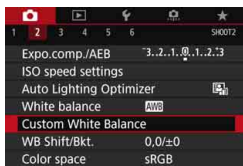

2 Select [Custom White Balance].

- Under the [📷2] tab, select [Custom White Balance], then press <SET>.
- ▶ The custom white balance selection screen will appear.



3 Import the white balance data.

- Turn the <☉> dial to select the image captured in step 1, then press <SET>.
- ▶ On the dialog screen that appears, select [OK] and the data will be imported.

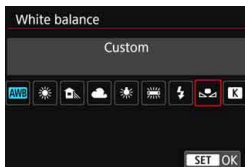

4 Select [White balance].

- Under the [CAMERA 2] tab, select [White balance], then press <SET>.

5 Select the custom white balance.

- Select [CAMERA], then press <SET>.



- If the exposure obtained in step 1 differs greatly from the standard exposure, a correct white balance may not be obtained.
- In step 3, the following images cannot be selected: Images captured with the Picture Style set to **[Monochrome]**, images shot with a Creative filter, images processed with a Creative filter after shooting, multiple-exposure images, cropped images, and images shot with another camera.



- Instead of a white object, a gray chart or 18% gray reflector (commercially-available) can produce a more accurate white balance.
- The personal white balance registered with EOS Utility (EOS software) will be registered under [CAMERA]. If you perform step 3, the data for the registered personal white balance will be erased.

K Setting the Color Temperature

You can set the white balance's color temperature numerically. This function is for advanced users.

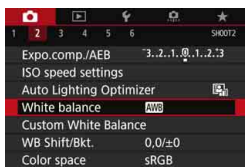

1 Select [White balance].

- Under the [📷2] tab, select [White balance], then press <SET>.

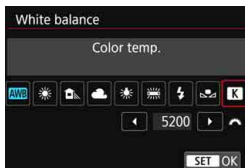

2 Set the color temperature.

- Select [K].
- Turn the <🌞> dial to set the color temperature, then press <SET>.
- The color temperature can be set from approx. 2500 K to 10000 K in 100 K increments.

- When setting the color temperature for an artificial light source, set white balance correction (magenta or green) as necessary.
- If you set [K] to the reading taken with a commercially-available color temperature meter, take test shots and adjust the setting to compensate for the difference between the color temperature meter's reading and the camera's color temperature reading.

MENU White Balance Correction ☆

You can correct the white balance that is set. This adjustment will have the same effect as using a commercially-available color temperature conversion filter or color compensating filter. Each color can be corrected to one of nine levels.

This function is for advanced users, particularly for those users who understand the use of color temperature conversion and color compensating filters and their effects.

White Balance Correction

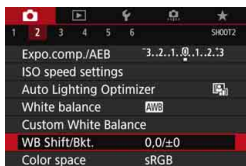

1 Select [WB Shift/Bkt.].

- Under the [CAMERA] tab, select [WB Shift/Bkt.], then press <SET>.

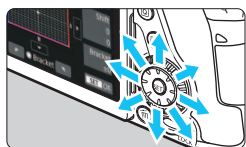

2 Set the white balance correction.

- Use <DISP> to move the "■" mark to the appropriate position.
- B is for blue, A for amber, M for magenta, and G for green. The image's color balance will be adjusted toward the color in the direction of the move.
- On the right of the screen, "Shift" indicates the direction and correction amount, respectively.
- Pressing the <RESET> button will cancel all the [WB Shift/Bkt.] settings.
- Press <SET> to exit the setting and return to the menu.

Sample setting: A2, G1

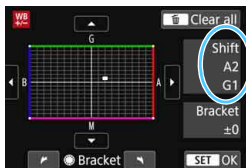

- You can display <WB> in the viewfinder when white balance correction is set (p.425).
- One level of the blue/amber correction is equivalent to approx. 5 mireds of a color temperature conversion filter. (Mired: Measuring unit indicating the density of a color temperature conversion filter.)

White Balance Auto Bracketing

With just one shot, three images with different color tones can be recorded simultaneously. Based on the color temperature of the current white balance setting, the image will be bracketed with a blue/amber bias and magenta/green bias. This function is called white balance bracketing (WB Bkt.). White balance bracketing is possible up to ± 3 levels in single-level increments.

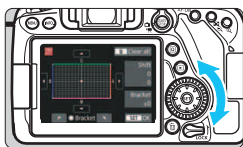

B/A bias ± 3 levels

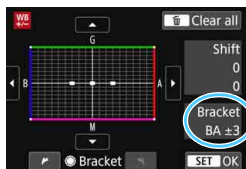

Set the white balance bracketing amount.

- In step 2 for “White Balance Correction”, when you turn the $\langle \odot \rangle$ dial, the “■” mark on the screen will change to “■■■” (3 points). Turning the dial to the right sets the B/A bracketing, and turning it to the left sets the M/G bracketing.
- ▶ On the right, “Bracket” indicates the bracketing direction and correction amount.
- Pressing the $\langle \text{trash} \rangle$ button will cancel all the [WB Shift/Bkt.] settings.
- Press $\langle \text{SET} \rangle$ to exit the setting and return to the menu.

Bracketing Sequence

The images will be bracketed in the following sequence: 1. Standard white balance, 2. Blue (B) bias, and 3. Amber (A) bias, or 1. Standard white balance, 2. Magenta (M) bias, and 3. Green (G) bias.

- During WB bracketing, the maximum burst for continuous shooting will be lower.
- Since three images are recorded for one shot, it takes longer to record the image on the card.

- You can also set white balance correction and AEB together with white balance bracketing. If you set AEB in combination with white balance bracketing, a total of nine images will be recorded for a single shot.
- You can change the number of shots for white balance bracketing (p.414).
- “Bkt.” stands for bracketing.

MENU Auto Correction of Brightness and Contrast ☆

If the image comes out dark or the contrast is low, the brightness and contrast can be corrected automatically. This function is called Auto Lighting Optimizer. The default setting is [Standard]. With JPEG images, the correction is applied when the image is captured.

In Basic Zone modes, [Standard] is set automatically.

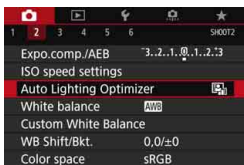

1 Select [Auto Lighting Optimizer].

- Under the [CAMERA] tab, select [Auto Lighting Optimizer], then press <SET>.



2 Select the setting.

- Select the desired setting, then press <SET>.

3 Take the picture.

- The image will be recorded with the brightness and contrast corrected if necessary.



- Depending on the shooting conditions, noise may increase.
- If a setting other than [Disable] is set and you use exposure compensation or flash exposure compensation to darken the exposure, the image may still come out bright. If you want a darker exposure, set this function to [Disable].
- If HDR mode (p.207), highlight tone priority (p.174), or multiple-exposure shooting (p.212) is set, the Auto Lighting Optimizer will be set automatically to [Disable].



In step 2, if you press the <INFO.> button and uncheck [✓] the [Disabled in M or B modes] setting, the [Auto Lighting Optimizer] can also be set in the <M> and modes.

MENU Setting Noise Reduction ☆

High ISO Speed Noise Reduction

This function reduces the noise generated in the image. Although noise reduction is applied at all ISO speeds, it is particularly effective at high ISO speeds. When shooting at low ISO speeds, the noise in the darker parts of the image (shadow areas) can further be reduced.

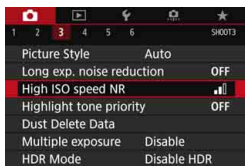

1 Select [High ISO speed NR].

- Under the [**3**] tab, select [**High ISO speed NR**], then press < **SET** >.



2 Set the level.

- Select the desired noise reduction level, then press < **SET** >.

• **NR**: Multi Shot Noise Reduction

This applies noise reduction with higher image quality than [**High**].

For a single photo, four shots are taken continuously and aligned and merged automatically into a single JPEG image.

If the image-recording quality is set to RAW or RAW+JPEG, you cannot set [**Multi Shot Noise Reduction**].

3 Take the picture.

- The image will be recorded with noise reduction applied.

 When Multi Shot Noise Reduction is set, you can display < **!** > in the viewfinder (p.425).



Cautions for Setting Multi Shot Noise Reduction

- If there is significant misalignment in the image due to camera shake, the noise reduction effect may become smaller.
- If you are handholding the camera, keep it steady to prevent camera shake. Using a tripod is recommended.
- If you shoot a moving subject, the moving subject may leave afterimages.
- The image alignment may not function properly with repetitive patterns (lattice, stripes, etc.) or flat, single-tone images.
- If the subject's brightness changes as the four consecutive shots are taken, irregular exposure in the image may result.
- After shooting, it may take some time to record an image to the card for noise reduction and merging the images. During the processing of the images, "buSY" will be displayed in the viewfinder and on the LCD panel, and you cannot take another picture until the processing is completed.
- You cannot use AEB and WB bracketing.
- If [**3: Long exp. noise reduction**], [**3: Multiple exposure**], [**3: HDR Mode**], AEB, or WB bracketing is set, [**Multi Shot Noise Reduction**] cannot be set.
- You cannot set [**Multi Shot Noise Reduction**] for bulb exposures or movie shooting.
- Flash shooting is not possible. The AF-assist beam will be emitted according to the [**. C.Fn II -6: AF-assist beam firing**] setting.
- If you turn off the power, change the shooting mode to a Basic Zone mode or , or switch to movie shooting, the setting will automatically switch to [**Standard**].

Long Exposure Noise Reduction

Noise reduction is possible with images exposed for 1 sec. or longer.

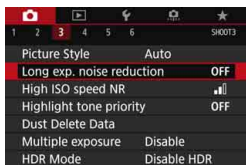

1 Select [Long exp. noise reduction].

- Under the [**3**] tab, select [**Long exp. noise reduction**], then press < (SET) >.

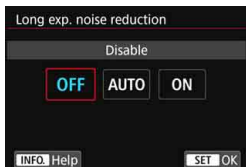

2 Set the desired setting.

- Select the desired setting, then press < (SET) >.

• Auto

For exposures of 1 sec. or longer, noise reduction is performed automatically if noise typical of long exposures is detected. This [**Auto**] setting is effective in most cases.

• Enable

Noise reduction is performed for all exposures of 1 sec. or longer. The [**Enable**] setting may reduce noise that cannot be detected with the [**Auto**] setting.

3 Take the picture.

- The image will be recorded with noise reduction applied.



- With **[Auto]** and **[Enable]**, the noise reduction process after the picture is taken may take the same amount of time as that for the exposure. You cannot take another picture until the noise reduction process is completed.
- Images taken at ISO 1600 or higher may look grainier with the **[Enable]** setting than with the **[Disable]** or **[Auto]** setting.
- With **[Enable]**, if a long exposure is shot with the Live View image displayed, **"BUSY"** will be displayed during the noise reduction process. The Live View display will not appear until the noise reduction is completed. (You cannot take another picture.)

MENU Highlight Tone Priority ☆

You can reduce overexposed, clipped highlights.



1 Select [Highlight tone priority].

- Under the [**3**] tab, select **[Highlight tone priority]**, then press **< (SET) >**.

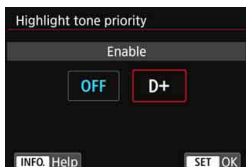

2 Select [Enable].

- Highlight details are improved. The dynamic range is expanded from the standard 18% gray to bright highlights. The gradation between the grays and highlights becomes smoother.

3 Take the picture.

- The image will be recorded with highlight tone priority applied.

- When **[Enable]** is set, noise may increase slightly.
- With **[Enable]**, the settable ISO speed range will be ISO 200 or higher. Expanded ISO speed cannot be set.

If highlight tone priority is set, **<D+>** is displayed in the viewfinder and on the LCD panel.

MENU Correction of Lens Peripheral Illumination and Aberrations ☆

Peripheral light fall-off is a phenomenon that makes the image corners look darker due to the lens characteristics. Color fringing along subject outlines is called chromatic aberration. And image distortion due to lens characteristics is called distortion. These lens aberrations and light falloff can be corrected. By default, Peripheral illumination and Chromatic aberration correction are set to **[Enable]**, and Distortion correction is set to **[Disable]**.

If  **Correction data not available** is displayed, see “Lens Correction Data” on page 177.

Peripheral Illumination Correction

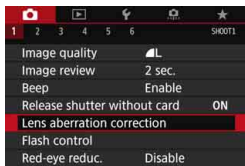

1 Select **[Lens aberration correction]**.

- Under the [ 1] tab, select **[Lens aberration correction]**, then press **<SET>**.

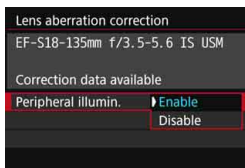



2 Select the setting.

- Check that **[Correction data available]** is displayed for the attached lens.
- Select **[Peripheral illumin.]**, then press **<SET>**.
- Select **[Enable]**, then press **<SET>**.

3 Take the picture.

- The image will be recorded with the peripheral illumination corrected.

 Depending on shooting conditions, noise may appear on the image periphery.

-  ● The correction amount applied will be lower than the maximum correction amount that can be applied with Digital Photo Professional (EOS software, p.512).
- The higher the ISO speed, the lower the correction amount will be.
- In Basic Zone modes, the peripheral illumination correction and chromatic aberration correction will be applied automatically. Distortion correction will not be applied.

Chromatic Aberration Correction

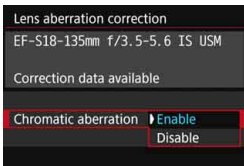

1 Select the setting.

- Check that [**Correction data available**] is displayed for the attached lens.
- Select [**Chromatic aberration**], then press <SET>.
- Select [**Enable**], then press <SET>.

2 Take the picture.

- The image will be recorded with the chromatic aberration corrected.

Distortion Correction

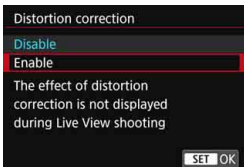

1 Select the setting.

- Check that [**Correction data available**] is displayed for the attached lens.
- Select [**Distortion correction**], then press <SET>.
- Select [**Enable**], then press <SET>.

2 Take the picture.

- The image will be recorded with the distortion corrected.



- When distortion correction is enabled, the camera records an image range narrower than the one seen through the viewfinder. (Image periphery will be slightly trimmed and resolution slightly lowered.)
- Distortion correction will be reflected in the captured image, but not in the viewfinder or Live View image during shooting.
- If you set [**Distortion correction**] to [**Enable**], the maximum burst (p.145) during continuous shooting will decrease.
- Distortion will not be corrected if you shoot a movie or set the HDR mode, multiple exposures, or Multi Shot Noise Reduction.
- Using distortion correction during Live View shooting will slightly affect the angle of view.
- AF point display information (p.352) and Dust Delete Data (p.405) will not be appended to images recorded with distortion correction applied.

Lens Correction Data

The camera already contains data for lens peripheral illumination correction, chromatic aberration correction, and distortion correction for approx. 30 lenses. If you select [**Enable**], the peripheral illumination correction, chromatic aberration correction, and distortion correction will be applied automatically for any lens whose correction data is registered in the camera.

With EOS Utility (EOS software), you can check which lenses have their correction data registered in the camera. You can also register the correction data for unregistered lenses. For details, refer to the EOS Utility Instruction Manual.

For lenses incorporating the correction data, it is not necessary to register the correction data to the camera.

Cautions for Lens Correction

- Peripheral illumination correction, chromatic aberration correction, and distortion correction cannot be applied to JPEG images already taken.
- When using a non-Canon lens, setting the corrections to **[Disable]** is recommended, even if **[Correction data available]** is displayed.
- If you use the magnified view during Live View shooting, the peripheral illumination correction will not be reflected in the image displayed on the screen.
- The correction amount will be less if the lens used does not have distance information.

Notes for Lens Correction

- If the effect of the correction is not visible, magnify the image after shooting and check it again.
- Corrections can be applied even when an Extender or Life-size Converter is attached.
- If the correction data for the attached lens is not registered to the camera, the result will be the same as when the correction is set to **[Disable]**.

MENU Reducing Flicker ☆

If you shoot an image with a fast shutter speed under a light source such as fluorescent light, the blinking of the light source causes flicker and the image may be vertically unevenly exposed. If continuous shooting is used under these conditions, uneven exposures or colors across the images may result. When you use this feature during viewfinder shooting, the camera detects the frequency of the light source's blinking and takes the picture when the flicker causes less effect on exposure or color tone.

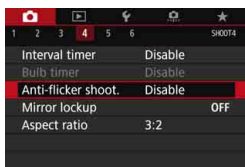

1 Select [Anti-flicker shoot.].

- Under the [**4**] tab, select [**Anti-flicker shoot.**], then press <SET>.

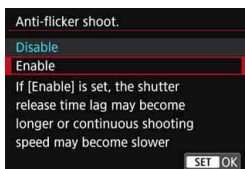

2 Select [Enable].

3 Take the picture.

- The image will be taken with reduced unevenness of exposure or color tone caused by the flicker.

- When [**Enable**] is set and you shoot under a flickering light source, the shutter-release time lag may become longer. Also, the continuous shooting speed may become slower, and the shooting interval may become irregular.
- This function does not work with Live View shooting or movie shooting.
- In the <**P**> or <**Av**> mode, if the shutter speed changes during continuous shooting or if you shoot multiple shots of the same scene at different shutter speeds, the color tone may be inconsistent. To avoid inconsistent color tones, use the <**Tv**> or <**M**> mode at a fixed shutter speed.
- The color tone of images shot when [**Anti-flicker shoot.**] is set to [**Enable**] may look different from when [**Disable**] is set.
- Flicker at a frequency other than 100 Hz or 120 Hz cannot be detected. Also, if the flickering frequency of the light source changes during continuous shooting, effects of the flicker cannot be reduced.

- ❗
- If the subject is against a dark background or if there is a bright light in the image, flicker may not be properly detected.
- Under certain special types of lighting, the camera may not be able to reduce the effects of the flicker even when < **Flicker!** > is displayed in the viewfinder.
- Depending on the light source, flicker may not be detected properly.
- If you recompose a shot, < **Flicker!** > may appear and disappear intermittently.
- Depending on the light sources or shooting conditions, expected result may not be obtained even if you use this function.

- ☰
- Taking test shots in advance is recommended.
- If < **Flicker!** > is not displayed in the viewfinder, under [**2: Viewfinder display**], set [**Flicker detection**] to [**Show**] (p.74). When the camera reduces the effects of the flicker when you shoot, < **Flicker!** > will light up. Under a light source which does not flicker, or if no flicker is detected, < **Flicker!** > will not be displayed.
- If [**Flicker detection**] is set to [**Show**] and [**Anti-flicker shoot.**] is set to [**Disable**], metering under a flickering light source will cause < **Flicker!** > to blink in the viewfinder as a warning. Setting [**Enable**] before shooting is recommended.
- In Basic Zone modes, < **Flicker!** > will not be displayed, but the effects of flicker will be reduced when you shoot.
- Anti-flicker shooting also works with flash. However, the expected result may not be obtained during wireless flash shooting.

MENU Setting the Color Space ☆

The range of reproducible colors is called “color space”. With this camera, you can set the color space for captured images to sRGB or Adobe RGB. For normal shooting, sRGB is recommended. In Basic Zone modes, sRGB is set automatically.

1 Select [Color space].

- Under the [CAMERA 2] tab, select [Color space], then press <SET>.

2 Set the desired color space.

- Select [sRGB] or [Adobe RGB], then press <SET>.

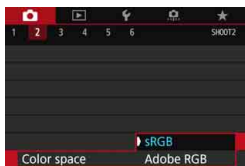

Adobe RGB

This color space is mainly used for commercial printing and other industrial uses. This setting is not recommended if you are not familiar with image processing, Adobe RGB, and Design rule for Camera File System 2.0 (Exif 2.21 or higher). The image will look very subdued in a sRGB computer environment and with printers not compliant to Design rule for Camera File System 2.0 (Exif 2.21 or higher). Post-processing of the image with computer software will therefore be required.



- If the captured still photo was shot in the Adobe RGB color space, the first character in the file name will be an underscore “_”.
- The ICC profile is not appended. For explanations about the ICC profile, refer to the Digital Photo Professional Instruction Manual.

MENU Creating and Selecting a Folder

You can freely create and select the folder where the captured images are to be saved.

This operation is optional since a folder will be created automatically for saving captured images.

Creating a Folder

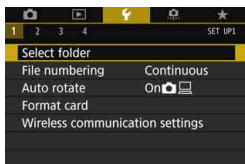

- 1 **Select [Select folder].**
 - Under the [**1**] tab, select [**Select folder**], then press **<SET>**.

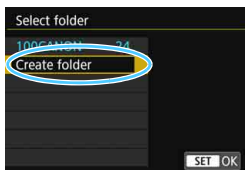

- 2 **Select [Create folder].**

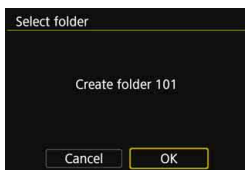

- 3 **Select [OK].**
 - ▶ A new folder with the folder number increased by one is created.

Selecting a Folder



- Select a folder on the folder selection screen, then press < **SET** >.
- ▶ The folder where the captured images will be saved is selected.
- Subsequent captured images will be recorded into the selected folder.



Folders

As with “100CANON” for example, the folder name starts with three digits (the folder number) followed by five alphanumeric characters. A folder can contain up to 9999 images (file number 0001 - 9999). When a folder becomes full, a new folder with the folder number increased by one is created automatically. Also, if manual reset (p.185) is executed, a new folder will be created automatically. Folders numbered from 100 to 999 can be created.

Creating Folders with a Computer

With the card open on the screen, create a new folder named “DCIM”. Open the DCIM folder and create as many folders as necessary to save and organize your images. The folder name must follow the format “100ABC_D”. The first three digits are the folder number, from 100 to 999. The last five characters can be any combination of upper- and lower-case letters from A to Z, numerals, and the underscore “_”. The space cannot be used. Also note that two folder names cannot share the same three-digit folder number (for example, “100ABC_D” and “100W_XYZ”), even if the last five characters in each name are different.

MENU File Numbering Methods

The image files will be numbered from 0001 to 9999 in the order the images are taken, then saved in a folder. You can change how the file number is assigned.

(Example) **IMG_0001.JPG**

File number

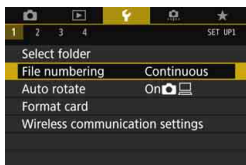

1 Select [File numbering].

- Under the [**1**] tab, select [**File numbering**], then press **<SET>**.

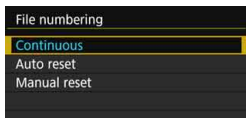

2 Select the file numbering method.

- Select the desired setting, then press **<SET>**.

Continuous

Continues the file numbering sequence even after the card is replaced or a new folder is created.

Even after you replace the card or create a new folder, the file numbering continues in sequence up to 9999. This is useful when you want to save images numbered anywhere between 0001 to 9999 on multiple cards or in multiple folders into one folder on a computer. If the replacement card or existing folder already contains images recorded previously, the file numbering of the new images may continue from the file numbering of the existing images on the card or in the folder. If you want to use continuous file numbering, it is recommended that you use a newly formatted card each time.

File numbering after replacing the card

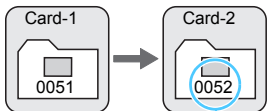

Next sequential file number

File numbering after creating a folder

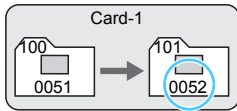

Auto Reset

Restarts the file numbering from 0001 each time the card is replaced or a new folder is created.

When you replace the card or create a folder, the file numbering restarts from 0001 for the new images saved. This is useful if you want to organize images by cards or folders.

If the replacement card or existing folder already contains images recorded previously, the file numbering of the new images may continue from the file numbering of the existing images on the card or in the folder. If you want to save images with the file numbering starting from 0001, use a newly formatted card each time.

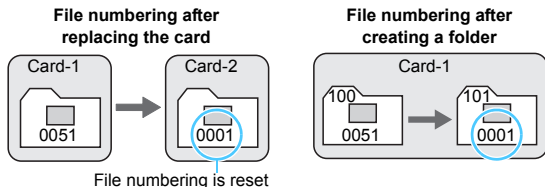

Manual Reset

Resets the file numbering to 0001 or to start from file number 0001 in a new folder.

When you reset the file numbering manually, a new folder is created automatically and the file numbering of images saved to that folder starts from 0001.

This is useful, for example, when you want to use different folders for the images taken yesterday and the ones taken today.

⚠ If the file number in folder 999 reaches 9999, shooting will not be possible even if the card still has storage capacity. The LCD monitor will display a message telling you to replace the card. Replace it with a new card.

📁 For both JPEG and RAW images, the file name will start with "IMG_". Movie file names will start with "MVI_". The extension will be ".JPG" for JPEG images, ".CR2" for RAW images, and ".MOV" or ".MP4" for movies.

MENU Setting Copyright Information ☆

When you set the copyright information, it will be recorded to the image as Exif information.

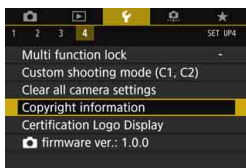

1 Select [Copyright information].

- Under the [**4**] tab, select [**Copyright information**], then press <SET>.



2 Select the option to be set.

- Select [**Enter author's name**] or [**Enter copyright details**], then press <SET>.



3 Enter text.

- Press the <Q> button to toggle between the top and bottom entry areas.
- Press the <▲> <▼> or <◀> <▶> keys to move the □ frame and select the desired character. Then press <SET> to enter it.
- By selecting [**Aa=1@**] and pressing <SET>, you can change the input mode.
- You can enter up to 63 characters.
- To delete a character, press the <🗑> button.
- To cancel the text entry, press the <INFO.> button, then select [**OK**].

4 Exit the setting.

- After entering the text, press the <MENU> button, then select [OK].
- ▶ The information will be saved and the screen will return to step 2.

Checking the Copyright Information

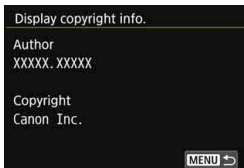

When you select [**Display copyright info.**] in step 2, you can check the [**Author**] and [**Copyright**] information that you entered.



If the entry for “Author” or “Copyright” is long, it may not be displayed entirely when you select [**Display copyright info.**].

Deleting the Copyright Information

When you select [**Delete copyright information**] in step 2, you can delete the [**Author**] and [**Copyright**] information.



You can also set or check the copyright information with EOS Utility (EOS software, p.512).

5

Advanced Operations

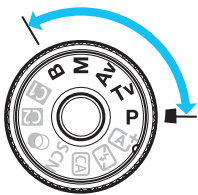

In Creative Zone modes, you can change various settings of the camera as you desire to obtain a wide variety of shooting results, by selecting the shutter speed and/or aperture, adjusting the exposure as you prefer, etc.

- The ☆ icon at the upper right of the page title indicates that the function is available only in Creative Zone modes (**P/Tv/Av/M/B**).
- After you press the shutter button halfway and let go, the exposure settings will remain displayed in the viewfinder and on the LCD panel for approx. 4 sec. (ⓘ4) by the metering timer function.
- For the functions settable in each shooting mode, see page 460.



Set the <LOCK> switch downward.

P: Program AE

The camera automatically sets the shutter speed and aperture to suit the subject's brightness. This is called Program AE.

* <P> stands for Program.

* AE stands for Auto Exposure.



1 Set the Mode Dial to <P>.



2 Focus on the subject.

- Look through the viewfinder and aim the AF point over the subject. Then press the shutter button halfway.
- ▶ When focus is achieved, the focus indicator <●> on the viewfinder's bottom right will light up (when in One-Shot AF mode).
- ▶ The shutter speed and aperture will be set automatically and displayed in the viewfinder and on the LCD panel.



3 Check the display.

- The standard exposure will be obtained as long as the shutter speed and aperture display do not blink.

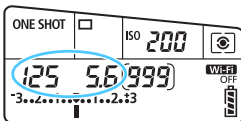

4 Take the picture.

- Compose the shot and press the shutter button completely.



- If the “30” shutter speed and the lowest f/number blink, it indicates underexposure. Increase the ISO speed or use flash.





- If the “8000” shutter speed and the highest f/number blink, it indicates overexposure. Lower the ISO speed or use an ND filter (sold separately) to reduce the amount of light entering the lens.



Differences Between <P> and <A+> Modes

In the <A+> mode, many functions, such as the AF operation and metering mode, are set automatically to prevent spoiled shots. The functions you can set are limited. With <P> mode, only the shutter speed and aperture are set automatically. You can freely set the AF operation, metering mode, and other functions (p.460).

Program Shift

- In the Program AE mode, you can freely change the shutter speed and aperture combination (Program) set automatically by the camera while maintaining the same exposure. This is called Program shift.
- To shift the program, press the shutter button halfway, then turn the  dial until the desired shutter speed or aperture is displayed.
- Program shift will be canceled automatically when the metering timer () ends (exposure setting display turns off).
- Program shift cannot be used with flash.

Tv: Shutter-Priority AE

In this mode, you set the shutter speed and the camera automatically sets the aperture to obtain the standard exposure matching the brightness of the subject. This is called shutter-priority AE. A faster shutter speed can freeze the action of a moving subject. A slower shutter speed can create a blurred effect, giving the impression of motion.

* <Tv> stands for Time value.



Blurred motion
(Slow shutter speed: 1/30 sec.)



Frozen motion
(Fast shutter speed: 1/2000 sec.)



1 Set the Mode Dial to <Tv>.

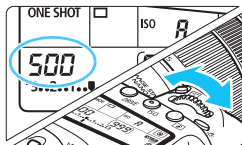

2 Set the desired shutter speed.

- While looking at the LCD panel, turn the <⚙> dial.

3 Focus on the subject.

- Press the shutter button halfway.
- ▶ The aperture is set automatically.



4 Check the viewfinder display and shoot.

- As long as the aperture is not blinking, the standard exposure will be obtained.



- If the lowest f/number blinks, it indicates underexposure. Turn the dial to set a slower shutter speed until the aperture stops blinking or set a higher ISO speed.



- If the highest f/number blinks, it indicates overexposure. Turn the dial to set a faster shutter speed until the aperture stops blinking or set a lower ISO speed.



Shutter Speed Display

The shutter speeds from “8000” to “4” indicate the denominator of the fractional shutter speed. For example, “125” indicates 1/125 sec., “0”5” indicates 0.5 sec. and “15” is 15 sec.

Av : Aperture-Priority AE

In this mode, you set the desired aperture and the camera sets the shutter speed automatically to obtain the standard exposure matching the subject brightness. This is called aperture-priority AE. A higher f/number (smaller aperture hole) will make more of the foreground and background fall within acceptable focus. On the other hand, a lower f/number (larger aperture hole) will make less of the foreground and background fall within acceptable focus.

* <Av> stands for Aperture value (aperture opening).



Blurred background
(With a low aperture f/number: f/5.6)



Sharp foreground and background
(With a high aperture f/number: f/32)



1 Set the Mode Dial to <Av>.

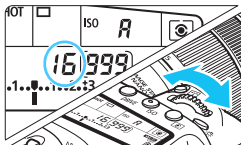

2 Set the desired aperture.

- While looking at the LCD panel, turn the <⚙> dial.

3 Focus on the subject.

- Press the shutter button halfway.
- ▶ The shutter speed is set automatically.



4 Check the viewfinder display and shoot.

- As long as the shutter speed is not blinking, the standard exposure will be obtained.



- If the “30” shutter speed blinks, it indicates underexposure. Turn the dial to set a faster aperture (lower f/number) until the shutter speed blinking stops or set a higher ISO speed.



- If the “8000” shutter speed blinks, it indicates overexposure. Turn the dial to set a slower aperture (higher f/number) until the shutter speed blinking stops or set a lower ISO speed.



Aperture Value Display

The higher the f/number, the smaller the aperture opening will be. The f/number displayed will differ depending on the lens. If no lens is attached to the camera, “00” will be displayed for the aperture.

Depth-of-Field Preview ☆

The aperture opening (diaphragm) changes only at the moment when the picture is taken. Otherwise, the aperture remains fully open. Therefore, when you look at the scene through the viewfinder or on the LCD monitor, the depth of field will look narrow.

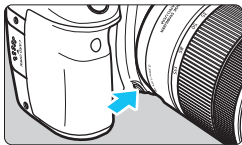

Press the depth-of-field preview button to stop down the lens to the current aperture setting, and check the depth of field (range of acceptable focus).



- A higher f/number will make more of the foreground and background fall within acceptable focus. However, the viewfinder will look darker.
- The depth-of-field effect can be clearly seen on the Live View image as you change the aperture and press the depth-of-field preview button (p.256).
- The exposure will be locked (AE lock) while the depth-of-field preview button is being pressed.

M: Manual Exposure

In this mode, you set both the shutter speed and aperture as desired. To determine the exposure, refer to the exposure level indicator in the viewfinder or use a commercially-available exposure meter. This method is called manual exposure.

* <M> stands for Manual.



1 Set the Mode Dial to <M>.

2 Set the ISO speed (p.148).

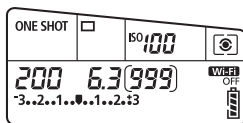

3 Set the shutter speed and aperture.

- To set the shutter speed, turn the <☀> dial.
- To set the aperture, turn the <⊙> dial.
- If it cannot be set, set the <LOCK> switch downward, then turn the <☀> or <⊙> dial.

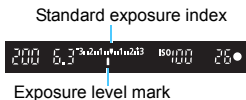

4 Focus on the subject.

- Press the shutter button halfway.
- ▶ The exposure setting will be displayed in the viewfinder and on the LCD panel.
- Check the exposure level mark <▲> to see how far the current exposure level is from the standard exposure level.

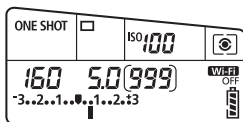

5 Set the exposure and take the picture.

- Check the exposure level indicator and set the desired shutter speed and aperture.
- If the exposure level exceeds ± 3 stops from the standard exposure, the end of the exposure level indicator will display <◀> or <▶>.

Exposure Compensation with ISO Auto

If the ISO speed is set to **A** (AUTO) for manual exposure shooting, you can set exposure compensation (p.200) as follows:

- [2: Expo.comp./AEB]
- Under [.C.Fn III-4: Custom Controls] with [**SET**: Expo comp (hold btn, turn)] (p.438).
- Quick Control (p.56)





- If ISO Auto is set, the ISO speed setting will change to suit the shutter speed and aperture in order to obtain a standard exposure. Therefore, you may not obtain the desired exposure effect. In such a case, set the exposure compensation.
- If flash is used when ISO Auto is set, exposure compensation will not be applied even if an exposure compensation amount is set.



- Under [2: Auto Lighting Optimizer], if the checkmark [] for [**Disabled in M or B modes**] is removed, Auto Lighting Optimizer can be set even in the <M> mode (p.169).
- When ISO Auto is set, you can press the <✳> button to lock the ISO speed.
- If you press the <✳> button and recompose the shot, you can see the exposure level difference on the exposure level indicator compared with when the <✳> button was pressed.
- If exposure compensation (p.200) was applied in <P>, <Tv>, or <Av> mode, and then the shooting mode is switched to <M> with ISO Auto set, the exposure compensation amount already set will still be maintained.
- With ISO Auto set and [.C.Fn I-1: Exposure level increments] set to [**1: 1/2-stop**], 1/2-stop exposure compensation will be applied with the ISO speed (1/3 stop) and shutter speed. However, the shutter speed displayed will not change.



Selecting the Metering Mode ☆





You can select one of four methods to measure the subject brightness. In Basic Zone modes, evaluative metering is set automatically. (In the <SCN: > and <C: > modes, center-weighted average metering is set.)



1 Press the <> button (6).

2 Select the metering mode.

- While looking at the LCD panel, turn the < > or < > dial.

- : Evaluative metering
- : Partial metering
- : Spot metering
- : Center-weighted average metering

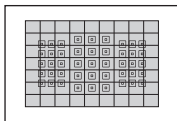
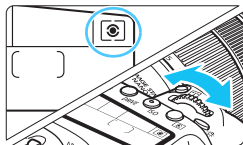

Evaluative metering

General-purpose metering mode suited even for backlit subjects. The camera adjusts the exposure automatically to suit the scene.

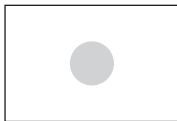

Partial metering

Effective where there are much brighter lights around the subject due to backlight, etc. Partial metering covers approx. 6.0% of the viewfinder area at the center.



Spot metering





Effective when metering a specific part of the subject or scene. Spot metering covers approx. 3.8% of the viewfinder area at the center.



 **Center-weighted average metering**

The metering is averaged for the entire scene with the viewfinder center weighted more heavily.



With  (Evaluative metering), the exposure setting will be locked when you press the shutter button halfway and focus is achieved. In the  (Partial metering),  (Spot metering), and  (Center-weighted average metering) modes, the exposure is set at the moment the picture is taken. (Pressing the shutter button halfway does not lock the exposure.)

☑ Setting Exposure Compensation ☆

Exposure compensation can brighten (increased exposure) or darken (decreased exposure) the standard exposure set by the camera.

Exposure compensation can be set in the <P>, <Tv>, and <Av> shooting modes. Although you can set the exposure compensation up to ± 5 stops* in 1/3-stop increments, the exposure compensation indicator in the viewfinder and on the LCD panel can only display the setting up to ± 3 stops. If you want to set the exposure compensation setting beyond ± 3 stops, use the Quick Control (p.56) or follow the instructions for [☑2: Expo.comp./AEB] on the next page. If the <M> mode and the ISO Auto are both set, see page 197 to set the exposure compensation.

* During Live View shooting, exposure compensation can be set up to ± 3 stops.

1 Check the exposure.

- Press the shutter button halfway (ⓘ4) and check the exposure level indicator.

Increased exposure
for a brighter image



2 Set the exposure compensation amount.

- While looking in the viewfinder or at the LCD panel, turn the <☉> dial.
- If it cannot be set, set the <LOCK> switch downward, then turn the <☉> dial.
- ▶ If you set exposure compensation, <☑> will be displayed in the viewfinder and on the LCD panel.

Decreased exposure
for a darker image



3 Take the picture.

- To cancel the exposure compensation, set the exposure compensation amount back to <☿>.

ⓘ If [☑2: Auto Lighting Optimizer] (p.169) is set to any setting other than [Disable], the image may still look bright even if a decreased exposure compensation for a darker image is set.

- The exposure compensation amount will remain in effect even after you set the power switch to <OFF>.
- After setting the exposure compensation amount, you can prevent the exposure compensation amount from changing accidentally by setting the <LOCK> switch upward.
- If the exposure compensation amount exceeds ± 3 stops, the end of the exposure level indicator will display <◀> or <▶>.

Auto Exposure Bracketing (AEB) ☆

By changing the shutter speed or aperture automatically, the camera brackets the exposure up to ± 3 stops in 1/3-stop increments for three successive shots. This is called AEB.

* AEB stands for Auto Exposure Bracketing.

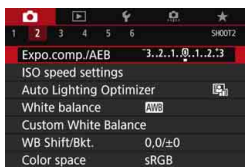

1 Select [Expo.comp./AEB].

- Under the [CAMERA] tab, select [Expo.comp./AEB], then press <SET>.

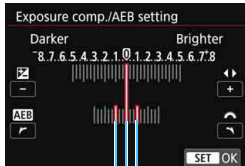

AEB range

2 Set the AEB range.

- Turn the <DIAL> dial to set the AEB range. Press the <◀> <▶> keys to set the exposure compensation amount.
- Press <SET> to set it.
- When you exit the menu, the AEB range will be displayed on the LCD panel.

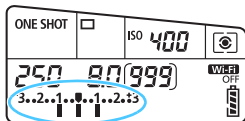

3 Take the picture.

- Three bracketed shots will be taken according to the drive mode set in this sequence: Standard exposure, decreased exposure, and increased exposure.
- AEB will not be automatically canceled. To cancel AEB, follow step 2 to turn off the AEB range display.



- During AEB, <✳> in the viewfinder and AEB range will blink.
- If the drive mode is set to <□> or <□S>, press the shutter button three times for each shot. When <□H>, <□>, or <□S> is set and you hold down the shutter button completely, the three bracketed shots will be taken continuously and the camera will automatically stop shooting. When <☺> or <☺₂> is set, the three bracketed shots will be taken continuously after a 10-sec. or 2-sec. delay.
- You can set AEB in combination with exposure compensation.
- If the AEB range exceeds ±3 stops, the end of the exposure level indicator will display <◀> or <▶>.
- AEB cannot be used with flash, bulb exposures, or when **[Multi Shot Noise Reduction]**, **[HDR Mode]**, or a Creative filter is set.
- AEB will be canceled automatically when you set the power switch to <OFF> or when the flash is ready to fire.

✳ AE Lock ☆

You can lock the exposure when the area of focus is to be different from the exposure metering area or when you want to take multiple shots at the same exposure setting. Press the <✳> button to lock the exposure, then recompose and take the picture. This is called AE lock. It is effective for shooting backlit subjects, etc.

1 Focus on the subject.

- Press the shutter button halfway.
- ▶ The exposure setting will be displayed.

2 Press the <✳> button (ⓘ4).

- ▶ The <✳> icon lights up in the viewfinder to indicate that the exposure setting is locked (AE lock).
- Each time you press the <✳> button, the current exposure setting is locked.





3 Recompose and take the picture.

- If you want to take more pictures while maintaining the AE lock, keep holding down the <✳> button and press the shutter button to take another picture.



AE Lock Effects

Metering Mode (p.198)	AF Point Selection (p.120-122)	
	Automatic Selection	Manual Selection
 *	AE lock is applied at the AF point that achieved focus.	AE lock is applied at the selected AF point.
	AE lock is applied to the center AF point.	

* When the lens's focus mode switch is set to <MF>, AE lock is applied to the center AF point.

 AE lock is not possible with bulb exposures.

B: Bulb Exposures

In this mode, the shutter stays open as long as you hold down the shutter button completely, and closes when you let go of the shutter button. This is called bulb exposure. Use bulb exposures for night scenes, fireworks, the heavens, and other subjects requiring long exposures.



1 Set the Mode Dial to .

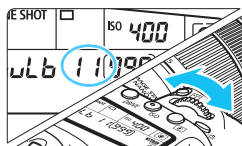

2 Set the desired aperture.

- While looking at the LCD panel, turn the <☀> or <☾> dial.

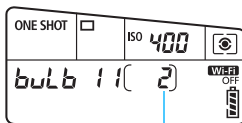

Elapsed exposure time

3 Take the picture.

- The exposure will continue for as long as you keep the shutter button pressed completely.
- ▶ The elapsed exposure time will be displayed on the LCD panel.

- ⚠ Do not point the camera toward an intense light source, such as the sun or an intense artificial light source. Doing so may damage the image sensor or the camera's internal components.
- Long exposures produce more noise than usual.
- If ISO Auto is set, the ISO speed will be ISO 400 (p.150).
- For a bulb exposure, if you use both the self-timer and mirror lockup instead of the bulb timer, keep pressing the shutter button completely (self-timer delay time + bulb exposure time). If you let go of the shutter button during the self-timer countdown, there will be a shutter-release sound, but no picture will be taken. If you use the bulb timer under the same shooting conditions, you need not keep holding down the shutter button completely.



- With [**3**: Long exp. noise reduction], you can reduce the noise generated during long exposures (p.172).
- For bulb exposures, using a tripod and bulb timer is recommended. Using mirror lockup (p.219) with bulb exposures is also possible.
- You can also shoot bulb exposures by using Remote Switch RS-60E3 (sold separately, p.221).
- You can also use Remote Controller RC-6 (sold separately, p.221) for bulb exposures. When you press the remote controller's transmit button, the bulb exposure will start immediately or 2 sec. later. Press the button again to stop the bulb exposure.

TIMER Bulb Timer[☆]

You can preset the bulb exposure's exposure time. With the bulb timer, you need not keep holding down the shutter button during the bulb exposure. This reduces camera vibration blur.

The bulb timer can be set only in the <**B**> (Bulb) shooting mode. It cannot be set (or will not function) in any other shooting mode.

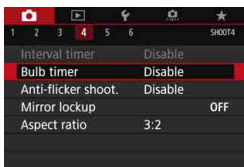

1 Select [**Bulb timer**].

- Under the [**4**] tab, select [**Bulb timer**], then press <SET>.

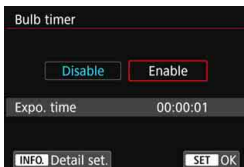

2 Select [**Enable**].

- Select [**Enable**], then press the <INFO.> button.

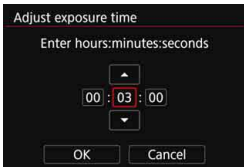

3 Set the desired exposure time.

- Select the hour, minute, or second.
- Press <SET> so <⏱> is displayed.
- Set the desired number, then press <SET>. (Returns to <□>.)

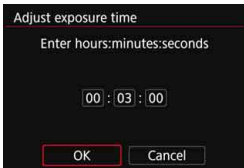

4 Select [OK].

- ▶ The set time will be displayed on the menu screen.
- ▶ When you exit the menu, <TIMER> will be displayed on the LCD panel.

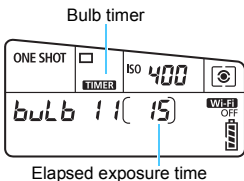

5 Take the picture.

- ▶ Press the shutter button completely, and the bulb exposure will start and continue until the set time elapses.
- To cancel the timer setting, set [Disable] in step 2.

- If you press the shutter button completely and then let go while the bulb timer is operating, the bulb exposure will stop.
- Doing any of the following will cancel the bulb timer (reverts to [Disable]): Set the power switch to <OFF>, switch to movie shooting, or change to a shooting mode other than .

HDR : HDR (High Dynamic Range) Shooting ☆

Clipped highlights and shadows will be reduced for a high dynamic range of tones even with high-contrast scenes. HDR shooting is effective for landscape and still-life shots.

With HDR shooting, three images of different exposures (standard exposure, underexposure, and overexposure) are captured continuously for each shot and then merged together automatically. The HDR image is recorded as a JPEG image.

* HDR stands for High Dynamic Range.



1 Select [HDR Mode].

- Under the [**H3**] tab, select [**HDR Mode**], then press < (SET) >.
- ▶ The HDR mode screen will appear.

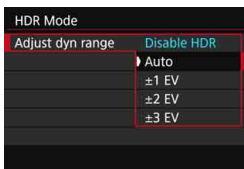

2 Set [Adjust dyn range].

- Select the desired dynamic range setting, then press < (SET) >.
- Selecting [**Auto**] will have the dynamic range set automatically depending on the image's overall tonal range.
- The higher the number, the wider the dynamic range will be.
- To exit HDR shooting, select [**Disable HDR**].

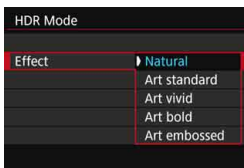

3 Set [Effect].

- Select the desired effect, then press < (SET) >.

Effects

- **Natural**

For images preserving a wide tonal range where the highlight and shadow details would otherwise be lost. Clipped highlights and shadows will be reduced.

- **Art standard**

While the clipped highlights and shadows will be reduced more than with **[Natural]**, the contrast will be lower, and the gradation flatter to have the picture look like a painting. The subject outlines will have bright (or dark) edges.

- **Art vivid**

The colors are more saturated than with **[Art standard]**, and the low contrast and flat gradation create a graphic art effect.

- **Art bold**

The colors are the most saturated, making the subject pop out, and the picture look like an oil painting.

- **Art embossed**

The color saturation, brightness, contrast and gradation are decreased to make the picture look flat. The picture looks faded and old. The subject outlines will have bolder bright (or dark) edges.

	Art standard	Art vivid	Art bold	Art embossed
Saturation	Standard	High	Higher	Low
Bold outline	Standard	Weak	Strong	Stronger
Brightness	Standard	Standard	Standard	Dark
Tone	Flat	Flat	Flat	Flatter

 Each effect will be applied based on the characteristics of the Picture Style currently set (p.154).

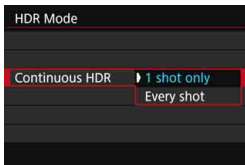

4 Set [Continuous HDR].

- Select either [**1 shot only**] or [**Every shot**], then press < (SET) >.
- With [**1 shot only**], HDR shooting will be canceled automatically after the shooting ends.
- With [**Every shot**], HDR shooting continues until the setting in step 3 is set to [**Disable HDR**].

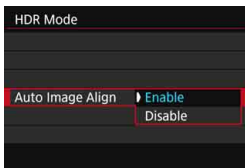

5 Set [Auto Image Align].

- For handheld shooting, select [**Enable**]. When using a tripod, select [**Disable**], then press < (SET) >.

6 Take the picture.

- HDR shooting is possible with viewfinder shooting and Live View shooting.
- When you press the shutter button completely, three consecutive images will be captured, and the HDR image will be recorded to the card.

- You cannot select RAW or RAW+JPEG. The HDR mode cannot be set if RAW or RAW+JPEG is set.
- The HDR mode cannot be set when AEB, WB bracketing, Multi Shot Noise Reduction, or multiple exposures are set, or during bulb exposures and movie shooting.
- HDR shooting is not possible with ISO expansion (H). HDR shooting is possible within ISO 100 - ISO 16000.
- The flash will not fire during HDR shooting.
- During HDR shooting, the settings of [Distortion correction], [📷2: Auto Lighting Optimizer], and [📷3: Highlight tone priority] will be automatically switched to [Disable].
- If you shoot a moving subject, the moving subject may leave afterimages.
- In HDR shooting, 3 images are captured with different shutter speeds set automatically. Therefore, even in <Tv> and <M> shooting modes, the shutter speed will be shifted based on the shutter speed you set.
- To prevent camera shake, a high ISO speed may be set.
- You can display <📷> in the viewfinder when HDR mode is set (p.425).

During Live View Shooting

- Magnified view is not possible.
- The Live View image displayed with the effect applied will not look exactly the same as the actual image.



- When shooting HDR images with [**Auto Image Align**] set to [**Enable**], AF point display information (p.352) and Dust Delete Data (p.405) will not be appended to the image.
- If you perform handheld HDR shooting with [**Auto Image Align**] set to [**Enable**], image periphery will be slightly trimmed and resolution will be slightly lowered. Also, if the images cannot be aligned properly due to camera shake, etc., auto image alignment may not take effect. Note that when shooting with excessively bright (or dark) exposure settings, auto image alignment may not work properly.
- If you perform handheld HDR shooting with [**Auto Image Align**] set to [**Disable**], the 3 images may not be properly aligned and the HDR effect may be minimal. Using a tripod is recommended.
- Auto image alignment may not work properly with repetitive patterns (lattice, stripes, etc.) or flat, single-tone images.
- The color gradation of the sky or white walls may not be reproduced correctly. Irregular exposure, irregular colors, or noise may appear.
- HDR shooting under fluorescent or LED lighting may result in unnatural color reproduction of the illuminated areas.
- With HDR shooting, it takes some time to record images to the card since they are merged after shooting. During the processing of the images, “**buSY**” will be displayed in the viewfinder and on the LCD panel, and you cannot take another picture until the processing is completed.
- If you change the shooting mode or switch to movie shooting after setting HDR shooting, HDR shooting setting may be cleared ([**Adjust dyn range**] setting may be switched to [**Disable HDR**]).

Multiple Exposures ☆

You can shoot two to nine exposures to be merged into one image. With Live View shooting (p.255), you can see in real time how the exposures are merged when you shoot multiple-exposure images.



1 Select [Multiple exposure].

- Under the [**3**] tab, select [**Multiple exposure**], then press <SET>.

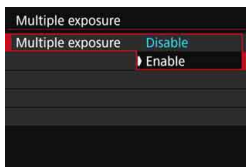

2 Set [Multiple exposure].

- Select [**Enable**], then press <SET>.
- To exit shooting multiple exposures, select [**Disable**].

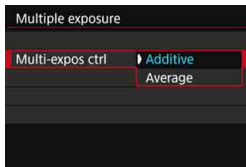

3 Set [Multi-expos ctrl].

- Select the desired multiple-exposure control method, then press <SET>.

● Additive

The exposure of each single image captured is added cumulatively. Based on the [**No. of exposures**], set a negative exposure compensation. Refer to the basic guide below to set the exposure compensation amount.

Exposure Compensation Setting Guide for Multiple Exposures

Two exposures: -1 stop, three exposures: -1.5 stop, four exposures: -2 stops



The noise, irregular colors, banding, etc. of the image displayed during shooting with [**Additive**] set may be different from the final multiple-exposure image recorded.

● Average

Based on the **[No. of exposures]**, negative exposure compensation is set automatically as you shoot multiple exposures. If you shoot multiple exposures of the same scene, the exposure of the subject's background will be automatically controlled to obtain the standard exposure.



4 Set the **[No. of exposures]**.

- Set the number of exposures, then press <SET>.
- You can set it from 2 to 9 exposures.



5 Set **[Continue Mult-exp]**.

- Select either **[1 shot only]** or **[Continuously]**, then press <SET>.
- With **[1 shot only]**, multiple-exposure shooting will be canceled automatically after the shooting ends.
- With **[Continuously]**, multiple-exposure shooting continues until the setting in step 2 is set to **[Disable]**.



Remaining number of exposures

6 Take the first exposure.

- ▶ The captured image will be displayed.
- ▶ The <[]> icon will blink.
- You can check the remaining exposures in the brackets [] in the viewfinder or on the screen.
- Pressing the <[]> button enables you to view the captured image (p.217).

7 Shoot subsequent exposures.

- ▶ The merged multiple-exposure image will be displayed.
- With Live View shooting, the multiple-exposure images merged so far will be displayed. By pressing the <INFO.> button, you can display only the Live View image.
- Multiple-exposure shooting will end when the set number of exposures are taken. With continuous shooting, if you keep holding down the shutter button, the shooting continues until the set numbers of exposures are taken.



- During continuous shooting, the continuous shooting speed will decrease greatly.
- Only the merged multiple-exposure image will be saved. The images taken in steps 6 and 7 for the multiple-exposure image will not be saved.
- The image-recording quality, ISO speed, Picture Style, high ISO speed noise reduction and color space, etc. set for the first single exposure will also be set for the subsequent exposures.
- You cannot set an aspect ratio for multiple-exposure shooting. Images will be taken with a 3:2 aspect ratio.
- If WB bracketing, Multi Shot Noise Reduction, HDR mode, or a Creative filter is set, multiple-exposure shooting cannot be set.
- During multiple-exposure shooting, the settings of [**1: Lens aberration correction**], [**2: Auto Lighting Optimizer**], and [**3: Highlight tone priority**] will be automatically switched to [**Disable**].
- If [**3: Picture Style**] is set to [**Auto**], [**Standard**] will be applied for shooting.
- With multiple exposures, the more exposures there are, the more noticeable the noise, irregular colors, and banding will be. Also, as noise increases with higher ISO speeds, shooting at low ISO speeds is recommended.
- If [**Additive**] is set, the image processing after taking the multiple exposures will take time. (The access lamp will light up longer.)
- If you perform Live View shooting with [**Additive**] set, the Live View function will stop automatically when the multiple-exposure shooting ends.
- In step 7, the brightness and noise of the multiple-exposure image displayed during Live View shooting will be different from the final multiple-exposure image recorded.
- Multiple-exposure shooting will be canceled if the power switch is set to <OFF> or if you switch to movie shooting.
- If you switch the shooting mode to a Basic Zone mode, <G1>, or <G2> during shooting, multiple-exposure shooting will end.
- If you connect the camera to a computer, multiple-exposure shooting will not be possible. If you connect the camera to a computer during shooting, multiple-exposure shooting will end.



You can press the <▶> button to view the multiple exposures taken so far or delete the last single exposure (p.217).

Merging Multiple Exposures with an Image Recorded on the Card

You can select a **RAW** image recorded on the card as the first single exposure. The image data of the selected **RAW** image will remain intact. **You can only select RAW images.** You cannot select **M RAW/S RAW** or JPEG images.



1 Select [Select image for multi. expo.].

- ▶ The images on the card will be displayed.

2 Select the first image.

- Turn the <⊙> dial to select the image to be used as the first single exposure, then press <SET>.
- Select **[OK]**.
- ▶ The file number of the selected image will be displayed at the bottom of the screen.

3 Take the picture.

- When you select the first image, the number of remaining exposures as set with **[No. of exposures]** will decrease by 1. For example, if **[No. of exposures]** is 3, you can shoot two exposures.

- Images shot with [**3: Highlight tone priority**] set to **[Enable]** and images whose [**4: Aspect ratio**] is set to any setting other than **[3:2]** (p.146) cannot be selected as the first single exposure.
- **[Disable]** will be applied for [**1: Lens aberration correction**] and [**2: Auto Lighting Optimizer**] regardless of the settings of the **RAW** image selected as the first single exposure.
- The ISO speed, Picture Style, high ISO speed noise reduction, color space, etc. set for the first **RAW** image will also be applied for the subsequent images.
- If [**3: Picture Style**] is **[Auto]** for the RAW image selected as the first **RAW** image, **[Standard]** will be applied for shooting.
- You cannot select an image taken with another camera.

- You can also select a **RAW** multiple-exposure image as the first single exposure.
- If you select **[Deselect img.]**, the selected image will be canceled.

Checking and Deleting Multiple Exposures During Shooting

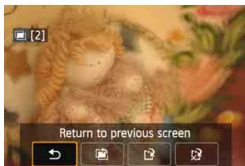

Before you finish shooting the set number of exposures, you can press the <▶> button to check the current exposure level, overlap alignment, and overall effect of the merged multiple-exposure image.

If you press the <🗑> button, the operations possible during multiple-exposure shooting will be displayed.

Operation	Description
Undo last image	Deletes the last image you shot (shoot another image). The number of remaining exposures will increase by 1.
Save and exit	The images shot so far will be merged and saved as a multiple-exposure image.
Exit without saving	Multiple-exposure shooting will exit without saving the images shot.
Return to previous screen	The screen before you pressed the <🗑> button will reappear.

During multiple-exposure shooting, you can only play back multiple-exposure images.

? FAQ

- **Are there any restrictions on the image-recording quality?**

All JPEG image-recording quality settings can be selected. If **M RAW** or **S RAW** is set, the merged multiple-exposure image will be a **RAW** image.

Image-Recording Quality Setting	Merged Multiple-Exposure Image
JPEG	JPEG
RAW	RAW
M RAW / S RAW	RAW
RAW +JPEG	RAW +JPEG
M RAW / S RAW +JPEG	RAW +JPEG

- **Can I merge images recorded on the card?**

With [**Select image for multi. expo.**], you can select the first single exposure from the images recorded on the card (p.216). Note that you cannot merge multiple images already recorded on the card.

- **Are multiple exposures possible with Live View shooting?**

You can shoot multiple exposures with Live View shooting (p.255).

- **Will auto power off take effect during multiple-exposure shooting?**

As long as [**2: Auto power off**] is set to any setting other than [**Disable**], the timing for auto power off to automatically take effect will all become after approx. 30 min. of idle time. If the auto power off takes effect, multiple-exposure shooting will end, and multiple-exposure settings will be canceled.

Before starting the multiple-exposure shooting, the auto power off will take effect at the time set with the camera, and multiple-exposure settings will be canceled.

Mirror Lockup ☆

Camera vibrations caused by the mirror's reflex action when the picture is taken is called "mirror shock". Mirror lockup keeps the mirror up before and during exposure to reduce blur caused by camera vibrations. Useful when shooting close-ups (macro photography), using a super telephoto lens, and shooting at slow shutter speeds.

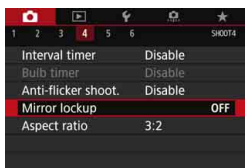

1 Set [Mirror lockup] to [Enable].

- Under the [4] tab, select [Mirror lockup], then press <SET>.
- Select [Enable], then press <SET>.

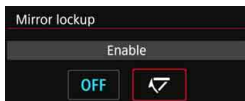

2 Focus on the subject, then press the shutter button completely.

- ▶ The mirror will swing up.

3 Press the shutter button completely again.

- ▶ The picture is taken and the mirror goes back down.



- Do not point the camera toward an intense light source, such as the sun or an intense artificial light source. Doing so may damage the image sensor or the camera's internal components.
- In very bright light, such as at the beach or a ski slope on a sunny day, take the picture promptly after mirror lockup is stabilized.
- If you use the self-timer and bulb exposure in combination with a mirror lockup, keep pressing the shutter button completely (self-timer delay time + bulb exposure time). If you let go of the shutter button during the self-timer countdown, there will be a shutter-release sound, but no picture will be taken.
- During mirror lockup, shooting function settings and menu operations, etc. are disabled.

- Even if the drive mode is set to continuous shooting, only one shot can be taken.
- You can also use the self-timer with mirror lockup.
- If approx. 30 sec. elapse after the mirror is locked up, it will go back down automatically. Pressing the shutter button completely again locks up the mirror again.
- When shooting with mirror lockup, using a tripod and Remote Switch RS-60E3 (sold separately, p.221) is recommended.
- You can also use a remote controller (sold separately, p.221) with mirror lockup. Setting the remote controller to a 2-sec. delay is recommended.

Using the Eyepiece Cover

When you take a picture without looking through the viewfinder, such as when you use the self-timer, bulb exposure, or a remote switch, stray light entering the viewfinder can cause the picture to look dark. To prevent this, use the eyepiece cover (p.33) attached to the camera strap.

During Live View shooting and movie shooting, attaching the eyepiece cover is unnecessary.

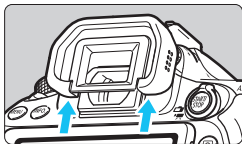

1 Detach the eyecup.

- Push the bottom of the eyecup to detach it.

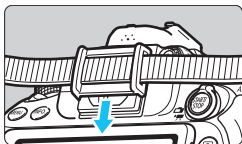

2 Attach the eyepiece cover.

- Slide the eyepiece cover down into the eyepiece groove to attach it.
- After you finish shooting, detach the eyepiece cover and attach the eyecup.

Using a Remote Switch

You can connect Remote Switch RS-60E3 (sold separately) to the camera and shoot (p.468).

For detailed instructions, refer to the remote switch's instruction manual.

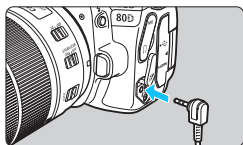

- 1 Open the terminal cover.
- 2 Connect the plug to the remote control terminal.

Remote Control Shooting



With Remote Controller RC-6 (sold separately), you can shoot remotely up to approx. 5 meters/16.4 feet away from the camera. You can either shoot immediately or with a 2-sec. delay.

You can also use Remote Controller RC-1 and RC-5 (sold separately).

- 1 Focus on the subject.
- 2 Set the lens's focus mode switch to <MF>.
 - You can also shoot with <AF>.
- 3 Press the <DRIVE> button (ⓘ6).

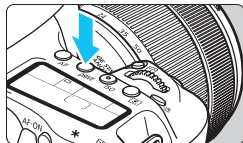

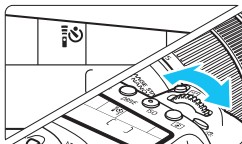

4 Select the self-timer.

- Look at the LCD panel and turn the dial to select or .

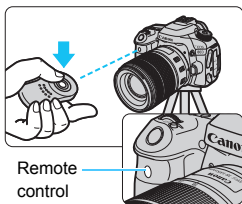

5 Press the remote controller's transmit button.

- Point the remote controller toward the camera's remote control sensor, and press the transmit button.
- ▶ The self-timer lamp lights up and the picture is taken.

- Fluorescent or LED lighting may cause camera misoperation by triggering the shutter inadvertently. Try to keep the camera away from such light sources.
- If you point a remote controller for a TV set toward the camera and operate it, it may cause camera misoperation by triggering the shutter inadvertently.
- If flash light is emitted from a flash on another camera around this camera, it may cause camera misoperation by triggering the shutter inadvertently. Do not expose the remote control sensor to flash light from a flash on another camera.

Remote control shooting is also possible with an EX-series Speedlite equipped with a remote-release function.

TIMER Interval Timer Shooting

With the interval timer, you can set the shooting interval and the number of shots. The camera will take a series of single shots at the set interval until the set number of shots are taken.

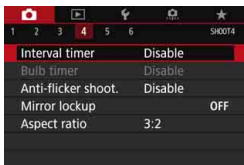

1 Select [Interval timer].

- Under the [📷4] tab (the [📷2] tab in Basic Zone modes), select [Interval timer], then press <SET>.

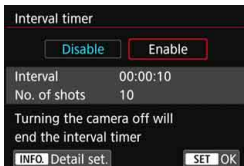

2 Select [Enable].

- Select [Enable], then press the <INFO.> button.



3 Set the shooting interval and number of shots.

- Select the number to be set (hours: minutes: seconds / number of shots).
- Press <SET> so <⏏> is displayed.
- Set the desired number, then press <SET>. (Returns to <□>.)

• Interval

Settable from [00:00:01] to [99:59:59].

• No. of shots

Settable from [01] to [99]. If you set [00], the camera will keep shooting until you stop the interval timer.

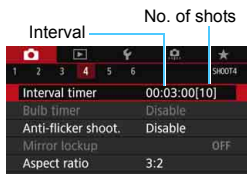

4 Select [OK].

- ▶ The interval timer settings will be displayed on the menu screen.
- ▶ When you exit the menu, **<TIMER>** will be displayed on the LCD panel.

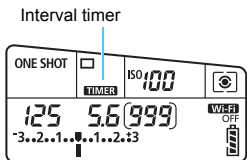

5 Take the picture.

- ▶ After taking the first shot, subsequent shots will be taken according to the interval timer settings.
- During interval timer shooting, **<TIMER>** will blink.
- After the set number of shots are taken, the interval timer shooting will stop and be automatically canceled.

- Using a tripod is recommended.
- Taking test shots is recommended.
- After the interval timer shooting starts, you can still press the shutter button completely to take a picture as usual. However, from 5 sec. before the next interval timer shooting, the shooting function settings, menu operation, image playback, and other operations will be suspended and the camera will return to shooting-ready state.
- If a picture is being taken or an image is being processed when the next shot is scheduled on the interval timer, the shot set for that time will be skipped. The camera will thereby shoot fewer shots than the number set for interval timer shooting.
- Auto power off operates with the interval timer. The power will automatically turn on approx. 1 min. before the next shot.
- Interval timer shooting can be combined with AEB, WB bracketing, multiple exposures, and HDR mode.
- You can stop the interval timer shooting by selecting [**Disable**] or turning the power switch to **<OFF>**.



- Do not point the camera toward an intense light source, such as the sun or an intense artificial light source. Doing so may damage the image sensor or the camera's internal components.
- If the lens's focus mode switch is set to <AF>, the camera will not shoot when focus is not achieved. Setting it to <MF> and focusing manually is recommended.
- Live View shooting, movie shooting, or bulb exposures cannot be performed with interval timer.
- If the shooting time is long, using DC Coupler DR-E6 (sold separately) and AC Adapter AC-E6N (sold separately) is recommended.
- If a shutter speed longer than the shooting interval is set, such as a long exposure, the camera cannot shoot with the set interval. The camera will thereby shoot fewer shots than the number set for interval timer shooting. Also, the number of shots may decrease when the shutter speed and the shooting interval are nearly the same.
- If the image recording time on the card is longer than the set shooting interval due to card performance or shooting settings, etc., the camera may not shoot with the set shooting interval.
- If you use flash with interval timer shooting, set an interval longer than the flash's recycling time. If the interval is too short, the flash may not fire.
- If the shooting interval is too short, the camera may not take a picture or may capture an image without autofocusing.
- Interval timer shooting will be canceled and reset to **[Disable]** if you do any of the following: Set the power switch to <OFF>, display the Live View or movie shooting screen, set the shooting mode to or <G1/G2>, or use EOS Utility (EOS software, p.512).
- After interval timer shooting starts, you cannot use remote control shooting (p.221) or remote-release shooting with an EOS-dedicated, external Speedlite.
- If your eye will not remain on the viewfinder eyepiece during interval timer shooting, attach the eyepiece cover (p.220). If stray light enters the viewfinder when the picture is taken, it may throw off the exposure.

6

Flash Photography

This chapter explains how to shoot with built-in flash and external Speedlites (EX-series, sold separately), how to set flash settings on the camera's menu screen, and how to use the built-in flash for wireless flash shooting.



- Flash cannot be used with movie shooting. It will not fire.
- AEB cannot be used with flash.

⚡ Using the Built-in Flash

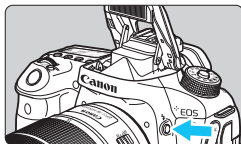

In Creative Zone modes, just press the <⚡> button to raise the built-in flash for flash photography.

Before shooting, check that [⚡] is displayed in the viewfinder. After shooting, push the built-in flash back down with your fingers until it clicks into place.

In Basic Zone modes, depending on the shooting mode, you can set the built-in flash with Quick Control (p.107).

The table below shows the shutter speed and aperture settings that will be used with flash.

Shooting Mode	Shutter Speed	Aperture
P	Automatically set (1/250 sec. - 1/60 sec.)	Automatically set
Tv	Manually set (1/250 sec. - 30 sec.)	Automatically set
Av	Automatically set (1/250 sec. - 30 sec.)	Manually set
M	Manually set (1/250 sec. - 30 sec.)	Manually set
B	Exposure continues while you hold down the shutter button or while the bulb timer is operating.	Manually set

Flash Photography in the <Av> Mode

To obtain a correct flash exposure, the flash output will be set automatically (autoflash exposure) to match the manually-set aperture. The shutter speed will be set automatically between 1/250 sec. - 30 sec. to suit the scene's brightness.

In low light, the main subject is exposed with the auto flash metering, and the background is exposed with a slow shutter speed set automatically. Both the subject and background look properly exposed with a touch of atmosphere (automatic slow-speed flash sync). If you are handholding the camera, keep it steady to prevent camera shake. Using a tripod is recommended.

To prevent a slow shutter speed, under [ 1: Flash control], set [Flash sync. speed in Av mode] to [1/250-1/60sec. auto] or [1/250 sec. (fixed)] (p.236).

Effective Range of Built-in Flash (Approx. in meters / feet)

ISO Speed (p.148)	EF-S18-135mm f/3.5-5.6 IS USM	
	Wide Angle	Telephoto
	f/3.5	f/5.6
ISO 100	1 - 3.4 / 3.3 - 11.2	1 - 2.1 / 3.3 - 6.9
ISO 400	1 - 6.9 / 3.3 - 22.6	1 - 4.3 / 3.3 - 14.1
ISO 1600	1.7 - 13.7 / 5.6 - 44.9	1.1 - 8.6 / 3.6 - 28.2
ISO 6400	3.4 - 27.4 / 11.2 - 89.9	2.1 - 17.1 / 6.9 - 56.1

* When a high ISO speed is set and focusing distance is long, appropriate exposure may not be obtained depending on the subject conditions, etc.



- Detach any lens hood when shooting with the built-in flash.
- If a lens hood is attached or if the subject is too close, the built-in flash will be obstructed and the bottom of the captured image may look dark.
- Do not perform flash photography when the built-in flash is held down with your finger or not fully raised for some other reason.



If you use a super telephoto lens or large-aperture lens and the bottom of the picture looks dark, using an external Speedlite (sold separately, p.233) is recommended.

MENU Red-eye Reduction

Using the red-eye reduction lamp before taking a flash picture can reduce red eye.

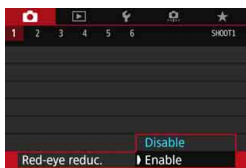

- 1 Select [Red-eye reduc.].**
 - Under the [**1**] tab, select [**Red-eye reduc.**], then press **<SET>**.
- 2 Select [Enable].**
 - For flash photography, when you press the shutter button halfway, the red-eye reduction lamp will be emitted.

- The red-eye reduction feature is more effective when the subject looks at the red-eye reduction lamp, when the room is well lit, or when you are close to the subject.
- When you press the shutter button halfway, the scale display on the bottom of the viewfinder will shrink and turn off. For best results, take the picture after this scale display turns off.
- The effectiveness of red-eye reduction varies depending on the individual subject.



Flash Exposure Compensation ☆

Set flash exposure compensation if the flash exposure of the subject does not come out as desired. You can set the flash exposure compensation up to ± 3 stops in 1/3-stop increments.

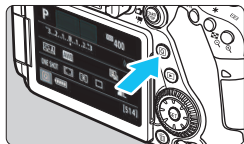

- 1 Press the **<Q>** button (10).**
 - The Quick Control screen will appear.



2 Select [**FL**].

- Press the <▲> <▼> or <◀> <▶> keys to select [**FL***], then press <SET>.
- ▶ The flash exposure compensation setting screen will appear.

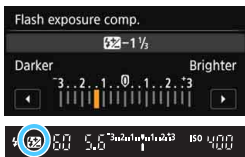

3 Set the flash exposure compensation amount.

- To make the flash exposure brighter, turn the <☉> or <☀> dial to the right (increased exposure). To make it darker, turn the <☉> or <☀> dial to the left (decreased exposure).
- ▶ When you press the shutter button halfway, the <FL> icon will appear in the viewfinder.
- After taking the picture, follow steps 1 to 3 and set the flash exposure compensation amount to 0.



- If [**2: Auto Lighting Optimizer**] (p.169) is set to any setting other than [**Disable**], the image may still look bright even if a decreased flash exposure compensation is set.
- If flash exposure compensation is set with an external Speedlite (sold separately, p.233), you cannot set the flash exposure compensation with the camera. If it is set with both the camera and external Speedlite, the Speedlite's setting overrides the camera's.



- The exposure compensation amount will remain in effect even after you set the power switch to <OFF>.
- You can also set flash exposure compensation with [**Built-in flash settings**] in [**1: Flash control**] (p.235).
- The camera can also be used to set the external Speedlite's flash exposure compensation in the same way as with the built-in flash.

✳ FE Lock ☆

FE (flash exposure) lock obtains and locks the appropriate flash exposure for the desired part of the image.

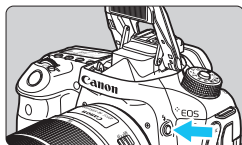

1 Press the <⚡> button.

- ▶ The built-in flash will be raised.
- Press the shutter button halfway and look in the viewfinder to check that the <⚡> icon is lit.



2 Focus on the subject.



3 Press the <✳> button (Ⓜ16).

- Aim the viewfinder center over the subject where you want to lock the flash exposure, then press the <✳> button.
- ▶ The flash will fire a preflash and the required flash output is calculated and retained in memory.
- ▶ In the viewfinder, "FEL" is displayed for a moment and <⚡✳> will light up.
- Each time you press the <✳> button, a preflash is fired and the required flash output is calculated and retained in memory.



4 Take the picture.

- Compose the shot and press the shutter button completely.
- ▶ The flash is fired, and the picture is taken.



- If the subject is too far away and beyond the effective range of the flash, the <⚡> icon will blink. Move closer to the subject and repeat steps 2 to 4.
- FE lock is not possible during Live View shooting.

⚡ Using an External Speedlite

EOS-dedicated, EX-series Speedlites

Using an EX-series Speedlite (sold separately) makes flash photography easy.

For detailed instructions, refer to the EX-series Speedlite's instruction manual. This camera is a Type-A camera that can use all the features of EX-series Speedlites.

To set the flash functions and flash Custom Functions with the camera's menu, see pages 235-243.



Shoe-mount Speedlites



Macro Lites

- **Flash exposure compensation**

Set it with Quick Control (p.56) or [**External flash func. setting**] under [**1: Flash control**] (p.240). With Quick Control, you can set flash exposure compensation in the same way as for the built-in flash. See page 230.

- **FE lock**

Set this in the same way as for the built-in flash. See steps 2 to 4 on page 232.



If it is difficult to achieve focus with autofocus, the EOS-dedicated, external Speedlite will automatically emit the AF-assist beam as necessary.

Canon Speedlites Other Than the EX-series

- With an EZ/E/EG/ML/TL-series Speedlite set to A-TTL or TTL autoflash mode, the flash can be fired at full output only. Set the camera's shooting mode to <M> (manual exposure) or <Av> (aperture-priority AE) and adjust the aperture setting before shooting.
- When using a Speedlite that has manual flash mode, shoot in the manual flash mode.

Non-Canon Flash Units

Sync Speed

The camera can synchronize with non-Canon compact flash units at 1/250 sec. and slower speeds. With large studio flash units, be sure to test the flash synchronization before shooting with the sync speed set within approx. 1/60 sec. to 1/30 sec. The flash duration of such units is longer than that of compact flash units and varies depending on the model.

Cautions for Live View Shooting

If you use a non-Canon flash unit with Live View shooting, set [ 6: Silent LV shoot.] to [Disable] (p.272). The flash will not fire if it is set to [Mode 1] or [Mode 2].

- If the camera is used with a flash unit or flash accessory dedicated to another camera brand, the camera may not operate properly and malfunction may result.
- Do not attach a high-voltage flash unit on the camera's hot shoe. It may not fire.

MENU Setting the Flash ☆

With the built-in flash or an EX-series, external Speedlite compatible with flash function settings, you can use the camera's menu screen to set flash functions and the external Speedlite's Custom Functions. **If you use an external Speedlite, attach the Speedlite to the camera and turn on the Speedlite before setting the flash functions.** For details on the external Speedlite's flash functions, refer to the Speedlite's instruction manual.

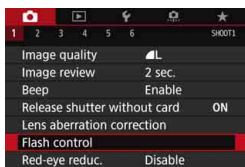

1 Select [Flash control].

- Under the [**1**] tab, select [**Flash control**], then press <SET>.
- ▶ The Flash control screen will appear.

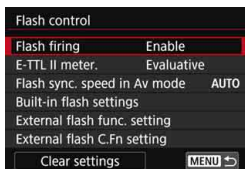

2 Select the desired item.

- Select the menu option to be set, then press <SET>.

Flash Firing



To enable flash photography, set [**Enable**]. To enable only the AF-assist beam to be emitted, set [**Disable**].

E-TTL II Metering

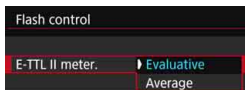

For normal flash exposures, set it to [**Evaluative**]. If [**Average**] is set, the flash exposure will be averaged for the entire metered scene. Depending on the scene, flash exposure compensation may be necessary. This setting is for advanced users.

Flash Synchronization Speed in Av Mode

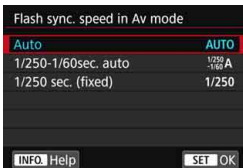

You can set the flash-sync speed for flash photography in the aperture-priority AE < **Av** > mode.

- **AUTO: Auto**

The flash sync speed is set automatically within a range of 1/250 sec. to 30 sec. to suit the scene's brightness. High-speed sync is also possible.

- ^{1/250}_{-1/60} **A: 1/250-1/60 sec. auto**

Prevents a slow shutter speed from being set in low-light conditions. It is effective for preventing subject blur and camera shake. However, while the subject will be properly exposed with the flash, the background may come out dark.

- **1/250: 1/250 sec. (fixed)**

The flash-sync speed is fixed at 1/250 sec. This more effectively prevents subject blur and camera shake than with [**1/250-1/60sec. auto**]. However, in low light, the subject's background will come out darker than with [**1/250-1/60sec. auto**].

ⓘ If [**1/250-1/60sec. auto**] or [**1/250 sec. (fixed)**] is set, high-speed sync is not possible in the < **Av** > mode with the external Speedlite.

Displaying the Flash Function Setting Screen Directly

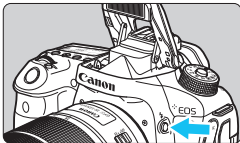

When you use the built-in flash or an external, EX-series Speedlite compatible with flash function settings, you can press the $\lt;/math> button to directly display the **[Built-in flash settings]** or **[External flash func. setting]** screen without first displaying the menu screen.$

● With built-in flash

Built-in flash settings	
Flash mode	E-TTL II
Shutter sync.	1st curtain
exp. comp.	3..2..1..0..1..2..3
Wireless func.	Disable

Press the $\lt;/math> button twice.$

- Press the button to raise the built-in flash.
- Press the button again to display the **[Built-in flash settings]** screen.
- If **[Flash firing]** is set to **[Disable]**, the **[CAMERA 1: Flash control]** screen will appear (p.235).

● With external Speedlite

External flash func. setting		
ETTL	WIRELESS OFF	Zoom AUTO
\llcorner	± 0	FEB ± 0
E-TTL II flash metering		

Press the $\lt;/math> button.$

- With the external Speedlite turned on, press the $\lt;/math> button to display the **[External flash func. setting]** screen.$

ⓘ When you press the $\lt;/math> button to display the flash function setting screen, you cannot set **[Flash firing]**, **[E-TTL II meter.]**, **[Flash sync. speed in Av mode]**, or **[External flash C.Fn setting]**. Set these functions with **[CAMERA 1: Flash control]** instead.$

Built-in Flash Settings

● Flash mode

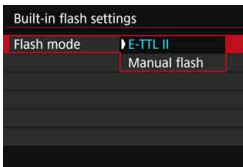

Normally, set this to **[E-TTL II]**. This enables autoexposure shooting with the built-in flash.

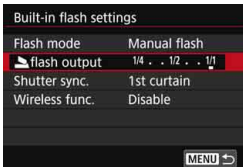

To set the flash output level manually, select **[Manual flash]**.
Select **[flash output]**, then set the flash output level to within 1/1 - 1/128 (1/3-stop increments) before shooting.

● Shutter synchronization

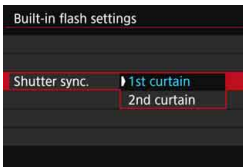

Normally, set this to **[1st curtain]** so that the flash fires immediately after the exposure starts.

If **[2nd curtain]** is set, the flash will fire right before the shutter closes. When this is combined with a slow shutter speed, you can create a trail of light such as from car headlights at night with a more natural feel. When second-curtain synchronization is set together with **[E-TTL II]**, the flash will be fired twice in a row: once when you press the shutter button completely and once right before the end of the exposure.

 When using second-curtain synchronization, set the shutter speed to 1/25 sec. or slower. If the shutter speed is 1/30 sec. or faster, first-curtain synchronization will be applied automatically even if **[2nd curtain]** is set.

● Flash exposure compensation

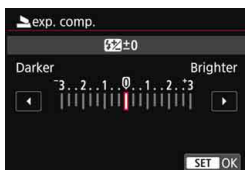

The same setting as step 3 in “Flash Exposure Compensation” on page 230 can be set.

● Wireless functions

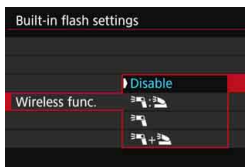

With wireless flash photography (via optical transmission), you can use the built-in flash to wirelessly control external Speedlites.

For details, see “Wireless Flash Photography” on page 244.

External Flash Function Settings

The screen display and setting options will vary depending on the external Speedlite model, current flash mode, Speedlite's Custom Function settings, etc.

For the functions compatible with your Speedlite (sold separately), refer to the Speedlite's instruction manual.

Sample display

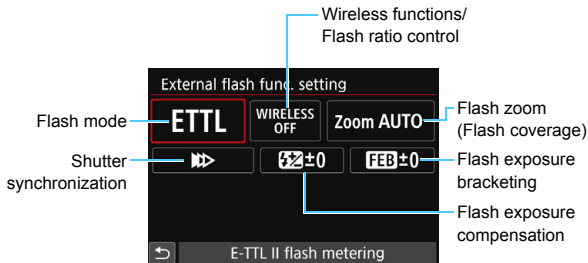

● Flash mode

You can select the flash mode to suit your desired flash shooting.

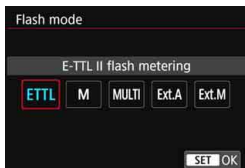

[E-TTL II] is the standard mode of EX-series Speedlites for automatic flash shooting.

[Manual flash] is for setting the Speedlite's **[Flash output level]** yourself.

Regarding other flash modes, refer to the instruction manual of a Speedlite compatible with the functions.

● Wireless functions / Flash ratio control

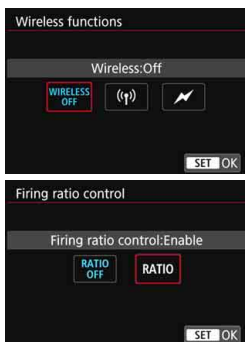

Wireless (multiple) flash shooting is possible with radio or optical transmission.

For details on wireless flash, refer to the instruction manual of a Speedlite compatible with wireless flash shooting. With a macro flash (MR-14EX II, etc.) compatible with flash function settings, you can set the flash ratio between flash tubes or flash heads A and B, or perform wireless flash with additional slave units. For details on flash ratio control, refer to the macro flash's instruction manual.

● Flash zoom (Flash coverage)

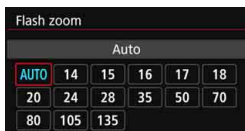

With Speedlites having a zooming flash head, you can set the flash coverage. Normally, set this to **[AUTO]** so that the camera will automatically set the flash coverage to match the lens focal length.

● Shutter synchronization

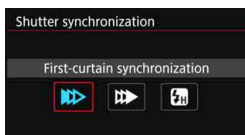

Normally, set this to **[First-curtain synchronization]** so that the flash fires immediately after the exposure starts.

If **[Second-curtain synchronization]** is set, the flash will fire right before the shutter closes. When this is combined with a slow shutter speed, you can create a trail of light such as from car headlights at night with a more natural feel. When second-curtain synchronization is set together with **[E-TTL II]**, the flash will be fired twice in a row: once when you press the shutter button completely and once right before the end of the exposure. If **[High-speed synchronization]** is set, the flash can be used at all shutter speeds. This is useful when you want to shoot with background blur (open aperture) in locations such as outdoors in daylight.

● Flash exposure compensation

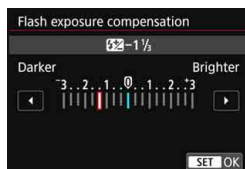

The same setting as step 3 in “Flash Exposure Compensation” on page 230 can be set.

For details, refer to the Speedlite’s instruction manual.

● Flash exposure bracketing



While the flash output is changed automatically, three shots are taken.

For details, refer to the instruction manual of a Speedlite compatible with flash exposure bracketing.

! When using second-curtain synchronization, set the shutter speed to 1/25 sec. or slower. If the shutter speed is 1/30 sec. or faster, first-curtain synchronization will be applied automatically even if **[Second-curtain synchronization]** is set.

- !** With an EX-series Speedlite not compatible with flash function settings, you can only set the following: **[Flash firing]**, **[E-TTL II meter.]**, and **[Flash exposure compensation]** under **[External flash func. setting]**. (**[Shutter synchronization]** can also be set with certain EX-series Speedlites.)
- If flash exposure compensation is set with an external Speedlite, you cannot set the flash exposure compensation with the camera (Quick Control or External flash function settings). If it is set with both the camera and external Speedlite, the Speedlite’s setting overrides the camera’s.

External Speedlite Custom Function Settings

For details on the external Speedlite's Custom Functions, refer to the Speedlite's instruction manual.

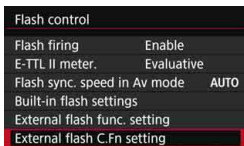

1 Select [External flash C.Fn setting].

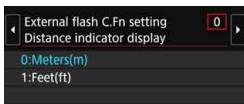

2 Set the desired function.

- Select the number, then press < (SET) >.
- Select the setting, then press < (SET) >.

 With an EX-series Speedlite, the Speedlite will always fire at full output if the [Flash metering mode] in Flash Custom Function is set to [TTL] (autoflash).

Clear Settings

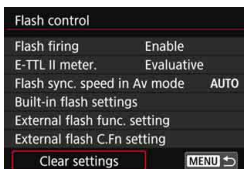

1 Select [Clear settings].

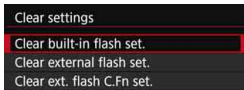

2 Select the settings to be cleared.

- Select [Clear built-in flash set.], [Clear external flash set.], or [Clear ext. flash C.Fn set.], then press < (SET) >.
- When you select [OK], the respective flash settings or all the Custom Function settings will be cleared.

 The Speedlite's Personal Function (P.Fn) cannot be set or canceled on the camera's [Flash control] screen. Set it with the Speedlite.

Wireless Flash Photography ☆

The camera's built-in flash can work as a master unit for Canon EX-series, external Speedlites having a wireless slave feature. It can wirelessly trigger the Speedlite(s) to fire via optical transmission. Be sure to read the instructions and cautions about wireless flash photography (optical transmission) in the Speedlite's instruction manual.

Slave Unit Settings and Position

Regarding your Speedlite (slave unit), refer to its instruction manual and set it as follows. The settings other than the ones below for the slave unit's control are all set with the camera. Different types of Speedlite slave units can be used and controlled together.

- (1) Set the external Speedlite as a slave unit.
- (2) Set the Speedlite's transmission channel to the same channel as set on the camera.*1
- (3) For flash ratio control, set the slave unit's firing group.
- (4) Position the camera and slave unit(s) within the range shown below.
- (5) Face the slave unit's wireless sensor toward the camera.*2

Example of Wireless Flash Set-up

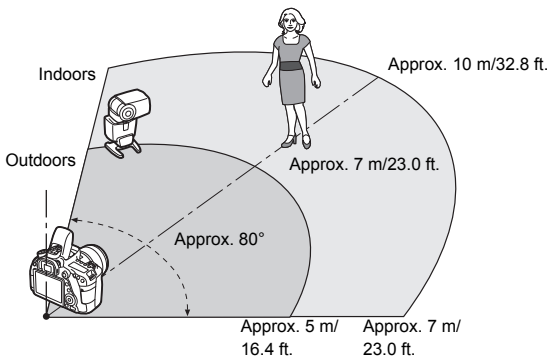

- *1: If the slave Speedlite does not have a transmission channel setting function, the flash can work regardless of the camera's channel setting.
- *2: In small rooms, the slave unit may work even if its wireless sensor does not face the camera. The camera's wireless signals can bounce off the walls and be received by the slave unit. When using an EX-series Speedlite with fixed light-emitting unit (flash head) and wireless sensor, take pictures while making sure it can fire.

- **Canceling the slave unit's auto power off**

To cancel the slave unit's auto power off, press the camera's <✳> button. If you are using manual flash firing, press the slave unit's test firing button to cancel the auto power off.



The camera's master function cannot be used for wireless flash photography with radio transmission.

Wireless Flash Photography Configurations

The tables below show the possible configurations for wireless flash shooting. Select the configuration suiting the subject, shooting conditions, the number of external Speedlites you use, etc.

	External Speedlite		Built-in Flash	Page	Setting	
	Quantity	A:B Flash Ratio			Wireless Functions	Firing Group
Fully Automatic (E-TTL II autoflash)	Single	-	-	p.247		All
	Single	-	Used	p.249	:	-
	Multiple	-	-	p.250		All
	Multiple	Set	-	p.251		(A:B)
	Multiple	-	Used	p.252	+	All and
	Multiple	Set	Used		+	(A:B)
	• Flash exposure compensation				p.253	
• FE lock						

	External Speedlite		Built-in Flash	Page	Setting	
	Quantity	A:B Flash Ratio			Wireless Functions	Firing Group
Manual Flash	Single/ Multiple	-	-	p.254		All
	Multiple	Set	-			(A:B)
	Single/ Multiple	-	Used		+	All and
	Multiple	Set	Used		+	(A:B)



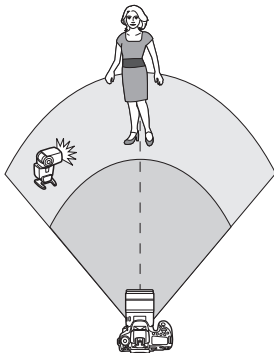

Even if you disable the built-in flash from firing, it will still fire in order to control the slave unit via optical transmission. The flash fired to control the slave unit may therefore appear in the picture depending on the shooting conditions.

Fully Automatic Shooting with One External Speedlite



This shows the most basic setup for fully-automatic wireless flash shooting with one external Speedlite.

Steps 1 to 4 and 6 apply to all wireless flash shooting. Therefore, these steps are omitted in other wireless flash setups explained on the pages hereafter.

On the menu screens, the  and  icons indicate the external Speedlite, and the  and  icons indicate the built-in flash.

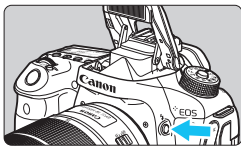

1 Press the button to raise the built-in flash.

- For wireless flash shooting, be sure to raise the built-in flash.

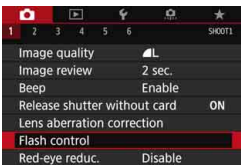

2 Select [Flash control].

- Under the  [1] tab, select [Flash control].

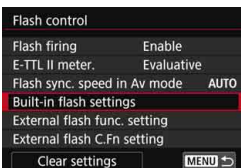

3 Select [Built-in flash settings].

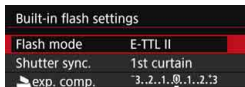

4 Set [Flash mode: E-TTL II].

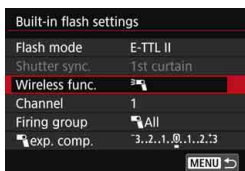

5 Set [Wireless func.] to [Wireless icon].

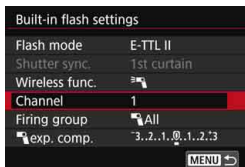

6 Set [Channel].

- Set the transmission channel (1-4) to the same one as the slave unit.

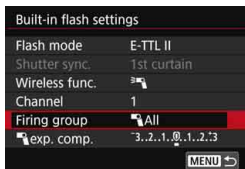

7 Set [Firing group] to [All].

8 Take the picture.

- Set the camera and take the picture in the same way as with normal flash shooting.
- To terminate wireless flash shooting, set [Wireless func.] to [Disable].



- Setting [E-TTL II meter.] to [Evaluative] is recommended.
- Firing a test flash is not possible with the slave unit.

Fully Automatic Shooting with One External Speedlite and Built-in Flash

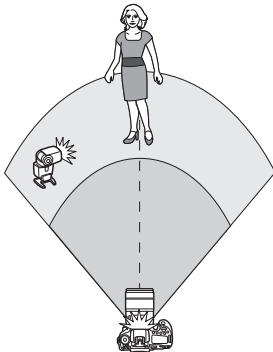

This is fully automatic wireless flash shooting with one external Speedlite and the built-in flash.

You can change the flash ratio between the external Speedlite and built-in flash to adjust how the shadows cast on the subject.

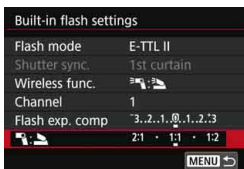
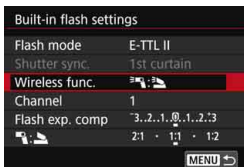

- If the built-in flash output is not enough, set a higher ISO speed (p.148).
- The 8:1 to 1:1 flash ratio is equivalent to 3:1 to 1:1 stops (1/2-stop increments).

Fully Automatic Shooting with Multiple External Speedlites

Multiple Speedlite slave units can be fired as one flash unit or separated into slave groups for shooting with flash ratio control.

The basic settings are shown below. By changing the **[Firing group]** setting, you can shoot with various wireless flash setups with multiple Speedlites.

Built-in flash settings	
Flash mode	E-TTL II
Shutter sync.	1st curtain
Wireless func.	☰
Channel	1
Firing group	☰ All
exp. comp.	-3..2..1..0..1..2..3

Basic settings:

Flash mode : E-TTL II

Wireless func. : ☰

Channel : (Same as slave units)

☰ [All] Firing multiple slave Speedlites as one flash unit

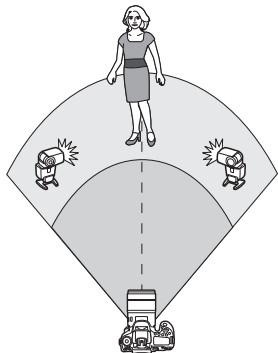

Effective when you need a large flash output. All the slave units will fire at the same output and be controlled to obtain a standard exposure.

No matter which firing group (A, B, or C) the slave units belong to, they will all fire as one group.

Built-in flash settings	
Flash mode	E-TTL II
Shutter sync.	1st curtain
Wireless func.	☰
Channel	1
Firing group	☰ All
exp. comp.	-3..2..1..0..1..2..3

1 Set **[Firing group]** to **[☰ All]**.

2 Take the picture.

- [ (A:B)] Firing multiple slave units in multiple groups

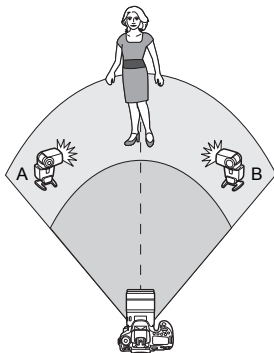

You can divide the slave units into groups A and B, and change the flash ratio to obtain the desired lighting effect. Refer to the Speedlite's instruction manual and set one slave unit to firing group A and the other to firing group B. Position the Speedlites as shown in the illustration.

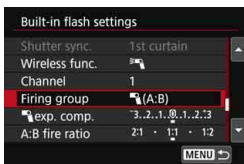

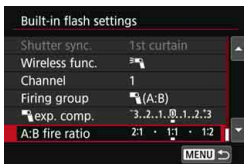

1 Set [Firing group] to [(A:B)].



2 Set the A:B flash ratio and shoot.

- Select [A:B fire ratio] and set the flash ratio.

 If [Firing group] is set to [ (A:B)], group C will not fire.

 The 8:1 to 1:1 to 1:8 flash ratio is equivalent to 3:1 to 1:1 to 1:3 stops (1/2-stop increments) for the exposure level.

Fully Automatic Shooting with the Built-in Flash and Multiple External Speedlites

The built-in flash can also be added to wireless flash shooting explained on pages 250-251.

The basic settings are shown below. By changing the **[Firing group]** setting, you can shoot with various wireless flash setups of multiple Speedlites complemented with the built-in flash.

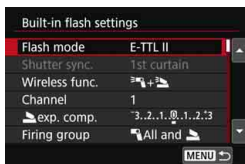

1 Basic settings:

Flash mode : E-TTL II

Wireless func. : [Icon]

Channel : (Same as slave units)

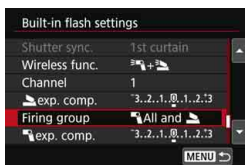

2 Set [Firing group].

- Select [[Icon] All and [Icon]] or [[Icon] (A:B) [Icon]].
- With [[Icon] (A:B) [Icon]], set the A:B flash ratio and shoot.

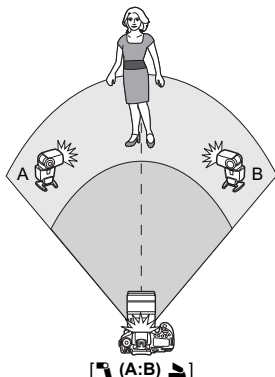
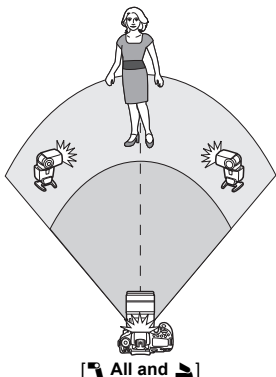

Creative Wireless Flash Shooting

● Flash exposure compensation

When [Flash mode] is set to [E-TTL II], flash exposure compensation can be set. The flash exposure compensation settings (see below) that can be set vary depending on the [Wireless func.] and [Firing group] settings.

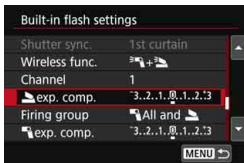

Flash exposure compensation

- The set amount of flash exposure compensation will be applied to the built-in flash and all the external Speedlites.

exp. comp.

- Flash exposure compensation is applied only to the built-in flash.

exp. comp.

- The set amount of flash exposure compensation will be applied to all the external Speedlites.

● FE lock

If [Flash mode] is set to [E-TTL II], you can press the <✳> button to perform FE lock (p.232).

Setting the Flash Output Manually for Wireless Flash Shooting

When **[Flash mode]** is set to **[Manual flash]**, flash exposure can be set manually. The flash output settings that can be set (**[Flash output]**, **[Group A output]**, etc.) vary depending on the **[Wireless func.]** setting (see below).

Built-in flash settings	
Flash mode	Manual flash
Shutter sync.	1st curtain
Wireless func.	
Channel	1
Firing group	All
flash output	1/4 . . 1/2 . . 1/1

Wireless func.:

- **Firing group: All**
The manual flash output setting is applied to all the external Speedlites.
- **Firing group: (A:B)**
You can set the flash output separately for slave groups A and B.

Wireless func.: +

- **Firing group: All and**
The flash output can be set separately for the external Speedlite(s) and built-in flash.
- **Firing group: (A:B)**
You can set the flash output separately for slave groups A and B. You can also set the flash output for the built-in flash.

7

Shooting with the LCD Monitor (Live View Shooting)

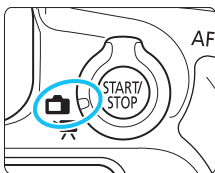

You can shoot while viewing the image on the camera's LCD monitor. This is called "Live View shooting".

Live View shooting is enabled by setting the Live View shooting/Movie shooting switch to .

- If you handhold the camera and shoot while viewing the LCD monitor, camera shake may cause blurred images. Using a tripod is recommended.



Remote Live View Shooting

With EOS Utility (EOS software, p.512) installed on your computer, you can connect the camera to the computer and shoot remotely while viewing the computer screen. For details, refer to the EOS Utility Instruction Manual.

Shooting with the LCD Monitor

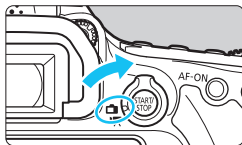

- 1** Set the Live View shooting/Movie shooting switch to .

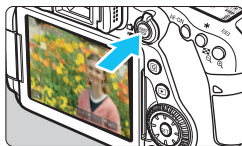

- 2** Display the Live View image.

- Press the  button.
- ▶ The Live View image will appear on the LCD monitor.
- The Live View image will be displayed in the brightness level closely matching that of the actual image to be captured.



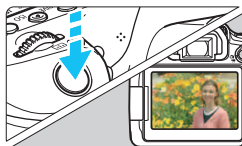

- 3** Focus on the subject.

- When you press the shutter button halfway, the camera will focus with the current AF method (p.276).
- You can also tap on the screen to select the face or subject (p.286).



- 4** Take the picture.

- Press the shutter button completely.
- ▶ The picture is taken and the captured image is displayed on the LCD monitor.
- ▶ When the playback display ends, the camera will return to Live View shooting automatically.
- Press the  button to exit the Live View shooting.

-  ● The image's field of view is approx. 100% (with the image-recording quality set to JPEG ).
- In Creative Zone modes, you can check the depth of field by pressing the depth-of-field preview button.
- You can also use a remote controller (sold separately, p.221) for Live View shooting.

Enabling Live View Shooting

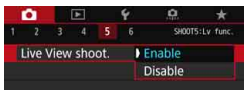

Set [**5: Live View shoot.**] (the [**5**] tab in Basic Zone modes) to [**Enable**].

Number of Possible Shots with Live View Shooting (Approx. number of shots)

Temperature	Room Temperature (23°C / 73°F)	Low Temperatures (0°C / 32°F)
No Flash	340	310
50% Flash Use	300	270

- The figures above are based on a fully-charged Battery Pack LP-E6N and CIPA (Camera & Imaging Products Association) testing standards.
- With a fully-charged Battery Pack LP-E6N, continuous Live View shooting is possible for approx. 2 hr. 30 min. at room temperature (23°C / 73°F).



- In the <SCN: > mode, Live View shooting is not possible.
- In the <SCN: > modes and <C: > modes, the shooting range will be smaller.
- When the flash is recycling, “BUSY” is displayed on the LCD monitor, and you cannot view the subject. Also, the continuous shooting speed will decrease.
- Do not point the camera toward an intense light source, such as the sun or an intense artificial light source. Doing so may damage the image sensor or the camera’s internal components.
- **General Live View Shooting Cautions are on pages 290-291.**



- You can also focus by pressing the <AF-ON> button.
- When flash is used, there will be two shutter sounds, but only one shot will be taken. Also, the time it takes to capture an image after you press the shutter button completely will be slightly longer than with viewfinder shooting.
- If the camera is not operated for a prolonged period, the power will turn off automatically after the time set in [**2: Auto power off**] (p.66). If [**2: Auto power off**] is set to [**Disable**], Live View shooting will end automatically after approx. 30 min. (camera power remains on).
- With the HDMI cable HTC-100, you can display the Live View image on a TV set (p.373). Note that no sound will be output. If the picture does not appear on the TV screen, check if the [**3: Video system**] is correctly set to [**For NTSC**] or [**For PAL**] (depending on the video system of your TV set).





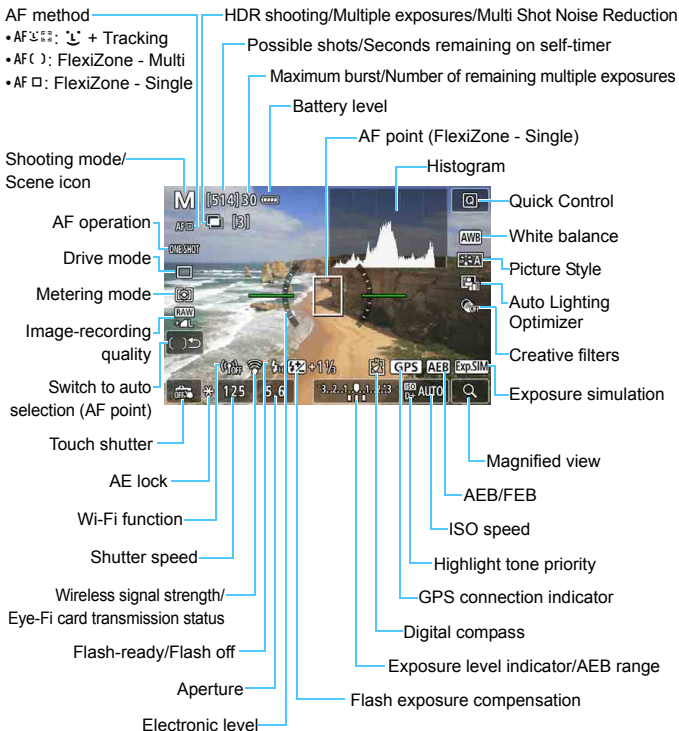



Information Display

- Each time you press the <INFO.> button, the information display will change.



You can edit what to display when the <INFO.> button is pressed (p.262).



- The histogram can be displayed by pressing the <INFO.> button when [ **5: Expo. simulation: Enable**] (p.271) is set. However, the histogram is not displayed while pressing the shutter button completely.
- You can display the electronic level by pressing the <INFO.> button (p.72). Note that if the AF method is set to [ **+Tracking**] or the camera is connected to a TV set with an HDMI cable, the electronic level cannot be displayed.
- When <Exp.SIM> is displayed in white, it indicates that the Live View image is displayed at the brightness level closely matching that of the actual image captured.
- If <Exp.SIM> is blinking, it indicates that the Live View image is displayed at a brightness that differs from the actual shooting result because of low-or bright-light conditions. However, the actual image recorded will reflect the exposure setting. Note that noise may be more noticeable than the actual image recorded.
- When the <SCN:   > mode is set, shooting with flash in Basic Zone modes, or [**Expo. simulation: Enable**] in Creative Zone modes is set and Multi Shot Noise Reduction, HDR mode, bulb exposure, or flash is used, exposure simulation will not be performed (p.271). <Exp.SIM> icon and histogram will be displayed in gray. The image will be displayed on the LCD monitor at the standard brightness. The histogram may not be properly displayed in low- or bright-light conditions.
- Exposure simulation is not performed in < :    > modes. <Exp.SIM> icon will be displayed in gray. The histogram will not be displayed.



Do not hold the camera in the same position for long periods of time.

Even if the camera does not feel too hot, prolonged contact with the same body part may cause skin redness or blistering due to low-temperature contact burns. Using a tripod is recommended for people with circulation problems or very sensitive skin, or when using the camera in very hot places.

Scene Icons

In the $\langle \text{A}^+ \rangle$ shooting mode, the camera will detect the scene type and set all the settings automatically to suit the scene. The detected scene type is indicated on the upper left of the screen. For certain scenes or shooting conditions, the icon displayed may not match the actual scene.

Subject Background	Portrait ^{*1}		Non-Portrait			Background Color
		Movement	Nature and Outdoor Scene	Movement	Close ^{*2}	
Bright						Gray
Backlit						
Blue Sky Included						Light blue
Backlit						
Sunset	*3			*3		Orange
Spotlight						Dark blue
Dark						
With Tripod	*4*5	*3	*4*5	*3		

*1: Displayed only when the AF method is set to $\langle \text{A}^+ \text{Tracking} \rangle$. If another AF method is set, the “Non-portrait” icon will be displayed even if a person is detected.

*2: Displayed when the attached lens has distance information. With an Extension Tube or Close-up Lens, the icon displayed may not match the actual scene.

*3: The icon of the scene selected from the detectable scenes will be displayed.

*4: Displayed when all the following conditions apply:

The shooting scene is dark, it is a night scene, and the camera is mounted on a tripod.

*5: Displayed with any of the lenses below:

- EF-S18-55mm f/3.5-5.6 IS II
- EF-S55-250mm f/4-5.6 IS II
- EF300mm f/2.8L IS II USM
- EF400mm f/2.8L IS II USM
- EF500mm f/4L IS II USM
- EF600mm f/4L IS II USM
- Image Stabilizer lenses released in and after 2012.

*4+*5: If the conditions in both *4 and *5 are met, the shutter speed will slow down.

Final Image Simulation

Final image simulation is a function that shows the Live View image as it will look with the current settings for Picture Style, white balance, and other shooting functions applied.

During shooting, the Live View image will automatically reflect the function settings listed below. However, it may be slightly different from the resulting image.

Final Image Simulation During Live View Shooting

- Picture Style
 - * Sharpness (Strength), contrast, color saturation, and color tone will be reflected.
- White balance
- White balance correction
- Ambience-based shots
- Lighting/scene based shots
- Background blur (in <[A]> mode)
 - * You can check the effect only during the setting procedure (when **[Simulating blur]** is displayed).
- Color tone (in <[P]> mode)
- Metering mode
- Exposure (with [**5: Expo. simulation: Enable**] set)
- Depth of field (with depth-of-field preview button ON)
- Auto Lighting Optimizer
- Peripheral illumination correction
- Chromatic aberration correction
- Highlight tone priority
- Aspect ratio (shooting range confirmation)

INFO. Button Display Options

You can change what is displayed when the <INFO.> button is pressed during Live View shooting or movie shooting.

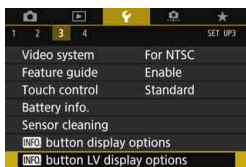

1 Select [**INFO**] button LV display options].

- Under the [**INFO**] tab, select [**INFO**] button LV display options], then press <SET>.

• Live View info switch setting

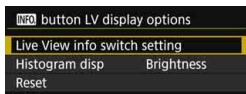

1 Select [Live View info switch setting].



2 Select a number.

- The numbers represent the number of times to press the <INFO.> button.
- Select a number for the displayed content you want to change, then press the <INFO.> button.
- You can also remove the [✓] mark from a number. However, you cannot remove the [✓] mark for all the numbers.

The default settings are shown below.

		1	2	3	4
	Basic shooting info	<input type="radio"/>	<input type="radio"/>	<input type="radio"/>	-
	Detailed shooting info	-	<input type="radio"/>	<input type="radio"/>	-
	On-screen buttons	<input type="radio"/>	<input type="radio"/>	<input type="radio"/>	-
	Histogram	-	-	<input type="radio"/>	-
	Electronic level	-	-	<input type="radio"/>	-



3 Edit the options.

- Select what you want to display and press <SET> to add a checkmark [✓].
- For what you do not want to display, press <SET> to remove the checkmark [✓].
- After completing the settings, select [OK].
- Repeat steps 2 and 3 as necessary.

• Histogram display

• Brightness/RGB

You can switch the histogram display between [Brightness] and [RGB] (p.352).

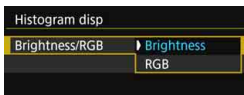

Set with [Brightness/RGB] in [Histogram disp].

• Display size

You can change the display size of the histogram.



Set with [Display size] in [Histogram disp].

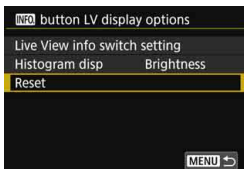

• Reset









To revert to the default settings (p.262), select [Reset], then select [OK].

Shooting Function Settings

AF / DRIVE / ISO / Settings

When the Live View image is displayed, if you press the <AF>, <DRIVE>, <ISO>, or <> button, the setting screen will appear on the LCD monitor and you can turn the <> or <> dial to set the respective shooting function.

 With Live View shooting, you cannot set <S> or <S> for the drive mode. In addition, the continuous shooting settings set with viewfinder shooting will not be maintained with Live View shooting.

 When you set  (Partial metering) or  (Spot metering), a circle indicating the metering area will be displayed at the center of the screen.

Q Quick Control

In Creative Zone modes, you can set the following: **AF method**, AF operation, **Drive mode**, Metering mode, **Image quality**, White balance, Picture Style, Auto Lighting Optimizer, and Creative filters.

In Basic Zone modes, you can set the functions shown in the table on page 107 (except background blur) as well as the functions in bold above.



1 Press the <Q> button (10).

- ▶ The settable functions will be displayed.

2 Select a function and set it.

- Press the <▲> <▼> keys to select a function.
- ▶ The settings of the selected function and Feature guide (p.75) will appear.
- Press the <◀> <▶> keys to set the function.
- In the <SCN> and <G> modes, select the shooting mode option on the upper left of the screen, then press <SET> to select the shooting mode.
- To set Auto white balance, select [AWB], then press <SET>.
- To set the RAW image quality, WB correction/WB bracketing, Picture Style parameters, or Creative filter effects, press the <INFO.> button.
- Press <SET> to return to Live View shooting.
- You can also select [↶] to return to Live View shooting.



With [Servo AF] (p.275), the image quality can be set to **RAW** or JPEG. If **M RAW** or **S RAW** is set, the image will be recorded in **RAW** quality.

Applying Creative Filters ☆

While viewing the Live View image, you can apply one of seven filter effects (Grainy B/W, Soft focus, Fish-eye effect, Art bold effect, Water painting effect, Toy camera effect, and Miniature effect) for shooting. The camera saves only the image with the Creative filter applied. You can also take a picture without a Creative filter, then apply an effect afterward and save it as a new image (p.399).

1 Turn the Mode Dial to a Creative Zone mode.

2 Press the <Q> button (10).

▶ The Quick Control screen will appear.

3 Select [OFF].

- Press the <▲> <▼> keys to select [OFF] (Creative filter) on the right side of the screen.



4 Select a filter.

- Press the <◀> <▶> keys to select a filter (p.268).
- ▶ The image will be displayed with the effects of the filter applied.
- For the Miniature effect, press the <▲> <▼> keys to move the white frame to where you want the image to look sharp.



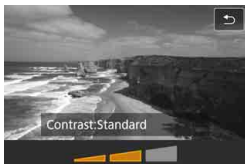

5 Adjust the filter effect.

- Press the <INFO.> button (except for )
- Press the <◀> <▶> keys to adjust the filter effect, then press <SET>.

6 Take the picture.

- ▶ The image is shot with the filter effect applied.







When you set a Creative filter, single shooting will take effect even if the drive mode is set to <□H> or <□>.



- You cannot shoot with Creative filters if the recording quality is RAW or RAW+JPEG, or if AEB, white balance bracketing, or Multi Shot Noise Reduction is set.
- The histogram is not displayed when you shoot with Creative filters.

Creative Filter Characteristics

-  **Grainy B/W**
Creates a grainy black-and-white photo. You can change the black-and-white effect by adjusting the contrast.
-  **Soft focus**
Gives the image a soft look. You can change the degree of softness by adjusting the blur.
-  **Fish-eye effect**
Gives the effect of a fish-eye lens. The image will have a barrel-type distortion.
Depending on the level of this filter effect, the area trimmed along the periphery of the image changes. Also, since this filter expands the center part of the image, the resolution at the center may decrease depending on the number of recorded pixels. Check the image on the screen when setting this filter. The AF method will be FlexiZone - Single (fixed at center).
-  **Art bold effect**
Makes the photo look like an oil painting and the subject look more three-dimensional. You can adjust the contrast and saturation. Note that subjects such as the sky or white walls may not be rendered with a smooth gradation and may look irregular or noise will become more noticeable.
-  **Water painting effect**
Makes the photo look like a watercolor painting with soft colors. You can control the color density by adjusting the filter effect. Note that some scenes including night scenes or low-light scenes may not be rendered with a smooth gradation and may look irregular or noise will become more noticeable.

-  **Toy camera effect**

Darkens the photo's corners and applies a unique color tone that makes it look as if it was shot by a toy camera. You can change the color cast by adjusting the color tone.

-  **Miniature effect**

Creates a diorama effect. You can change where the image looks sharp. In step 4, if you press the <@> button (or tap [] on the screen), you can switch between the white frame's vertical and horizontal orientations. The AF method will be FlexiZone - Single to focus at the center of the white frame.





- With Grainy B/W, the grainy effect displayed on the LCD monitor will look different from the grainy effect recorded in the picture.
- With the Soft focus and Miniature effect, the blurred effect displayed on the LCD monitor may look different from the blurred effect recorded in the picture. You can check the picture's blurred effect by pressing the depth-of-field preview button.

MENU Menu Function Settings

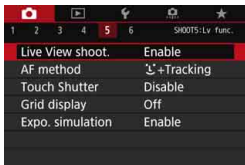
5



When the Live View shooting/Movie shooting switch is set to , menu options exclusive to the Live View shooting will appear under the [5] and [6] tabs (the [3] tab in Basic Zone modes).

The settable functions on this menu screen apply only to Live View shooting. They do not work with viewfinder shooting (settings are disabled).

● Live View shooting

You can set Live View shooting to [**Enable**] or [**Disable**].



● AF method

You can select [**L+Tracking**], [**FlexiZone - Multi**], or [**FlexiZone - Single**]. See pages 276-285 for more about the AF method.

● Touch shutter

Just by tapping on the LCD monitor screen, you can focus and take the picture automatically. For details, see page 286.

● Grid display

With [**3x3** ] or [**6x4** ], you can display grid lines to help you level the camera vertically or horizontally. Also, with [**3x3+diag** ], the grid is displayed together with diagonal lines to help you compose with better balance by aligning the intersections over the subject.

- **Exposure simulation** ☆

Exposure simulation simulates and displays how the brightness (exposure) of the actual image will look.

- **Enable** (Exp.SIM)

The displayed image brightness will be close to the actual brightness (exposure) of the resulting image. If you set exposure compensation, the image brightness will change accordingly.

- **During**  (DISP / Exp.SIM)

Normally, the image is displayed at the standard brightness to make the Live View image easy to see (DISP). The image will be displayed with a brightness (exposure) close to that of the actual image to be captured only while you hold down the depth-of-field preview button (Exp.SIM).

- **Disable** (DISP)

The image is displayed at the standard brightness to make the Live View image easy to see. Even if you set exposure compensation, the image is displayed at the standard brightness.

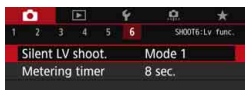

● Silent LV shooting ☆

• Mode 1

When shooting, you can suppress the mechanical sound more than with viewfinder shooting. Continuous shooting is also possible. If $\langle \text{H} \rangle$ is set, you can shoot at a maximum continuous shooting speed of approx. 7.0 fps.

• Mode 2

When the shutter button is pressed completely, only one shot will be taken. While you are holding down the shutter button, the camera operation will be suspended. Then when you return to the shutter button's halfway position, the camera operation will resume. The shooting noise is thereby minimized. Even if continuous shooting is set, only a single shot will be taken.

• Disable

Be sure to set it to **[Disable]** if you use a TS-E lens (other than those listed in ) **for shifting or tilting the lens** or if you use an Extension Tube. If **[Mode 1]** or **[Mode 2]** is set, the standard exposure may not be obtained, or an irregular exposure may result.

- Between **[Mode 1]** and **[Disable]**, the internal operation alone is different between the single drive mode and the first shot during continuous shooting. Continuous shooting with **[Mode 1]** will have the same mechanical sound as the **[Disable]** setting for the second and subsequent shots.
- When shooting with flash, the **[Disable]** setting will be applied regardless of the **[Silent LV shoot.]** setting. (You cannot suppress the mechanical sound when shooting.)
- When using a non-Canon flash unit, set it to **[Disable]**. The flash will not fire if it is set to **[Mode 1]** or **[Mode 2]**.
- If **[Mode 2]** is set and you use a Remote Controller (p.221), the operation will be the same as with **[Mode 1]**.



With the TS-E17mm f/4L or TS-E24mm f/3.5L II lens, you can use **[Mode 1]** or **[Mode 2]**.

● **Metering timer**[☆]

You can change how long the exposure setting is displayed (AE lock time).



Selecting any of the following menu items will stop Live View shooting. To start Live View shooting again, press the **< START/STOP >** button.

- **[CAM3: Dust Delete Data]**, **[F3: Sensor cleaning]**, **[F4: Clear all camera settings]**, or **[F4: CAM firmware ver.]**.

Selecting the AF Operation [☆]

You can select the AF operation characteristics to suit the shooting conditions or subject. In Basic Zone modes, the optimum AF operation is set automatically for the respective shooting mode.

1 Press the <AF> button.



2 Select the AF operation.

- Press the <◀> <▶> keys to select the desired AF operation, then press <SET>.

ONE SHOT: One-Shot AF

SERVO: Servo AF

If focus cannot be achieved, the AF point will turn orange. If this occurs, the picture cannot be taken even if the shutter button is pressed completely. Recompose the shot and try to focus again. Or see “Shooting Conditions that Make Focusing Difficult” (p.284).

One-Shot AF for Still Subjects

Suited for still subjects. When you press the shutter button halfway, the camera will focus only once.

- When focus is achieved, the AF point will turn green and the beeper will sound.
- While you hold down the shutter button halfway, the focus will be locked. You can then recompose the shot if desired.

If [📷1: Beep] is set to [Disable], the beeper will not sound when focus is achieved.

Servo AF for Moving Subjects

This AF operation is suited for moving subjects. While you hold down the shutter button halfway, the camera will keep focusing on the subject continuously.

- If the drive mode is set to high-speed continuous shooting, the maximum speed will be approx. 5.0 fps. The pictures will be taken with priority given to the continuous shooting speed.
- If the drive mode is set to low-speed continuous shooting, the maximum speed will be approx. 3.0 fps. The pictures will be taken with priority given to subject tracking.
- For flash photography, the continuous shooting speed will become slower.
- When focus is achieved, the AF point will turn blue. The beeper will not sound in this case.
- The exposure is set at the moment the picture is taken.
- Depending on the lens used, the distance to the subject, and the subject's speed, the camera may not be able to achieve correct focus.
- If you operate the zoom during continuous shooting, the focus may be lost. Shoot after using the zoom to obtain the desired composition.



- With [Servo AF], the image quality can be set to **RAW** or JPEG. If **M RAW** or **S RAW** is set, the image will be recorded in **RAW** quality.
- When [Servo AF] is set and Multi Shot Noise Reduction is set, [High ISO speed NR] will automatically switch to [Standard].

Focusing with AF (AF Method)

Selecting the AF Method

You can select an AF method to suit the shooting conditions and your subject. The following AF methods are provided: [**L**] (**face**)+Tracking] (p.277), [**FlexiZone - Multi**] (p.279), and [**FlexiZone - Single**] (p.281). If you want to achieve precise focus, set the lens's focus mode switch to **<MF>**, magnify the image, and focus manually (p.288).



1 Press the **<AF>** button.

2 Select the AF method.

- Turn the  dial to select the AF method, then press **<SET>**.

- You can also set the AF method with [**5: AF method**] (the [**3**] tab in Basic Zone modes).
- The procedures on pages 277-282 assume that One-Shot AF is set. If Servo AF is set, the AF point will turn blue when focus is achieved. The beeper will not sound in this case (p.274).
- In the **<SCN: >** modes, Servo AF is set automatically and when focus is achieved, the AF point will turn blue and the beeper will sound.

☺ (face)+Tracking: AF ☺

The camera detects and focuses on human faces. If a face moves, the AF point <☺> also moves to track the face.

1 Display the Live View image.

- Press the <START/STOP> button.
- ▶ The Live View image will appear on the LCD monitor.



Area frame

2 Check the AF point.

- When a face is detected, the area frame and the <☺> frame will appear on the face for focusing.
- If multiple faces are detected, <☺> will be displayed. Use the <☺> to move the <☺> frame over the face you want to focus on.
- You can also tap on the LCD monitor screen to select the face or subject. If the subject is not a face, <☺> will be displayed.

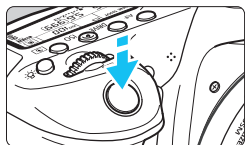

3 Focus on the subject.

- Press the shutter button halfway to focus.
- ▶ If no faces can be detected or if you do not tap on the LCD monitor, the camera will switch to FlexiZone - Multi with automatic selection (p.279).
- ▶ When focus is achieved, the AF point will turn green and the beeper will sound.
- ▶ If focus is not achieved, the AF point will turn orange.

4 Take the picture.

- Check the focus and exposure, then press the shutter button completely to take the picture (p.256).



- **Focusing on a subject other than a human face**

Press <SET> or <☒> and the AF frame <AF> will appear at the screen's center. Then use <⬅➡> to move the AF frame over the desired subject. Once the AF frame <AF> achieves focus, it will track the subject even if the subject moves or if you change the composition.

- If the subject's face is significantly out of focus, face detection will not be possible. Adjust the focus manually (p.288) so that the face can be detected, then perform AF.
 - An object other than a human face may be detected as a face.
 - Face detection will not work if the face is very small or large in the picture, too bright or too dark, or partially hidden.
 - The <AF> may cover only a part of the face.

- Use the area frame as a guide, and focus within the area frame.
- The size of the AF frame changes depending on the subject.

FlexiZone - Multi: AF ()

You can use up to 35 AF points for wide-area focusing (automatic selection). This wide area can also be divided into 9 zones for focusing (zone selection).



Area frame

1 Display the Live View image.

- Press the $\langle \text{START/STOP} \rangle$ button.
- ▶ The Live View image will appear on the LCD monitor.



2 Select the AF point. ☆

- Pressing $\langle \text{SET} \rangle$ or the $\langle \text{trash} \rangle$ button will toggle between automatic selection and zone selection. In Basic Zone modes, automatic selection is set automatically.
- Use $\langle \text{zone} \rangle$ to select the zone. To return to the center zone, press $\langle \text{SET} \rangle$ or the $\langle \text{trash} \rangle$ button again.
- You can also tap on the LCD monitor screen to select a zone. When a zone is selected, tap $[\text{zone}]$ on the screen to switch to automatic selection.

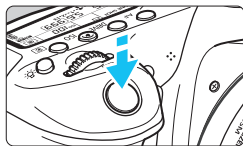

3 Focus on the subject.

- Aim the AF point over the subject and press the shutter button halfway.
- ▶ When focus is achieved, the AF point will turn green and the beeper will sound.
- ▶ If focus is not achieved, the area frame will turn orange.



4 Take the picture.

- Check the focus and exposure, then press the shutter button completely to take the picture (p.256).

- If the camera does not focus on the desired target subject with automatic AF point selection, select a zone or switch the AF method to **[FlexiZone - Single]** and refocus.
- The number of AF points varies, depending on the **[4: Aspect ratio]** setting. At **[3:2]**, there are 35 AF points. At **[4:3]** and **[1:1]**, there are 25 AF points. And at **[16:9]**, 21 AF points. Also, at **[16:9]**, there are three zones.
- For movie shooting, there are 21 AF points and three zones.

FlexiZone - Single: AF □

The camera focuses with a single AF point. This is effective when you want to focus on a particular subject.



AF point

1 Display the Live View image.

- Press the < START/STOP > button.
- ▶ The Live View image will appear on the LCD monitor.
- ▶ The AF point < □ > will appear.
- During movie shooting, if [Movie Servo AF] is set to [Enable], the AF point will be displayed in a larger size.



2 Move the AF point.

- Use < ⌂ > to move the AF point to where you want to focus. (It cannot be moved to the edge of the screen.)
- Pressing < SET > or the < ⌂ > button will return the AF point to the screen's center.
- You can also tap on the LCD monitor screen to move the AF point.

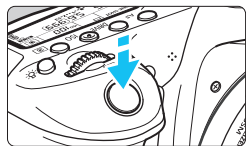

3 Focus on the subject.

- Aim the AF point over the subject and press the shutter button halfway.
- ▶ When focus is achieved, the AF point will turn green and the beeper will sound.
- ▶ If focus is not achieved, the AF point will turn orange.

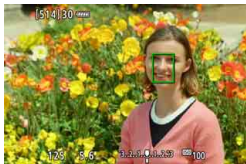

4 Take the picture.

- Check the focus and exposure, then press the shutter button completely to take the picture (p.256).

Notes for AF

AF Operation

- Even when focus is achieved, pressing the shutter button halfway will focus again.
- The image brightness may change during and after the AF operation.
- Depending on the subject or shooting conditions, etc., focusing may take longer or the continuous shooting speed may become slower.
- If the light source changes while the Live View image is displayed, the screen may flicker and focusing may be difficult. If this happens, exit Live View shooting and perform AF under the actual light source under which you are shooting.

Magnified View

- If [**L** + **Tracking**] is set, magnified view is not possible.
- When [**FlexiZone - Multi**] is set and you press the <Q> button (or tap <Q> on the screen), the center of the selected zone (or image center with automatic selection) will be magnified. If you press the shutter button halfway, the display will return to normal and the camera will focus.
- When [**FlexiZone - Single**] is set and you press the <Q> button (or tap <Q> on the screen), the area covered by the AF point will be magnified. Press the shutter button halfway to focus in the magnified view. This is effective when the camera is attached to a tripod and you need to attain very precise focus. If focusing is difficult in magnified view, return to the normal display and use AF. Note that the AF speed differs between the normal and magnified views.
- If you magnify the view after focusing with [**FlexiZone - Multi**] or [**FlexiZone - Single**] in the normal view, precise focus may not be achieved.
- In Servo AF mode, when you press the shutter button halfway in the magnified view, the display will return to normal and the camera will focus.

Shooting Conditions that Make Focusing Difficult

- Low-contrast subjects such as the blue sky, solid-color flat surfaces or when highlight or shadow details are lost.
- Subjects in low light.
- Stripes and other patterns where there is contrast only in the horizontal direction.
- Subjects with repetitive patterns (Example: Skyscraper windows, computer keyboards, etc.).
- Fine lines and subject outlines.
- Under a light source whose brightness, color, or pattern keeps changing.
- Night scenes or points of light.
- The image flickers under fluorescent or LED lighting.
- Extremely small subjects.
- Subjects at the edge of the picture.
- Strongly backlit or reflective subjects (Example: Cars with highly reflective bodies, etc.).
- The AF point covers both near and distant subjects (Example: Animal in a cage, etc.).
- Subjects that keep moving within the AF point and cannot keep still due to camera shake or subject blur.
- Performing AF when the subject is very far out of focus.
- Soft focus effect is applied with a soft focus lens.
- A special effect filter is used.
- Noise (dots of light, banding, etc.) appears on the screen during AF.



- If focus is not achieved with the shooting conditions listed on the preceding page, set the lens's focus mode switch to **<MF>** and focus manually.
- Depending on the lens used, focusing may take longer or correct focus may not be achieved. For details, refer to the Canon Web site.



- If you shoot a peripheral subject and it is slightly out of focus, aim the center AF point or zone over the subject to focus, focus again and then take the picture.
- The AF-assist beam will not be emitted. However, if an EX-series Speedlite (sold separately) equipped with an LED light is used, the LED light will turn on for AF-assist when necessary.
- In magnified view, achieving focus becomes more difficult due to camera shake. Using a tripod is recommended.

Shooting with the Touch Shutter

Just by tapping on the LCD monitor screen, you can focus and take the picture automatically. This works in all shooting modes.

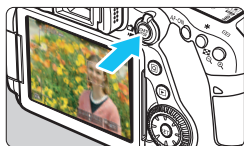





1 Display the Live View image.

- Press the <START/STOP> button.
- ▶ The Live View image will appear on the LCD monitor.







2 Enable the touch shutter.



- Tap [>] on the screen's bottom left. Each time you tap on the icon, it will toggle between [>] and [>].
- [>] (Touch shutter: Enable)
You can tap on the spot to focus and shoot.
- [>] (Touch shutter: Disable)
You can tap on a spot to perform focusing on where you want to focus. Press the shutter button completely to take the picture.



3 Tap on the screen to shoot.

- Tap on the face or subject on the screen.
- ▶ On the point you tap, the camera will focus with the AF method that was set (p.276-282).
- ▶ When focus is achieved, the AF point turns green and the picture is taken automatically.
- If focus is not achieved, the AF point turns orange and the picture cannot be taken. Tap on the face or subject on the screen again.

- Even if you set the drive mode to or , the camera will still shoot in single shooting mode.
- When you tap on the screen, focusing will be performed with One-Shot AF regardless of the [: **Touch shutter**] or [**AF operation**] settings.
- The touch shutter does not work with the magnified view.
- If the Fish-eye effect Creative filter is set, the camera will focus using the AF point at the center of the screen regardless of the point you tap on.
- If the Miniature effect Creative filter is set, the touch shutter does not work.
- If [**FlexiZone - Multi**] and [ **Touch shutter: Disable**] are set with a Basic Zone mode, focusing cannot be performed by tapping on the screen.
- When [ **Shutter butt. half-press**] is set to [**Metering start**] or [**AE lock (while button pressed)**] under [ **C.Fn III-4: Custom Controls**], autofocusing does not take effect.

- You can also set the touch shutter with [ **5: Touch Shutter**] (the [ **3**] tab in Basic Zone modes).
- To shoot with bulb exposure, tap on the screen twice. The first tap on the screen will start the bulb exposure. Tapping it again will stop the exposure. Be careful not to shake the camera when tapping on the screen.

MF: Focusing Manually

You can magnify the image and focus precisely with manual focus.

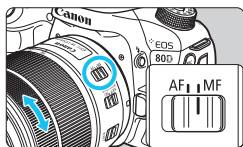

1 Set the lens's focus mode switch to <MF>.

- Turn the lens focusing ring to focus roughly.

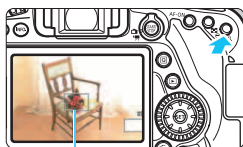

2 Display the magnifying frame.

- Press the <Q> button.
- ▶ The magnifying frame will appear.
- You can also tap [Q] on the screen to magnify the image.

Magnifying frame

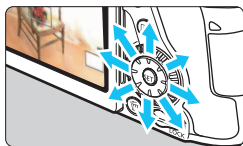

3 Move the magnifying frame.

- Use <⬇️> to move the magnifying frame to the position where you want to focus. You can also tap it to move it.
- Pressing <SET> or <🗑️> button will return the magnifying frame to the screen's center.

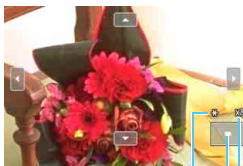

AE lock

Magnified area position

Magnification (Approx.)

4 Magnify the image.

- Each time you press the <Q> button, the magnification of the image will change in the following sequence:

→ Normal view → 1x → 5x → 10x →

- While in magnified view, you can use <⬆️> or tap the directional wedges displayed on the top, bottom, left, and right of the screen to scroll around the magnified image.

5 Focus manually.

- While looking at the magnified image, turn the lens focusing ring to focus.
- After achieving focus, press the <Q> button to return to the normal view.

6 Take the picture.

- Check the exposure, then press the shutter button completely to take the picture (p.256).



In magnified view, the exposure is locked. (Shutter speed and aperture will be displayed in red.)

General Live View Shooting Cautions

Image Quality

- When you shoot at high ISO speeds, noise (such as dots of light and banding) may become noticeable.
- Shooting in high temperatures may cause noise and irregular colors in the image.
- If Live View shooting is used continuously for a prolonged period, the camera's internal temperature may rise, and image quality may deteriorate. Always exit Live View shooting when you are not shooting.
- If you shoot a long exposure while the camera's internal temperature is high, image quality may deteriorate. Exit Live View shooting and wait a few minutes before shooting again.

White and Red Internal Temperature Warning Icons

- If the camera's internal temperature increases due to prolonged Live View shooting or under a high ambient temperature, a white or red icon will appear.
- The white icon indicates that the image quality of still photos will deteriorate. It is recommended that you temporarily exit Live View shooting and allow the camera to cool down before shooting again.
- The red icon indicates that the Live View shooting will soon stop automatically. If this happens, you will not be able to shoot again until the camera's internal temperature decreases. Exit the Live View shooting or turn off the power and let the camera rest for a while.
- Using Live View shooting at a high temperature for a prolonged period will cause the or icon to appear earlier. When you are not shooting, always turn off the camera.
- If the camera's internal temperature is high, the quality of images shot with high ISO speed or long exposure may deteriorate even before the white icon is displayed.

Shooting Results

- In magnified view, the shutter speed and aperture will be displayed in red. If you take the picture in magnified view, the exposure may not come out as desired. Return to the normal view before taking the picture.
- Even if you take the picture in magnified view, the image area for the normal view will be captured.



General Live View Shooting Cautions

Live View Image

- Under low- or bright-light conditions, the Live View image may not reflect the brightness of the captured image.
- Even if a low ISO speed is set, noise may be noticeable in the displayed Live View image under low light. However, when you shoot, the image recorded will have less noise. (The image quality of the Live View image is different from that of the recorded image.)
- If the light source (illumination) within the image changes, the screen may flicker. If this happens, exit Live View shooting and resume Live View shooting under the actual light source.
- If you point the camera in a different direction, it may throw off the Live View image's correct brightness momentarily. Wait until the brightness level stabilizes before shooting.
- If there is a very bright light source in the image, the bright area may appear black on the LCD monitor. However, the actual captured image will correctly show the bright area.
- In low light, if you set the [**F2: LCD brightness**] to a bright setting, noise or irregular colors may appear in the Live View image. However, the noise or irregular colors will not be recorded in the captured image.
- When you magnify the image, the image sharpness may look more pronounced than in the actual image.

Custom Functions

- During Live View shooting, certain Custom Function settings will not take effect (p.411).

Lens and Flash

- If the attached lens has an Image Stabilizer and you set the Image Stabilizer (IS) switch to <ON>, the Image Stabilizer will operate at all times even if you do not press the shutter button halfway. The Image Stabilizer consumes battery power and may decrease the number of possible shots depending on the shooting conditions. When the Image Stabilizer is not necessary, such as when using a tripod, it is recommended to set the IS switch to <OFF>.
- The focus preset function is possible for Live View shooting only when using a (super) telephoto lens equipped with the focus preset mode released in and after the second half of 2011.
- FE lock will not work if the built-in flash is used. FE lock and modeling flash will not work if an external Speedlite is used.

8

Shooting Movies

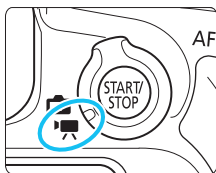

Movie shooting is enabled by setting the Live View shooting/Movie shooting switch to <  >.

- For cards that can record movies, see page 5.
- If you handhold the camera and shoot movies, camera shake can cause blurred movies. Using a tripod is recommended in such cases.



Full HD 1080

Full HD 1080 indicates compatibility with High-Definition featuring 1080 vertical pixels (scanning lines).



Shooting Movies

Autoexposure Shooting

Autoexposure control will take effect to suit the scene's current brightness.

1 Set the Mode Dial to a mode other than <M> and <M>.

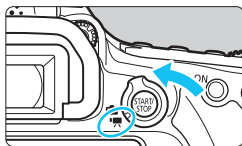

2 Set the Live View shooting/Movie shooting switch to <M>.

- ▶ The reflex mirror will make a sound, then the image will appear on the LCD monitor.

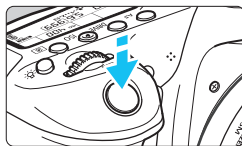

3 Focus on the subject.

- Before shooting a movie, focus with AF or manual focus (p.276-285, 288).
- When you press the shutter button halfway, the camera will focus with the current AF method.

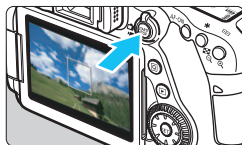

4 Shoot the movie.

- Press the <START/STOP> button to start shooting a movie.
- ▶ While the movie is being shot, the [●] mark will be displayed on the upper right of the screen.
- ▶ Sound will be recorded by the built-in microphones.
- To stop shooting the movie, press the <START/STOP> button again.

Recording movie



Microphones



- In Basic Zone modes, the shooting result will be the same as with $\langle \text{A}^+ \rangle$. Also, the scene icon for the scene detected by the camera is displayed on the upper left (p.297).
- In the $\langle \text{Tv} \rangle$, $\langle \text{Av} \rangle$, and $\langle \text{B} \rangle$ shooting modes, the settings will be the same as when shooting in the $\langle \text{P} \rangle$ mode.
- Settable menu functions differ between Basic Zone modes and Creative Zone modes (p.477).
- In Creative Zone modes, you can press the $\langle * \rangle$ button (p.203) to lock the exposure (AE lock). After applying AE lock during movie shooting, you can cancel it by pressing the $\langle \text{AE-L} \rangle$ button. (AE lock setting is retained until you press the $\langle \text{AE-L} \rangle$ button.)
- In Creative Zone modes, you can set the $\langle \text{LOCK} \rangle$ switch downward and turn the $\langle \text{DIAL} \rangle$ dial to set the exposure compensation.
- If you shoot a movie with autoexposure, the ISO speed, shutter speed, and aperture will not be recorded in the movie's Exif information.
- With autoexposure (modes other than **M**) movie shooting, the camera will automatically turn on the Speedlite's LED light under low-light conditions. For details, refer to the instruction manual of an EX-series Speedlite equipped with an LED light.

ISO Speed in Basic Zone Modes

- The ISO speed will be set automatically within ISO 100 - ISO 12800.

ISO Speed in the P, Tv, Av, and B Modes

- The ISO speed will be set automatically within ISO 100 - ISO 12800.
- In **[Range for movies]** under **[📷2: ISO speed settings]**, if you set **[Maximum]** to **[H(25600)]**, the automatic setting range will be expanded to H (equivalent to ISO 25600). Even if you set **[Minimum]** to ISO 200 or higher and **[Maximum]** to ISO 3200 or lower, the range will be set within ISO 100 - ISO 6400 automatically (p.332).
- If **[📷3: Highlight tone priority]** is set to **[Enable]** (p.174), the ISO speed will be ISO 200 - ISO 12800.
- Under **[📷2: ISO speed settings]**, **[Auto range]** and **[Min. shutter spd.]** cannot be set (p.152-153) for movie shooting.

- 🗨️
 - Since shooting a movie at ISO 16000 may result in much noise, it is designated as an expanded ISO speed (displayed as "H").
 - When switching from still photo shooting to movie shooting, check the ISO speed settings before shooting movies.

Scene Icons

During movie shooting in a Basic Zone mode (except the mode), an icon representing the scene detected by the camera will be displayed, and the shooting will be performed to suit the scene. For certain scenes or shooting conditions, the icon displayed may not match the actual scene.

Subject Background		Portrait* ¹	Non-Portrait		Background Color
			Nature and Outdoor Scene	Close* ²	
Bright					Gray
	Backlit				
Blue Sky Included					Light blue
	Backlit				
Sunset		* ³		* ³	Orange
Spotlight					Dark blue
Dark					

*1: Displayed only when the AF method is set to [+Tracking]. If another AF method is set, the “Non-portrait” icon will be displayed even if a person is detected.

*2: Displayed when the attached lens has distance information. With an Extension Tube or Close-up Lens, the icon displayed may not match the actual scene.

*3: The icon of the scene selected from the detectable scenes will be displayed.

Manual Exposure Shooting

You can manually set the shutter speed, aperture, and ISO speed for movie shooting. Using manual exposure to shoot movies is for advanced users.



1 Set the Mode Dial to <M>.

2 Set the Live View shooting/Movie shooting switch to <Movie>.

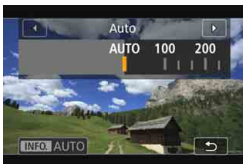

3 Set the ISO speed.

- Press the <ISO> button.
- ▶ The ISO speed setting screen will appear on the LCD monitor.
- Turn the <ISO> dial to set the ISO speed.
- For details on the ISO speed, see the next page.

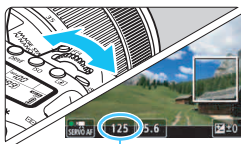

Shutter speed

4 Set the shutter speed and aperture.

- Press the shutter button halfway and check the exposure level indicator.
- To set the shutter speed, turn the <Shutter> dial. The settable shutter speeds vary depending on the frame rate.
 - **25.00P** **23.98P** : 1/4000 sec. - 1/25 sec.
 - **29.97P** : 1/4000 sec. - 1/30 sec.
 - **50.00P** : 1/4000 sec. - 1/50 sec.
 - **59.94P** : 1/4000 sec. - 1/60 sec.
- To set the aperture, turn the <Aperture> dial.
- If it cannot be set, set the <LOCK> switch downward, then turn the <Aperture> or <Shutter> dial.

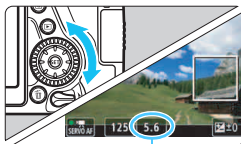

Aperture

5 Focus and shoot the movie.

- The procedure is the same as steps 3 and 4 for “Autoexposure Shooting” (p.294).

ISO Speed During Manual Exposure Shooting

- With **[Auto] (A)**, the ISO speed will be set automatically within ISO 100 - ISO 12800. In **[Range for movies]** under **[CAM2: ISO speed settings]**, if you set **[Maximum]** to **[H(25600)]**, the automatic setting range will be expanded to H (equivalent to ISO 25600). Even if you set **[Minimum]** to ISO 200 or higher and **[Maximum]** to ISO 3200 or lower, the range will be set within ISO 100 - ISO 6400 automatically (p.332).
- You can set the ISO speed manually within ISO 100 - ISO 12800 in 1/3-stop increments. In **[Range for movies]** under **[CAM2: ISO speed settings]**, if you set **[Maximum]** to **[H(25600)]**, the automatic setting range will be expanded to H (equivalent to ISO 25600) (p.332).
- If **[CAM3: Highlight tone priority]** is set to **[Enable]** (p.174), the ISO speed will be ISO 200 - ISO 12800.
- Under **[CAM2: ISO speed settings]**, **[Auto range]** and **[Min. shutter spd.]** (p.152-153) cannot be set for movie shooting.



- Since shooting a movie at ISO 16000 may result in much noise, it is designated as an expanded ISO speed (displayed as "H").
- When switching from still photo shooting to movie shooting, check the ISO speed settings before shooting movies.
- Changing the shutter speed or aperture during movie shooting is not recommended since the changes in the exposure will be recorded.
- When shooting a movie of a moving subject, a shutter speed within approx. 1/30 sec. to 1/125 sec. is recommended. The faster the shutter speed, the less smooth the subject's movement will look.
- If you change the shutter speed while shooting under fluorescent or LED lighting, image flicker may be recorded.



- Under **[C.FnIII-4: Custom Controls]**, if **[SET: Expo comp (hold btn, turn  is set (p.438), you can set exposure compensation while ISO Auto is set.**
- When ISO Auto is set, you can press the **<★>** button to lock the ISO speed.
- If you press the **<★>** button and recompose the shot, you can see the exposure level difference on the exposure level indicator (p.300) compared to when the **<★>** button is pressed.
- By pressing the **<INFO.>** button, you can display the histogram.

Information Display

- Each time you press the <INFO.> button, the information display will change.

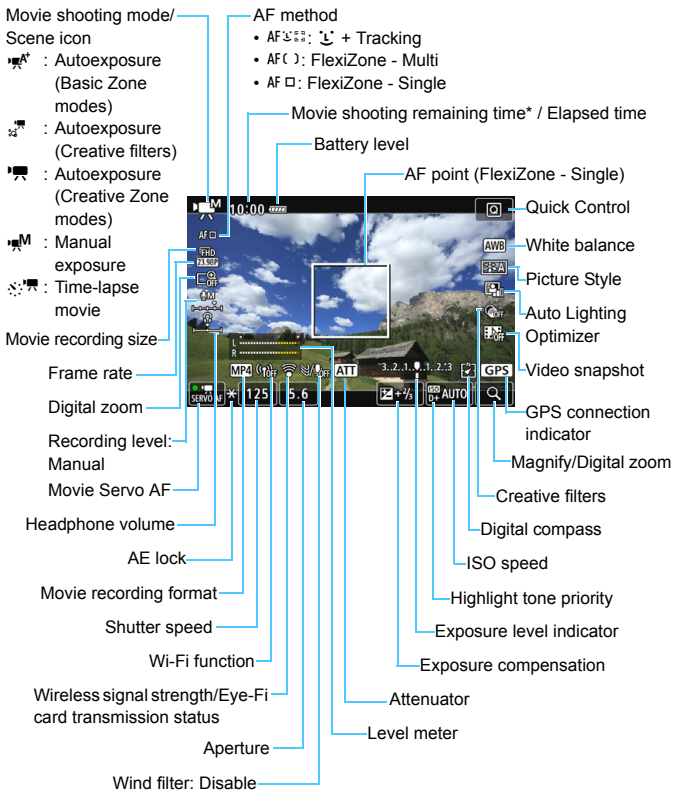

* Applies to a single movie clip.



- You can display the electronic level by pressing the <INFO.> button (p.72).
- You can edit what to display when the <INFO.> button is pressed (p.262).
- Note that if the AF method is set to [**☺ +Tracking**] or the camera is connected to a TV set with an HDMI cable (p.373), the electronic level cannot be displayed.
- The electronic level, grid lines, or histogram cannot be displayed during movie shooting. (The display will disappear when you start shooting a movie.)
- When movie shooting starts, the movie shooting remaining time will change to the elapsed time.

Final Image Simulation

Final image simulation is a function that shows the movie as it will look with the current settings for Picture Style, white balance and other shooting functions applied.

During movie shooting, the image displayed will automatically show the effects of the settings listed below.

Final Image Simulation for Movie Shooting

- Picture Style
 - * Sharpness (Strength), contrast, color saturation, and color tone will be reflected.
- White balance
- White balance correction
- Exposure
- Depth of field (except during time-lapse movie shooting)
- Auto Lighting Optimizer
- Peripheral illumination correction
- Chromatic aberration correction
- Highlight tone priority
- HDR movie
- Creative filters

Still Photo Shooting

Still photo shooting is not possible during movie shooting. To shoot still photos, stop shooting the movie and perform viewfinder shooting or Live View shooting.

🔊 Cautions for Movie Shooting

- Do not point the camera toward an intense light source, such as the sun or an intense artificial light source. Doing so may damage the image sensor or the camera's internal components.
- When you press the shutter button halfway to autofocus during movie shooting, the following phenomena may occur.
 - Focus may become far off momentarily.
 - The brightness of the recorded movie may change.
 - The recorded movie may be momentarily still.
 - The movie may record the lens mechanical sound.
- If <AWB> or <AWB w> is set and the ISO speed or aperture changes during movie shooting, the white balance may also change.
- If you shoot a movie under fluorescent or LED lighting, the movie may flicker.
- Shooting a few test movies is recommended where you will perform zooming during movie shooting. Zooming during movie shooting may result in recording of changes in exposure or mechanical sound of the lens, or images may be out of focus.
- During movie shooting, you cannot magnify the image even if you press the <Q> button.
- Be careful not to cover the built-in microphones (p.294) with your finger, etc.
- If you connect or disconnect the HDMI cable during movie shooting, the movie shooting will end.
- **General Movie Shooting Cautions are on pages 343-344.**
- **If necessary, also read General Live View Shooting Cautions on pages 290-291.**

🔊 **Do not hold the camera in the same position for long periods of time.** Even if the camera does not feel too hot, prolonged contact with the same body part may cause skin redness or blistering due to low-temperature contact burns. Using a tripod is recommended for people with circulation problems or very sensitive skin, or when using the camera in very hot places.





Notes for Movie Shooting

- Movie-related settings are under the [📷4] and [📷5] tabs (p.326). (In Basic Zone modes, they are under the [📷2] and [📷3] tabs.)
- A movie file is recorded each time you shoot a movie. If the file size exceeds 4 GB, a new file will be created for every subsequent 4 GB (p.309).
- The movie image's field of view is approx. 100% (with movie recording size set to [1920x1080]).
- You can also focus on the image by pressing the <AF-ON> button.
- Stereo sound is recorded by the camera's built-in microphones.
- Most external stereo microphones equipped with a 3.5 mm diameter mini plug can be used.
- With a fully-charged Battery Pack LP-E6N, the total movie shooting time will be as follows: approx. 1 hr. 50 min. at room temperature (23°C / 73°F) and approx. 1 hr. 40 min. at low temperatures (0°C / 32°F) (with [📷4: Movie Servo AF: Disable] set).
- The focus preset function is possible for movie shooting when using a (super) telephoto lens equipped with the focus preset mode, released in and after the second half of 2011.

Shooting Function Settings

AF / ISO Settings

If you press the <AF> button while the image is displayed on the LCD monitor, the setting screen will appear on the LCD monitor and you can turn the < > dial to set the AF method.

- During manual exposure shooting (p.298), you can press the <ISO> button to set the ISO speed.
- <DRIVE> drive mode and < > metering mode cannot be set.

Q Quick Control

In Creative Zone modes, the **AF method**, **Movie recording size**, **Digital zoom**, Recording level (set manually only), **Volume** (headphones), White balance, Picture Style, Auto Lighting Optimizer, Creative filters, and **Video snapshot** can be set.

In Basic Zone modes, only the functions in bold above can be set.



1 Press the <Q> button (◻10).

- ▶ The settable selected function will be displayed.
- **[HDR Movie Shooting]** is settable only in Basic Zone modes (p.314).

2 Select a function and set it.

- Press the <▲> <▼> keys to select a function.
- ▶ The settings of the selected function and Feature guide (p.75) will appear on the screen.
- Press the <◀> <▶> keys to set the function.
- To set Auto white balance, select **[AWB]**, then press <SET>.
- To set the WB correction, Picture Style parameters, or Creative filters, press the <INFO.> button.
- Pressing <SET> will return the camera to movie shooting.
- You can also select [**↶**] to return to movie shooting.

MENU Setting the Movie Recording Size



With [**4**: **Movie rec quality**] (the [**2**] tab in Basic Zone modes), you can set the movie recording format, movie recording size (image size, frame rate, and compression method), and other functions.

MOV/MP4

You can select the movie's recording format.

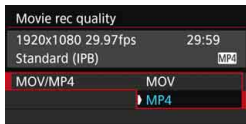

MOV MOV

The movie is recorded in the MOV format (file extension: “.MOV”).
Convenient for editing with a computer.

MP4 MP4

The movie is recorded in the MP4 format (file extension: “.MP4”). This format is compatible with a larger range of playback systems than the MOV format.

Movie Recording Size

You can select the movie's size, frame rate, and compression method.



- **Image Size**

- **FHD 1920x1080**

Full High-Definition (Full HD) recording quality. The aspect ratio is 16:9.

- **HD 1280x720**

High-Definition (HD) recording quality. The aspect ratio is 16:9.

- **Frame Rate** (fps: frames per second)

29.97P 29.97 fps / 59.94P 59.94 fps

For areas where the TV system is NTSC (North America, Japan, South Korea, Mexico, etc.).

25.00P 25.00 fps / 50.00P 50.00 fps

For areas where the TV system is PAL (Europe, Russia, China, Australia, etc.).

23.98P 23.98 fps

Mainly for motion pictures.



The frame rate displayed on the movie recording size screen switches depending on whether [▼ 3: Video system] is set to [For NTSC] or [For PAL] (p.475). **23.98P** (23.98 fps) can be selected only when [For NTSC] is set.

● **Compression Method**

Fixed at **[ALL-I]** if the recording format is MOV. For the MP4 format, **[IPB]** or **[IPB]**  can be selected.

• **In MOV Format**

[ALL-I] **ALL-I** (For editing/I-only)

Compresses one frame at a time for recording. Although the file size is larger than with IPB (Standard) and IPB (Light), the movie is better suited for editing.

• **In MP4 Format**

[IPB] **IPB** (Standard)

Compresses multiple frames at a time efficiently for recording.

[IPB]  **IPB** (Light)

Records a movie at a bit rate lower than with IPB (Standard), resulting in a smaller file size and compatibility with a larger range of playback systems.

 If you change the [**3: Video system**] setting, set the movie recording size again.

Total Movie Recording Time and File Size Per Minute

● In MOV Format (Approx.)

Movie Recording Quality					Total Recording Time on Card			File Size
					4 GB	16 GB	64 GB	
4K FHD	59.97P	25.00P	23.98P	ALL-I	5 min.	23 min.	1 hr. 33 min.	654 MB/min.

● In MP4 Format (Approx.)

Movie Recording Quality					Total Recording Time on Card			File Size
					4 GB	16 GB	64 GB	
4K FHD	59.94P	50.00P		IPB	8 min.	35 min.	2 hr. 21 min.	431 MB/min.
	29.97P	25.00P	23.98P	IPB	17 min.	1 hr. 10 min.	4 hr. 41 min.	216 MB/min.
	29.97P	25.00P		IPB	43 min.	2 hr. 53 min.	11 hr. 35 min.	87 MB/min.
4K HD	59.94P	50.00P		IPB	20 min.	1 hr. 21 min.	5 hr. 24 min.	184 MB/min.
	29.97P	25.00P		IPB	2 hr. 5 min.	8 hr. 20 min.	33 hr. 22 min.	30 MB/min.
HDR Movie Shooting					17 min.	1 hr. 10 min.	4 hr. 41 min.	216 MB/min.

● Movie Files Exceeding 4 GB

Even if you shoot a movie exceeding 4 GB, you can keep shooting without interruption.

During movie shooting, if the file size exceeds 4 GB, a new movie file will be created automatically.

When you play back the movie, you will have to play each movie file individually. Movie files cannot be played back automatically in consecutive order. After the movie playback ends, select the next movie to be played back.



- An increase of the camera's internal temperature may cause movie shooting to stop before the maximum recording time shown in the table (p.343).
- If the file size exceeds 4 GB during movie shooting, "buSY" may be displayed on the LCD panel for a while.

- **Movie Shooting Time Limit**

The maximum recording time of one movie clip is 29 min. 59 sec. If the movie shooting time reaches 29 min. 59 sec., the movie shooting will stop automatically. You can start shooting a movie again by pressing the < $\frac{\text{START}}{\text{STOP}}$ > button. (The movie will be recorded as a new movie file.)

MENU Using Movie Digital Zoom

When the recording size is **FHD 29.97P/23.98P** (NTSC) or **FHD 25.00P** (PAL), you can shoot with an approx. 3x to 10x digital zoom (except in **<Q>** mode).

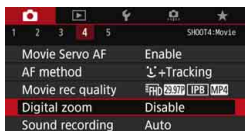

1 Select [Digital zoom].

- Under the [**4**] tab (the [**2**] tab in Basic Zone modes), select [**Digital zoom**] and press **<SET>**.



2 Select [Approx. 3-10x zoom].

- Select [**Approx. 3-10x zoom**], then press **<SET>**.
- Press the **<MENU>** button to exit the menu and return to movie shooting.



3 Use digital zoom.

- Press the **<▲>** **<▼>** keys.
- ▶ The digital zoom bar will appear.
- Press the **<▲>** key to zoom in or press the **<▼>** key to zoom out.
- When you press the shutter button halfway, the camera will focus with [**FlexiZone - Single**] (fixed at center).
- To cancel digital zoom, set [**Disable**] in step 2.



- Use a tripod to prevent camera shake.
- When movie digital zoom is set, the maximum ISO speed will be ISO 6400.
- Since movie digital zoom processes the image digitally, the image will look grainier at higher magnifications. Noise, dots of light, etc., may also become noticeable.
- When movie digital zoom is set, the scene icon will not be displayed.
- Also see "Shooting Conditions that Make Focusing Difficult" on page 284.

MENU Setting the Sound Recording

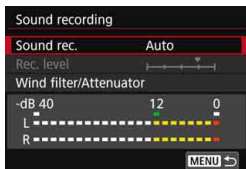

You can shoot movies while recording sound with the built-in stereo microphones or a commercially-available external stereo microphone. You can also freely adjust the sound-recording level.

Set the sound recording with [**4**: **Sound recording**].

Sound Recording/Sound-Recording Level

[Auto] : The sound-recording level is adjusted automatically. Auto level control will operate automatically in response to the sound level.

[Manual] : For advanced users. You can adjust the sound-recording level to one of 64 levels.

Select [**Rec. level**] and turn the <⦿> dial while looking at the level meter to adjust the sound-recording level. Look at the peak hold indicator, and adjust so that the level meter sometimes lights up on the right of the “12” (-12 dB) mark for the loudest sounds. If it exceeds “0”, the sound will be distorted.

[Disable] : Sound will not be recorded.

Wind Filter/Attenuator

[Wind filter] : When set to **[Auto]**, it reduces wind noise when there is wind outdoors. This feature takes effect only with the built-in microphones. When the wind filter function takes effect, low bass sounds will also be reduced.

[Attenuator] : Automatically suppresses sound distortion caused by loud noises. Even if you set [**Sound recording**] to **[Auto]** or **[Manual]** before shooting, sound distortion may still result if there is a very loud sound. In such a case, setting it to **[Enable]** is recommended.

● Using Microphones

Normally, the built-in microphones will record stereo sound. Stereo sound recording is also possible by connecting a commercially-available external stereo microphone equipped with a miniature stereo plug ($\phi 3.5$ mm) to the camera's external microphone IN terminal (p.26).

● Using Headphones

By connecting stereo headphones (commercially-available) equipped with a 3.5 mm diameter mini plug to the camera's headphone terminal (p.26), you can listen to the sound during movie shooting. To adjust the headphones' sound volume, press the $\langle \text{Q} \rangle$ button and select $\langle \text{Q} \rangle$. Then turn $\langle \text{Q} \rangle$ to adjust (p.305). You can also use headphones during movie playback.



- When using headphones for audio, noise reduction will not be applied to the headphone output. Because of this, what you hear will differ from the actual audio recorded with the movie.
- An external microphone may pick up noise while wireless functions are in use. Keep a distance between the camera and microphone.



- In Basic Zone modes, the settings available for **[Q2: Sound recording]** will be **[On/Off]**. If **[On]** is set, the sound-recording level will be adjusted automatically (same as with **[Auto]**), and the wind filter function will take effect.
- The sound volume balance between L (left) and R (right) cannot be adjusted.
- Audio is recorded at a 48 kHz/16-bit sampling rate.

Shooting HDR Movies

You can shoot movies by reducing the clipped highlight details of bright areas even in high-contrast scenes. This function is settable in Basic Zone modes (except the $\langle \text{Q} \rangle$ mode).

HDR movie can be set when the MP4 format is set and the recording size is $\text{FHD } 29.97\text{P}$ IPB (NTSC) or $\text{FHD } 25.00\text{P}$ IPB (PAL).

1 Set the Mode Dial to a Basic Zone mode.

2 Press the $\langle \text{Q} \rangle$ button (10).

▶ The Quick Control screen will appear.



3 Select [HDR_{OFF}].

- Press the $\langle \blacktriangle \rangle$ $\langle \blacktriangledown \rangle$ keys to select [HDR_{OFF}] (HDR Movie Shooting) on the screen's right side.



4 Select [Enable].

- For recording time and file sizes, see the table on page 309.





- Since multiple frames are merged to create an HDR movie, a part of the movie may be distorted. During shooting while handholding the camera, the distortion caused by camera shake may be more noticeable. Using a tripod is recommended. Note that even if a tripod is used for shooting, afterimages may be noticeable or noise may look increased when the HDR movie is played back frame-by-frame or in slow-motion compared to normal playback.
- HDR movie shooting cannot be set if movie digital zoom, video snapshot, or time-lapse movie is set.

Shooting Movies with Creative Filters

In the <C> (Creative filters) mode, you can shoot movies with one of five filter effects (Memory, Dream, Old Movies, Dramatic B&W, and Miniature effect movie).

The recording size can be set to $\overline{\text{FHD}}$ 29.97P / 23.98P (NTSC) or $\overline{\text{FHD}}$ 25.00P (PAL).



1 Set the Mode Dial to <C>.

2 Press the <Q> button (10).

▶ The Quick Control screen will appear.

3 Select [$\overline{\text{CF}}$].

- Press the <▲> <▼> keys to select [$\overline{\text{CF}}$] (Creative filters) on the upper left of the screen, then press <SET>.



4 Select a filter effect.

- Press the <▲> <▼> or <◀> <▶> keys to select a filter (p.317-318), then press <SET> and select [OK].
- ▶ The image will be displayed with the effects of the filter applied.
- For the Miniature effect movie, press the <▲> <▼> keys to move the white frame to where you want the image to look sharp.

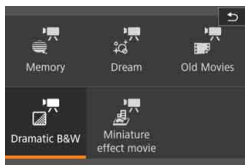



5 Adjust the filter effect level.

- Press the **[Q]** button and select the icon below [**Creative filters**].
- Press the **<◀>** **<▶>** keys to adjust the filter effect, then press **<SET>**.
- When the Miniature effect movie is set, select the playback speed.

6 Shoot the movie.



- Magnified view is not possible.
- The histogram is not displayed.
- It is not possible to set movie digital zoom, video snapshot, or time-lapse movie.



In Creative Zone modes, use the Quick Control to set a Creative filter (p.305).

Creative Filter Characteristics

● **Memory**

Creates the atmosphere of a distant memory. Gives the movie a soft look overall, reducing brightness of the periphery of the screen. You can modify the overall saturation and the dark areas along the screen edges by adjusting the filter effect.

● **Dream**

Creates a soft, dreamy, otherworldly atmosphere. Gives the movie a soft look overall, blurring the periphery of the screen. You can adjust the blurry areas along the screen edges.

● **Old Movies**

Creates an atmosphere like an old film by adding wavering, scratches, and flickering effects to the image. (The top and bottom of the screen are masked in black.) You can modify the wavering and scratch effects by adjusting the filter effect.

 **Dramatic B&W**

Creates an atmosphere of dramatic realism with high-contrast black and white. You can adjust the graininess and black-and-white effect.

 **Miniature effect movie**

You can shoot movies having a Miniature (diorama) effect. Select the playback speed and shoot. You can change where the image looks sharp. In step 4, if you press the <⌂> button (or tap [⌂] on the bottom right of the screen), you can switch between the white frame's vertical and horizontal orientations. In step 5, set the playback speed to [5x], [10x], or [20x] and shoot. The AF method will be FlexiZone - Single to focus on the center of the white frame. The white frame is not displayed during shooting.

Playback Speed and Length (for 1-minute movie)

Speed	Playback Length
5x	Approx. 12 sec.
10x	Approx. 6 sec.
20x	Approx. 3 sec.

 A smooth gradation of the color of the sky or white walls may not be reproduced. Irregular exposure, irregular colors, or noise may appear.

 **Miniature Effect Movies**

- Sound will not be recorded.
- Since sound will not be output during shooting, you cannot listen to the sound even if you connect headphones to the camera.
- Movie Servo AF will not function.
- Miniature effect movies whose playback time is shorter than 1 sec. cannot be edited (p.367).

Shooting Time-lapse Movies

Still photos shot at a set interval can be stitched together automatically to create a time-lapse movie. A time-lapse movie shows how a subject changes in a much shorter period of time than the actual time it took. It is effective for a fixed-point observation of changing scenery, growing plants, celestial motion, etc.

Time-lapse movies are recorded in the MOV format and in FHD 29.97P ALL-I (NTSC) or FHD 25.00P ALL-I (PAL) recording size.

1 Set the Mode Dial to a mode other than $\langle \text{Q} \rangle$.



2 Select [Time-lapse movie].

- Under the [Q 5] tab (the [Q 3] tab in Basic Zone modes), select [Time-lapse movie] and press $\langle \text{SET} \rangle$.

3 Select [Enable].

- Select [Enable], then press the $\langle \text{INFO.} \rangle$ button.

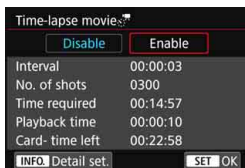

⚠ Do not point the camera toward an intense light source, such as the sun or an intense artificial light source. Doing so may damage the image sensor or the camera's internal components.

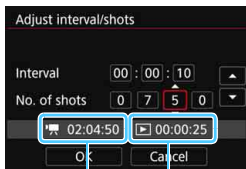

Time required

Playback time

4 Set the shooting interval and number of shots.

- Check the [: Time required] and [: Playback time] displayed at the bottom of the screen to set the shooting interval and number of shots.
- Select the number to be set (hours: minutes: seconds / number of shots).
- Press <SET> so < > is displayed.
- Set the desired number, then press <SET>. (Returns to < >.)

• Shooting interval

Settable from [00:00:01] to [99:59:59].

• Number of shots

Settable from [0002] to [3600]. Set one digit at a time. If 3600 is set, the time-lapse movie will be approx. 2 min. for NTSC and approx. 2 min. 24 sec. for PAL.

5 Select [OK].

- ▶ The screen for step 2 will reappear.

6 Check the settings.

- With [Time-lapse movie] selected on the screen in step 2, press <SET>.
- ▶ The current settings will be displayed.

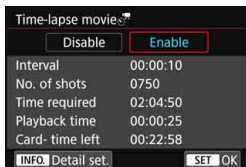

• Time required

Indicates the time required to shoot the set number of shots with the set interval. If it exceeds 24 hours, “*** days” will be displayed.

• Playback time

Indicates the movie recording time (time required to play back the movie) to create the time-lapse movie in (NTSC) or (PAL) from the still photos taken with the set intervals.

● **Card- time left**

The total length of a time-lapse movie that can be recorded on the card based on its remaining capacity.

7 Exit the menu.

- Press the <MENU> button to turn off the menu screen.

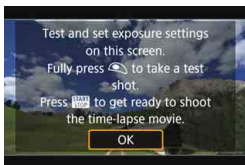

8 Read the message.

- Read the message and select [OK].

9 Take test shots.

- Set the exposure and shooting functions, and press the shutter button halfway to focus as you do with Live View shooting.
- Press the shutter button completely to start taking test shots. The test images will be recorded to the card.
- If there are no problems with the test shots, go to the next step.
- To take test shots again, repeat this step.



10 Press the <START/STOP> button.

- ▶ The camera will be ready to start shooting a time-lapse movie.
- To return to step 9, press the <START/STOP> button again.

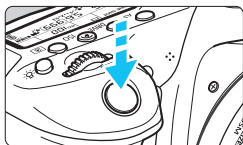

Shots remaining

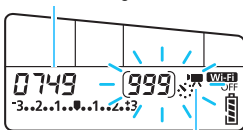

Time-lapse movie

11 Shoot the time-lapse movie.

- Press the shutter button halfway to check the focus and exposure.
- Press the shutter button completely to start shooting the time-lapse movie.
- AF will not work during time-lapse movie shooting. The exposure setting for the first shot will be applied to subsequent shots.
- During time-lapse movie shooting, nothing will be displayed on the LCD monitor. <START/STOP> will blink on the LCD panel.
- Since the electronic shutter is used for shooting, the reflex mirror and shutter make no mechanical sound during time-lapse movie shooting.
- When the set number of shots are taken, the time-lapse movie shooting will stop and be automatically canceled.

- Using a tripod is recommended.
- Taking test shots is recommended.
- To cancel the time-lapse movie shooting before it is completed, either press the shutter button completely or press the <START/STOP> button (**[Disable]** is set). The time-lapse movie shot so far will be recorded on the card.
- You can play back the shot time-lapse movie with this camera the same way that you play back normal movies.
- If the time required for shooting is more than 24 hours but not more than 48, “2 days” will be indicated. If three or more days are required, the number of days will be indicated in 24-hour increments.
- Even if the time-lapse movie's playback time is less than 1 sec., a movie file will still be created. For **[Playback time]**, “00:00:00” will be displayed.
- If the shooting time is long, using DC Coupler DR-E6 (sold separately) and AC Adapter AC-E6 (sold separately) is recommended.
- When shooting in Basic Zone modes, the scene icon for the scene detected by the camera is displayed on the upper left of the screen (p.260).



- With time-lapse movie set to [Enable], you cannot set [**Q4: Movie rec quality**] and [**F3: Video system**].
- Cannot be set when movie digital zoom is set.
- If the camera is connected to a computer with the interface cable, or if an HDMI cable is connected to the camera, you cannot select [Enable].
- The maximum ISO speed will be ISO 6400 in the <P>, <Tv>, <Av>, and modes, and in the <M> mode with ISO Auto set.
- If the shooting mode is <Av>, <Tv> or , the operation will be the same as the <P> mode.
- Movie Servo AF will not function.
- The shutter speed will be in the range from 1/4000 to 30 sec.
- If the shutter speed is 1/30 sec. or slower, the exposure of the movie may not be displayed properly (may differ from that of the resulting movie).
- Do not zoom the lens during time-lapse movie shooting. Zooming the lens may cause the image to be out of focus, the exposure to change, or the lens aberration correction not to function properly.
- When shooting a time-lapse movie under a flickering light, noticeable image flickering, horizontal stripes (noise), or irregular exposures may be recorded.
- The image displayed during time-lapse movie shooting and the resulting movie may look different (in terms of flicker, depth of field, etc.).
- If you move the camera from left to right (panning) or shoot a moving subject while shooting a time-lapse movie, the image may look extremely distorted.
- During time-lapse movie shooting, auto power off will not take effect. Also, you cannot adjust the shooting function and menu function settings, or play back images.
- Sound is not recorded for time-lapse movies.
- The shooting function settings for the first shot will be applied to subsequent shots.
- If a long exposure or shutter speed longer than the shooting interval is set, the camera cannot shoot with the set interval. Also, shooting may not be performed when the shutter speed and the shooting interval are nearly the same.
- If the next scheduled shot is not possible, it will be skipped. This may make the time-lapse movie's recording time shorter.

- 
 - If the time it takes to record to the card exceeds the interval between shots due to the shooting functions set or card performance, shooting with the set interval may not be performed.
 - The captured images are not recorded as still photos. Even if you cancel the time-lapse movie shooting after only one shot is taken, it will be recorded as a movie file.
 - If the card does not have enough free space to record the set number of shots, **[Playback time]** will be displayed in red. Although the camera can continue shooting, the shooting will stop when the card becomes full.
 - If you connect the camera to a computer with the interface cable provided with the camera and use EOS Utility (EOS software), set **[CAMERA 5: Time-lapse movie]** to **[Disable]**. If it is set to **[Enable]**, the camera cannot communicate with the computer.
 - During time-lapse movie shooting, the lens's Image Stabilizer will not operate.
 - If the power switch is set to <OFF> or the Live View shooting/Movie shooting switch is operated, time-lapse movie shooting will be terminated and the setting is switched to **[Disable]**.
 - Even if a flash is used, it will not fire.
 - Shooting-ready state of the time-lapse movie is canceled and the setting is switched to **[Disable]** with any of the following operations:
 - Selecting **[CAMERA 3: Dust Delete Data]**, **[FUNCTION 3: Sensor cleaning]**, **[FUNCTION 4: Clear all camera settings]**, or **[FUNCTION 4: Firmware ver.]**.
 - Selecting <**Q**> or <**Q2**> shooting modes.
 - When time-lapse movie shooting ends, the settings are cleared automatically, and the camera returns to normal movie shooting. Note that if you have set the shutter speed slower than 1/60 sec. for time-lapse movie shooting and the settings are automatically cleared, the shutter speed may be automatically changed to a speed within the settable range for normal movie shooting.
 - If you start time-lapse movie shooting while the white <**W**> (p.343) is displayed, the image quality of the time-lapse movie may deteriorate.



You can perform time-lapse movie shooting with a fully-charged Battery Pack LP-E6N for the approximate durations (from start of shooting until the battery is exhausted) listed in the table below. Possible time for time-lapse movie shooting will vary depending on the shooting conditions.

Approximate Total Possible Time for Time-lapse Movie Shooting (Approx.)

	Room Temperature (23°C / 73°F)	Low Temperatures (0°C / 32°F)
Shooting interval: 1 sec.	3 hr. 50 min.	3 hr. 20 min.
Shooting interval: 10 sec.	5 hr.	4 hr. 30 min.



You can start or stop the time-lapse movie shooting using Remote Controller RC-6 (sold separately, p.221). Set [**5: Remote control**] to [**Enable**] beforehand.

When Using Remote Controller RC-6

Camera Status/ Remote Control Setting	<2> (2-sec. delay)	<●> (Immediate shooting)
Test-shooting screen	To shooting-ready	Shoots still photo
Shooting-ready	To test-shooting screen	Starts shooting
During time-lapse movie shooting	Ends shooting	Ends shooting

MENU Menu Function Settings

📷4

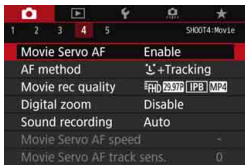

When the Live View shooting/Movie shooting switch is set to <📷>, the movie shooting menu options will appear under the [📷4] and [📷5] tabs (the [📷2] and [📷3] tabs in Basic Zone modes).

● Movie Servo AF

With this function enabled, the camera focuses on the subject continuously during movie shooting. The default setting is **[Enable]**.

When **[Enable]** is set:

- The camera focuses on the subject continuously even when you are not pressing the shutter button halfway.
- If you want to keep the focus at a specific point, or if you do not want the lens mechanical sound to be recorded, you can temporarily stop Movie Servo AF as follows. When you stop Movie Servo AF, the AF point will turn gray. When you perform the same steps below, Movie Servo AF will resume.
 - Tap the [SERVO AF] icon on the lower left of the screen.
 - Press the <⚡> button.
 - Under [**C.Fn III-4: Custom controls**], if a button is assigned with **[AF stop]**, you can pause the Movie Servo AF while holding down that button. When you let go of the button, Movie Servo AF will resume.
- While Movie Servo AF is paused, if you return to movie shooting after operations such as pressing the <MENU> or <▶> button, or changing the AF method, Movie Servo AF will resume.

When **[Disable]** is set:

- Press the shutter button halfway or press the <AF-ON> button to focus.

- **AF method**

The AF methods are the same as described on pages 276-285. You can select [+Tracking], [FlexiZone - Multi], or [FlexiZone - Single].



Cautions When [Movie Servo AF] is Set to [Enable]

- **Shooting Conditions that Make Focusing Difficult**
 - A fast-moving subject approaching or moving away from the camera.
 - A subject moving at a close distance in front of the camera.
 - Also see “Shooting Conditions that Make Focusing Difficult” on page 284.
- Since this drives the lens continuously, it will consume battery power and shorten the total possible movie shooting time (p.309).
- With certain lenses, the lens mechanical sound during focusing may be recorded. If this happens, use a commercially-available external microphone to reduce the lens mechanical sound in the movie. Also, using certain USM lenses (for example, the EF-S18-135mm f/3.5-5.6 IS USM) or certain STM lenses (for example, the EF-S18-55mm f/3.5-5.6 IS STM) will reduce the lens mechanical sound to be recorded.
- Movie Servo AF will pause during zooming or in magnified view.
- During movie shooting, if a subject approaches or moves away or if the camera is moved vertically or horizontally (panning), the recorded movie image may momentarily expand or contract (change in image magnification).
- If you want to set the lens's focus mode switch to <MF> during Movie Servo AF, first set the Live View shooting/Movie shooting switch to <>.

- **Movie recording quality**

You can set the movie recording format (MOV or MP4) and movie recording size. For details, see page 306.

- **Digital zoom**

You can use digital zoom for telephoto shooting. For details, see page 311.

- **Sound recording**

You can set the sound-recording functions. For details, see page 312.

● Movie Servo AF speed ☆

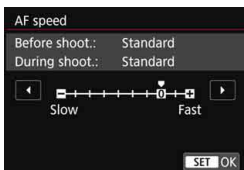
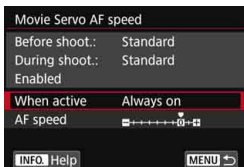

You can set the Movie Servo AF's AF speed and its operation conditions. This function is settable when **[Movie Servo AF]** is set to **[Enable]** and **[AF method]** is set to **[FlexiZone - Single]**. Additionally, the function is enabled when using a lens supporting slow focus transition during movie shooting*.

When active : **[Always on]** sets the AF adjustment speed to take effect at all times for movie shooting (before and during movie shooting). **[During shooting]** sets the AF adjustment speed to take effect only during movie shooting.

AF speed : You can adjust the AF speed (focus transition speed) from standard speed to slow (one of seven levels) or fast (one of two levels), to obtain the desired effect for movie creation.

* Lenses supporting slow focus transition during movie shooting

USM lenses released in and after 2009 (for example, the EF-S 18-135mm f/3.5-5.6 IS USM) and STM lenses (for example, the EF-S 18-55mm f/3.5-5.6 IS STM) support slow focus transition during movie shooting. For details, refer to the Canon Web site.

 If **[AF method]** is set to **[L+Tracking]** or **[FlexiZone - Multi]**, the operation will be the same as when **[AF speed]** is set to **[Standard (0)]**.

● Movie Servo AF tracking sensitivity ☆

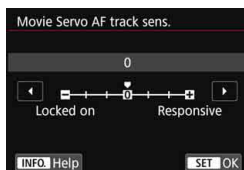

You can change the Movie Servo AF's tracking sensitivity to one of seven levels. This affects the responsiveness of AF tracking sensitivity when the AF points stray from the subject, such as during panning or when an obstacle cuts across the AF points.

This function is settable when **[Movie Servo AF]** is set to **[Enable]** and **[AF method]** is set to **[FlexiZone - Single]**.

Locked on: -3/-2/-1

This setting makes the camera less inclined to track a different subject if the AF point loses the original subject. The closer the setting is to the minus (-) symbol, the less the camera is inclined to track a different subject. It is effective when you want to prevent the AF points from rapidly tracking something that is not the intended subject during panning or when an obstacle cuts across the AF points.

Responsive: +1/+2/+3

This makes the camera more responsive when tracking a subject that covers the AF point. The closer the setting is to the plus (+) symbol, the more responsive the camera is. It is effective when you want to keep tracking a moving subject as its distance from the camera changes, or to rapidly focus on another subject.

 If **[AF method]** is set to **[$\overline{\text{L}}$ +Tracking]** or **[FlexiZone - Multi]**, the tracking sensitivity will be equivalent to the **[0]** setting.

5



- **Metering timer** ☆

You can change how long the exposure setting is displayed (AE lock time).

- **Grid display**

With [**3x3**] or [**6x4**], you can display grid lines to help you level the camera vertically or horizontally. Also, with [**3x3+diag**], the grid is displayed together with diagonal lines to help you compose with better balance by aligning the intersections over the subject.

- **button function**

You can set the functions performed by pressing the shutter button halfway or completely during movie shooting.

Setting	Pressed Halfway	Pressed Completely
AF/-	Metering and AF	No function (disabled)
/-	Metering only	No function (disabled)
/	Metering and AF	Starts/stops movie shooting
/	Metering only	Starts/stops movie shooting

If [/] or [/] is set, besides pressing the < > button, you can start/stop the movie shooting by pressing the shutter button completely or by using Remote Switch RS-60E3 (sold separately, p.221).



- Even if you set [**btn function**] to [/ -] or [/], AF will be performed when you press the shutter button halfway during time-lapse movie shooting.
- During movie shooting, the [**btn function**] setting overrides any function assigned to the shutter button with [**C.Fn III-4: Custom Controls**].

- **Video snapshot**

You can shoot video snapshots. For details, see page 333.

- **Time-lapse movie**

You can shoot time-lapse movies. For details, see page 319.

- **Remote control shooting**

When [Enable] is set, you can start or stop movie shooting using Remote Controller RC-6 (sold separately, p.221). [i] will be displayed on the LCD panel. Set the release mode switch to <2>, then press the transmit button. If the switch is set to <●> (immediate shooting), the [👁️ btn function] setting will be applied.

ISO Speed Menu During Movie Shooting

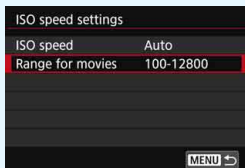

When the Live View shooting/Movie shooting switch is set to <📷>, the corresponding setting in [📷2: ISO speed settings] will change to [Range for movies].

MENU Shooting Video Snapshots

You can shoot a series of short movie clips lasting approx. 2 sec., 4 sec., or 8 sec. called video snapshots. The video snapshots can be joined together into a single movie called a video snapshot album. You can thereby show quick highlights of a trip or event.

A video snapshot album can also be played back together with background music (p.340, 372).

Video Snapshot Album Concept

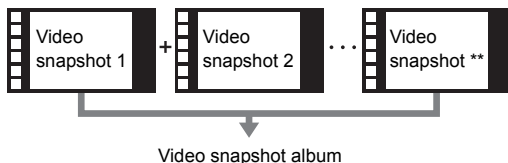

Setting the Video Snapshot Shooting Duration

1 Set the Mode Dial to a mode other than <M>.

2 Select [Video snapshot].

- Under the [M5] tab (the [M3] tab in Basic Zone modes), select [Video snapshot] and press <SET>.

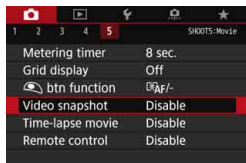

3 Select [Enable].

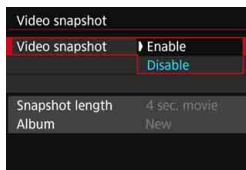

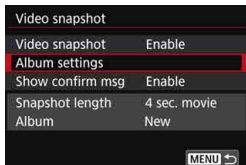

4 Select [Album settings].

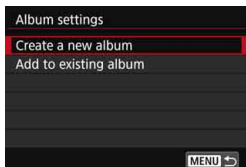

5 Select [Create a new album].

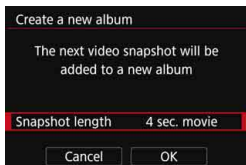

6 Select the snapshot length.

- Press <SET> and use the <▲> <▼> keys to select the snapshot's length, then press <SET>.



Shooting duration

7 Select [OK].

- Press the <MENU> button to exit the menu.
- ▶ A blue bar will appear to indicate the snapshot length.
- Go to "Creating a Video Snapshot Album" (p.335).

Creating a Video Snapshot Album



8 Shoot the first video snapshot.

- Press the <START/STOP> button, then shoot.
- ▶ The blue bar indicating the shooting duration will gradually decrease. After the set shooting duration elapses, the shooting stops automatically.
- ▶ The confirmation screen will appear (p.336-337).



9 Save as a video snapshot album.

- Select [**Save as album**], then press <SET>.
- ▶ The movie clip will be saved as the video snapshot album's first video snapshot.

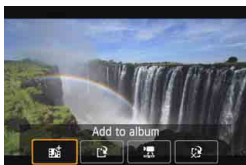

10 Continue to shoot more video snapshots.







- Repeat step 8 to shoot the next video snapshot.
- Select [**Add to album**], then press <SET>.
- To create another video snapshot album, select [**Save as a new album**].
- Repeat step 10 as necessary.



11 Exit the video snapshot shooting.

- Set [**Video snapshot**] to [**Disable**].
To return to normal movie shooting, be sure to set [Disable].
- Press the <MENU> button to exit the menu, and return to the normal movie shooting.

Options in Steps 9 and 10



















Function	Description
 Save as album (Step 9)	The movie clip will be saved as the video snapshot album's first video snapshot.
 Add to album (Step 10)	The video snapshot just recorded will be added to the album recorded immediately before.
 Save as a new album (Step 10)	A new video snapshot album is created and the movie clip is saved as the first video snapshot. The new album will be a different file from the previously recorded album.
 Playback video snapshot (Step 9 and 10)	The video snapshot just recorded will be played back. For playback operations, see the table on the next page.
 Do not save to album (Step 9)  Delete without saving to album (Step 10)	The video snapshot just recorded will be erased instead of being saved to the album. Select [OK] on the confirmation dialog.



Video snapshot	
Video snapshot	Enable
Album settings	
Show confirm msg	Disable
Snapshot length	4 sec. movie
Album	XXX - XXXX
MENU 	

If you want to shoot another video snapshot right after shooting one video snapshot, set **[Show confirm msg]** to **[Disable]**. This setting will allow you to immediately shoot the next video snapshot without the confirmation screen appearing after you shoot each time.

[Playback video snapshot] Operations in Steps 9 and 10

Function	Playback Description
 Play	By pressing <  >, you can play back or pause the video snapshot recorded immediately before.
 First frame	Displays the first scene of the album's first video snapshot.
 Skip backward*	Each time you press <  >, the video snapshot skips back by a few seconds.
 Previous frame	Each time you press <  >, the previous frame is displayed. If you hold down <  >, it will rewind the movie.
 Next frame	Each time you press <  >, the movie will play frame-by-frame. If you hold down <  >, it will fast forward the movie.
 Skip forward*	Each time you press <  >, the video snapshot skips forward by a few seconds.
 Last frame	Displays the last scene of the album's last video snapshot.
	Playback position
mm' ss"	Playback time (minutes:seconds)
 Volume	Turn the <  > dial to adjust the volume of the built-in speaker (p.365).
	Pressing the < MENU > button returns to the previous screen.

* With [**Skip backward**] and [**Skip forward**], the skipping length corresponds to the number of seconds set under [**Video snapshot**] (approx. 2 sec., 4 sec., or 8 sec.).

Adding to an Existing Album



1 Select [Add to existing album].

- Follow step 5 on page 334 to select [Add to existing album], then press < (SET) >.



2 Select an existing album.

- Turn the < (DIAL) > dial to select an existing album, then press < (SET) >.
- Select [OK], then press < (SET) >.
- ▶ Certain video snapshot settings will change to match the existing album's settings.
- Press the < MENU > button to exit the menu.
- ▶ The video snapshot shooting screen will appear.

3 Shoot the video snapshot.

- See "Creating a Video Snapshot Album" (p.335) to shoot the video snapshot.

! You cannot select an album shot with another camera.

Cautions for Shooting Video Snapshots

- When the MOV format is selected, video snapshot cannot be set.
- You can add to an album only video snapshots with the same duration (approx. 2 sec., 4 sec., or 8 sec. each).
- Note that if you do any of the following while shooting video snapshots, a new album will be created for subsequent video snapshots.
 - Changing the **[Movie rec. size]**.
 - Changing the **[Sound rec.]** setting from **[Auto]/[Manual]** to **[Disable]** or from **[Disable]** to **[Auto]/[Manual]**.
 - Updating the firmware.
- The shooting duration of a video snapshot is only approximate. Depending on the frame rate, the shooting duration displayed during playback may not be exact.

Playing back an Album

You can play back a video snapshot album in the same way as a normal movie (p.365).



1 Play back the movie.

- Press the <▶> button to display an image.



2 Select the album.

- In the single-image display, the [SET >] icon displayed on the upper left of the screen indicates a video snapshot album.
- Turn the <⦿> dial to select an album.



3 Play back the album.

- Press <Ⓢ>.
- On the movie playback panel displayed, select [▶] (Play), then press <Ⓢ>.



Background Music

- You can play background music when you play back albums, normal movies, and slide shows on the camera (p.366, 372). To play background music, you must first copy the background music to the card using EOS Utility (EOS software). For information on how to copy the background music, refer to the EOS Utility Instruction Manual.
- Music recorded on the memory card must be used only for private enjoyment. Do not violate the rights of the copyright holder.

Editing an Album

After shooting, you can rearrange, delete, or play back the video snapshots in the album.



1 Select [X].

- On the movie playback panel displayed, select [X] (Edit), then press <SET>.
- ▶ The editing screen will be displayed.



2 Select an editing operation.

- Select an editing option, then press <SET>.

Function	Description
↔ Move snapshot	Press the <◀> <▶> keys to select the video snapshot you want to move, then press <SET>. Press the <◀> <▶> keys to move the snapshot, then press <SET>.
🗑 Delete snapshot	Press the <◀> <▶> keys to select the video snapshot you want to delete, then press <SET>. The [🗑] icon will be displayed on the selected video snapshot. Pressing <SET> again will cancel the selection and [🗑] will disappear.
▶ Play snapshot	Press the <◀> <▶> keys to select the video snapshot you want to play, then press <SET>.



3 Save the edited album.

- Press the <MENU> button to return to the Editing panel at the screen's bottom.
- Select [**✓**] (Save), then press <SET>.
- ▶ The save screen will appear.
- To save it as a new album, select [**New file**]. To save it and overwrite the original album, select [**Overwrite**], then press <SET>.

- If the card does not have enough free space, [**New file**] will not be available.
- When the battery level is low, editing albums is not possible. Use a fully-charged battery.



General Movie Shooting Cautions

Red Internal Temperature Warning Icon

- If the camera's internal temperature increases due to prolonged movie shooting or under a high ambient temperature, a red icon will appear.
- The red icon indicates that movie shooting will soon be terminated automatically. If this happens, you will not be able to shoot again until the camera's internal temperature decreases. Turn off the power and let the camera rest for a while.
- Shooting a movie at a high temperature for a prolonged period will cause the icon to appear earlier. When you are not shooting, always turn off the camera.

Recording and Image Quality

- If the attached lens has an Image Stabilizer and you set the Image Stabilizer (IS) switch to <ON>, the Image Stabilizer will operate at all times even if you do not press the shutter button halfway. The Image Stabilizer consumes battery power and may shorten the total movie shooting time depending on the shooting conditions. If you use a tripod or if the Image Stabilizer is not necessary, it is recommended to set the IS switch to <OFF>.
- The camera's built-in microphones will also pick up the operation sound during shooting and mechanical sound of the camera. Use a commercially-available external microphone to reduce these sounds in the movie.
- Do not connect anything other than an external microphone to the camera's external microphone IN terminal.
- If the brightness changes during autoexposure movie shooting, the movie may freeze temporarily. In such a case, shoot movies with manual exposure.
- If there is a very bright light source in the image, the bright area may appear black on the LCD monitor. The movie will be recorded almost exactly as it appears on the LCD monitor.
- In low light, noise or irregular colors may appear in the image. The movie will be recorded almost exactly as it appears on the LCD monitor.
- If you play back a movie with other devices, image or sound quality may deteriorate or playback may not be possible (even if the devices support MOV/MP4 format).

General Movie Shooting Cautions

Recording and Image Quality

- If you use a card with a slow writing speed, a five-level indicator may appear on the right of the screen during movie shooting. It indicates how much data has not yet been written to the card (remaining capacity of the internal buffer memory). The slower the card, the faster the indicator will climb upward. If the indicator becomes full, movie shooting will stop automatically.

If the card has a fast writing speed, the indicator will either not appear or the level (if displayed) will hardly go upward.

First, shoot a few test movies to see if the card can write fast enough.



Playback and TV Connection

- If you connect the camera to a TV set (p.373) and shoot a movie, the TV set will not output any sound during the shooting. However, the sound will be properly recorded.

Restrictions on MP4-format Movies

Note that generally the following restrictions apply to MP4-format movies.

- Sound will not be recorded on approx. the last two frames.
- When you play back movies on Windows, images and sound may become slightly out of synchronization.

9

Image Playback

This chapter explains how to play back and erase photos and movies, how to display them on a TV screen, and other playback-related functions.

Images shot and saved with another device

The camera may not be able to properly display images captured with a different camera, edited with a computer, or that have had their file names changed.

▶ Image Playback

Single-Image Display



1 Play back the image.

- Press the <▶> button.
- ▶ The last image captured or played back will appear.



2 Select an image.

- To play back images starting with the last image captured, turn the <◀> dial counterclockwise. To play back images starting with the first captured image, turn the dial clockwise.
- Each time you press the <INFO.> button, the information display will change.



No information



Basic information display



Shooting information display

3 Exit the image playback.

- Press the <▶> button to exit the image playback and return to shooting-ready state.

Shooting Information Display

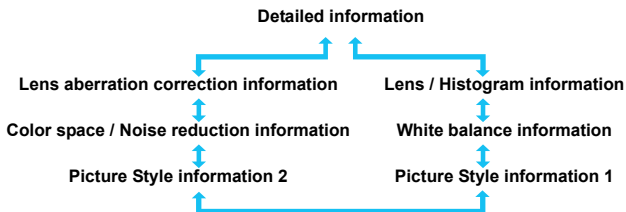

With the shooting information screen displayed (p.346), you can press the <▲> <▼> keys to change the shooting information displayed at the screen's bottom as follows. For details, see pages 349-350.

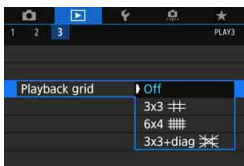

MENU Grid Display



In single-image display, you can overlay the grid on the image playback.

With [**▶3: Playback grid**], you can select [**3x3** , [**6x4** , or [**3x3+diag** ].

This function is convenient for checking the image's vertical or horizontal tilt as well as composition.

 The grid is not displayed during movie playback.

INFO.: Shooting Information Display

The information displayed varies depending on the shooting mode and settings.

Sample Information for Still Photos

● Basic information display

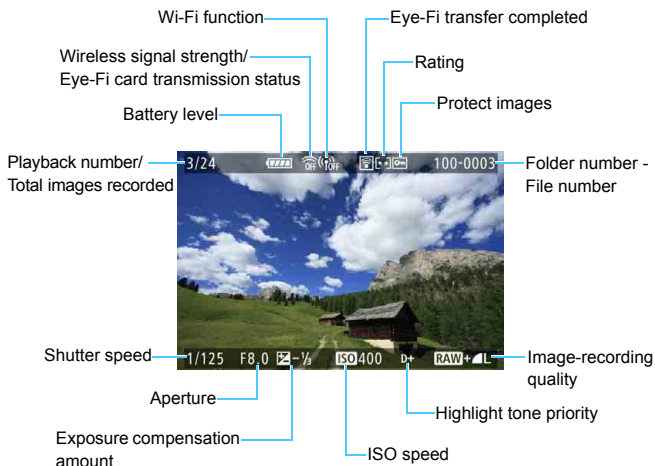

- If the image was taken by another camera, certain shooting information may not be displayed.
- It may not be possible to play back images taken with this camera on other cameras.

● Shooting information display

● Detailed information

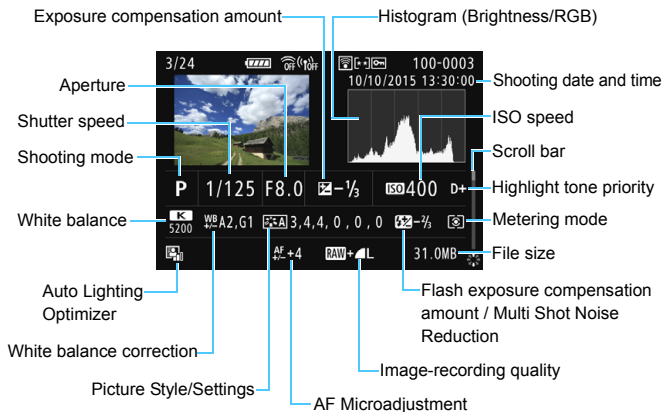

- * When you shoot in RAW+JPEG image quality, the RAW image file size will be displayed.
- * For images shot with flash and without exposure compensation, $<f>$ will be displayed.
- * $<HDR>$ and the dynamic range adjustment amount will be displayed for images shot with HDR shooting.
- * $<M>$ will be displayed for images shot with multiple-exposure shooting.
- * $<NR>$ will be displayed for images shot with Multi Shot Noise Reduction.
- * $<T>$ will be displayed for still photos taken as test shots for time-lapse movies.
- * $<C>$ will be displayed for images shot with the Creative filter function and for images that are processed (RAW image processing performed, resized, or Creative filter applied) and then saved.
- * For cropped images, $<C>$ and $<T>$ will be displayed.

• **Lens/Histogram information**

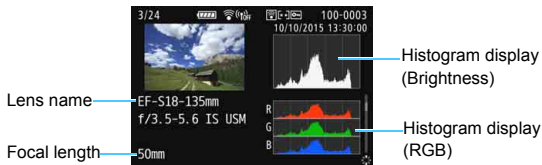

• **White balance information**

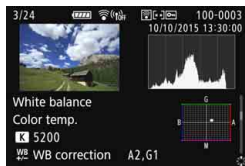

• **Picture Style information 1**



• **Picture Style information 2**

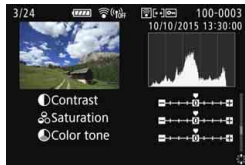

• **Color space / Noise reduction information**

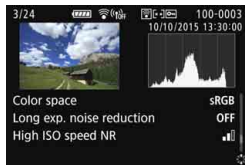

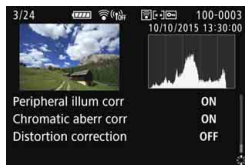

• **Lens aberration correction information**

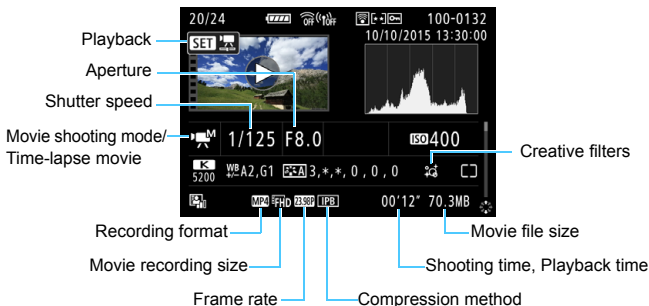

If you used GPS Receiver GP-E2 to record GPS information for the image, the “GPS information” screen will also appear.

Sample Movie Information Display



- * If manual exposure is used, the shutter speed, aperture, and ISO speed (when set manually) will be displayed.
- * The  icon will be displayed for video snapshots.
- * The  icon will be displayed for HDR movies.

 During movie playback, “*” will be displayed for **[Fineness]** and **[Threshold]** of **[Picture Style]**'s **[Sharpness]**.

● Highlight Alert

When [3: Highlight alert] is set to **[Enable]**, overexposed, clipped highlights will blink. To obtain more image detail in the overexposed, blinking areas, set the exposure compensation to a negative amount and shoot again.

- **AF Point Display**

When [**▶3: AF point disp.**] is set to [**Enable**], the AF point that has achieved focus will be displayed in red. If automatic AF point selection is set, multiple AF points may be displayed at the same time.

- **Histogram**

The brightness histogram shows the exposure level distribution and overall brightness. The RGB histogram is for checking the color saturation and gradation. The display can be switched with [**▶3: Histogram disp.**].

[Brightness] Display

This histogram is a graph showing the distribution of the image's brightness level. The horizontal axis indicates the brightness level (darker on the left and brighter on the right), while the vertical axis indicates how many pixels exist for each brightness level. The more pixels there are toward the left, the darker the image. The more pixels there are toward the right, the brighter the image. If there are too many pixels on the left, the shadow detail will be lost. If there are too many pixels on the right, the highlight detail will be lost. The gradation in-between will be reproduced. By checking the image and its brightness histogram, you can see the exposure level inclination and the overall gradation.

Sample Histograms



Dark image



Normal brightness



Bright image

[RGB] Display

This histogram is a graph showing the distribution of each primary color's brightness level in the image (RGB or red, green, and blue). The horizontal axis indicates the color's brightness level (darker on the left and brighter on the right), while the vertical axis indicates how many pixels exist for each color brightness level. The more pixels there are toward the left, the darker and less prominent the color. The more pixels there are toward the right, the brighter and denser the color. If there are too many pixels on the left, the respective color information will be lacking. If there are too many pixels on the right, the color will be too saturated with no gradation. By checking the image's RGB histogram, you can see the color's saturation and gradation condition, as well as white balance inclination.

▶ Searching for Images Quickly

❑ Displaying Multiple Images on One Screen (Index Display)

Search for images quickly with the index display showing 4, 9, 36, or 100 images on one screen.



1 Switch to the index display.

- During image playback, press the **<❑-Q>** button.
- ▶ The 4-image index display will appear. The selected image is highlighted with an orange frame.
- Pressing the **<❑-Q>** button will switch the display as follows: 9 images → 36 images → 100 images. Pressing the **<Q>** button will switch the display as follows: 100 images → 36 images → 9 images → 4 images → 1 image.



2 Select an image.

- Turn the **<☉>** dial to move the orange frame and select the image. You can also press the **<▲>** **<▼>** or **<◀>** **<▶>** keys to select the image.
- Turning the **<⚙️>** dial will display image(s) on the next or previous screen.
- Press **<SET>** in the index display to display the selected image in the single-image display.

📷 Jumping through Images (Jump Display)

In the single-image display, you can turn the <⚙️> dial to jump through the images forward or backward according to the jump method set.

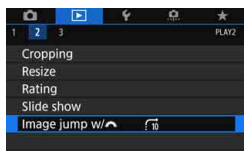

1 Select [Image jump w/⚙️].

- Under the [▶️2] tab, select [Image jump w/⚙️], then press <ⓈET>.

2 Select the jump method.

- Select the jump method, then press <ⓈET>.

📷: Display images one by one

📷10: Jump 10 images

📷100: Jump 100 images

📅: Display by date

📁: Display by folder

🎬: Display movies only

📷: Display stills only

📊: Display by image rating (p.359)

Turn the <⚙️> dial to select.

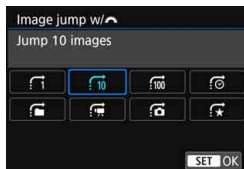

3 Browse by jumping.

- Press the <▶️> button to play back images.
- In the single-image display, turn the <⚙️> dial.
- ▶️ You can browse images with the method that was set.



Jump method

Playback position



- To search images by shooting date, select [Date].
- To search images by folder, select [Folder].
- If the card contains both movies and still photos, select [Movies] or [Stills] to display only one or the other.
- If no images match the selected [Rating], you cannot browse through the images with the <⚙️> dial.

/ **Magnified View**

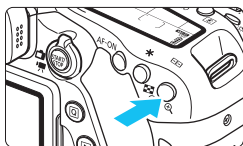
You can magnify a captured image by approx. 1.5x to 10x on the LCD monitor.



1 **Magnify the image.**



- Press the  button during image playback.
- ▶ The image will be magnified.
- If you hold down the  button, the image will be magnified until it reaches the maximum magnification.
- Press the  button to reduce the magnification. If you hold down the button, the magnification will be reduced to the single-image display.

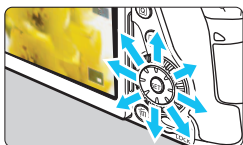

Magnified area position



2 **Scroll around the image.**

- Use  to scroll around the magnified image.
- To exit magnified view, press the  button and the single-image display will reappear.



- Turn the  dial to view another image while the magnification is maintained.
- Magnified view is not possible during the image review immediately after the image is taken.
- A movie cannot be magnified.

Playing Back with the Touch Screen

The LCD monitor is a touch-sensitive panel that you can touch with your fingers for various playback operations. **First, press the <▶> button to play back images.**

Browsing Images



Swipe with one finger.

- With single-image display, touch the LCD monitor with **one finger**. You can browse to the next or previous image by swiping your finger to the left or right.

Swipe to the left to see the next (newer) image, or swipe to the right to see the previous (older) image.

- With index display, also touch the LCD monitor with **one finger**. You can browse to the next or previous screen by swiping your finger up or down.

Swipe up to see the next (newer) images or swipe down to see the previous (older) images.

When you select an image, the orange frame will appear. Tap on the image again to display it as a single image.

Jumping through Images (Jump Display)



Swipe with two fingers.

Touch the LCD monitor with two fingers. When you swipe **two fingers** to the left or right, you can jump through images with the method set in **[Image jump w/ **] under the **[▶2]** tab.

Reducing Image (Index Display)



Pinch two fingers.

Touch the screen with two fingers spread apart, and pinch your fingers together on the screen.

- Each time you pinch your fingers, the single-image display will change to the index display. If you spread your fingers, the image display will change in the reverse order.
- When you select an image, the orange frame will appear. Tap on the image again to display it as a single image.

Magnifying Image



Spread two fingers apart.

Touch the screen with two fingers together, then spread your fingers apart on the screen.

- As you spread your fingers, the image will be magnified.
- The image can be magnified up to approx. 10x.
- You can scroll around the image by dragging your fingers.
- To reduce the image, pinch your fingers together on the screen.
- Tapping on the [↶] icon will return to the single-image display.





Touch screen operations on the camera's LCD monitor are also possible while playing back images on a TV set connected to your camera (p.373).

Rotating the Image

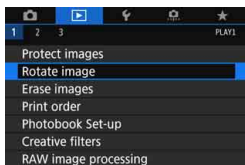
You can rotate the displayed image to the desired orientation.



1 Select [Rotate image].

- Under the [ 1] tab, select [Rotate image], then press < >.

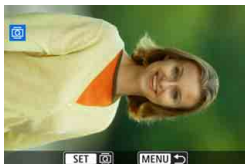







2 Select an image.

- Turn the < > dial to select the image to be rotated.
- You can also select an image in the index display (p.353).



3 Rotate the image.

- Each time you press < >, the image will rotate clockwise as follows: 90° → 270° → 0°.
- To rotate another image, repeat steps 2 and 3.

- If you set [ 1: Auto rotate] to [On  ] (p.387) before taking vertical shots, you need not rotate the image as described above.
- If the rotated image is not displayed in the rotated orientation during image playback, set [ 1: Auto rotate] to [On  ].
- A movie cannot be rotated.

MENU Setting Ratings

You can rate images (still photos and movies) with one of five rating marks: [★]/[★•]/[★••]/[★•••]/[★••••]. This function is called rating.

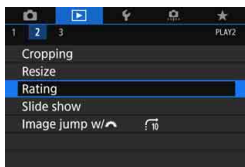

1 Select [Rating].

- Under the [▶] 2 tab, select [Rating], then press <SET>.



2 Select an image.

- Turn the <☉> dial to select an image or movie to be rated, then press <SET>.
- By pressing the <☒-Q> button, you can select images from a three-image display. To return to the single-image display, press the <Q> button.





3 Set the rating.

- Press the <▲> <▼> keys to select a rating.
- When you select a rating for the image, the number beside the set rating will increase by one.
- To rate another image, repeat steps 2 and 3.

 A total of up to 999 images of a given rating can be displayed. If there are more than 999 images with a given rating, [###] will be displayed.

Taking Advantage of Ratings

- With [] **2: Image jump w/ **, you can display only images having the specified rating.
- With [] **2: Slide show**, you can play back only images having the specified rating.
- Depending on the computer OS, you can see each file's rating as part of the file information display or in the provided image viewer (JPEG images only).

Q Quick Control for Playback

During playback, you can press the <Q> button to set the following: [**Protect images**], [Rotate image], [**Rating**], [RAW image processing], [Creative filters], [Resize (JPEG images only)], [Cropping (JPEG images only)], [**Highlight alert**], [**AF point display**], [Image jump w/ >], and [Send images to smartphone*].

For movies, only the functions in bold above can be set.

* Not selectable if [Wi-Fi/NFC] under [**1: Wireless communication settings**] is set to [Disable].

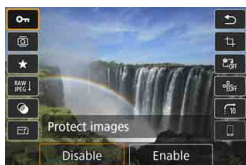

1 Press the <Q> button.

- During image playback, press the <Q> button.
- ▶ The Quick Control options will appear.









2 Select a function and set it.

- Press the <▲> <▼> keys to select a function.
- ▶ The current setting of the selected function is displayed at the bottom of the screen.
- Press the <◀> <▶> keys to change the setting.
- When setting the RAW image processing (p.390), Creative filters (p.399), Resize (p.395), Cropping (p.397), or Send images to smartphone, also press <SET> to finalize the setting.
- Image jump w/ : Set the Rating (p.354) by pressing the <INFO.> button.
- To cancel, press the <MENU> button.

3 Exit the setting.

- Press the < > button to exit the Quick Control screen.

 To rotate an image, set [**1: Auto rotate**] to [**On**  ]. If [**1: Auto rotate**] is set to [**On** ] or [**Off**], the [**@ Rotate image**] setting will be recorded to the image, but the camera will not rotate the image for display.

- 
- Pressing the < > button during the index display will switch to the single-image display and the Quick Control screen will appear. Pressing the < > button again will return to the index display.
 - For images taken with another camera, the options you can select may be restricted.

Enjoying Movies

You can play back movies in the following three ways:

Playback on a TV Set (p.373)



By connecting the camera to a TV set with HDMI Cable HTC-100, you can play back the camera's movies and still photos on the TV set.



- Since hard disk recorders do not have an HDMI IN terminal, the camera cannot be connected to a hard disk recorder with an HDMI cable.
- Even if the camera is connected to a hard disk recorder with a USB cable, movies and still photos cannot be played back or saved.

Playback on the Camera's LCD Monitor (p.365-372)

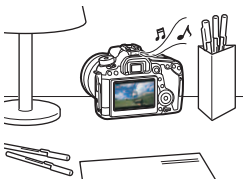

You can play back movies on the camera's LCD monitor. You can also edit out the movie's first and last scenes, and play back the still photos and movies on the card in an automatic slide show.



- A movie edited with a computer cannot be rewritten to the card and played back with the camera.

Playback and Editing with a Computer



The movie files recorded on the card can be transferred to a computer and played back or edited with pre-installed or general-purpose software compatible with the movie's recording format.

 To play back or edit a movie with commercially-available software, use software compatible with MOV-format and MP4-format movies. For details on commercially-available software, contact the software manufacturer.

▶▶▶ Playing Back Movies



1 Play back the image.

- Press the <▶> button to display an image.



2 Select a movie.

- Turn the <☉> dial to select the movie to be played back.
- In the single-image display, the <SET ▶> icon displayed on the upper left of the screen indicates a movie. If the movie is a video snapshot, <SET 📷> will be displayed.
- In the index display, perforations at the left edge of a thumbnail indicate a movie. **As movies cannot be played back from the index display, press <SET> to switch to the single-image display.**



3 In the single-image display, press <SET>.

- ▶ The movie playback panel will appear at the bottom of the screen.



4 Play back the movie.

- Select [▶] (Play), then press <SET>.
- ▶ The movie will start playing back.
- Press <SET> during playback to pause. Press again to resume.
- You can adjust the sound volume by turning the <☉> dial even during movie playback.
- For more details on the playback procedure, see the next page.

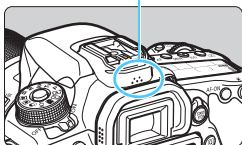

- Before listening to a movie's sound through headphones, turn down the volume to prevent hurting your ears.
- The camera may not be able to play back movies shot with another camera.

Movie Playback Panel

Operation	Playback Description
▶ Play	Pressing <ⓈET> toggles between play and stop.
▶ Slow motion	Adjust the slow motion speed by pressing the <◀> <▶> keys. The slow motion speed is indicated on the upper right of the screen.
◀◀ First frame	Displays the movie's first frame.
◀◀ Previous frame	Each time you press <ⓈET>, the previous frame is displayed. If you hold down <ⓈET>, it will rewind the movie.
▶▶ Next frame	Each time you press <ⓈET>, the movie will play frame-by-frame. If you hold down <ⓈET>, it will fast forward the movie.
▶▶ Last frame	Displays the movie's last frame.
🎵 Background music*	Plays back a movie with the selected background music (p.372).
✂ Edit	Displays the editing screen (p.367).
	Playback position
mm' ss"	Playback time (minutes:seconds)
🔊 Volume	Turn the <🔊> dial to adjust the volume of the built-in speaker (p.365).
MENU ↩	Press the <MENU> button to return to the single-image display.

* When background music is set, the movie sound will not be played back.

- 🔋 With a fully-charged Battery Pack LP-E6N, the continuous playback time at room temperature (23°C / 73°F) is approx. 3 hr. 40 min.
- 🎧 By connecting commercially-available headphones equipped with a 3.5 mm diameter stereo mini plug to the camera's headphone terminal (p.26), you can listen to the movie's sound (p.313).
- 📺 If you connect the camera to a TV set to play back a movie (p.373), adjust the sound volume with the TV set. (Turning the <🔊> dial will not change the sound volume.) If there is audio feedback, place the camera farther away from the TV set or turn down the TV sound volume.

Playback with the Touch Screen

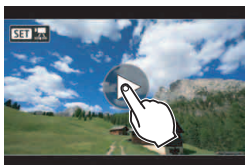

Tap [▶] on the center of the screen.

- ▶ The movie will start playing back.
- To display the movie playback panel, tap <SET [▶]> on the upper left of the screen.
- To pause the movie while it is playing back, tap on the screen. The movie playback panel will also appear.

✂ Editing a Movie's First and Last Scenes

You can edit out the first and last scenes of a movie in approx. 1-sec. increments.



1 On the movie playback screen, select [✂].

- ▶ The movie editing panel will be displayed at the bottom of the screen.



2 Specify the part to be edited out.

- Select either [X] (Cut beginning) or [Y] (Cut end), then press <SET>.
- Press the <◀> <▶> keys to see the previous or next frames. Holding down the key will fast forward or fast rewind the frames. Turn the <◉> dial for frame-by-frame playback.
- After deciding which part to edit out, press <SET>. The portion highlighted in white on the top is what will remain.





3 Check the edited movie.

- Select [▶] and press <SET> to play back the edited movie.
- To change the editing, go back to step 2.
- To cancel the editing, press the <MENU> button, then select [OK] on the confirmation dialog.



4 Save the edited movie.

- Select [⏏], then press <SET>.
- ▶ The save screen will appear.
- To save it as a new movie, select [New file]. To save it and overwrite the original movie file, select [Overwrite], then press <SET>.
- On the confirmation dialog, select [OK], then press <SET> to save the edited movie and return to the movie playback screen.

- Since the editing is performed in approx. 1-sec. increments (position indicated by [✂] on the top of the screen), the actual position where the movie is edited may differ from the position you specified.
- If the card does not have enough free space, [New file] will not be available.
- When the battery level is low, movie editing is not possible. Use a fully-charged battery.
- Movies shot with another camera cannot be edited with this camera.

MENU Slide Show (Auto Playback)

You can play back the images on the card as an automatic slide show.

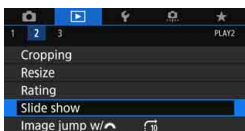

Number of images
to be played back

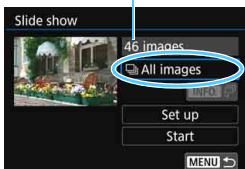

1 Select [Slide show].

- Under the [▶] 2 tab, select [Slide show], then press <SET>.

2 Select the images to be played back.

- Press the <▲> <▼> keys to select the desired option, then press <SET>.

All images/Movies/Stills

- Press the <▲> <▼> keys to select one of the following: [📁 All images] [🎬 Movies] [📷 Stills]. Then press <SET>.

Date/Folder/Rating

- Press the <▲> <▼> keys to select one of the following: [📅 Date] [📁 Folder] [★ Rating].
- When <INFO. [i]> is highlighted, press the <INFO.> button.
- Press the <▲> <▼> keys to select an option, then press <SET>.

[Date]



[Folder]

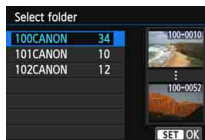

[Rating]

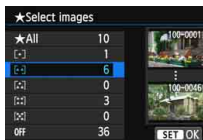

Item	Playback Description
All images	All the still photos and movies on the card will be played back.
Date	Still photos and movies taken on the selected shooting date will be played back.
Folder	Still photos and movies in the selected folder will be played back.
Movies	Only the movies on the card will be played back.
Stills	Only the still photos on the card will be played back.
Rating	Only the still photos and movies with the selected rating will be played back.

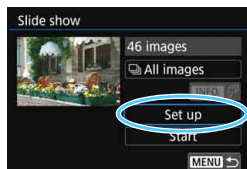

3 Configure [Set up] as desired.

- Press the <▲> <▼> keys to select [Set up], then press <SET>.
- Set the [Display time], [Repeat] (repeated playback), [Transition effect] (effect when changing images), and [Background music] for the still photos.
- The background music selection procedure is explained on page 372.
- After selecting the settings, press the <MENU> button.

[Display time]

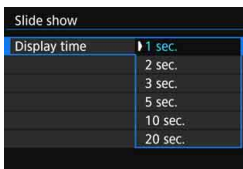

[Repeat]

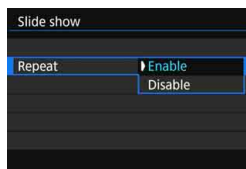

[Transition effect]

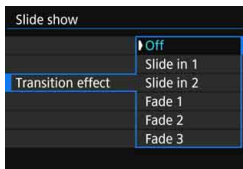

[Background music]

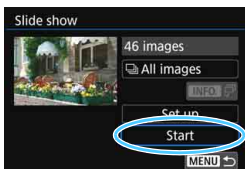
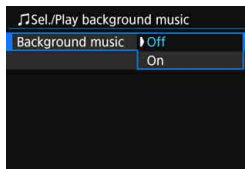

4 Start the slide show.

- Press the <▲><▼> keys to select [**Start**], then press <SET>.
- ▶ After [**Loading image...**] is displayed, the slide show will start.

5 Exit the slide show.

- To exit the slide show and return to the setting screen, press the <MENU> button.



- To pause the slide show, press <SET>. During pause, [||] will be displayed on the upper left of the image. Press <SET> again to resume the slide show.
- During auto playback of still photos, you can press the <INFO.> button to change the display format (p.346).
- During movie playback, you can adjust the sound volume by turning the <VOLUME> dial.
- During auto playback or pause, you can turn the <DISP.> dial to view another image.
- During auto playback, auto power off will not take effect.
- The display time may vary depending on the image.
- To view the slide show on a TV set, see page 373.

Selecting the Background Music

After you use EOS Utility (EOS software) to copy background music to the card, you can play background music together with the slide show.



1 Select [Background music].

- Set [Background music] to [On], then press <SET>.
- If the card has no background music, you cannot perform step 2.

2 Select the background music.

- Press the <▲> <▼> keys to select the desired background music, then press <SET>. You can also select multiple background music tracks.

3 Play the background music.

- To listen to a sample of the background music, press the <INFO.> button.
- Press the <▲> <▼> keys to play another background music track. To stop listening to the background music, press the <INFO.> button again.
- Adjust the sound volume by turning the <☀> dial.
- To delete a background music track, press the <▲> <▼> keys and select the track, then press the <🗑> button.

 At the time of purchase, the camera does not have background music. The procedure to copy background music to a card is explained in the EOS Utility Instruction Manual.

Viewing Images on a TV Set

By connecting the camera to a TV set with an HDMI cable, you can play the camera's still photos and movies on the TV set. For the HDMI cable, HDMI Cable HTC-100 (sold separately) is recommended.

If the picture does not appear on the TV screen, check if the [**3: Video system**] is correctly set to [**For NTSC**] or [**For PAL**] (depending on the video system of your TV set).

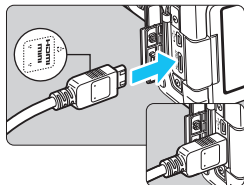

1 Connect the HDMI cable to the camera.

- With the plug's <▲ HDMI MINI> logo facing the front of the camera, insert it into the <HDMI OUT> terminal.

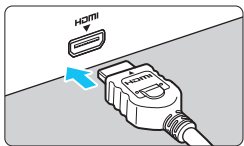

2 Connect the HDMI cable to the TV set.

- Connect the HDMI cable to the TV set's HDMI IN port.

3 Turn on the TV set and switch the TV set's video input to select the connected port.

4 Set the camera's power switch to <ON>.

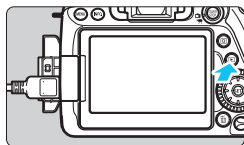

5 Press the <▶> button.

- ▶ The image will appear on the TV screen. (Nothing will be displayed on the camera's LCD monitor.)
- The images will automatically be displayed at the optimum resolution of the TV set.
- By pressing the <INFO.> button, you can change the display format.
- To play back movies, see page 365.

- Adjust movie sound volume with the TV set. The sound volume cannot be adjusted with the camera.
- Before connecting or disconnecting the cable between the camera and TV set, turn off the camera and TV set.
- Depending on the TV set, part of the image displayed may be cut off.
- Do not connect any other device's output to the camera's <HDMI OUT> terminal. Doing so may cause a malfunction.
- Certain TV sets may not be able to display the captured movies.

Using HDMI CEC TV Sets

If the TV set connected to the camera with an HDMI cable is compatible with HDMI CEC*, you can use the TV set's remote control for playback operations.

* An HDMI-standard function enabling HDMI devices to control each other so that you can control them with one remote control unit.

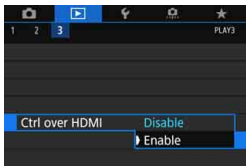

- 1 Select [Ctrl over HDMI].**
 - Under the [▶] 3 tab, select [Ctrl over HDMI], then press <SET>.
- 2 Select [Enable].**
- 3 Connect the camera to a TV set.**
 - Use an HDMI cable to connect the camera to the TV set.
 - ▶ The TV set's input will switch automatically to the HDMI port connected to the camera. If it does not switch automatically, use the TV set's remote control to select the HDMI IN port the cable is connected to.
- 4 Press the camera's <▶> button.**
 - ▶ An image will appear on the TV screen and you can use the TV set's remote control to play back images.

Still photo playback menu



Movie playback menu



 : Return

 : 9-image index

 : Play movie

 : Slide show

INFO. : Display shooting info

 : Rotate

5 Select an image.

- Point the remote control toward the TV set and press the ←/→ button to select an image.

6 Press the remote control's Enter button.

- ▶ The menu appears and you can perform the playback operations shown on the left.
- Press the ←/→ button to select the desired option, then press the Enter button. For a slide show, press the remote control's ↑/↓ button to select an option, then press the Enter button.
- If you select [**Return**] and press the Enter button, the menu will disappear and you can use the ←/→ button to select an image.



- Some TV sets require you to first enable the HDMI CEC connection. For details, refer to the TV set's instruction manual.
- Certain TV sets, even those compatible with HDMI CEC, may not operate properly. In such a case, set [**▶ 3: Ctrl over HDMI**] to [**Disable**], and use the camera to control the playback operation.



Protecting Images

You can set protections to prevent the precious images from being erased accidentally.

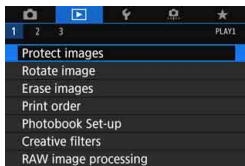
MENU Protecting a Single Image



1 Select [Protect images].

- Under the [ 1] tab, select [Protect images], then press < >.

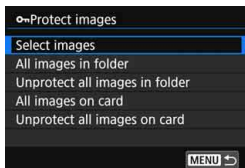





2 Select [Select images].

- ▶ An image will be displayed.

Image protect icon



3 Protect the image.

- Turn the < > dial to select the image to be protected, then press < >.
- ▶ The image will be protected, and the < > icon will appear at the top of the screen.
- To cancel the image protection, press < > again. The < > icon will disappear.
- To protect another image, repeat step 3.

MENU Protecting All Images in a Folder or on a Card

You can protect all the images in a folder or on a card at once.

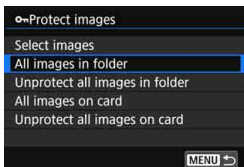

When you select **[All images in folder]** or **[All images on card]** in **[▶ 1: Protect images]**, all the images in the folder or on the card will be protected. To cancel the image protection, select **[Unprotect all images in folder]** or **[Unprotect all images on card]**.

! If you format the card (p.64), the protected images will also be erased.



- Movies can also be protected.
- Once an image is protected, it cannot be erased by the camera's erase function. To erase a protected image, you must first cancel the protection.
- If you erase all the images (p.379), only the protected images will remain. This is convenient when you want to erase unnecessary images all at once.

Erasing Images

You can either select and erase unnecessary images one by one or erase them in one batch. Protected images (p.376) will not be erased.

! Once an image is erased, it cannot be recovered. Make sure you no longer need the image before erasing it. To prevent important images from being erased accidentally, protect them. Erasing an image shot in RAW+JPEG will erase both the RAW and JPEG images.

Erasing a Single Image



1 Play back the image to be erased.

2 Press the  button.

▶ The Erase menu will appear.

3 Erase the image.

- Select **[Erase]**, then press **<SET>**. The image displayed will be erased.



MENU Checkmarking [✓] Images to Be Erased in a Batch

By adding checkmarks [✓] to the images to be erased, you can erase multiple images at once.

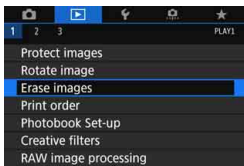

1 Select **[Erase images]**.

- Under the **[▶ 1]** tab, select **[Erase images]**, then press **<SET>**.

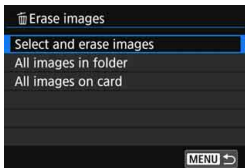

2 Select [Select and erase images].

- Select [Select and erase images], then press <SET>.
- ▶ An image will be displayed.



3 Select the images to be erased.

- Turn the <DIAL> dial to select the image to be erased, then press <SET>.
- ▶ A checkmark [✓] will be displayed on the upper left of the screen.
- By pressing the <MULTI-SELECT> button, you can select images from a three-image display. To return to the single-image display, press the <SINGLE-SELECT> button.
- To select another image to be erased, repeat step 3.

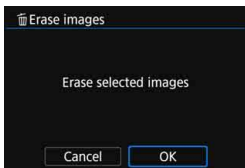

4 Erase the image.

- Press the <ERASE> button and select [OK].
- ▶ The selected images will be erased at once.

MENU Erasing All Images in a Folder or on a Card

You can erase all the images in a folder or on a card at once. When [▶ 1: Erase images] is set to [All images in folder] or [All images on card], all the images in the folder or on the card will be erased.

 To erase all images including protected images, format the card (p.64).

Digital Print Order Format (DPOF)

DPOF (Digital Print Order Format) enables you to print images recorded on the card according to your printing instructions such as the image selection, quantity to print, etc. You can print multiple images in one batch or give the print order to a photofinisher.

You can set the print type, date imprinting, and file number imprinting. The print settings will be applied to all print-ordered images. (They cannot be set individually for each image.)

Setting the Printing Options

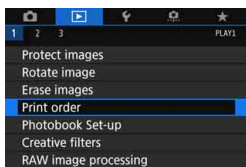

1 Select [Print order].

- Under the [▶1] tab, select [Print order], then press <SET>.

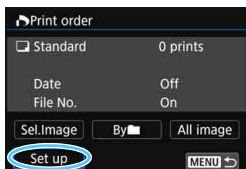

2 Select [Set up].

3 Set the option as desired.

- Set the [Print type], [Date], and [File No.].
- Select the option to be set, then press <SET>. Select the desired setting, then press <SET>.

[Print type]

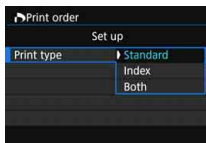

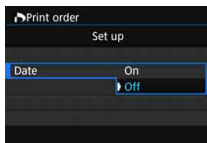

[Date]

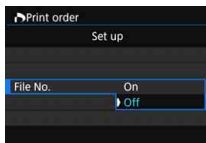

[File No.]



Print type		Standard	Prints one image on one sheet.
		Index	Multiple thumbnail images are printed on one sheet.
		Both	Prints both the standard and index prints.
Date	On	[On] imprints the recorded date on the print.	
	Off		
File number	On	[On] imprints the file number on the print.	
	Off		

4 Exit the setting.

- Press the <MENU> button.
- ▶ The print order screen will reappear.
- Next, select [Sel.Image], [By , or [All image] to order the images to be printed.

- RAW images and movies cannot be print ordered.
- Even if **[Date]** and **[File No.]** are set to **[On]**, the date or file number may not be imprinted depending on the print type setting and printer model.
- With **[Index]** prints, the **[Date]** and **[File No.]** cannot both be set to **[On]** at the same time.
- When printing with DPOF, use the card whose print order specifications have been set. It cannot be printed with the specified print order if you just extract images from the card and try to print them.
- Certain DPOF-compliant printers and photofinishers may not be able to print the images as you specified. Refer to the printer's instruction manual before printing, or check with your photofinisher about compatibility when ordering prints.
- Do not insert into the camera a card whose print order was set by a different camera and then try to specify a print order. All the print orders may be overwritten inadvertently. Also, the print order may not be possible, depending on the image type.

 You can send images to a wireless compatible printer supporting PictBridge (Wireless LAN) and print them. For details, refer to the Wireless Function Instruction Manual.

Print Ordering

Sel.Image

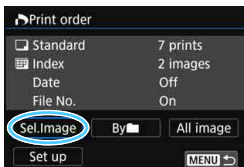

Select and order images one by one. By pressing the $\langle \text{Sel} \cdot \text{Image} \rangle$ button, you can select images from a three-image display. To return to the single-image display, press the $\langle \text{Image} \rangle$ button. Press the $\langle \text{MENU} \rangle$ button to save the print order to the card.



Quantity

Total images selected

[Standard] [Both]

Press the $\langle \blacktriangle \rangle$ $\langle \blacktriangledown \rangle$ keys to set the number of copies to be printed for the displayed image.

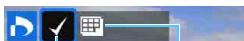

Checkmark

Index icon

[Index]

Press $\langle \text{SET} \rangle$ to add a checkmark to the box $[\checkmark]$. The image will be included in the index print.

By [Folder]

Select **[Mark all in folder]** and select the folder. A print order for one copy of all the images in the folder will be specified. If you select **[Clear all in folder]** and select the folder, the print order for that folder will all be canceled.

All image

If you select **[Mark all on card]**, one copy of all the images on the card will be set for printing. If you select **[Clear all on card]**, the print order will be cleared for all the images on the card.



- Note that RAW images and movies will not be included in the print order even if you set **[By [Folder]]** or **[All image]**.
- When using a printer supporting PictBridge, print no more than 400 images for one print order. If you specify more than this, all the images may not be printed.



Specifying Images for a Photobook

You can specify up to 998 images to be printed in a photobook. When you use EOS Utility (EOS software) to transfer images to a computer, the specified images will be copied to a dedicated folder. This function is useful for ordering photobooks online.

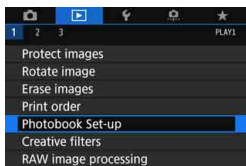
Specifying One Image at a Time



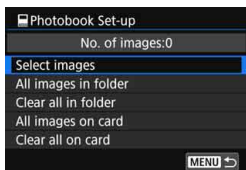

1 Select [Photobook Set-up].

- Under the [ 1] tab, select [Photobook Set-up], then press < >.





2 Select [Select images].

- An image will be displayed.
- To display the three-image display, press the < < > button. To return to the single-image display, press the < > button.



3 Select the image to be specified.

- Turn the < > dial to select the image to be specified, then press < >.
- Repeat this step to select another image. The number of images that have been specified will be displayed on the upper left of the screen.
- To cancel the image specification, press < > again.

Specifying All Images in a Folder or on a Card

You can specify all the images in a folder or on a card at once.

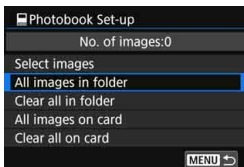

When [▶ 1: **Photobook Set-up**] is set to [**All images in folder**] or [**All images on card**], all the images in the folder or on the card will be specified.

To cancel the image specification, select [**Clear all in folder**] or [**Clear all on card**].



- RAW images and movies cannot be specified.
- Do not specify images already specified for a photobook in another camera for another photobook with this camera. The photobook settings may be overwritten.

Changing Image Playback Settings

MENU Adjusting the LCD Monitor Brightness

You can adjust the brightness of the LCD monitor to make it easier to view.

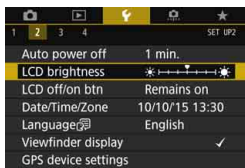

1 Select [LCD brightness].

- Under the [**2**] tab, select [**LCD brightness**], then press <SET>.



2 Adjust the brightness.

- While referring to the gray chart, press the <◀> <▶> keys, then press <SET>.

 To check the image's exposure, referring to the histogram is recommended (p.352).

MENU Auto Rotation of Vertical Images

Vertical images are rotated automatically so they are displayed vertically on the camera's LCD monitor and on the computer instead of horizontally. You can change the setting for this feature.

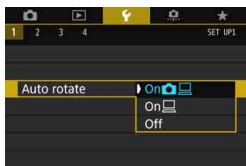
**1** Select **[Auto rotate]**.

- Under the [**1**] tab, select **[Auto rotate]**, then press **< (SET) >**.

2 Set the image rotation.

- Select the desired setting, then press **< (SET) >**.

- On**  

The vertical image is automatically rotated during playback on both the camera's LCD monitor and on the computer.

- On** 

The vertical image is automatically rotated only on the computer.

- Off**

The vertical image is not automatically rotated.



Auto rotation will not work with vertical images captured while auto rotation was **[Off]**. They will not rotate even if you later switch it to **[On]** for playback.



- Immediately after image capture, the vertical image will not be automatically rotated for the image review.
- If the vertical image is taken while the camera is pointed up or down, the image may not be rotated automatically for playback.
- If the vertical image is not automatically rotated on the computer screen, it means the software you are using is unable to rotate the image. Using the EOS software is recommended.

10

Post-Processing Images

You can process RAW images, resize or crop JPEG images, and apply a Creative filter.

- The ☆ icon at the upper right of the page title indicates that the function is available only in Creative Zone modes (**P/Tv/Av/M/B**).



- The camera may not be able to process images taken with another camera.
- Post-processing images as described in this chapter cannot be performed if the camera is set for multiple exposures or when it is connected to a computer via an interface cable.

RAW/JPEG ↓ Processing RAW Images with the Camera ☆

You can process **RAW** images with the camera and save them as JPEG images. As the RAW image itself does not change, you can apply different processing conditions to create any number of JPEG images from it.

Note that M RAW and S RAW images cannot be processed with the camera. Use Digital Photo Professional (EOS software, p.512) to process those images.

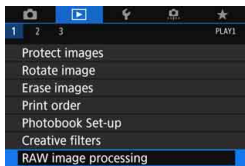

1 Select [RAW image processing].

- Under the [▶] 1 tab, select [**RAW image processing**], then press <SET>.
- RAW** images will be displayed.



2 Select an image.

- Turn the <◉> dial to select the image you want to process.
- By pressing the <☑> button, you can switch to the index display and select an image.



3 Process the image.

- Press <SET> to make the RAW processing options appear in a while (p.392).
- Press the <▲> <▼> <◀> <▶> keys to select an option, then turn the <◉> dial to change the setting.
- The displayed image will reflect such settings as “Brightness adjustment”, “White balance”, etc.
- To return to the image settings at the time of shooting, press the <INFO.> button.



Displaying the setting screen

- Press <SET> to display the setting screen. Turn the <☉> or <☼> dial to change the setting. Press <SET> to finalize the setting and return to the screen in step 3.



4 Save the image.

- Select [L] (Save), then press <SET>.
- Select [OK] to save the image.
- Check the destination folder and image file number, then select [OK].
- To process another image, repeat steps 2 to 4.

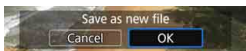

Magnified View







You can magnify the image by pressing the <Q> button in step 3. The magnification will differ depending on the pixel count of **[Image quality]** set in **[RAW image processing]**. With <☼>, you can scroll around the magnified image.



To cancel magnified view, press the <☒-Q> button.

Images with Aspect Ratio Setting

Frame lines indicating the shooting area will be displayed on images shot with the aspect ratio (p.146) set to **[4:3]**, **[16:9]**, or **[1:1]**. JPEG images generated from RAW images will be saved with the set aspect ratio.

RAW Image Processing Options

-  ± 0 Brightness adjustment
You can adjust the image brightness up to ± 1 stop in 1/3-stop increments. The displayed image will reflect the setting's effect.
-  White balance (p.162)
You can select the white balance. If you select [**AWB**] and press the <INFO.> button, you can select [**Auto: Ambience priority**] or [**Auto: White priority**]. If you select [**K**] and press the <INFO.> button, you can set the color temperature. The displayed image will reflect the setting's effect.
-  Picture Style (p.154)
You can select the Picture Style. By pressing the <INFO.> button, you can adjust the sharpness, contrast, and other parameters. The displayed image will reflect the setting's effect.
-  Auto Lighting Optimizer (p.169)
You can set the Auto Lighting Optimizer. The displayed image will reflect the setting's effect.
-  High ISO speed noise reduction (p.170)
You can set the noise reduction for high ISO speeds. The displayed image will reflect the setting's effect. If the effect is difficult to discern, magnify the image (p.391).
-  Image quality (p.142)
You can set the image quality when generating an image in JPEG format.

- **sRGB** Color space (p.181)
You can select either sRGB or Adobe RGB. Since the camera's LCD monitor is not compatible with Adobe RGB, the difference in the image will hardly be perceptible when either color space is set.
-  Peripheral illumination correction (p.175)
A phenomenon that makes the image corners look darker due to the lens characteristics can be corrected. If [**Enable**] is set, the corrected image will be displayed. If the effect is difficult to discern, magnify the image (p.391) and check the four corners. The peripheral illumination correction applied with the camera will be less pronounced than that applied with the Digital Photo Professional (EOS software) at maximum correction amount. If the effects of correction are not apparent, use Digital Photo Professional to apply the peripheral illumination correction.
-  Distortion correction
Image distortion due to lens characteristics can be corrected. If [**Enable**] is set, the corrected image will be displayed. The image periphery will be trimmed in the corrected image.
Since the image resolution may look slightly lower, adjust the sharpness with the Picture Style's [**Sharpness**] parameter setting as necessary.
-  Chromatic aberration correction (p.176)
Chromatic aberrations (color fringing along the subject's outline) due to the lens characteristics can be corrected. If [**Enable**] is set, the corrected image will be displayed. If the effect is difficult to discern, magnify the image (p.391).

Peripheral Illumination Correction, Distortion Correction, and Chromatic Aberration Correction

To perform peripheral illumination correction, distortion correction, and chromatic aberration correction, the correction data of the lens used is necessary. If you cannot apply correction when processing RAW images in the camera, use EOS Utility (EOS software, p.512) to register the correction data to the camera.

-  ● Processing RAW images in the camera will not produce exactly the same results as processing RAW images with Digital Photo Professional.
- When processing images with **[Distortion correction]** set to **[Enable]**, AF point display information (p.352) or Dust Delete Data (p.405) will not be appended to the image.

Resizing JPEG Images

You can resize a JPEG image to make the pixel count lower and save it as a new image. Resizing an image is possible with JPEG **L/M/S1/S2** images. **JPEG S3 and RAW images cannot be resized.**

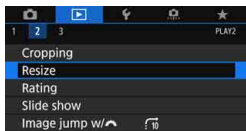

1 Select [Resize].

- Under the [**2**] tab, select [**Resize**], then press <SET>.
- ▶ An image will be displayed.



2 Select an image.

- Turn the <◉> dial to select the image you want to resize.
- By pressing the <☒-Q> button, you can switch to the index display and select an image.



Target sizes

3 Select the desired image size.

- Press <SET> to display the image sizes.
- Select the desired image size, then press <SET>.

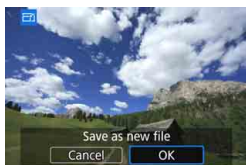

4 Save the image.

- Select [**OK**] to save the resized image.
- Check the destination folder and image file number, then select [**OK**].
- To resize another image, repeat steps 2 to 4.

Resize Options by Original Image Size

Original Image Size	Available Resize Settings			
	M	S1	S2	S3
L	<input type="radio"/>	<input type="radio"/>	<input type="radio"/>	<input type="radio"/>
M		<input type="radio"/>	<input type="radio"/>	<input type="radio"/>
S1			<input type="radio"/>	<input type="radio"/>
S2				<input type="radio"/>

Image Sizes

The image sizes by aspect ratios are shown in the table below.

Image Quality	Aspect Ratio and Pixel Count (Approx.)			
	3:2	4:3	16:9	1:1
M	3984x2656 (10.6 megapixels)	3552x2664 (9.5 megapixels)	3984x2240* (8.9 megapixels)	2656x2656 (7.1 megapixels)
S1	2976x1984 (5.9 megapixels)	2656x1992 (5.3 megapixels)	2976x1680* (5.0 megapixels)	1984x1984 (3.9 megapixels)
S2	1920x1280 (2.5 megapixels)	1696x1280* (2.2 megapixels)	1920x1080 (2.1 megapixels)	1280x1280 (1.6 megapixels)
S3	720x480 (0.35 megapixels)	640x480 (0.31 megapixels)	720x408* (0.29 megapixels)	480x480 (0.23 megapixels)

The items marked with an asterisk do not exactly match the indicated aspect ratio. The image will be cropped slightly.

🔗 Cropping JPEG Images

You can crop a JPEG image and save it as another image. **JPEG S3 and RAW images cannot be cropped.** JPEG images shot with RAW+JPEG can be cropped.

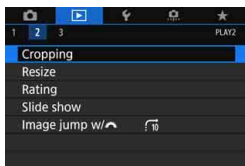

1 Select [Cropping].

- Under the [▶] 2 tab, select [Cropping], then press <SET>.
- ▶ An image will be displayed.



2 Select an image.

- Turn the <☉> dial to select the image you want to crop.
- By pressing the <☒-Q> button, you can switch to the index display and select an image.



3 Set the cropping frame size, aspect ratio, position, and orientation.

- Press <SET> to display the cropping frame.
- ▶ The image area within the cropping frame will be cropped.

Changing the Cropping Frame Size

- Press the <Q> or <☒-Q> button.
- ▶ The cropping frame size will change. The smaller the cropping frame, the larger the image magnification will be.

Changing the Aspect Ratio

- Turn the <☉> dial.
- ▶ Cropping frame aspect ratio will change to [3:2], [16:9], [4:3], or [1:1].

Moving the Cropping Frame

- Press the <▲> <▼> or <◀> <▶> keys.
- ▶ The cropping frame will move up, down, left, or right.
- You can also touch the frame and drag it to the desired position.

Switching the Orientations of the Cropping Frame

- Press the <INFO.> button.
- ▶ The cropping frame will switch between the vertical and horizontal orientations. This also enables you to crop a horizontally shot image to look as if it was shot in vertical orientation.



4 Check the image area to be cropped.

- Press the <[Q]> button.
- ▶ The image area to be cropped will be displayed.
- To return to the original display, press the <[Q]> button again.

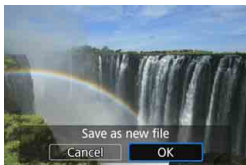

5 Save the image.

- Press <[SET]> and select [OK] to save the cropped image.
- Check the destination folder and image file number, then select [OK].
- To crop another image, repeat steps 2 to 5.

- ⚠ ● Once a cropped image is saved, it cannot be cropped again. In addition, you cannot resize it or apply a Creative filter.
- AF point display information (p.352) and Dust Delete Data (p.405) will not be appended to the cropped images.

- 📄 ● When [▶3: Playback grid] is set (p.347), you can keep the grid displayed while setting the cropping.

Applying Creative Filters

You can apply the following Creative filters to an image and save it as a new image: Grainy B/W, Soft focus, Fish-eye effect, Art bold effect, Water painting effect, Toy camera effect, and Miniature effect.

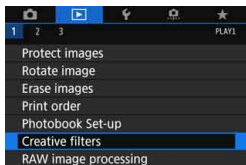

1 Select [Creative filters].

- Under the [▶1] tab, select [Creative filters], then press <SET>.
- ▶ An image will be displayed.



2 Select an image.

- Turn the <◉> dial to select the image you want to apply a filter to.
- By pressing the <🔍> button, you can switch to the index display and select an image.



3 Select a filter.

- When you press <SET>, the types of Creative filters will be displayed (p.400).
- Select a filter, then press <SET>.
- ▶ The image will be displayed with the effects of the filter applied.



4 Adjust the filter effect.

- Adjust the filter effect, then press <SET>.
- For the Miniature effect, press the <▲> <▼> keys to move the white frame to where you want the image to look sharp, then press <SET>.

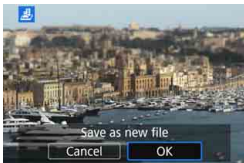

5 Save the image.

- Select [OK] to save the image.
- Check the destination folder and image file number, then select [OK].
- To apply a filter to another image, repeat steps 2 to 5.

- When shooting **RAW**+JPEG images, the Creative filter will be applied to the **RAW** image and the image will be saved as a JPEG image.
- When shooting **M RAW**+JPEG or **S RAW**+JPEG images, the Creative filter will be applied to the JPEG image.
- If an aspect ratio was set for a **RAW** image and the filter effect is applied to it, the image will be saved in the aspect ratio that is set.
- Dust Delete Data (p.405) will not be appended to images with Fish-eye effect applied.

Creative Filter Characteristics

- **Grainy B/W**
Creates a grainy black-and-white photo. You can change the black-and-white effect by adjusting the contrast.
- **Soft focus**
Gives the image a soft look. You can change the degree of softness by adjusting the blur.

-  **Fish-eye effect**

Gives the effect of a fish-eye lens. The image will have a barrel-type distortion.

Depending on the level of this filter effect, the area trimmed along the periphery of the image changes. Also, since this filter effect will magnify the image center, the apparent resolution at the center may degrade depending on the number of recorded pixels. Set the filter effect in step 4 while checking the resulting image.
-  **Art bold effect**

Makes the photo look like an oil painting and the subject look more three-dimensional. You can adjust the contrast and saturation. Note that subjects such as the sky or white walls may not be rendered with a smooth gradation and may look irregular or noise will become more noticeable.
-  **Water painting effect**

Makes the photo look like a watercolor painting with soft colors. You can control the color density by adjusting the filter effect. Note that some scenes including night scenes or low-light scenes may not be rendered with a smooth gradation and may look irregular or noise will become more noticeable.
-  **Toy camera effect**

Darkens the photo's corners and applies a unique color tone that makes it look as if it was shot by a toy camera. You can change the color cast by adjusting the color tone.
-  **Miniature effect**

Creates a diorama effect. You can change where the image looks sharp. In step 4, if you press the <INFO.> button (or tap on [INFO] at the screen's bottom), you can switch between the white frame's vertical and horizontal orientations.

11

Sensor Cleaning

The camera has a Self Cleaning Sensor Unit to automatically shake off dust adhered to the image sensor's front layer (low pass filter). The Dust Delete Data can also be appended to the image so that the dust spots remaining can be deleted automatically by Digital Photo Professional (EOS software, p.512).

Smudges adhering to the front of the sensor

Besides dust entering the camera from outside, in rare cases lubricant from the camera's internal parts may adhere to the front of the sensor. If visible spots still remain after the automatic sensor cleaning, having the sensor cleaned by a Canon Service Center is recommended.



Even while the Self Cleaning Sensor Unit is operating, you can press the shutter button halfway to interrupt the cleaning and start shooting immediately.

Automatic Sensor Cleaning

Whenever you set the power switch to <ON> or <OFF>, the Self Cleaning Sensor Unit is activated to automatically shake off the dust on the front of the sensor. Normally, you need not pay attention to this operation. However, you can choose to perform sensor cleaning manually, or disable it.

Cleaning the Sensor Now

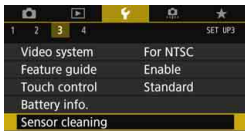

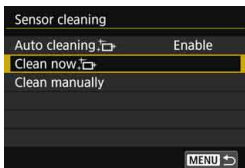

1 Select [Sensor cleaning].

- Under the [**3**] tab, select [**Sensor cleaning**], then press <SET>.



2 Select [Clean now].

- Select [**Clean now **], then press <SET>.
- Select [**OK**].
- ▶ The screen will indicate that the sensor is being cleaned. (A small sound may be heard.) Although there will be a shutter release sound during the cleaning, no picture is taken.

- For best results, perform the sensor cleaning with the camera placed upright and stable on a table or other flat surface.
- Even if you repeat the sensor cleaning, the result will not improve much. Immediately after the sensor cleaning is finished, the [**Clean now **] option remains disabled temporarily.

Disabling Automatic Sensor Cleaning

- In step 2, select [**Auto cleaning **] and set it to [**Disable**].
- ▶ The sensor cleaning will no longer be performed when you set the power switch to <ON> or <OFF>.

MENU Appending Dust Delete Data ☆

Normally, the Self Cleaning Sensor Unit will eliminate most of the dust that may be visible on captured images. However, in case visible dust still remains, you can append the Dust Delete Data to the image for erasing the dust spots later. The Dust Delete Data is used by Digital Photo Professional (EOS software, p.512) to erase the dust spots automatically.

Preparation

- Prepare a solid white object such as a sheet of paper.
- Set the lens focal length to 50 mm or longer.
- Set the lens's focus mode switch to <MF> and set the focus to infinity (∞). If the lens has no distance scale, rotate the camera to face toward you and turn the focusing ring clockwise all the way.

Obtaining the Dust Delete Data

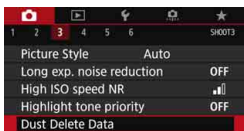

1 Select [Dust Delete Data].

- Under the [**3**] tab, select [**Dust Delete Data**], then press <SET>.

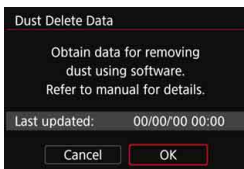

2 Select [OK].

- After the automatic self-cleaning of the sensor is performed, a message will appear. Although there will be a shutter release sound, during the cleaning, no picture is taken.

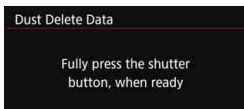
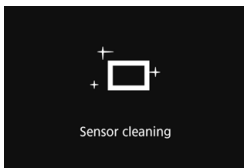

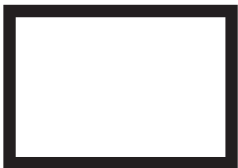

3 Shoot a solid-white object.

- At a distance of 20 cm - 30 cm (0.7 ft. - 1.0 ft.), fill the viewfinder with a patternless, solid-white object and take a picture.
- ▶ The picture will be taken in aperture-priority AE mode at an aperture of f/22.
- Since the image will not be saved, the data can still be obtained even if there is no card in the camera.
- ▶ When the picture is taken, the camera will start collecting the Dust Delete Data. When the Dust Delete Data is obtained, a message will appear.
- If the data is not obtained successfully, an error message will appear. Follow the “Preparation” procedure on the preceding page, then select [OK]. Take the picture again.

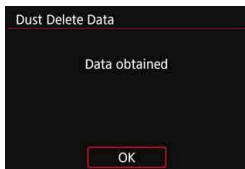

Dust Delete Data

After the Dust Delete Data is obtained, it is appended to all the JPEG and RAW images captured thereafter. Before an important shoot, it is recommended to update the Dust Delete Data by obtaining it again. For details about using Digital Photo Professional (EOS software, p.512) to erase dust spots, refer to the Digital Photo Professional Instruction Manual.

The Dust Delete Data appended to the image is so small that it hardly affects the image file size.

! Be sure to use a solid-white object such as a new sheet of white paper. If the object has any pattern or design, it may be recognized as dust data and affect the accuracy of the dust deletion with Digital Photo Professional (EOS software).

MENU Manual Sensor Cleaning [☆]

Dust that could not be removed by the automatic sensor cleaning can be removed manually with a commercially-available blower, etc. Before cleaning the sensor, detach the lens from the camera.

The image sensor is extremely delicate. If the sensor needs to be cleaned directly, having it done by a Canon Service Center is recommended.

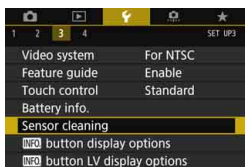

1 Select [Sensor cleaning].

- Under the [**3**] tab, select [**Sensor cleaning**], then press **<SET>**.

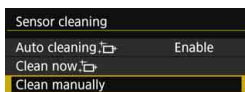

2 Select [Clean manually].



3 Select [OK].

- In a moment, the reflex mirror will lockup and the shutter will open.
- “CLn” will blink on the LCD panel.

4 Clean the sensor.

5 End the cleaning.

- Set the power switch to **<OFF>**.



- If you use a battery, make sure it is fully charged.
- If you use Battery Grip BG-E14 (sold separately) with AA/R6 batteries, manual sensor cleaning will not be possible.



For the power source, using DC Coupler DR-E6 (sold separately) and AC Adapter AC-E6N (sold separately) is recommended.

- When Multi Shot Noise Reduction is set, **[Clean manually]** cannot be selected.
- **While cleaning the sensor, never do any of the following. If the power is cut off, the shutter will close and the shutter curtains and image sensor may get damaged.**
 - **Setting the power switch to <OFF>.**
 - **Removing or inserting the battery.**
- The surface of the image sensor is extremely delicate. Clean the sensor with care.
- Use a plain blower without any brush attached. A brush may scratch the sensor.
- Do not insert the blower tip inside the camera beyond the lens mount. If the power is turned off, the shutter will close and the shutter curtains or reflex mirror may get damaged.
- Never use pressurized air or gas to clean the sensor. Pressurized air may damage the sensor, and sprayed gas may freeze on the sensor and scratch it.
- If the battery level becomes low while cleaning the sensor, the beeper will sound as a warning. Stop cleaning the sensor.
- If a smudge that cannot be removed with a blower remains, having the sensor cleaned by a Canon Service Center is recommended.

12

Customizing the Camera

You can make fine adjustments to various camera functions to suit your picture-taking preferences with Custom Functions.

Also, current camera settings can be saved under <C1> <C2> positions of the Mode Dial.

The functions explained in this chapter can be set and work only in the Creative Zone modes.

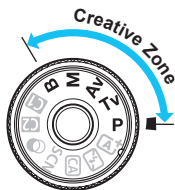

MENU Setting Custom Functions ☆

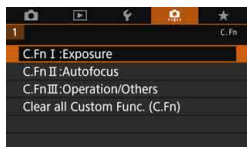

1 Select [**.Fn.**].

2 Select the group.

- Select C.Fn I, II, or III, then press <SET>.

Custom Function number

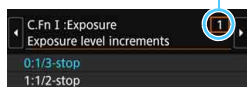

3 Select the Custom Function number.

- Press the <◀> <▶> keys to select the Custom Function number, then press <SET>.

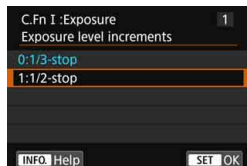

4 Change the setting as desired.

- Press the <▲> <▼> keys to select the desired setting (number), then press <SET>.
- Repeat steps 2 to 4 if you want to set other Custom Functions.
- At the bottom of the screen, the current Custom Function settings are indicated below the respective function numbers.

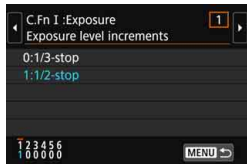

5 Exit the setting.

- Press the <MENU> button.
- ▶ The screen for step 2 will reappear.

Clearing All Custom Functions



In step 2, select [**Clear all Custom Func. (C.Fn)**] to clear all the Custom Function settings.

Even if you clear all the Custom Function settings, the [**.Fn III -4: Custom Controls**] settings will be retained.

MENU Custom Functions ☆



C.Fn I: Exposure

1	Exposure level increments	p.413
2	ISO speed setting increments	p.413
3	Bracketing auto cancel	p.413
4	Bracketing sequence	p.414
5	Number of bracketed shots	p.414
6	Safety shift	p.415

 LV Shooting	 Movie Shooting
○	○
○	In M
○	
○	
○	
○	

C.Fn II: Autofocus

1	Tracking sensitivity	p.416
2	Acceleration/deceleration tracking	p.417
3	AF point auto switching	p.417
4	AI Servo 1st image priority	p.418
5	AI Servo 2nd image priority	p.418
6	AF-assist beam firing	p.419
7	Lens drive when AF impossible	p.419
8	Select AF area selection mode	p.420
9	AF area selection method	p.420
10	Orientation linked AF point	p.421
11	Initial AF point,  AI Servo AF	p.422
12	Auto AF point selection: Color Tracking	p.422
13	AF point selection pattern	p.423
14	AF point display during focus	p.423
15	Viewfinder display illumination	p.424
16	AF Microadjustment	p.424



 LV Shooting	 Movie Shooting
○*	

* When an EX-series Speedlite (sold separately) equipped with an LED light is used.



Shaded Custom Functions do not function during Live View (LV) shooting or movie shooting. (Settings are disabled.)

C.Fn III: Operation/Others

			 LV Shooting	 Movie Shooting
1	Warnings  in viewfinder	p.425		
2	Dial direction during Tv/Av	p.425	○	○
3	Retract lens on power off	p.426	○	○
4	Custom Controls	p.426	Depends on setting	

MENU Custom Function Settings ☆

C.Fn I: Exposure

C.Fn I -1 Exposure level increments

0: 1/3-stop

1: 1/2-stop

Sets 1/2-stop increments for the shutter speed, aperture, exposure compensation, AEB, flash exposure compensation, etc. This is effective when you prefer to control the exposure in less fine increments than 1/3-stop increments.



When [1: 1/2-stop] is set, the exposure level will be displayed in the viewfinder and on the LCD panel as shown below.

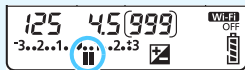

C.Fn I -2 ISO speed setting increments

0: 1/3-stop

You can set the ISO speed manually in 1/3-stop increments.

1: 1-stop

You can set the ISO speed manually in 1-stop increments.



Even if [1: 1-stop] is set, ISO speed will be automatically set in 1/3-stop increments when ISO Auto is set.

C.Fn I -3 Bracketing auto cancel

0: On

When you set the power switch to <OFF>, the AEB and white balance bracketing settings will be canceled. AEB will also be canceled when the flash is ready to fire or if you switch to movie shooting.

1: Off

The AEB and white balance bracketing settings will not be canceled even if you set the power switch to <OFF>. (If the flash is ready to fire or if you switch to movie shooting, AEB will be canceled temporarily, but the AEB range will be retained.)

C.Fn I -4 Bracketing sequence

The AEB shooting sequence and white balance bracketing sequence can be changed.

- 0: 0 → - → +
 1: - → 0 → +
 2: + → 0 → -

AEB	White Balance Bracketing	
	B/A Direction	M/G Direction
0 : Standard exposure	0 : Standard white balance	0 : Standard white balance
- : Decreased exposure	- : Blue bias	- : Magenta bias
+ : Increased exposure	+ : Amber bias	+ : Green bias

C.Fn I -5 Number of bracketed shots

The number of shots taken with AEB and white balance bracketing can be changed from the default 3 shots to 2, 5, or 7 shots.

When [**Bracketing sequence: 0**] is set, the bracketed shots will be taken as shown in the table below.

- 0: 3 shots
 1: 2 shots
 2: 5 shots
 3: 7 shots

(1-stop/step increments)

	1st Shot	2nd Shot	3rd Shot	4th Shot	5th Shot	6th Shot	7th Shot
0: 3 shots	Standard (0)	-1	+1				
1: 2 shots	Standard (0)	±1					
2: 5 shots	Standard (0)	-2	-1	+1	+2		
3: 7 shots	Standard (0)	-3	-2	-1	+1	+2	+3

 If [**1:2 shots**] is set, you can select the + or - side when setting the AEB range. With WB bracketing, the 2nd shot will be adjusted toward the minus direction for either B/A or M/G (toward Blue and Magenta).

C.Fn I -6 Safety shift

0: Disable

1: Shutter speed/Aperture

Takes effect in the <Tv> shutter-priority AE and <Av> aperture-priority AE modes. If the subject brightness changes and the standard exposure cannot be obtained within the autoexposure range, the camera will automatically change the manually-selected setting to obtain the standard exposure.

2: ISO speed

Works in the <P> Program AE, <Tv> shutter-priority AE, and <Av> aperture-priority AE modes. If the subject brightness changes and the standard exposure cannot be obtained within the autoexposure range, the camera will automatically change the manually set ISO speed to obtain the standard exposure.



- Under [**2: ISO speed settings**], even if [**Range for stills**] or [**Min. shutter spd.**] is changed from the default setting, safety shift will override it if the standard exposure cannot be obtained.
- The minimum and maximum ISO speeds of the safety shift using the ISO speed will be determined by the [**Auto range**] setting (p.152). However, if the manually set ISO speed exceeds the [**Auto range**], the safety shift will take effect up or down to the manually set ISO speed.
- Safety shift will take effect if necessary even when flash is used.

C.Fn II: Autofocus

C.Fn II -1 Tracking sensitivity

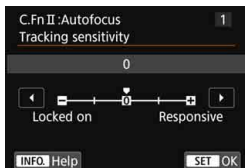

Sets the subject-tracking sensitivity during AI Servo AF when an obstacle cuts across the AF points or when the AF points stray from the subject.

0: Default setting suited for most subjects. Suitable for moving subjects in general.

Locked on: -2 / Locked on: -1

The camera will try to continue focusing on the subject even if an obstacle cuts across the AF points or if the subject strays from the AF points. The -2 setting makes the camera keep tracking the target subject longer than the -1 setting.

However, if the camera focuses on a wrong subject, it may take slightly longer to switch and focus on the target subject.

Responsive: +2 / Responsive: +1

The camera can focus consecutively on subjects at different distances that are covered by the AF points. Also effective when you want to always focus on the closest subject. The +2 setting is more responsive than the +1 setting when focusing on the next subject.

However, the camera will be more prone to focus on an unintended subject.

 **[Tracking sensitivity]** is the feature named **[AI Servo tracking sensitivity]** in the EOS-1D Mark III/IV, EOS-1Ds Mark III, and EOS 7D.

C.Fn II -2 Acceleration/deceleration tracking

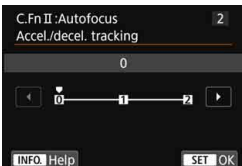

This sets the tracking sensitivity for moving subjects whose speed can momentarily change dramatically by starting or stopping suddenly, etc.

0: Suited for subjects that move at a steady speed (minor changes in moving speed).

+2 / +1:

Effective for subjects having sudden movements, sudden acceleration/deceleration, or sudden stops. Even if the moving subject's speed suddenly changes dramatically, the camera continues to focus on the target subject. For example, for an approaching subject, the camera becomes less prone to focus behind it to avoid subject blur. For a subject stopping suddenly, the camera becomes less prone to focus in front of it. Setting +2 can track dramatic changes in the moving subject's speed better than with +1.

However, since the camera will be sensitive to even slight movements of the subject, the focusing may be unstable momentarily.

C.Fn II -3 AF point auto switching

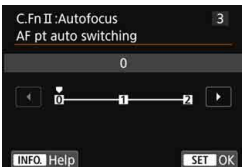

This sets the switching sensitivity of the AF points as they track the subject moving dramatically up, down, left, or right.

This setting takes effect when the AF area selection mode is set to Zone AF (manual selection of zone), Large Zone AF (manual selection of zone), or 45-point automatic selection AF.

0: Standard setting for gradual AF point switching.

+2 / +1:

Even if the target subject moves dramatically up, down, left, or right and moves away from the AF point, the camera switches its focus to neighboring AF points to continue focusing on the subject. The camera switches to the AF point deemed most likely to focus on the subject based on the subject's continual movement, contrast, etc. Setting +2 makes the camera more prone to switch the AF point than with +1.

However, with a wide-angle lens having a wide depth of field or if the subject is too small in the frame, the camera may focus with the wrong AF point.

C.Fn II -4 AI Servo 1st image priority

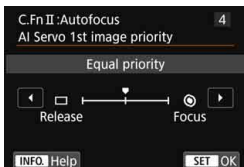

You can set the AF operation characteristics and shutter-release timing for the first shot with AI Servo AF.

Equal priority:

Equal priority is given to focusing and shutter release.

□: **Release priority**

Pressing the shutter button takes the picture immediately even if focus has not been achieved. Useful when you want to give priority to capturing the image rather than achieving focus.

⊙: **Focus priority**

Pressing the shutter button does not take the picture until focus is achieved. Useful when you want to achieve focus before capturing the shot.

C.Fn II -5 AI Servo 2nd image priority

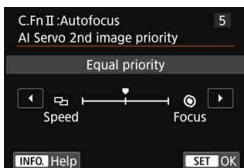

You can set the AF operation characteristics and shutter-release timing during continuous shooting after the first shot with AI Servo AF.

Equal priority:

Equal priority is given to focusing and continuous shooting speed. In low light or with low-contrast subjects, shooting speed may slow down.

□: **Shooting speed priority**

Priority is given to the continuous shooting speed instead of achieving focus.

⊙: **Focus priority**

Priority is given to achieving focus instead of the continuous shooting speed. The picture will not be taken until focus is achieved.

ⓘ Under shooting conditions which activate anti-flicker shooting (p.179), even if [Speed] is set, the continuous shooting speed may become slower or the shooting interval may become irregular.

C.Fn II -6 AF-assist beam firing

Enables or disables the built-in flash's AF-assist beam or the EOS-dedicated external Speedlite's AF-assist beam.

0: Enable

The AF-assist beam will be emitted when necessary.

1: Disable

The AF-assist beam will not be emitted. This prevents the AF-assist beam from disturbing others.

2: Enable external flash only

If an external Speedlite is attached, it will emit the AF-assist beam when necessary. The camera's built-in flash will not fire the AF-assist beam.

3: IR AF assist beam only

When an external Speedlite is attached, only the infrared AF-assist beam will be emitted. Set this when you do not want the camera to fire the AF-assist beam as a burst of small flashes.

With an EX-series Speedlite equipped with an LED light, the LED light will not automatically turn on for AF-assist.



If the external Speedlite's **[AF-assist beam firing]** Custom Function is set to **[Disable]**, this function's setting will be overridden and the AF-assist beam will not be emitted.

C.Fn II -7 Lens drive when AF impossible

If focus cannot be achieved with autofocus, you can have the camera keep searching for the correct focus or have it stop searching.

0: Continue focus search

1: Stop focus search

If autofocus starts and the focus is far off or if focus cannot be achieved, the lens drive stops. This prevents the lens from becoming grossly out of focus due to focus searching.



- Super telephoto lenses, etc., with a wide focusing drive range can become grossly out of focus during focus search, taking more time to achieve focus next time. Setting **[1: Stop focus search]** is recommended.
- Even if **[0: Continue focus search]** is set, focus search may not be performed when a wide-angle lens is used.

C.Fn II -8 Select AF area selection mode

You can limit the selectable AF area selection modes to suit your shooting preferences. Select the desired selection mode and press <[SET]> to add a checkmark [✓]. Then select [OK] to register the setting.

: **Manual selection:1 pt AF**

You can select one AF point.

: **Manual select.:Zone AF**

The AF area is divided into nine focusing zones for focusing.

: **Manual select.:Large Zone AF**

The AF area is divided into three focusing zones for focusing.

: **Auto selection:45 pt AF**

The Area AF frame (entire AF area) is used for focusing.

-  • The [✓] mark cannot be deleted from [Manual selection:1 pt AF].
- If the attached lens belongs to group H (p.131), you can only select [Manual selection:1 pt AF].

C.Fn II -9 AF area selection method



You can set the method for changing the AF area selection mode.

0:  → **AF area selection button**

After you press the <[AF area selection button]> or <[AF area selection button]> button, each time you press the <[AF area selection button]> button, the AF area selection mode changes.

1:  → **Main Dial**

After you press the <[Main Dial]> or <[Main Dial]> button, turning the <[Main Dial]> dial changes the AF area selection mode.

-  When [1:  → Main Dial] is set, use <[Main Dial]> to move the AF point horizontally.

C.Fn II -10 Orientation linked AF point

You can set the AF point or the AF area selection mode + AF point separately for vertical shooting and horizontal shooting.

0: Same for both vertical/horizontal

The same AF area selection mode and manually-selected AF point (or zone) are used for both vertical shooting and horizontal shooting.

1: Separate AF pts: Area+pt

The AF area selection mode and AF point (or zone) can be set separately for each camera orientation (1. Horizontal, 2. Vertical with the camera grip at the top, 3. Vertical with the camera grip at the bottom).

When you manually select the AF area selection mode and AF point (or zone) for each of the three camera orientations, they will be registered for the respective orientation. Whenever you change the camera orientation during shooting, the camera will switch to the AF area selection mode and manually-selected AF point (or zone) set for that orientation.

2: Separate AF pts: Pt only

The AF point can be set separately for each camera orientation (1. Horizontal, 2. Vertical with the camera grip at the top, 3. Vertical with the camera grip at the bottom). While using the same AF area selection mode, the AF point will switch automatically for the respective camera orientation.

When you manually select the AF point for each of the three camera orientations, it will be registered for the respective orientation. During shooting, the AF point will switch to the manually-selected one depending on the camera orientation. Even if you change the AF area selection mode to Manual selection:1 pt AF, the AF point set for the respective orientation will be retained. If you change the AF area selection mode to Zone AF (manual selection of zone) or Large Zone AF (manual selection of zone), the zone will switch to the manually-selected one depending on the camera orientation.



If you set this and later attach a lens from a different AF group (p.128-131, particularly Group H), the setting may be cleared.

C.Fn II -11 Initial AF Point, AI Servo AF

You can set the AI Servo AF's starting AF point for when the AF area selection mode is set to Auto selection: 45 pt AF.

0: Auto

The AF point which AI Servo AF starts with is set automatically to suit the shooting conditions.

1: Initial AF pt selected

AI Servo AF will start with the manually-selected AF point when the AF operation is set to AI Servo AF and the AF area selection mode is set to Auto selection: 45 pt AF.

2: Manual AF pt

If you switch from Manual selection: 1 pt AF to Auto selection: 45 pt AF, AI Servo AF will start with the AF point that was manually selected before the switch. Convenient if you want AI Servo AF to start with the AF point that was selected before the AF area selection mode was switched to Auto selection: 45 pt AF.



When [2: Manual  AF pt] is set, AI Servo AF will start with the zone that corresponds to the manually selected AF point, even if you switch AF area selection mode to Zone AF (manual selection of zone) or Large Zone AF (manual selection of zone).

C.Fn II -12 Auto AF point selection: Color Tracking

Use this function to autofocus by recognizing colors equivalent to skin tones. This function works when the AF area selection mode is set to Zone AF (manual selection of zone), Large Zone AF (manual selection of zone), or 45-point automatic selection AF.

0: Enable

The camera selects AF points automatically based on AF information and information on colors equivalent to skin tones. In One-Shot AF mode, focusing on a still human subject in the AF area is made easier.

In AI Servo AF mode, focusing on a human subject in the AF area is made easier. If no skin tones can be detected, the nearest subject will be focused on. Once focus is achieved, AF points are automatically selected so that the camera continues to focus on the color of the area it focused on first.

1: Disable

AF points are automatically selected based only on AF information.



- With setting [0: **Enable**], focusing will take slightly longer than with setting [1: **Disable**].
- Even with setting [0: **Enable**], the expected result may not be obtained depending on the shooting conditions and subject.
- Under light so low that the flash emits the AF-assist beam automatically, AF points are selected automatically based only on AF information. (The AF will not use information on colors equivalent to skin tones.)

C.Fn II -13 AF point selection pattern

During manual AF point selection, the selection can either stop at the outer edge or it can cycle around to the opposite side.

This works with any AF area selection mode other than 45-point automatic selection AF (with AI Servo AF enabled).

0: **Stops at AF area edges**

Useful if you often use an AF point along the edge.

1: **Continuous**

Instead of stopping at the outer edge, the selection of AF point continues to the opposite side.

C.Fn II -14 AF point display during focus

You can set whether or not to display the AF point(s) in the following cases: 1. when selecting the AF point(s), 2. when the camera is ready to shoot (before AF operation), 3. during AF operation, and 4. when focus is achieved.

0: **Selected (constant)**

The selected AF point(s) is always displayed.

1: **All (constant)**

All the AF points are always displayed.

2: **Selected (pre-AF, focused)**

The selected AF point(s) is displayed for 1, 2, and 4.

3: **Selected (focused)**

The selected AF point(s) is displayed for 1 and 4.

4: **Disable display**

For 2, 3, and 4, the selected AF point(s) will not be displayed.



If [2: **Selected (pre-AF, focused)**] or [3: **Selected (focused)**] is set, the AF point will not be displayed even when focus is achieved with AI Servo AF.

C.Fn II -15 Viewfinder display illumination

You can set whether or not the AF points in the viewfinder will light up in red when focus is achieved.

0: Auto

The AF points automatically light up in red under low light.

1: Enable

The AF points light up in red regardless of the ambient light level.

2: Disable

The AF points do not light up in red.

When you press the <Q> button with [0: Auto] or [1: Enable] set, you can set whether the AF point lights up in red (blink) during AI Servo AF.

AF point during AI Servo AF

AF point during AI Servo AF	
Non illuminated	OFF
Illuminated	ON

OFF: Non illuminated

The AF points will not light up during AI Servo AF.

ON: Illuminated

The AF points used for focusing light up in red during AI Servo AF. They are also illuminated during continuous shooting.

This function will not work if [VF display illumination] is set to [2: Disable].



- When you press the <Fn> or <Fn> button, the AF points will be illuminated in red regardless of this setting.
- The aspect ratio lines (p.146), and the electronic level, grid, and flicker detection set with [2:Viewfinder display] will also light up in red.

C.Fn II -16 AF Microadjustment

You can make fine adjustments for the AF's point of focus. For details, see page 427.

C.Fn III: Operation/Others

C.Fn III -1 Warnings in viewfinder

When any of the following functions are set, the  icon can be displayed on the viewfinder's bottom right (p.29). The  icon will also appear on the shooting function settings display (p.55).

Select the function for which you want the warning icon to appear, press  to add a checkmark [✓], then select [OK].

When monochrome is set:

If the Picture Style is set to [Monochrome] (p.155), the warning icon will appear.

When WB is corrected:

If white balance correction is set (p.167), the warning icon will appear.

When is set:

If [CAMERA 3: High ISO speed NR] is set to [Multi Shot Noise Reduction] (p.170), the warning icon will appear.

When HDR is set:





If [CAMERA 3: HDR Mode] is set (p.207), the warning icon will appear.

C.Fn III -2 Dial direction during Tv/Av

0: Normal

1: Reverse direction

Dial turning direction when setting the shutter speed and aperture can be reversed.

In the **<M>** shooting mode, the turning direction of the  and  dials will be reversed. In other shooting modes, the turning direction of only the  dial will be reversed. The  dial's turning direction in the **<M>** mode and the turning direction to set the exposure compensation in the **<P>**, **<Tv>**, and **<Av>** mode will be the same.

C.Fn III -3 Retract lens on power off

This is to set the lens retraction mechanism for when a gear-driven STM lens (such as EF40mm f/2.8 STM) is attached to the camera. You can set it to retract the extended lens automatically when the camera's power switch is set to <OFF>.

0: Enable

1: Disable

- With auto power off, the lens will not retract regardless of the setting.
- Before detaching the lens, make sure that it is retracted.

 With setting [**0: Enable**], this function takes effect regardless of the lens's focus mode switch setting (AF or MF).

C.Fn III -4 Custom Controls

You can assign often-used functions to camera buttons or dials according to your preferences. For details, see page 433.

: Fine Adjustment of AF's Point of Focus

Fine adjustment of the AF's point of focus is possible for viewfinder shooting. This is called "AF Microadjustment". Before making the adjustment, read "General Cautions for AF Microadjustment" on page 432.

 Normally, this adjustment is not required. Perform this adjustment only if necessary. Note that performing this adjustment may prevent accurate focusing from being achieved.

1: Adjust All by Same Amount

Set the adjustment amount manually by repeatedly making adjustments, shooting, and checking the results until the desired result is achieved. During AF, regardless of the lens used, the point of focus will always be shifted by the adjustment amount.

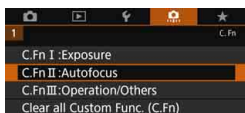

1 Select [C.Fn II: Autofocus].

- Under the [] tab, select [C.Fn II: Autofocus], then press <SET> >.

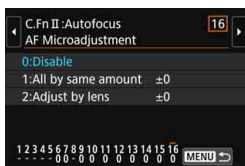

2 Select [16: AF Microadjustment].



3 Select [1: All by same amount].

4 Press the <Q> button.

- The [1: All by same amount] screen will appear.

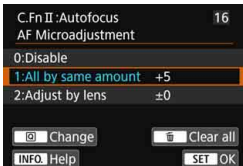
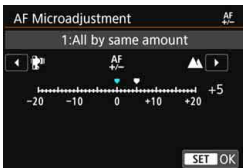

5 Make the adjustment.

- Set the adjustment amount. The adjustable range is ± 20 steps.
- Setting it toward “-: 📷” will shift the point of focus in front of the standard point of focus.
- Setting it toward “+: 📷” will shift the point of focus to the rear of the standard point of focus.
- After making the adjustment, press $\langle \text{SET} \rangle$.
- Select [**1: All by same amount**], then press $\langle \text{SET} \rangle$.
- Press the $\langle \text{MENU} \rangle$ button to exit.

6 Check the result of the adjustment.

- Take a picture and play back the image (p.346) to check the adjustment result.
- If the shooting result comes out with focus in front of the targeted point, adjust toward the “+: 📷” side. If it comes out with focus behind the targeted point, adjust toward the “-: 📷” side.
- If necessary, repeat the adjustment.

🔍 If [**1: All by same amount**] is selected, separate AF adjustment will not be possible for the wide-angle and telephoto ends of zoom lenses.

2: Adjust by Lens

You can make the adjustment for each lens and register the adjustment in the camera. You can register the adjustment for up to 40 lenses. When you autofocus with a lens whose adjustment is registered, the point of focus will always be shifted by the adjustment amount. Set the adjustment manually by repeatedly making adjustments, shooting, and checking the results until the desired result is achieved. If you use a zoom lens, make the adjustment for the wide-angle (W) and telephoto (T) ends.

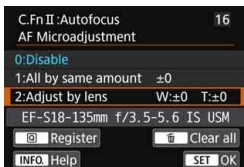

1 Select [2: Adjust by lens].

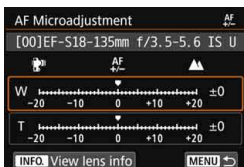

2 Press the <Q> button.

- ▶ The [2: Adjust by lens] screen will appear.

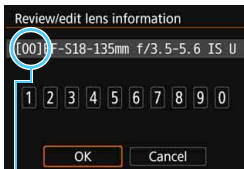

3 Check and change the lens information.
Checking the Lens Information

- Press the <INFO.> button.
- ▶ The screen will show the lens name and a 10-digit serial number. When the serial number is displayed, select [OK] and go to step 4.
- If the lens's serial number cannot be confirmed, "0000000000" will be displayed. In this case, enter the number by following the instructions on the next page.
- Regarding the asterisk "*" displayed in front of some lens serial numbers, see the next page.

Registered number

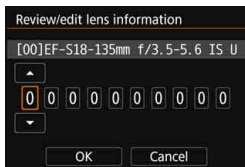

Entering the Serial Number

- Select the digit to be entered, then press <Ⓔ> so <☒> is displayed.
- Enter the number, then press <Ⓔ>.
- After entering all the digits, select [OK].

Lens Serial Number

- In step 3, if “*” appears in front of the 10-digit lens serial number, you can register only one unit of the same lens model. Even if you enter the serial number, “*” will remain displayed.
- The lens serial number on the lens may differ from the serial number displayed on the screen in step 3. This is not a malfunction.
- If the lens serial number includes letters, enter only the numbers.
- If the lens serial number is eleven digits or longer, enter only the last ten digits.
- The location of the serial number varies depending on the lens.
- Some lenses may not have a serial number inscribed. To register a lens that has no serial number inscribed, enter any serial number.



- If [2: Adjust by lens] is selected and an Extender is used, the adjustment will be registered for the lens and Extender combination.
- If 40 lenses have already been registered, a message will appear. After you select a lens whose registration is to be erased (overwritten), you can register another lens.

Single focal length lens

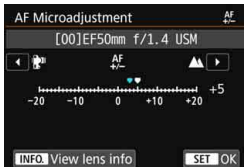

Zoom lens

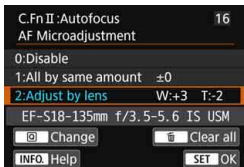
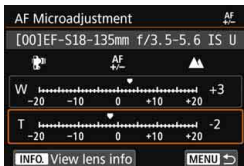

4 Make the adjustment.



- For a zoom lens, select the wide-angle (W) or telephoto (T) end. Pressing $\langle \text{SET} \rangle$ will turn off the frame and make the adjustment possible.
- Set the adjustment amount, then press $\langle \text{SET} \rangle$. The adjustable range is ± 20 steps.
- Setting it toward “-: ” will shift the point of focus in front of the standard point of focus.
- Setting it toward “+: ” will shift the point of focus to the rear of the standard point of focus.
- For a zoom lens, repeat this procedure and adjust it for the wide-angle (W) and telephoto (T) ends.
- After completing the adjustment, press the $\langle \text{MENU} \rangle$ button to return to the screen in step 1.
- Select [2: Adjust by lens], then press $\langle \text{SET} \rangle$.
- Press the $\langle \text{MENU} \rangle$ button to exit.

5 Check the result of the adjustment.

- Take a picture and play back the image (p.346) to check the adjustment result.
- If the shooting result comes out with focus in front of the targeted point, adjust toward the “+: ” side. If it comes out with focus behind the targeted point, adjust toward the “-: ” side.
- If necessary, repeat the adjustment.

 When shooting with the intermediate range (focal length) of a zoom lens, the AF's point of focus is corrected automatically relative to the adjustments made for the wide-angle and telephoto ends. Even if only the wide-angle or telephoto end has been adjusted, a correction will be made automatically for the intermediate range.

Clearing All AF Microadjustments

When [ **Clear all**] appears at the bottom of the screen, pressing the < > button will clear all the adjustments made for [1: **All by same amount**] and [2: **Adjust by lens**].

General Cautions for AF Microadjustment

- The AF's point of focus will vary slightly depending on the subject conditions, brightness, zoom position, and other shooting conditions. Therefore, even if you perform AF Microadjustment, focus may still not be achieved at the suitable position.
- The adjustment amount of one stop varies depending on the maximum aperture of the lens. Keep adjusting, shooting, and checking the focus repeatedly to adjust the AF's point of focus.
- The adjustment will not be applied to AF during Live View shooting or movie shooting.
- If you clear all the Custom Function settings (p.410), the AF Microadjustment will be retained. However, the setting will become [0: **Disable**].

Notes for AF Microadjustment



- It is best to make the adjustment at the actual location where you will shoot. This will make the adjustment more precise.
- Using a tripod when making the adjustment is recommended.
- For making adjustments, shooting at the  image-recording quality is recommended.

Custom Controls

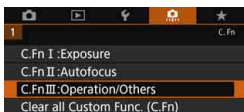
You can assign often-used functions to camera buttons or dials according to your preferences.



1 Select [C.Fn III: Operation/Others].

- Under the [] tab, select [C.Fn III: Operation/Others], then press < >.



2 Select [4: Custom Controls].

- The Custom Controls screen will appear.

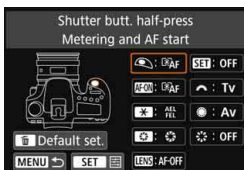

3 Select a camera button or dial.

- Select a camera button or dial, then press < >.
- The name of the camera control and the assignable functions will be displayed.
- The location of the camera control can be checked in the illustration on the left side of the screen.







4 Assign a function.

- Select a function, then press < >.





5 Exit the setting.

- When you press < > to exit the setting, the screen in step 3 will reappear.
- Press the <**MENU**> button to exit.

 With the screen in step 3 displayed, you can press the < > button to cancel the Custom Control settings. Note that the [ C.Fn III-4: Custom Controls] settings will not be canceled even if you select [ : Clear all Custom Func. (C.Fn)].

Assignable Functions to Camera Controls

Function		Page		AF-ON	
AF	AF	Metering and AF start	436	<input type="radio"/>	<input type="radio"/>
	AF-OFF	AF stop		<input type="radio"/>	<input type="radio"/>
	ONE SHOT AI SERVO/SERVO				
		AF point direct selection			
Exposure		Metering start	437	<input type="radio"/>	
	AEL FEL	AE lock/FE lock		<input type="radio"/>	<input type="radio"/>
		AE lock		<input type="radio"/>	<input type="radio"/>
		AE lock (while button pressed)		<input type="radio"/>	
		AE lock (hold)		<input type="radio"/>	<input type="radio"/>
	FEL	FE lock	438	<input type="radio"/>	<input type="radio"/>
	ISO	Set ISO speed (hold button, turn)			
		Exposure compensation (hold button, turn)			
	Tv	Shutter speed setting in M mode			
	Av	Aperture setting in M mode			
Flash		Flash exposure compensation	438		
		Flash function settings			
Images		Image quality	439		
		Picture Style			
	WB	White balance selection			
Operation		Depth-of-field preview	439		
		IS start			
	MENU	Menu display			
	OFF	No function (disabled)		<input type="radio"/>	<input type="radio"/>

	LENS*	SET			
	<input type="radio"/>				
<input type="radio"/>	<input type="radio"/>				
<input type="radio"/>	<input type="radio"/>				
					<input type="radio"/>
<input type="radio"/>	<input type="radio"/>				
<input type="radio"/>	<input type="radio"/>				
<input type="radio"/>	<input type="radio"/>				
<input type="radio"/>	<input type="radio"/>				
		<input type="radio"/>			
		<input type="radio"/>			
			<input type="radio"/>	<input type="radio"/>	
			<input type="radio"/>	<input type="radio"/>	
		<input type="radio"/>			
		<input type="radio"/>			
		<input type="radio"/>			
		<input type="radio"/>			
		<input type="radio"/>			
<input type="radio"/>					
<input type="radio"/>	<input type="radio"/>				
		<input type="radio"/>			
<input type="radio"/>		<input type="radio"/>			<input type="radio"/>

 * The AF stop button (**LENS**) is provided only on super telephoto IS lenses.

AF: Metering and AF start

When you press the button assigned to this function, metering and AF are executed.

AF-OFF: AF stop

The AF will stop while you hold down the button assigned to this function. Useful when you want to stop the AF during AI Servo AF.



ONE SHOT AI SERVO/SERVO

You can switch the AF operation. In One-Shot AF mode, when you hold down the button to which this function is assigned, the camera switches to AI Servo AF mode*. In the AI Servo AF mode, the camera switches to One-Shot AF mode only while you hold down the button. Useful when you need to keep switching between One-Shot AF and AI Servo AF for a subject that keeps moving and stopping.

* Servo AF mode for Live View shooting.

 This setting is disabled when Multi Shot Noise Reduction is set during Live View shooting.

AF point direct selection

During metering, you can select an AF point directly with  without pressing the  or  button.

 **Metering start**

When you press the shutter button halfway, exposure metering is performed (AF is not performed).

AEL
FEL **AE lock/FE lock**
Normal shooting (No flash)

When you press the button assigned to this function, you can lock the exposure (AE lock) during the metering. Useful when you want to focus and meter the shot at different areas or when you want to take multiple shots at the same exposure setting.

With flash

During flash photography, pressing the button assigned to this function will fire a preflash and record the required flash output (FE lock).

 **AE lock**

When you press the button assigned to this function, you can lock the exposure (AE lock) during the metering. Useful when you want to focus and meter the shot separately.

 **AE lock (while button pressed)**

The exposure will be locked (AE lock) while you press the shutter button.

 **AE lock (hold)**

When you press the button assigned to this function, you can lock the exposure (AE lock). The AE lock will be maintained until you press the button again. Useful when you want to focus and meter the shot separately or when you want to take multiple shots at the same exposure setting.

FEL: FE lock

For flash photography, pressing the button assigned to this function will fire a preflash and record the required flash output (FE lock).

ISO : Set ISO speed (hold button, turn)

You can set the ISO speed by holding down $\langle \text{SET} \rangle$ and turning the $\langle \text{ISO dial} \rangle$ dial. If this control is used while ISO Auto is set, manual ISO speed setting will take effect. If you use this function in the $\langle \mathbf{M} \rangle$ mode, you can adjust the exposure with the ISO speed while maintaining the current shutter speed and aperture.

: Exposure compensation (hold button, turn)

You can set the exposure compensation by holding down $\langle \text{SET} \rangle$ and turning the $\langle \text{Exposure compensation dial} \rangle$ dial. Useful when you want to set exposure compensation in $\langle \mathbf{M} \rangle$ manual exposure with ISO Auto set.

Tv: Shutter speed setting in M mode

In manual exposure $\langle \mathbf{M} \rangle$, you can set the shutter speed with the $\langle \text{Shutter speed dial} \rangle$ or $\langle \text{Exposure compensation dial} \rangle$ dial.

Av: Aperture setting in M mode

In manual exposure $\langle \mathbf{M} \rangle$, you can set the aperture with the $\langle \text{Aperture dial} \rangle$ or $\langle \text{Exposure compensation dial} \rangle$ dial.

: Flash exposure compensation

Press $\langle \text{SET} \rangle$ to display the exposure compensation setting screen (p.230) for the attached (built-in or external) flash unit on the LCD monitor.

: Flash function settings

Press $\langle \text{SET} \rangle$ to display the flash function setting screen (p.237) on the LCD monitor.

: Image quality

Press < > to display the image-recording quality setting screen (p.142) on the LCD monitor.

: Picture Style

Press < > to display the Picture Style selection setting screen on the LCD monitor (p.154).

WB: White balance selection

Press < > to display the white balance setting screen (p.162) on the LCD monitor.

: Depth-of-field preview

When you press the depth-of-field preview button, the aperture will stop down and you can check the depth of field (p.195).

: IS start

If you press the button assigned to this function when the lens's IS switch is set to <ON>, the lens's Image Stabilizer will operate.

MENU: Menu display

Press < > to display the menu on the LCD monitor.

OFF: No function (disabled)

Use this setting when you do not want to assign any function to the button.

MENU Registering My Menu ☆

Under My Menu tab, you can register menu items and Custom Functions whose settings you change frequently. You can also name the registered menu tabs and press the <MENU> button to display the My Menu tab first.

Creating and Adding My Menu Tab

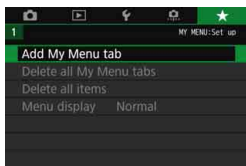

- 1 Select [Add My Menu tab].
 - Under the [★] tab, select [Add My Menu tab], then press <SET>.

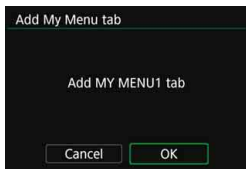

- 2 Select [OK].
 - ▶ The [MY MENU1] tab is created.
 - You can create up to five menu tabs by repeating steps 1 and 2.

Registering Menu Items under the My Menu Tab(s)

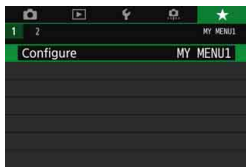

- 1 Select [Configure: MY MENU*].
 - Turn the <DIAL> dial to select [Configure: MY MENU*] (tab for registering menu items), then press <SET>.

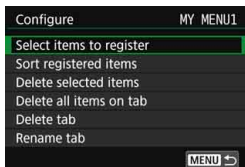

2 Select [Select items to register].

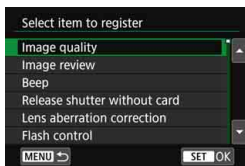

3 Register the desired items.

- Select the desired item, then press <SET>.
- Select [OK] on the confirmation dialog.
- You can register up to six items.
- To return to the screen in step 2, press the <MENU> button.

My Menu Tab Settings

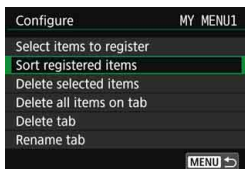

You can sort and delete items under the menu tab, and rename or delete the menu tab.

• Sort registered items

You can change the order of the registered items in My Menu. Select [**Sort registered items**] and select the item whose order you want to change. Then press <SET>. With [◆] displayed, press the <▲> <▼> keys to change the order, then press <SET>.

• Delete selected items / Delete all items on tab

You can delete any of the registered items. [**Delete selected items**] deletes one item at a time, and [**Delete all items on tab**] deletes all registered items.

- **Delete tab**

You can delete the My Menu tab currently displayed. Select [**Delete tab**] to delete the [**MY MENU***] tab.

- **Rename tab**

You can rename the My Menu tab from [**MY MENU***].

1 Select [Rename tab].



2 Enter text.

- Press the <☒> button to delete any unnecessary characters.
- Press the <Q> button to toggle between the top and bottom entry areas.
- Press the <▲> <▼> or <◀> <▶> keys to move the and select the desired character. Then press <SET> to enter it.
- By selecting [Aa=1@] and pressing <SET>, you can change the input mode.
- To cancel the text entry, press the <INFO.> button, then select [OK] on the confirmation screen.
- You can enter up to 16 characters.

3 Exit the setting.

- After entering the text, press the <MENU> button, then select [OK].
- ▶ The name is saved.

Deleting All My Menu Tabs / Deleting All Items

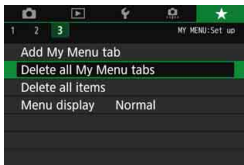

You can delete all My Menu tabs or all My Menu items you created.

- **Delete all My Menu tabs**

You can delete all My Menu tabs you created. When you select [**Delete all My Menu tabs**], all the tabs from [**MY MENU1**] to [**MY MENU5**] will be deleted and the [**★**] tab will revert to its default.

- **Delete all items**

You can delete all the items registered under the [**MY MENU1**] to [**MY MENU5**] tabs and keep the tabs. The menu tab(s) will remain. When [**Delete all items**] is selected, all the items registered under all the created tabs will be deleted.





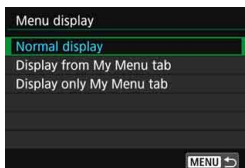

If you perform [**Delete tab**] or [**Delete all My Menu tabs**], tab names renamed with [**Rename tab**] will also be deleted.

Menu Display Settings



You can select [**Menu display**] to set the menu screen that is to appear first when you press the <**MENU**> button.

- **Normal display**
Displays the last displayed menu screen.
- **Display from My Menu tab**
Displays with the [**★**] tab selected.
- **Display only My Menu tab**
Only the [**★**] tab is displayed. (The , , , and  tabs will not be displayed.)

C1: Registering Custom Shooting Modes [☆]

You can register current camera settings, such as the shooting mode, menu functions, and Custom Function settings, as Custom shooting modes under the Mode Dial's **<C1>** and **<C2>** positions.

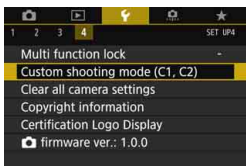

1 Select [Custom shooting mode (C1, C2)].

- Under the [**4**] tab, select [Custom shooting mode (C1, C2)], then press **<SET>**.

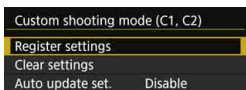

2 Select [Register settings].

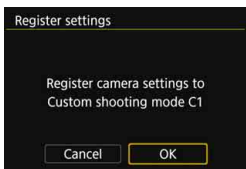

3 Register the Custom shooting mode.

- Select the Custom shooting mode to be registered, then press **<SET>**.
- Select **[OK]** on the confirmation dialog.
- ▶ The current camera settings (p.446) will be registered under the Mode Dial's **C*** position.

Automatic Update of Registered Settings

If you change a setting while shooting in the **<C1>** or **<C2>** mode, the respective Custom shooting mode can be automatically updated to reflect the changes in settings. To enable this automatic update, in step 2, set **[Auto update set.]** to **[Enable]**.

Canceling Registered Custom Shooting Modes













If you select **[Clear settings]** in step 2, the settings for respective modes can be reverted to the default settings with no Custom shooting modes registered.









Settings To Be Registered

● Shooting functions





Shooting mode, Shutter speed, Aperture, ISO speed, AF operation, AF area selection mode, AF point, Drive mode, Metering mode, Exposure compensation amount, Flash exposure compensation amount

● Menu functions





- [1] Image quality, Image review time, Beep, Release shutter without card, Lens aberration correction, Flash firing, E-TTL II flash metering, Flash sync speed in Av mode, Red-eye reduction
- [2] Exposure compensation/AEB, ISO speed settings, Auto Lighting Optimizer, White balance, White balance shift/bracketing, Color space
- [3] Picture Style, Long exposure noise reduction, High ISO speed noise reduction, Highlight tone priority, Multiple exposure (settings), HDR Mode (settings)
- [4] Interval timer, Bulb timer, Anti-flicker shooting, Mirror lockup, Aspect ratio
- [5 (Live View shooting)] Live View shooting, AF method, Touch shutter, Grid display, Exposure simulation
- [6 (Live View shooting)] Silent LV shooting, Metering timer
- [4 (Movie shooting)] Movie Servo AF, AF method, Movie recording quality, Digital zoom, Sound recording, Movie Servo AF speed, Movie Servo AF tracking sensitivity
- [5 (Movie shooting)] Metering timer, Grid display,  button function, Video snapshot, Time-lapse movie (settings), Remote control shooting
- [2] Slide show (settings), Image jump with 
- [3] Highlight alert, AF point display, Playback grid, Histogram display

- [1] File numbering, Auto rotate
- [2] Auto power off, LCD brightness, LCD off/on button, Viewfinder display
- [3] Touch control, Auto cleaning, **INFO** button display options
- [4] Multi function lock
- [1] Exposure level increments, ISO speed setting increments, Bracketing auto cancel, Bracketing sequence, Number of bracketed shots, Safety shift
- [2] Tracking sensitivity, Acceleration/deceleration tracking, AF point auto switching, AI Servo 1st image priority, AI Servo 2nd image priority, AF-assist beam firing, Lens drive when AF impossible, Select AF area selection mode, AF area selection method, Orientation linked AF point, Initial AF point,  AI Servo AF, Auto AF point selection: Color Tracking, AF point selection pattern, AF point display during focus, Viewfinder display illumination, AF Microadjustment
- [3] Dial direction during Tv/Av, Retract lens on power off, Custom Controls



- My Menu settings will not be registered under Custom shooting modes.
- When the Mode Dial is set to <1> or <2>, you cannot select [4: **Clear all camera settings**] or [: **Clear all Custom Func. (C.Fn)**].



- Even when the Mode Dial is set to <1> or <2>, you can still change shooting function settings and menu settings.
- By pressing the <**INFO**> button, you can check which shooting mode is registered under <1> and <2> (p.450-451).

13

Reference

This chapter provides reference information for camera features, system accessories, etc.



Certification Logo

Select [**4: Certification Logo Display**] and press <SET> to display some of the logos of the camera's certifications. Other certification logos can be found in this Instruction Manual, on the camera body, and on the camera's package.

INFO. Button Functions



When you press the <INFO.> button while the camera is ready to shoot, you can display [Displays camera settings], [Electronic level] (p.72), and [Displays shooting functions] (p.451).



Under the [F3] tab, [INFO button display options] enables you to select the options displayed when the <INFO.> button is pressed.

- Select the desired display option and press <SET> to add a checkmark [✓].
- After completing the selections, select [OK].

- Note that you cannot remove the [✓] for all three display options.
- The [Displays camera settings] sample screen is displayed in English for all languages.
- Even if you uncheck the [Electronic level] so it does not appear, it will still appear for Live View shooting and movie shooting when you press the <INFO.> button.

Camera Settings

Shooting mode registered under the Mode Dial's [C1] [C2]

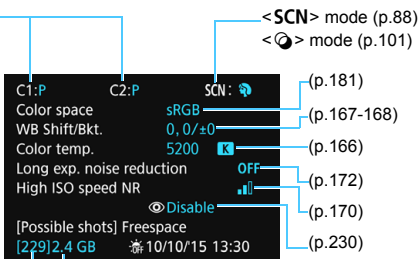

(p.37, 143)

Shooting Function Settings

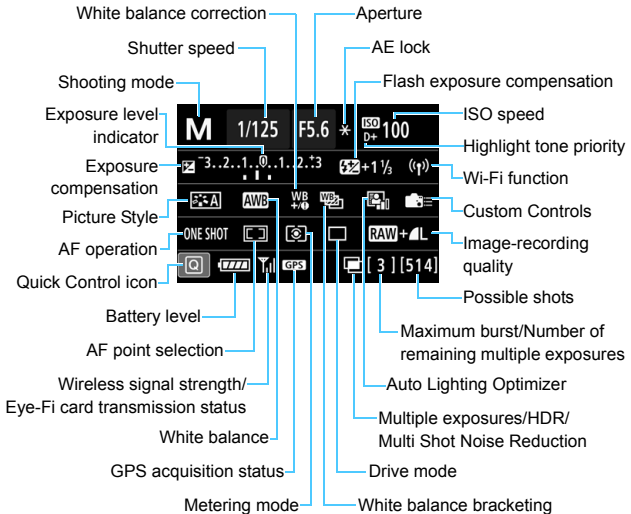

- Pressing the $\langle \text{Q} \rangle$ button enables Quick Control of the shooting settings (p.56).
- When you press the $\langle \text{AF} \rangle$, $\langle \text{DRIVE} \rangle$, $\langle \text{ISO} \rangle$, $\langle \text{METER} \rangle$, $\langle \text{AF POINT} \rangle$, or $\langle \text{CUSTOM} \rangle$ button, the setting screen will appear and you can use $\langle \text{WIRELESS} \rangle$, $\langle \text{BATTERY} \rangle$, $\langle \text{GPS} \rangle$, and $\langle \text{CUSTOM} \rangle$ to set the function.



If you turn off the power while the “Shooting function settings display” screen is displayed, the same screen will be displayed when you turn on the power again. To cancel this, press the $\langle \text{INFO.} \rangle$ button to exit from “Shooting function settings display” screen, then turn off the power switch.

MENU Checking the Battery Information

You can check the condition of the battery you are using on the LCD monitor. Each Battery Pack LP-E6N/LP-E6 has a unique serial number, and you can register multiple batteries to the camera. When you use this feature, you can check the registered batteries' remaining capacity and operation history.

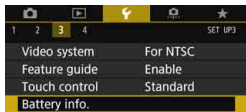

Battery position

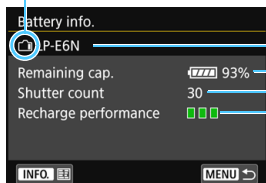

Select [Battery info.].

- Under the [**3**] tab, select [**Battery info.**], then press <[SET]>.
- ▶ The battery info. screen will appear.

Battery model or household power source being used.

The battery level indicator (p.42) is displayed together with the remaining battery level shown in 1% increments.

The number of shots taken with the current battery. The number is reset when the battery is recharged.

Battery's recharge performance level is displayed in one of three levels.

- (Green): Battery's recharge performance is fine.
- (Green): Battery's recharge performance is slightly degraded.
- (Red) : Purchasing a new battery is recommended.

⚠ Using a genuine Canon Battery Pack LP-E6N/LP-E6 is recommended. If you use batteries that are not genuine Canon products, this camera's full performance may not be attained or malfunction may result.

- The shutter count is the number of still photos taken. (Movies are not counted.)
- The battery information will also be displayed when Battery Pack LP-E6N/LP-E6 is used with Battery Grip BG-E14 (sold separately). If AA/R6 batteries are used, only the remaining battery level will be displayed.
- If a battery communication error message is displayed, follow the message.

Registering Batteries to the Camera

You can register up to six LP-E6N/LP-E6 batteries to the camera. To register multiple batteries to the camera, follow the procedure below for each battery.

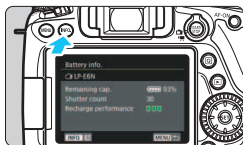

1 Press the <INFO.> button.

- With the battery info. screen displayed, press the <INFO.> button.
- ▶ The battery history screen will appear.
- ▶ If the battery is not registered, it will be grayed out.

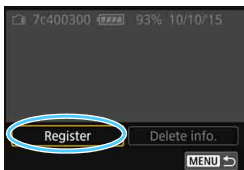

2 Select [Register].

- ▶ The confirmation dialog will appear.

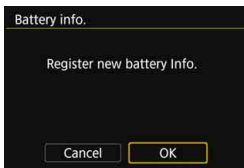

3 Select [OK].

- ▶ The battery will be registered and the battery history screen will reappear.
- ▶ The grayed out battery number will now be displayed in white.
- Press the <MENU> button. The battery info. screen will reappear.



- The battery cannot be registered if Battery Grip BG-E14 (sold separately) using AA/R6 batteries is attached or the camera is powered by AC Adapter Kit ACK-E6 (sold separately).
- If six batteries are already registered, [Register] cannot be selected. To delete unnecessary battery information, see page 455.

Labeling the Serial Number on the Battery

It is convenient to label each registered Battery Pack LP-E6N/LP-E6 with their serial numbers, using commercially-available labels.

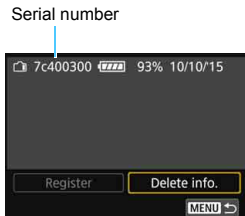

1 Write the serial number on a label.

- Write the serial number displayed on the battery history screen on a label approx. 25 mm x 15 mm / 1.0 in. x 0.6 in. in size.

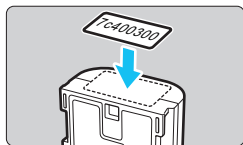

2 Remove the battery and affix the label.

- Set the power switch to <OFF>.
- Open the battery compartment cover and remove the battery.
- Affix the label as shown in the illustration (on the side with no electrical contacts).
- Repeat this procedure for all of your batteries so you can easily see the serial number.

- Do not affix the label on any part other than as shown in the illustration in step 2. Otherwise, the misplaced label may make it difficult to insert the battery or impossible to turn on the camera.
- If you use Battery Grip BG-E14 (sold separately), the label may peel off as you repeatedly insert and remove the battery. If it peels off, affix a new label.

Checking the Remaining Capacity of a Registered Battery

You can check the remaining capacity of any battery (even when not installed) and also when it was last used.

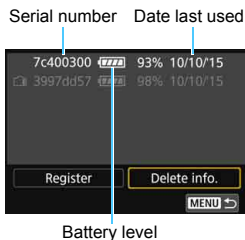

Look for the serial number.

- Match the battery's serial number on the battery history screen with the battery's serial number label.
- ▶ You can check the respective battery's remaining capacity and the date when it was last used.

Deleting the Registered Battery Information

1 Select [Delete info.].

- Follow step 2 on page 453 to select [Delete info.], then press <SET>.

2 Select the battery information to be deleted.

- Select the battery information to be deleted, then press <SET>.
- ▶ [✓] will appear.
- To delete information for another battery, repeat this procedure.

3 Press the <trash> button.

- ▶ The confirmation dialog will appear.

4 Select [OK].

- ▶ The battery information will be deleted and the screen in step 1 will reappear.

Using a Household Power Outlet

You can power the camera with a household power outlet by using the DC Coupler DR-E6 and AC Adapter AC-E6N (both sold separately).

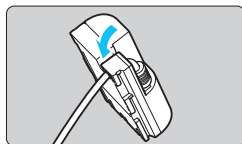

1 Place the cord in the groove.

- Insert the DC coupler's cord carefully without damaging the cord.

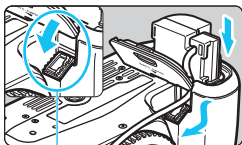

DC coupler cord hole

2 Insert the DC coupler.

- Open the battery compartment cover and open the DC coupler cord hole cover.
- Insert the DC coupler securely until it locks and put the cord through the hole.
- Close the cover.

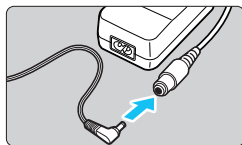

3 Connect the DC coupler's plug.

- Connect the DC coupler's plug and the AC adapter's connector securely.

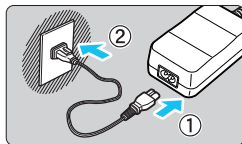

4 Connect the power cord.

- Connect the power cord as shown in the illustration.
- After using the camera, unplug the power plug from the power outlet.

 Do not connect or disconnect the power cord or DC coupler while leaving the camera's power switch set to the <ON> position.

 AC Adapter Kit ACK-E6 (sold separately) can also be used.

Using Eye-Fi Cards

With a commercially-available Eye-Fi card already set up, you can automatically transfer captured images to a computer or upload them to an online service via a wireless LAN.

The image transfer is a function of the Eye-Fi card. For instructions on how to set up and use the Eye-Fi card or to troubleshoot any image transfer problems, refer to the Eye-Fi card's instruction manual or contact the card manufacturer.

 **The camera is not guaranteed to support Eye-Fi card functions (including wireless transfer). In case of a problem with an Eye-Fi card, please check with the card manufacturer. Also note that approval is required to use Eye-Fi cards in many countries or regions. Without approval, use of the card is not permitted. If it is unclear whether the card has been approved for use in your area, please check with the card manufacturer.**

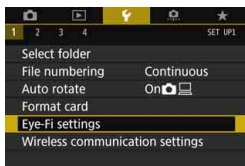

1 Insert an Eye-Fi card (p.37).



2 Select [Eye-Fi settings].

- Under the [**1**] tab, select [**Eye-Fi settings**], then press <  >.
- This menu is displayed only when an Eye-Fi card is inserted into the camera.

3 Enable Eye-Fi transmission.

- Select [**Eye-Fi trans.**], then press <  >.
- Select [**Enable**], then press <  >.
- If you set [**Disable**], there will be no automatic transmission even with the Eye-Fi card inserted (transmission status icon ).

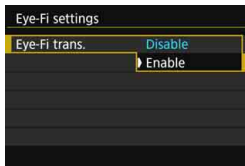

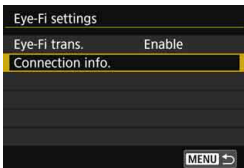

4 Display the connection information.

- Select [**Connection info.**], then press <SET>.

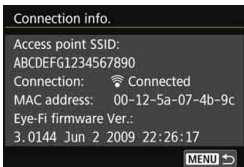

5 Check the [**Access point SSID:**].





- Check that an access point is displayed for [**Access point SSID:**].
- You can also check the Eye-Fi card's MAC address and firmware version.
- Press the <MENU> button to exit the menu.





Transmission status icon

6 Take the picture.

- ▶ The picture is transferred and the <Wi-Fi> icon switches from gray (not connected) to one of the icons below.
- For transferred images, [] is displayed in the shooting information display (p.348).

-  (Gray) **Not connected** : No connection with access point.
-  (Blinking) **Connecting...**: Connecting to access point.
-  (Illuminated) **Connected**: Connection to access point established.
-  (↑) **Transferring...** : Image transfer to access point in progress.

Cautions for Using Eye-Fi Cards

- If [Wi-Fi/NFC] under [**1: Wireless communication settings**] is set to [Enable], image transfer with an Eye-Fi card is not possible.
- If “” is displayed, an error occurred while retrieving the card information. Turn the camera's power switch off and on again.
- Even if [Eye-Fi trans.] is set to [Disable], it may still transmit a signal. In hospitals, airports, and other places where wireless transmissions are prohibited, remove the Eye-Fi card from the camera.
- If the image transfer does not function, check the Eye-Fi card and computer settings. For details, refer to the card's instruction manual.
- Depending on the wireless LAN's connection conditions, the image transfer may take longer or it may be interrupted.
- The Eye-Fi card may become hot as it transmits.
- The camera's battery power will be consumed faster.
- During the image transfer, auto power off will not take effect.
- If you insert a wireless LAN card other than an Eye-Fi card, [Eye-Fi settings] will not appear. Also, the transmission status icon < > will not appear.

Function Availability Table by Shooting Mode

Still Photo Shooting in Basic Zone Modes: SCN

●: Set automatically ○: User selectable □: Not selectable/Disabled

Function					SCN									
Image quality settings selectable		○	○	○	○	○	○	○	○	○*	○*	○	○	○
Aspect ratio														
ISO speed	Automatically set/Auto	●	●	●	●	●	●	●	●	●	●	●	●	●
	Manually set													
Picture Style	Automatically set													
	Manual selection													
Ambience-based shots				○	○	○	○	○	○		○	○	○	○
Lighting/scene based shots						○					○	○	○	○
Background blur				○										
Color tone					○		○							
White balance	Auto													
	Preset													
	Custom													
	Correction/Bracketing													
Auto Lighting Optimizer		●	●	●	●	●	●	●	●	●	●	●	●	●
Lens aberration correction	Peripheral illumination correction	●	●	●	●	●	●	●	●	●	●	●	●	●
	Chromatic aberration correction	●	●	●	●	●	●	●	●	●	●	●	●	●
	Distortion correction													
Long exposure noise reduction														
High ISO speed noise reduction		●	●	●	●	●	●	●	●	●	●	●	●	●
Highlight tone priority														
Anti-flicker shooting ^{*2}		●	●	●	●	●	●	●	●	●	●	●	●	●
Color space	sRGB	●	●	●	●	●	●	●	●	●	●	●	●	●
	Adobe RGB													
Metering mode	Evaluative metering	●	●	●	●	●		●	●	●	●	●	●	●
	Center-weighted average metering						●							
	Metering mode selection													

*1: RAW+JPEG or RAW cannot be selected.































*2: Settable only with viewfinder shooting.

Function		A+	Q	CA	SCN											
					1	2	3	4	5	6	7	8	9	10	11	12
AF operation (Viewfinder shooting)	One-Shot AF				●		●	●	●	● ^{*3}	● ^{*3}	●	●			
	AI Servo AF					● ^{*3}								● ^{*3}		
	AI Focus AF	● ^{*3}	● ^{*3}	● ^{*3}												
AF operation (Live View shooting)	One-Shot AF	●	●	●	●			●	●	●	●	●	●	●		
	Servo AF					●								●		
AF	AF area selection mode															
	AF point	●	●	●	●	●	●	●	●	●	●	●	●	●		
	AF-assist beam	●		●	●		●	●	●	●	●		●			
	AF Microadjustment ²															
Exposure	Program shift															
	Exposure compensation															
	AEB															
	AE lock															
	Depth-of-field preview															
	HDR shooting															
	Multiple exposure															
	Interval timer ²	○	○	○	○	○	○	○	○	○	○	○	○	○		
Drive	Single shooting	○	○	○	○	○	○	○	○	○	○	○	○	○		
	High-speed continuous shooting	○	○	○	○	○	○	○	○	○	○	○	○	○		
	Low-speed continuous shooting	○	○	○	○	○	○	○	○	○	○	○	○	○		
	Silent single shooting ²	○	○	○	○	○	○	○	○	○	○	○	○	○		
	Silent continuous shooting ²	○	○	○	○	○	○	○	○	○	○	○	○	○		
	Self-timer: 10 sec./remote control	○	○	○	○	○	○	○	○	○	○	○	○	○		
	Self-timer: 2 sec./remote control	○	○	○	○	○	○	○	○	○	○	○	○	○		
Built-in flash	Automatic firing	○		○		○		●			○		○			
	Flash on (Fires at all times)	○		○	○	○				○		○		○		
	Flash off	○	●	○	○	○	○	●		○	●	○	●	○		
	Red-eye reduction	○		○	○	○		○	○		○		○			
	FE lock ²															
	Flash exposure compensation															
	Wireless control															
External flash	Flash on (Fires at all times)	●		●	●	●	●	●	●		●	●	●	●		
	Flash off		●							●						
	Function settings															
	Custom Function settings															
Live View shooting		○	○	○	○	○	○	○	○	○	○	○	○	○		
Quick Control		○	○	○	○	○	○	○	○	○	○	○	○	○		

*3: AF will be performed using color tracking.











Still Photo Shooting in Basic Zone Modes: 

●: Set automatically ○: User selectable □: Not selectable/Disabled

Function											
											
Image quality settings selectable*1		○	○	○	○	○	○	○	○	○	○
Aspect ratio											
ISO speed	Automatically set/Auto	●	●	●	●	●	●	●	●	●	●
	Manually set										
Picture Style	Automatically set										
	Manual selection										
Ambience-based shots											
Lighting/scene based shots											
Background blur											
Color tone											
White balance	Auto										
	Preset										
	Custom										
	Correction/Bracketing										
Auto Lighting Optimizer											
Lens aberration correction	Peripheral illumination correction	●	●	●	●	●	●	●	●	●	●
	Chromatic aberration correction	●	●	●	●	●	●	●	●	●	●
	Distortion correction										
Long exposure noise reduction											
High ISO speed noise reduction		●	●	●	●	●	●	●	●	●	●
Highlight tone priority											
Anti-flicker shooting*2		●	●	●	●	●	●	●	●	●	●
Color space	sRGB	●	●	●	●	●	●	●	●	●	●
	Adobe RGB										
Metering mode	Evaluative metering	●	●		●	●	●	●	●	●	●
	Center-weighted average metering			●							
	Metering mode selection										

*1: RAW+JPEG or RAW cannot be selected.

*2: Settable only with viewfinder shooting.

Function											
											
AF operation (Viewfinder shooting)	One-Shot AF							●*3	●*3	●*3	●*3
	AI Servo AF										
	AI Focus AF	●*3	●*3	●	●*3	●	●*3				
AF operation (Live View shooting)	One-Shot AF	●	●	●	●	●	●	●	●	●	●
	Servo AF										
AF	AF area selection mode										
	AF point	●	●	●	●	●	●	●	●	●	●
	AF-assist beam	●	●	●	●	●	●	●	●	●	●
	AF Microadjustment ^{*2}										
Exposure	Program shift										
	Exposure compensation										
	AEB										
	AE lock										
	Depth-of-field preview										
	HDR shooting										
	Multiple exposure										
	Interval timer ^{*2}	○	○	○	○	○	○	○	○	○	○
Drive	Single shooting	○	○	○	○	○	○	○	○	○	○
	High-speed continuous shooting							○	○	○	○
	Low-speed continuous shooting							○	○	○	○
	Silent single shooting ^{*2}	○	○	○	○	○	○	○	○	○	○
	Silent continuous shooting ^{*2}							○	○	○	○
	Self-timer: 10 sec./remote control	○	○	○	○	○	○	○	○	○	○
	Self-timer: 2 sec./remote control	○	○	○	○	○	○	○	○	○	○
Built-in flash	Automatic firing	○	○	○	○	○					
	Flash on (Fires at all times)	○	○	○	○	○					
	Flash off	○	○	○	○	○	○	●	●	●	●
	Red-eye reduction	○	○	○	○	○	○				
	FE lock ^{*2}										
	Flash exposure compensation										
	Wireless control										
External flash	Flash on (Fires at all times)	●	●	●	●	●					
	Flash off						●	●	●	●	
	Function settings										
	Custom Function settings										
Live View shooting	○	○	○	○	○	○	○	○	○	○	○
Quick Control	○	○	○	○	○	○	○	○	○	○	○

*3: AF will be performed using color tracking.

Still Photo Shooting in Creative Zone Modes

●: Set automatically ○: User selectable □: Not selectable/Disabled

Function		P	Tv	Av	M	B
Image quality settings selectable		○	○	○	○	○
Aspect ratio		○	○	○	○	○
ISO speed	Automatically set/Auto	○	○	○	○	○
	Manually set	○	○	○	○	○
Picture Style	Automatically set	○	○	○	○	○
	Manual selection	○	○	○	○	○
Ambience-based shots						
Lighting/scene based shots						
Background blur						
Color tone						
Creative filters ^{*1,2}		○	○	○	○	○
White balance	Auto	○	○	○	○	○
	Preset	○	○	○	○	○
	Custom	○	○	○	○	○
	Correction/Bracketing	○	○	○	○	○
Auto Lighting Optimizer		○	○	○	○	○
Lens aberration correction	Peripheral illumination correction	○	○	○	○	○
	Chromatic aberration correction	○	○	○	○	○
	Distortion correction	○	○	○	○	○
Long exposure noise reduction		○	○	○	○	○
High ISO speed noise reduction		○	○	○	○	○
Highlight tone priority		○	○	○	○	○
Anti-flicker shooting ^{*3}		○	○	○	○	○
Color space	sRGB	○	○	○	○	○
	Adobe RGB	○	○	○	○	○
Metering mode	Evaluative metering	○	○	○	○	○
	Metering mode selection	○	○	○	○	○

*1: RAW+JPEG or RAW cannot be selected.

*2: Settable only during Live View shooting.

*3: Works only during viewfinder shooting.

Function		P	Tv	Av	M	B
AF operation (Viewfinder shooting)	One-Shot AF	○	○	○	○	○
	AI Servo AF	○	○	○	○	○
	AI Focus AF	○	○	○	○	○
AF operation (Live View shooting)	One-Shot AF	○	○	○	○	○
	Servo AF	○	○	○	○	○
AF	AF area selection mode ^{*3}	○	○	○	○	○
	AF point	○	○	○	○	○
	AF-assist beam	○	○	○	○	○
	AF Microadjustment ^{*3}	○	○	○	○	○
Exposure	Program shift	○				
	Exposure compensation	○	○	○	*4	
	AEB	○	○	○	○	
	AE lock	○	○	○	*5	
	Depth-of-field preview	○	○	○	○	○
	HDR shooting	○	○	○	○	
	Multiple exposure	○	○	○	○	○
	Interval timer ^{*3}	○	○	○	○	
Drive mode	Bulb timer					○
	Single shooting	○	○	○	○	○
	High-speed continuous shooting	○	○	○	○	○
	Low-speed continuous shooting	○	○	○	○	○
	Silent single shooting ^{*3}	○	○	○	○	○
	Silent continuous shooting ^{*3}	○	○	○	○	○
	Self-timer: 10 sec./remote control	○	○	○	○	○
Self-timer: 2 sec./remote control	○	○	○	○	○	
Built-in flash	Automatic firing					
	Flash on (Fires at all times)	○	○	○	○	○
	Flash off	○	○	○	○	○
	Red-eye reduction	○	○	○	○	○
	FE lock ^{*3}	○	○	○	○	○
	Flash exposure compensation	○	○	○	○	○
External flash	Wireless control	○	○	○	○	○
	Flash on (Fires at all times)	○	○	○	○	○
	Flash off	○	○	○	○	○
	Function settings	○	○	○	○	○
Custom Function settings	○	○	○	○	○	
Live View shooting	○	○	○	○	○	
Quick Control	○	○	○	○	○	

*4: Settable only when ISO Auto is set.

*5: With ISO Auto, you can set a fixed ISO speed.

Movie Shooting

●: Set automatically ○: User selectable □: Not selectable/Disabled

Function						P	Tv	Av	B	M
Movie recording sizes selectable	○	○	○	○	○	○	○	○	○	○
Digital zoom	○	○	○	○		○	○	○	○	○
HDR movie shooting	○	○	○	○						
Creative filters					○	○	○	○	○	○
Video snapshot	○	○	○	○		○	○	○	○	○
Time-lapse movie	○	○	○	○		○	○	○	○	○
ISO speed	Automatically set/Auto	●	●	●	●	●	●	●	●	○
	Manually set									○
Picture Style	Automatically set					○	○	○	○	○
	Manual selection						○	○	○	○
White balance	Auto					○	○	○	○	○
	Preset					○	○	○	○	○
	Custom					○	○	○	○	○
	Correction					○	○	○	○	○
Auto Lighting Optimizer	●	●	●	●		○	○	○	○	○
Lens aberration correction	Peripheral illumination correction	●	●	●	●	○	○	○	○	○
	Chromatic aberration correction	●	●	●	●	○	○	○	○	○
	Distortion correction									
High ISO speed noise reduction	●	●	●	●	●	○	○	○	○	○
Highlight tone priority						○	○	○	○	○

Function					SCN		P	Tv	Av	B	M
Metering mode		●	●	●	●	●	●	●	●	●	●
AF	Face+Tracking	○	○	○	○	○	○	○	○	○	○
	FlexiZone - Multi	○	○	○	○	○	○	○	○	○	○
	FlexiZone - Single	○	○	○	○	○	○	○	○	○	○
	Manual focus (MF)	○	○	○	○	○	○	○	○	○	○
	Movie Servo AF	○	○	○	○	○	○	○	○	○	○
Exposure	Program shift										
	Exposure compensation						○	○	○	○	*1
	AE lock						○	○	○	○	*2
	Depth-of-field preview										
Aspect ratio											
Sound recording		○	○	○	○	○	○	○	○	○	○
Quick Control		○	○	○	○	○	○	○	○	○	○

*1: Settable only when ISO Auto is set.

*2: With ISO Auto, you can set a fixed ISO speed.

System Map

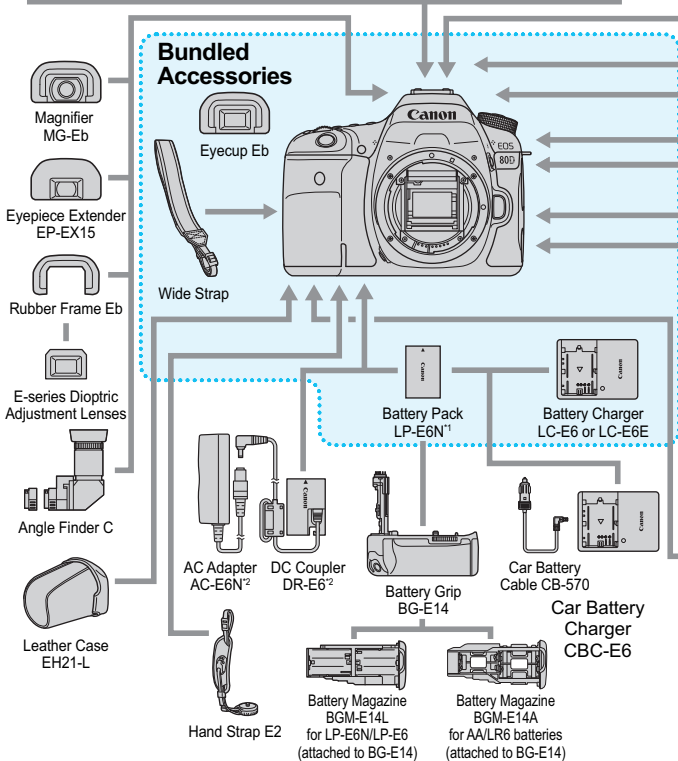
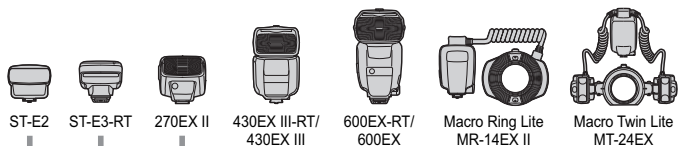

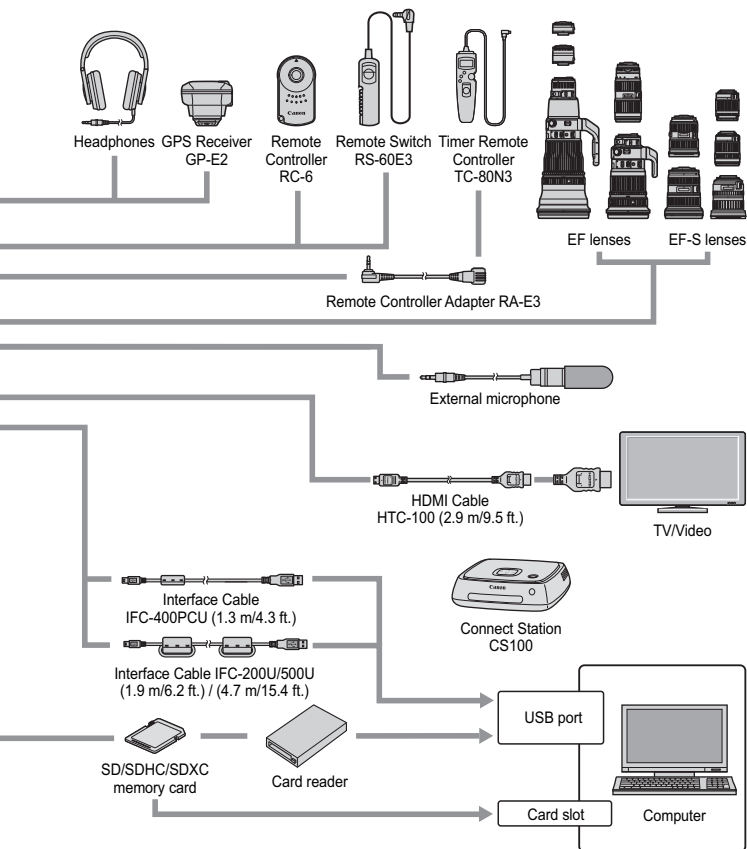

*1: Battery Pack LP-E6 can also be used.

*2: AC Adapter Kit ACK-E6 can also be used.

* Wireless File Transmitter WFT-E7 (Ver.2), WFT-E7 cannot be used.

* All cable lengths given are approximate figures.

MENU Menu Settings

Viewfinder Shooting and Live View Shooting

📷: Shooting 1 (Red)

Page

Image quality	RAW* / M RAW* / S RAW*	142
	▲ L / ▲ L / ▲ M / ▲ M / ▲ S1 / ▲ S1 / S2 / S3	
Image review	Off / 2 sec. / 4 sec. / 8 sec. / Hold	67
Beep	Enable / Touch to 🗨 / Disable	66
Release shutter without card	Enable / Disable	38
Lens aberration correction	Peripheral illumination correction: Enable / Disable	175
	Chromatic aberration correction: Enable / Disable	
	Distortion correction: Disable / Enable	
Flash control	Flash firing / E-TTL II metering / Flash sync. speed in Av mode / Built-in flash settings / External flash function settings / External flash C.Fn setting / Clear settings	235
Red-eye reduction	Disable / Enable	230

* Not selectable in the <SCN: 📷 📷> and <📷> modes.

 Shaded menu options are not displayed in Basic Zone modes.

📷: Shooting 2 (Red)

Page

Exposure compensation/AEB	1/3- and 1/2-stop increments, ± 5 stops* (AEB ± 3 stops)	200 201
ISO speed settings	ISO speed / Range for stills / Auto range / Minimum shutter speed for auto	148
Auto Lighting Optimizer	Disable / Low / Standard / High	169
	Disabled in M or B modes	
White balance	AWB (Ambience priority) / AWB w (White priority) / ☀️/🏠/☁️/☀️/🌅/🌃/🌃/🌃/ Ⓚ (Approx. 2500 - 10000)	162
Custom White Balance	Manual setting of white balance	164
White balance shift/ bracketing	White balance correction: B/A/M/G bias, 9 levels each	167
	White balance bracketing: B/A and M/G bias, single-level increments, ± 3 levels	
Color space	sRGB / Adobe RGB	181

* During Live View shooting, exposure compensation can be set up to ± 3 stops.

📷: Shooting 3 (Red)

Picture Style	Auto / Standard / Portrait / Landscape / Fine Detail / Neutral / Faithful / Monochrome / User Def. 1-3	154
Long exposure noise reduction	Disable / Auto / Enable	172
High ISO speed noise reduction	Disable / Low / Standard / High / Multi Shot Noise Reduction	170
Highlight tone priority	Disable / Enable	174
Dust Delete Data	Obtain data to be used by Digital Photo Professional (EOS software) to delete dust spots	405
Multiple exposure	Multiple exposure / Multiple exposure control / Number of exposures / Continue multiple exposure	212
HDR Mode	Adjust dynamic range / Effect / Continuous HDR / Auto Image Align	207

📷: Shooting 4* (Red)

Page

Interval timer	Disable / Enable (Interval / Number of shots)	223
Bulb timer	Disable / Enable (Exposure time)	205
Anti-flicker shooting	Disable / Enable	179
Mirror lockup	Disable / Enable	219
Aspect ratio	3:2 / 4:3 / 16:9 / 1:1	146

* In Basic Zone modes, these menu options are displayed under the [📷2] tab.

📷: Shooting 5* (Red)

Live View shooting	Enable / Disable	257
AF method	☺+Tracking / FlexiZone - Multi / FlexiZone - Single	276
Touch shutter	Disable / Enable	286
Grid display	Off / 3x3 卍 / 6x4 卐 / 3x3+diag 卐*	270
Exposure simulation	Enable / During 📷 / Disable	271

* In Basic Zone modes, these menu options are displayed under the [📷3] tab.

📷: Shooting 6 (Red)

Silent LV shooting	Mode 1 / Mode 2 / Disable	272
Metering timer	4 sec. / 8 sec. / 16 sec. / 30 sec. / 1 min. / 10 min. / 30 min.	273

▶: Playback 1 (Blue)



Page

Protect images	Protect images	376
Rotate image	Rotate images	358
Erase images	Erase images	378
Print order	Specify images to be printed (DPOF)	380
Photobook Set-up	Specify images for a photobook	384
Creative filters	Grainy B/W / Soft focus / Fish-eye effect / Art bold effect / Water painting effect / Toy camera effect / Miniature effect	399
RAW image processing	Process RAW images	390

▶: Playback 2 (Blue)



Cropping	Partially crop JPEG images	397
Resize	Downsize JPEG image's pixel count	395
Rating	[OFF] / [•] / [••] / [•••] / [••••] / [•••••]	359
Slide show	Playback description / Display time / Repeat / Transition effect / Background music	369
Image jump w/ 	1 image / 10 images / 100 images / Date / Folder / Movies / Stills / Rating	354

▶: Playback 3 (Blue)

Highlight alert	Disable / Enable	351
AF point display	Disable / Enable	352
Playback grid	Off / 3x3  / 6x4  / 3x3+diag 	347
Histogram display	Brightness / RGB	352
Control over HDMI	Disable / Enable	374

☛: Set-up 1 (Yellow)

Page

Select folder	Create and select a folder	182
File number	Continuous / Auto reset / Manual reset	184
Auto rotate	On   / On  / Off	387
Format card	Initialize and erase data on the card	64
Eye-Fi settings	Displayed when a commercially-available Eye-Fi card is inserted	457
Wireless communication settings	Wi-Fi/NFC: Disable / Enable Allow NFC connections	-*
	Wi-Fi function: Transfer images between cameras / Connect to smartphone / Remote control (EOS Utility) / Print from Wi-Fi printer / View images on DLNA devices / Upload to Web service	
	Send images to smartphone	
	Nickname	
	Clear Settings	



* For details, refer to the Wireless Function Instruction Manual.

☛: Set-up 2 (Yellow)

Auto power off	1 min. / 2 min. / 4 min. / 8 min. / 15 min. / 30 min. / Disable	66
LCD brightness	Adjust the brightness (seven levels)	386
LCD off/on button	Remains on / Shutter button	67
Date/Time/Zone	Date (year, month, day) / Time (hour, min., sec.) / Daylight saving time / Time zone	43
Language 	Select the interface language	46
Viewfinder display	Electronic level: Hide / Show	72
	Grid display: Hide / Show	71
	Flicker detection: Show / Hide	74
GPS device settings	Settings available when the GPS Receiver GP-E2 (sold separately) is attached	-

☛: Set-up 3 (Yellow)

Page

Video system	NTSC / PAL	307 373
Feature guide	Enable / Disable	75
Touch control	Standard / Sensitive / Disable	63
Battery information	Power / Remaining capacity / Shutter count / Recharge performance / Battery registration / Serial number / Battery history	452
Sensor cleaning	Auto cleaning  : Enable / Disable	404
	Clean now 	
	Clean manually	407
INFO button display options	Displays camera settings / Electronic level / Displays shooting functions	450
INFO button LV display options	Live View info switch setting: 1 / 2 / 3 / 4	262
	Histogram display: Brightness / RGB / Display size	263
	Reset	





- When using a wireless function or GPS device, be sure to check the countries and areas of use, and observe the laws and regulations of the country or region.
- Note that when connecting GPS Receiver GP-E2 (sold separately) with a cable, preparations as below are necessary.
 - Update the GP-E2's firmware to Version 2.0.0 or later. (Using the cable for connection is not possible with the firmware version earlier than Version 2.0.0.)
 - An interface cable (sold separately, p.469) must be used.

When using the GP-E2 attached to the hot shoe, preparations as above are not necessary. For how to update the GP-E2's firmware, refer to the Canon Web site.
- Wireless functions cannot be set if the camera is connected to a computer, GPS receiver, or another device with an interface cable.

☛: Set-up 4 (Yellow)

Page

Multi function lock	Main Dial	54
	Quick Control Dial	
	Multi-controller	
	Touch control	
Custom shooting mode (C1, C2)	Register current camera settings to the Mode Dial's  and  positions	445
Clear all camera settings	Resets the camera to the default settings	68
Copyright information	Display copyright information / Enter author's name / Enter copyright details / Delete copyright information	186
Certification Logo Display	Displays some of the logos of the camera's certifications	449
 firmware ver.*	For updating the firmware	-

* During firmware updates, the touch screen will be disabled to prevent accidental operations.

☛: Custom Functions (Orange)

C.Fn I: Exposure	Customize camera functions as desired	413
C.Fn II: Autofocus		416
C.Fn III: Operation/ Others		425
Clear all Custom Functions (C.Fn)	Clear all Custom Function settings	410

★: My Menu (Green)

Add My Menu tab	Add My Menu tabs 1-5	440
Delete all My Menu tabs	Delete all My Menu tabs	443
Delete all items	Delete all items under My Menu tabs 1-5	443
Menu display	Normal display / Display from My Menu tab / Display only My Menu tab	444

Movie Shooting

📷: Shooting 1 (Red)

Page

Image quality*	RAW / M RAW / S RAW	142
	📷 L / 📷 L / 📷 M / 📷 M / 📷 S1 / 📷 S1 / S2 / S3	
Image review	Off / 2 sec. / 4 sec. / 8 sec. / Hold	67
Beep	Enable / Touch to 📢 / Disable	66
Release shutter without card	Enable / Disable	38
Lens aberration correction	Peripheral illumination correction: Enable / Disable	175
	Chromatic aberration correction: Enable / Disable	

* Still photo shooting is not possible during movie shooting even if **[Image quality]** menu is displayed during movie shooting.



- Shaded menu options are not displayed in Basic Zone modes.
- The menu tabs and options displayed will differ between viewfinder shooting/Live View shooting and movie shooting. Note that the menu tabs and options displayed in [▶]1 Playback 1 to [▶]3 Playback 3, [👉]1 Set-up 1 to [👉]4 Set-up 4, [⚙️] Custom Functions, and [★] My Menu are the same as those displayed in viewfinder shooting/Live View shooting (p.473-476).

📷: Shooting 2 (Red)

Page

Exposure compensation	1/3- and 1/2-stop increments, ± 3 stops	200
ISO speed settings	ISO speed* / Range for movies	148 332
Auto Lighting Optimizer	Disable / Low / Standard / High Disabled in M or B modes	169
White balance	AWB (Ambience priority) / AWB w (White priority) / ☀️ / 🏠 / ☁️ / ☀️ / 🌅 / 🌧️ / 🌧️ / 🌧️ / 🌧️ (Approx. 2500 - 10000)	162
Custom White Balance	Manual setting of white balance	164
White balance correction	B/A/M/G bias, 9 levels each	167

* Settable only for manual exposures.

📷: Shooting 3 (Red)

Picture Style	Auto / Standard / Portrait / Landscape / Fine Detail / Neutral / Faithful / Monochrome / User Def. 1-3	154
High ISO speed noise reduction	Disable / Low / Standard / High	170
Highlight tone priority	Disable / Enable	174
Dust Delete Data	Obtain data to be used by Digital Photo Professional (EOS software) to delete dust spots	405

 **Shooting 4**^{*1} (Red)

Page









Movie Servo AF	Enable / Disable	326
AF method	☺+Tracking / FlexiZone - Multi / FlexiZone - Single	327
Movie recording quality	MOV / MP4	306
	Movie recording size (MOV format): <ul style="list-style-type: none"> • 1920x1080 • NTSC: 29.97p / 23.98p PAL: 25.00p • ALL-I (For editing) Movie recording size (MP4 format): <ul style="list-style-type: none"> • 1920x1080 / 1280x720 • NTSC: 59.94p / 29.97p / 23.98p PAL: 50.00p / 25.00p • IPB (Standard) / IPB (Light) 	307
Digital zoom	Disable / Approx. 3-10x zoom	311
Sound recording ^{*2}	Sound recording: Auto / Manual / Disable	312
	Recording level	
	Wind filter: Auto / Disable	
	Attenuator: Disable / Enable	
Movie Servo AF speed	When active: Always on / During shooting	329
	AF speed: Slow (-7/-6/-5/-4/-3/-2/-1) / Standard / Fast (+1/+2)	
Movie Servo AF tracking sensitivity	Locked on (-3/-2/-1) / 0 / Responsive (+1/+2/+3)	330

*1: In Basic Zone modes, these menu options are displayed under the  2 tab.

*2: In Basic Zone modes, [Sound recording] will be set to [On/Off].

 **Shooting 5^{*1} (Red)**

Page

Metering timer	4 sec. / 8 sec. / 16 sec. / 30 sec. / 1 min. / 10 min. / 30 min.	331
Grid display	Off / 3x3  / 6x4  / 3x3+diag 	331
 button function	 AF / - /  AF /  AF /  AF	331
Video snapshot	Video snapshot: Enable / Disable	333
	Album settings: Create a new album / Add to existing album	
	Show confirm message: Enable/Disable	
Time-lapse movie	Disable / Enable (Interval / No. of shots / Time required / Playback time/ Card- time left)	319
Remote control shooting	Disable / Enable	332

*1: In Basic Zone modes, these menu options are displayed under the  **3** tab.

Troubleshooting Guide

If a problem occurs with the camera, first consult this Troubleshooting Guide. If this Troubleshooting Guide does not resolve the problem, contact your dealer or nearest Canon Service Center.

Power-Related Problems

The battery does not recharge.

- If the battery's remaining capacity is 94% or higher, the battery will not be recharged (p.452).
- Do not use any battery other than a genuine Battery Pack LP-E6N/LP-E6.

The charger's lamp blinks at high speed.

- If (1) the battery charger or battery has a problem or (2) communication with the battery failed (with a non-Canon battery), the protection circuit will stop charging, and the charge lamp will blink in orange at a high speed. In the case of (1), unplug the charger's power plug from the power outlet. Detach and reattach the battery to the charger. Wait a few minutes, then reconnect the power plug to the power outlet. If the problem persists, contact your dealer or nearest Canon Service Center.

The charger's lamp does not blink.

- If the internal temperature of the battery attached to the charger is high, the charger will not charge the battery for safety reasons (lamp off). If the battery temperature becomes high for any reason during charging, the charging will stop automatically (lamp blinks). When the battery temperature goes down, the charging will resume automatically.

The camera does not operate even when the power switch is set to <ON>.

- Make sure the battery is installed properly in the camera (p.36).
- Make sure the battery compartment cover is closed (p.36).
- Make sure the card slot cover is closed (p.37).
- Recharge the battery (p.34).

The access lamp still lights or blinks even when the power switch is <OFF>.

- If the power is turned off while an image is being recorded to the card, the access lamp will remain on/continue to blink for a few seconds. When the image recording is completed, the power will turn off automatically.

[Does this battery/do these batteries display the Canon logo?] is displayed.

- Do not use any battery other than a genuine Battery Pack LP-E6N/LP-E6.
- Remove and install the battery again (p.36).
- If the electrical contacts are dirty, use a soft cloth to clean them.

The battery becomes exhausted quickly.

- Use a fully-charged battery (p.34).
- The battery performance may have degraded. See [**⚙3: Battery info.**] to check the battery's recharge performance level (p.452). If the battery performance is poor, replace the battery with a new one.
- The number of possible shots will decrease with any of the following operations:
 - Pressing the shutter button halfway for a prolonged period.
 - Activating the AF frequently without taking a picture.
 - Using the lens's Image Stabilizer.
 - Using the LCD monitor frequently.
 - Continuing Live View shooting or movie shooting for a prolonged period.
 - The Eye-Fi card's communication function is enabled.

The camera turns off by itself.

- Auto power off is in effect. If you do not want auto power off to take effect, set [**⚙2: Auto power off**] to [**Disable**] (p.66).
- Even if [**⚙2: Auto power off**] is set to [**Disable**], the LCD monitor will still turn off after the camera is left idle for approx. 30 min. (The camera's power does not turn off.)

Shooting-Related Problems

The lens cannot be attached.

- The camera cannot be used with EF-M lenses (p.47).

The viewfinder is dark.

- Install a recharged battery in the camera (p.34).

No images can be shot or recorded.

- Make sure if the card is properly inserted (p.37).
- Slide the card's write-protect switch to the write/erase position (p.37).
- If the card is full, replace the card or delete unnecessary images to make space (p.37, 378).
- If you try to focus in the One-Shot AF mode and the focus indicator <●> in the viewfinder blinks, a picture cannot be taken. Press the shutter button halfway again to refocus automatically, or focus manually (p.50, 137).

The card cannot be used.

- If a card error message is displayed, see page 39 or 496.

I cannot lock the focus and recompose the shot.

- Set the AF operation to One-Shot AF. Focus lock is not possible in the AI Servo AF mode or when servo takes effect in AI Focus AF mode (p.118).

The image is out of focus or blurred.

- Set the lens's focus mode switch to <AF> (p.47).
- Press the shutter button gently to prevent camera shake (p.49-50).
- If the lens has an Image Stabilizer, set the IS switch to <ON>.
- In low light, the shutter speed may become slow. Use a faster shutter speed (p.192), set a higher ISO speed (p.148), use flash (p.228, 233), or use a tripod.

There are fewer AF points.

- Depending on the attached lens, the number of usable AF points and patterns varies. The lenses are categorized into eight groups from A to H. Check which group your lens belongs to. Using a lens in Groups E to H will have fewer usable AF points (p.130-131).

The AF point is blinking.

- Regarding lighting up or blinking of the AF points when you press the <AF-ON> button, see page 123.

The AF points do not light up in red.

- The AF points light up in red only when focus is achieved in low-light conditions.
- In Creative Zone modes, you can set whether to have the AF points light up in red when focus is achieved (p.424).

The continuous shooting speed is slow.

- The continuous shooting speed may become slower depending on the shutter speed, aperture, subject conditions, brightness, lens, flash use, temperature, battery type, remaining battery level, shooting function settings, etc. For details, see page 139.



With FlexiZone - Multi, it takes longer to focus.

- Depending on the shooting conditions, it may take longer to focus on the subject. Use FlexiZone - Single or focus manually.

The maximum burst during continuous shooting is lower.

- If you shoot something that has fine detail such as a field of grass, the file size will be larger, and the actual maximum burst may be lower than the number listed on page 143.

ISO 100 cannot be set. ISO speed expansion cannot be selected.

- When [3: Highlight tone priority] is set to [Disable], ISO100/125/160 can be set (p.174).
- If [3: Highlight tone priority] is set to [Enable], the settable ISO speed range will be ISO 200 - ISO 16000 (or up to ISO 12800 for movie shooting). Even if you expand the settable ISO speed range in [Range for stills] or [Range for movies], you cannot set expanded ISO speeds (H).

Even though I set a decreased exposure compensation, the image comes out bright.

- Set [2: Auto Lighting Optimizer] to [Disable]. When [Low], [Standard], or [High] is set, even if you set a decreased exposure compensation or flash exposure compensation, the image may come out bright (p.169).

The multiple-exposure image is shot in RAW quality.

- When the image-recording quality is set to **M RAW** or **S RAW**, the multiple-exposure image will be recorded in **RAW** quality (p.218).

When I use the <Av> mode with flash, the shutter speed becomes slow.

- If you shoot at night when the background is dark, the shutter speed automatically becomes slow (slow-sync shooting) so that both the subject and background are properly exposed. To prevent a slow shutter speed, under [1: Flash control], set [Flash sync. speed in Av mode] to [1/250-1/60sec. auto] or [1/250 sec. (fixed)] (p.236).

The built-in flash rises by itself.

- In shooting modes (< > < > <SCN: > <: >) whose default setting is < > (Auto built-in flash firing), the built-in flash will be raised automatically when necessary.
- In the <SCN: > and <: > modes, when you press the shutter button halfway under low-light conditions, the built-in flash may be raised automatically and emit the AF-assist beam.

The built-in flash does not fire.

- If you use the built-in flash too often in too short a period of time, the flash may stop firing for a while to protect the light-emitting unit.

The external flash does not fire.

- If you use a non-Canon flash unit with Live View shooting, set [**📷6: Silent LV shoot.**] to [**Disable**] (p.272).

The external flash always fires at full output.

- If you use a flash unit other than an EX-series Speedlite, the flash will always be fired at full output (p.234).
- When the external Speedlite's [**Flash metering mode**] Custom Function is set to [**TTL**] (autoflash), the flash will always be fired at full output (p.243).

Flash exposure compensation cannot be set for the external Speedlite.

- If flash exposure compensation is set with the external Speedlite, flash exposure compensation cannot be set with the camera. When the external Speedlite's flash exposure compensation is canceled (set to 0), flash exposure compensation can be set with the camera.

High-speed sync cannot be set in the <Av> mode.

- Under [**📷1: Flash control**], set [**Flash sync. speed in Av mode**] to [**Auto**] (p.236).

The camera makes a noise when it is shaken.

- The built-in flash's pop-up mechanism moves slightly. This is normal and not a malfunction.

The shutter makes two shutter release sounds during Live View shooting.

- If you use flash, the shutter will make two shutter release sounds each time you shoot (p.257).

During Live View shooting, a white or red icon is displayed.

- It indicates that the camera's internal temperature is high. If the white icon is displayed, the still photo's image quality may deteriorate. If the red icon is displayed, it indicates that the Live View shooting will soon stop automatically (p.290).

During movie shooting, a red icon is displayed.

- It indicates that the camera's internal temperature is high. If the red icon is displayed, it indicates that the movie shooting will soon stop automatically (p.343).

Movie shooting stops by itself.

- If the card's writing speed is slow, movie shooting may stop automatically. For cards that can record movies, see page 5. To find out the card's writing speed, refer to the card manufacturer's Web site.
- If the movie shooting time reaches 29 min. 59 sec., the movie shooting will stop automatically.

The ISO speed cannot be set for movie shooting.

- In shooting modes other than <M>, the ISO speed is set automatically. In the <M> mode, you can freely set the ISO speed (p.299).

The manually set ISO speed changes when switching to movie shooting.

- ISO speed will be set according to the setting for [Range for stills] during viewfinder shooting and Live View shooting, or that for [Range for movies] during movie shooting with manual exposure.

The exposure changes during movie shooting.

- If you change the shutter speed or aperture during movie shooting, the changes in the exposure may be recorded.
- Zooming the lens during movie shooting may cause changes in the exposure regardless of whether the lens's maximum aperture changes or not. The changes in the exposure may be recorded as a result.

The subject looks distorted during movie shooting.

- If you move the camera to the left or right quickly or shoot a moving subject, the image may look distorted. The problem may be more noticeable in time-lapse movie shooting.

The image flickers or horizontal stripes appear during movie shooting.

- Flickering, horizontal stripes (noise), or irregular exposures can be caused by fluorescent lighting, LED lighting, or other light sources during movie shooting. Also, changes in the exposure (brightness) or color tone may be recorded. In the <M> mode, a slow shutter speed may reduce the problem. The problem may be more noticeable in time-lapse movie shooting.

Wireless Functions

Wireless functions cannot be set.

- If the camera is connected to a computer, GPS receiver, or other device with an interface cable, wireless functions cannot be set ([**F1: Wireless communication settings**] will be grayed out). Disconnect the interface cable before changing any settings.
- Refer to the Wireless Function Instruction Manual.

Operation Problems

I cannot change the setting with the <>, <>, <>, or touch screen.

- Set the <**LOCK**> switch downward (lock release, p.54).
- Check the [**F4: Multi function lock**] setting (p.54).

A camera button or dial does not work as expected.

- Check the [**C.Fn III -4: Custom Controls**] setting (p.433).

During touch screen operations, the beeper suddenly sounds softer.

- Check if your finger is blocking the speaker (p.26).

Touch screen operation is not possible.

- Check if [**F3: Touch control**] is set to [**Standard**] or [**Sensitive**] (p.63).

Display Problems

The menu screen shows fewer tabs and options.

- In Basic Zone modes, certain tabs and menu options are not displayed. Set the shooting mode to a Creative Zone mode (p.58).
- Under the [★] tab, [Menu display] is set to [Display only My Menu tab] (p.444).

The file name's first character is an underscore (“_”).

- Set the color space to sRGB. If Adobe RGB is set, the first character will be an underscore (p.181).

The file name starts with “MVI_”.

- It is a movie file (p.185).

The file numbering does not start from 0001.

- If the card already contains recorded images, the image number may not start from 0001 (p.184).

The shooting date and time displayed is incorrect.

- Make sure the correct date and time are set (p.43).
- Check the time zone and daylight saving time (p.43).

The date and time are not in the image.

- The shooting date and time do not appear in the image. The date and time are instead recorded in the image data as shooting information. When printing, you can imprint the date and time in the picture, using the date and time recorded in the shooting information (p.380).

[###] is displayed.

- If the number of images recorded on the card exceeds the number the camera can display, [###] will be displayed (p.360).

In the viewfinder, the AF point display speed is slow.

- In low temperatures, the display speed of the AF points may become slower due to the AF point display device's characteristics. The display speed will return to normal at room temperature.

The LCD monitor does not display a clear image.

- If the LCD monitor is dirty, use a soft cloth to clean it.
- In low or high temperatures, the LCD monitor display may seem slow or may look black. It will return to normal at room temperature.

[Eye-Fi settings] does not appear.

- **[Eye-Fi settings]** will appear only when an Eye-Fi card is inserted in the camera. If the Eye-Fi card has a write-protect switch set to the <LOCK> position, you will not be able to check the card's connection status or disable Eye-Fi transmission (p.457).

Playback Problems

Part of the image blinks in black.

- [ 3: Highlight alert] is set to [Enable] (p.351).

A red box is displayed on the image.

- [ 3: AF point disp.] is set to [Enable] (p.352).

The image cannot be erased.

- If the image is protected, it cannot be erased (p.376).

The movie cannot be played back.

- Movies edited with a computer cannot be played back with the camera.

Operation sound and mechanical sound can be heard during movie playback.

- If you operate the camera's dials or lens during movie shooting, the operation sound will also be recorded. Using a commercially-available external microphone is recommended (p.313).

The movie appears to freeze momentarily.

- If there is a drastic change in the exposure level during autoexposure movie shooting, the recording will stop momentarily until the brightness stabilizes. In such a case, shoot in <M> mode (p.298).

No picture on the TV set.

- Make sure the [**4**: Video system] is correctly set to [For NTSC] or [For PAL] (depending on the video system of your TV set).
- Make sure the HDMI cable's plug is inserted all the way in (p.373).

There are multiple movie files for a single movie shoot.

- If the movie file size reaches 4 GB, another movie file will be created automatically (p.309).

My card reader does not recognize the card.

- Depending on the card reader and computer OS used, SDXC cards may not be correctly recognized. In such a case, connect your camera to the computer with the interface cable, then transfer the images to the computer using EOS Utility (EOS software, p.512).

I cannot process the RAW image.

- **M RAW** and **S RAW** images cannot be processed with the camera. Use Digital Photo Professional (EOS software) to process the image (p.512).

I cannot resize or crop the image.

- JPEG **S3**, **RAW**, **M RAW**, and **S RAW** images cannot be resized or cropped with the camera (p.395).

Sensor Cleaning Problems

The shutter makes a noise during sensor cleaning.

- If you selected [**Clean now** ], the shutter will make a noise, but no picture is taken (p.404).

Automatic sensor cleaning does not work.

- If you repeatedly turn the power switch <ON> / <OFF> at a short interval, the < > icon may not be displayed (p.41).

Computer Connection Problems

Communication between the connected camera and computer does not work.

- When using EOS Utility (EOS software), set [ **5: Time-lapse movie**] to [**Disable**] (p.319).

I cannot download images to a computer.

- Install the EOS software on the computer (p.513).
- During a wireless connection, the camera cannot be connected to a computer via an interface cable.

Error Codes

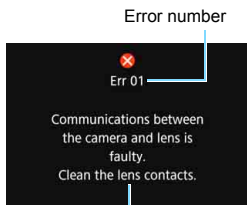

Error number

If there is a problem with the camera, an error message will appear. Follow the on-screen instructions.

Cause and countermeasures

Number	Error Message and Solution
01	<p>Communications between the camera and lens is faulty. Clean the lens contacts.</p> <p>→ Clean the electrical contacts on the camera and lens, use a Canon lens, or remove and install the battery again (p.25, 26, 36).</p>
02	<p>Card cannot be accessed. Reinsert/change card or format card with camera.</p> <p>→ Remove and insert the card again, replace the card, or format the card (p.37, 64).</p>
04	<p>Cannot save images because card is full. Replace card.</p> <p>→ Replace the card, erase unnecessary images, or format the card (p.37, 64, 378).</p>
05	<p>The built-in flash could not be raised. Turn the camera off and on again.</p> <p>→ Operate the power switch (p.41).</p>
06	<p>Sensor cleaning could not be performed. Turn the camera off and on again.</p> <p>→ Operate the power switch (p.41).</p>
10, 20 30, 40 50, 60 70, 80 99	<p>An error prevented shooting. Turn the camera off and on again or re-install the battery.</p> <p>→ Operate the power switch, remove and install the battery again, or use a Canon lens (p.36, 41).</p>

* If the error still persists, write down the error number and contact your nearest Canon Service Center.

Specifications

• Type

Type:	Digital, single-lens reflex, AF/AE camera with built-in flash
Recording media:	SD/SDHC*/SDXC* memory cards * UHS-I cards supported
Image sensor size:	Approx. 22.3 x 14.9 mm
Compatible lenses:	Canon EF lenses (including EF-S lenses) * Excluding EF-M lenses (35mm-equivalent angle of view is that of a lens with approx. 1.6x the focal length indicated.)
Lens mount:	Canon EF mount

• Image Sensor

Type:	CMOS sensor
Effective pixels:	Approx. 24.2 megapixels * Rounded off to the nearest 10,000th.
Aspect ratio:	3:2
Dust delete feature:	Auto, Manual, Dust Delete Data appending

• Recording System

Recording format:	Design rule for Camera File System (DCF) 2.0
Image type:	JPEG, RAW (14-bit Canon original), RAW+JPEG simultaneous recording possible
Pixels recorded:	L (Large) : 24.0 megapixels (6000 x 4000) M (Medium) : Approx. 10.6 megapixels (3984 x 2656) S1 (Small 1): Approx. 5.9 megapixels (2976 x 1984) S2 (Small 2): Approx. 2.5 megapixels (1920 x 1280) S3 (Small 3): Approx. 350,000 pixels (720 x 480) RAW : 24.0 megapixels (6000 x 4000) M-RAW : 13.5 megapixels (4500 x 3000) S-RAW : 6.0 megapixels (3000 x 2000)
Aspect ratio:	3:2, 4:3, 16:9, 1:1
Create/select a folder:	Possible
File numbering:	Continuous, Auto reset, Manual reset

• Image Processing During Shooting

Picture Style:	Auto, Standard, Portrait, Landscape, Fine Detail, Neutral, Faithful, Monochrome, User Defined 1 - 3
----------------	---

White balance:	Auto (Ambience priority), Auto (White priority), Preset (Daylight, Shade, Cloudy, Tungsten light, White fluorescent light, Flash), Custom, Color temperature setting (approx. 2500-10000 K), White balance correction, and White balance bracketing provided * Flash color temperature information transmission enabled
Noise reduction:	Applicable to long exposures and high ISO speed shots
Automatic image brightness correction:	Auto Lighting Optimizer provided
Highlight tone priority:	Provided
Lens aberration correction:	Peripheral illumination correction, Chromatic aberration correction, Distortion correction

• Viewfinder

Type:	Eye-level pentaprism
Coverage (by aspect ratio):	3:2 (vertical: approx. 100%, horizontal: approx. 100%), 4:3 (vertical: approx. 100%, horizontal: approx. 97%), 16:9 (vertical: approx. 97%, horizontal: approx. 100%), 1:1 (vertical: approx. 100%, horizontal: approx. 96%) * With eyepoint at approx. 22mm.
Magnification:	Approx. 0.95x (-1 m ⁻¹ with 50mm lens at infinity)
Eye point:	Approx. 22mm (from eyepiece lens center at -1 m ⁻¹)
Diopric adjustment range:	Approx. -3.0 - +1.0 m ⁻¹ (dpt)
Focusing screen:	Fixed
Grid display:	Provided
Electronic level:	Provided
Mirror:	Quick-return type
Depth-of-field preview:	Provided

• Autofocus (for viewfinder shooting)

Type:	TTL secondary image-registration, phase-difference detection with the dedicated AF sensor
AF points:	45 (Cross-type AF point: Max. 45 points) * Number of available AF points, Dual cross-type AF points, and cross-type AF points vary depending on the lens used and aspect ratio settings. * Dual cross-type focusing at f/2.8 with center AF point. (AF group: When Group A lenses are used)
Focusing brightness range:	EV -3 - 18 (with the center AF point supporting f/2.8, One-Shot AF, at room temperature, ISO 100)

Focus operation:	One-Shot AF, AI Servo AF, AI Focus AF, Manual focusing (MF)
AF area selection mode:	Single-point AF (Manual selection), Zone AF (Manual selection of zone), Large Zone AF (manual selection of zone), 45-point automatic selection AF
AF point automatic selection conditions:	AF points can be selected automatically using information on colors equivalent to skin tones.
AI Servo AF characteristics:	Tracking sensitivity, Acceleration/deceleration tracking, AF point auto switching
AF fine adjustment:	AF Microadjustment (All lenses by same amount or Adjust by lens)
AF-assist beam:	Small series of flashes fired by built-in flash

• Exposure Control

Metering mode:	63-zone TTL open-aperture metering using 7560-pixel RGB plus IR metering sensor <ul style="list-style-type: none"> • Evaluative metering (linked to all AF points) • Partial metering (approx. 6.0% of viewfinder at center) • Spot metering (approx. 3.8% of viewfinder at center) • Center-weighted average metering
Metering brightness range:	EV 1 - 20 (at room temperature, ISO 100)
Shooting mode:	Basic Zone modes: Scene Intelligent Auto, Flash Off, Creative Auto, Special scene modes (Food, Kids, Candlelight, Night Portrait, Handheld Night Scene, HDR Backlight Control, Portrait, Landscape, Close-up, Sports), Creative filters (Grainy B/W, Soft focus, Fish-eye effect, Toy camera effect, Miniature effect, Water painting effect, HDR art standard, HDR art vivid, HDR art bold, HDR art embossed) Creative Zone modes: Program AE, Shutter-priority AE, Aperture-priority AE, Manual exposure, Bulb exposure, Custom shooting mode
ISO speed (Recommended exposure index):	Basic Zone modes*: ISO 100 - ISO 6400 set automatically * Handheld Night Scene: ISO 100 - ISO 12800 set automatically, Landscape: ISO 100 - ISO 1600 set automatically P, Tv, Av, M, B: ISO Auto, ISO 100 - ISO 16000 set manually (1/3- and whole-stop increments), and ISO expansion to H (equivalent to ISO 25600)

ISO speed settings:	Range for stills, Auto range, and Minimum shutter speed for auto settable
Exposure compensation:	Manual: ± 5 stops in 1/3- or 1/2-stop increments AEB: ± 3 stops in 1/3- or 1/2-stop increments (can be combined with manual exposure compensation)
AE lock:	Auto: Applied in One-Shot AF with evaluative metering when focus is achieved Manual: With AE lock button
Anti-flicker:	Possible
Interval timer:	Shooting interval and shot count settable
Bulb timer:	Bulb exposure time settable

• HDR Shooting

Dynamic range adjustment:	Auto, ± 1 , ± 2 , ± 3
Effects:	Natural, Art standard, Art vivid, Art bold, Art embossed
Auto image alignment:	Provided

• Multiple Exposures

Number of multiple exposures:	2 to 9 exposures
Multiple-exposure control:	Additive, Average

• Shutter

Type:	Electronically-controlled, focal-plane shutter
Shutter speed:	1/8000 sec. to 30 sec. (total shutter speed range; available range varies by shooting mode), Bulb, X-sync at 1/250 sec.

• Drive System

Drive mode:	Single shooting, High-speed continuous shooting, Low-speed continuous shooting, Silent single shooting, Silent continuous shooting, 10-sec. self-timer/remote control, 2-sec. self-timer/remote control
Continuous shooting speed:	High-speed continuous shooting: Max. approx. 7.0 shots/sec.* * Max. approx. 5.0 shots/sec. during Live View shooting or when [Servo AF] is set. Low-speed continuous shooting: Max. approx. 3.0 shots/sec. Silent continuous shooting: Max. approx. 3.0 shots/sec.

Max. burst:	JPEG Large/Fine: Approx. 77 shots (approx. 110 shots) RAW: Approx. 20 shots (approx. 25 shots) RAW+JPEG Large/Fine: Approx. 20 shots (approx. 22 shots) * Figures are based on Canon's testing standards (3:2 aspect ratio, ISO 100 and Standard Picture Style) using an 8 GB card. * Figures in parentheses apply to an UHS-I compatible 16 GB card based on Canon's testing standards.
-------------	--

• Flash

Built-in flash:	Retractable, auto pop-up flash Guide No.: Approx. 12/39.4 (ISO 100, in meters/feet) Flash coverage: Approx. 17mm lens angle of view Recharge time: Approx. 3 sec.
External Speedlite:	Compatible with EX-series Speedlites
Flash metering:	E-TTL II autoflash
Flash exposure compensation:	±3 stops in 1/3- or 1/2-stop increments
FE lock:	Provided
PC terminal:	None
Flash control:	Built-in flash function settings, external Speedlite function settings, external Speedlite Custom Function settings Wireless flash control via optical transmission possible

• Live View Shooting

Focus method:	Dual Pixel CMOS AF system
AF method:	Face+Tracking, FlexiZone-Multi, FlexiZone-Single Manual focus (approx. 5x / 10x magnification possible)
AF operation:	One-Shot AF, Servo AF
Focusing brightness range:	EV 0 - 18 (at room temperature, ISO 100)
Metering mode:	Evaluative metering (315 zones), Partial metering (approx. 6.1% of Live View screen), Spot metering (approx. 2.6% of Live View screen), Center-weighted average metering
Metering brightness range:	EV 0 - 20 (at room temperature, ISO 100)
Exposure compensation:	±3 stops in 1/3-stop or 1/2-stop increments

Specifications

Creative filters:	Provided
Silent LV shooting:	Provided (Mode 1 and 2)
Touch shutter:	Provided
Grid display:	Three types

• Movie Shooting

Recording format:	MOV/MP4
Movie:	MPEG-4 AVC / H.264 Variable (average) bit rate
Audio:	MOV: Linear PCM, MP4: AAC
Recording size and frame rate:	[MOV] Full HD (1920x1080): 29.97p/25.00p/23.98p [MP4] Full HD (1920x1080): 59.94p/50.00p/29.97p/25.00p/ 23.98p HD (1280x720) : 59.94p/50.00p/29.97p/25.00p
Compression method:	[MOV] : ALL-I (For editing/I-only) [MP4] : IPB (Standard), IPB (Light)
Bit rate:	[MOV] Full HD (29.97p/25.00p/23.98p)/ALL-I : Approx. 90 Mbps [MP4] Full HD (59.94p/50.00p)/IPB (Standard) : Approx. 60 Mbps Full HD (29.97p/25.00p/23.98p)/IPB (Standard) : Approx. 30 Mbps Full HD (29.97p/25.00p)/IPB (Light) : Approx. 12 Mbps HD (59.94p/50.00p)/IPB (Standard) : Approx. 26 Mbps HD (29.97p/25.00p)/IPB (Light) : Approx. 4 Mbps HDR Movie Shooting : Approx. 30 Mbps
Focus method:	Dual Pixel CMOS AF system
AF method:	Face+Tracking, FlexiZone-Multi, FlexiZone-Single Manual focus (approx. 5x / 10x magnification possible)
Movie Servo AF:	Provided * Movie Servo AF customizable
Digital zoom:	Approx. 3x - 10x
Focusing brightness range:	EV 0 - 18 (at room temperature, ISO 100)
Metering mode:	Center-weighted average or Evaluative metering

Metering brightness range:	EV 0 - 20 (at room temperature, ISO 100)
Exposure control:	Autoexposure shooting (Program AE for movie shooting) and manual exposure
Exposure compensation:	±3 stops in 1/3- or 1/2-stop increments
ISO speed (Recommended exposure index):	For autoexposure shooting: ISO 100 - ISO 12800 set automatically. In Creative Zone modes, the upper limit is expandable to H (equivalent to ISO 25600). For manual exposure shooting: ISO Auto (ISO 100 - ISO 12800 set automatically), ISO 100 - ISO 12800 set manually (1/3- and whole-stop increments), expandable to H (equivalent to ISO 25600)
ISO speed settings:	Range for movie shooting settable
HDR Movie Shooting:	Possible
Creative filters for movies:	Memory, Dream, Old Movies, Dramatic B&W, Miniature effect movie
Video snapshots:	Settable to 2 sec./4 sec./8 sec.
Sound recording:	Built-in stereo microphones, external stereo microphone terminal provided Sound-recording level adjustable, wind filter provided, attenuator provided
Headphones:	Headphone terminal provided, sound volume adjustable
Grid display:	Three types
Time-lapse movie:	Shooting interval and number of shots settable Required shooting time period, playback length, and remaining card capacity viewable
Still photo shooting:	Not possible during movie shooting

• LCD Monitor

Type:	TFT color, liquid-crystal monitor
Monitor size and dots:	Wide 7.7 cm (3.0 in) (3:2) with approx. 1.04 million dots
Brightness adjustment:	Manual (7 levels)
Electronic level:	Provided
Interface languages:	25
Touch screen technology:	Capacitive sensing
Feature guide / Help:	Displayable

• Playback

Image display format:	Single-image display (without shooting information), Single-image display (with basic information), Single-image display (Shooting information displayed: Detailed information, Lens/histogram, White balance, Picture Style 1, Picture Style 2, Color space/noise reduction, Lens aberration correction), Index display (4/9/36/100 images)
Highlight alert:	Overexposed highlights blink
AF point display:	Provided (may not be displayed depending on shooting conditions)
Grid display:	Three types
Zoom magnification:	Approx. 1.5x - 10x
Image browsing methods:	Single image, jump by 10 or 100 images, by shooting date, by folder, by movies, by stills, by rating
Image rotation:	Possible
Image protection:	Possible
Rating:	Provided
Movie playback:	Enabled (LCD monitor, HDMI), built-in speaker
Slide show:	All images, by date, by folder, by movies, by stills, by rating
Background music:	Selectable for slide shows and movie playback

• Post-Processing of Images

In-camera RAW image processing:	Brightness adjustment, White balance, Picture Style, Auto Lighting Optimizer, High ISO speed noise reduction, JPEG image-recording quality, Color space, Peripheral illumination correction, Distortion correction, Chromatic aberration correction
Resize:	Provided
Creative filters:	Grainy B/W, Soft focus, Fish-eye effect, Art bold effect, Water painting effect, Toy camera effect, Miniature effect

• Print Ordering

DPOF:	Version 1.1 compliant
-------	-----------------------

• Customization Features

Custom Functions:	26
My Menu:	Up to 5 screens can be registered
Custom shooting mode:	Register under Mode Dial's C1 or C2
Copyright information:	Entry and appending possible

• Interface

DIGITAL terminal:	Computer communication (Hi-Speed USB equivalent), GPS Receiver GP-E2, Connect Station CS100 connection
HDMI mini OUT terminal:	Type C (Auto switching of resolution), CEC-compatible
External microphone IN terminal:	3.5 mm diameter stereo mini-jack
Remote control terminal:	For Remote Switch RS-60E3
Wireless remote control:	Compatible with Remote Controller RC-6
Eye-Fi card:	Compatible

• Power

Battery:	Battery Pack LP-E6N/LP-E6, quantity 1 * AC power usable with household power outlet accessories. * With Battery Grip BG-E14 attached, AA/R6 batteries can be used.
Battery information:	Remaining capacity, Shutter count, Recharge performance, and Battery registration possible
Number of possible shots: (Based on CIPA testing standards, with 50% flash use)	With viewfinder shooting: Approx. 960 shots at room temperature (23°C/73°F), approx. 860 shots at low temperatures (0°C/32°F) With Live View shooting: Approx. 300 shots at room temperature (23°C/73°F), approx. 270 shots at low temperatures (0°C/32°F)
Movie shooting time:	Total approx. 1 hr. 50 min. at room temperature (23°C/73°F) Total approx. 1 hr. 40 min. at low temperatures (0°C/32°F) * With a fully-charged Battery Pack LP-E6N.

• Dimensions and Weight

Dimensions (W x H x D):	Approx. 139.0 x 105.2 x 78.5 mm / 5.47 x 4.14 x 3.09 in.
Weight:	Approx. 730 g / 25.75 oz. (Based on CIPA Guidelines) Approx. 650 g / 22.93 oz. (Body only)

• Operation Environment

Working temperature range:	0°C - 40°C / 32°F - 104°F
Working humidity:	85% or less

• Battery Pack LP-E6N

Type:	Rechargeable lithium-ion battery
Rated voltage:	7.2 V DC
Battery capacity:	1865 mAh
Working temperature range:	0°C - 40°C / 32°F - 104°F
Working humidity:	85% or less
Dimensions (W x H x D):	Approx. 38.4 x 21.0 x 56.8 mm / 1.5 x 0.8 x 2.2 in.
Weight:	Approx. 80 g / 2.8 oz. (excluding protective cover)

• Battery Charger LC-E6

Compatible battery:	Battery Pack LP-E6N/LP-E6
Recharging time:	Approx. 2 hr. 30 min.
Rated input:	100 - 240 V AC (50/60 Hz)
Rated output:	8.4 V DC / 1.2 A
Working temperature range:	5°C - 40°C / 41°F - 104°F
Working humidity:	85% or less
Dimensions (W x H x D):	Approx. 69.0 x 33.0 x 93.0 mm / 2.7 x 1.3 x 3.7 in.
Weight:	Approx. 115 g / 4.1 oz.

• Battery Charger LC-E6E

Compatible battery:	Battery Pack LP-E6N/LP-E6
Power cord length:	Approx. 1 m / 3.3 ft.
Recharging time:	Approx. 2 hr. 30 min.
Rated input:	100 - 240 V AC (50/60 Hz)
Rated output:	8.4 V DC/1.2 A
Working temperature range:	5°C - 40°C / 41°F - 104°F
Working humidity:	85% or less
Dimensions (W x H x D):	Approx. 69.0 x 33.0 x 93.0 mm / 2.7 x 1.3 x 3.7 in.
Weight:	Approx. 110 g / 3.9 oz. (excluding power cord)

- All the data above is based on Canon's testing standards and CIPA (Camera & Imaging Products Association) testing standards and guidelines.
- Dimensions and weight listed above are based on CIPA Guidelines (except weight for camera body only).
- Product specifications and the exterior are subject to change without notice.
- If a problem occurs with a non-Canon lens attached to the camera, consult the respective lens manufacturer.

Trademarks

- Adobe is a trademark of Adobe Systems Incorporated.
- Microsoft and Windows are trademarks or registered trademarks of Microsoft Corporation in the United States and/or other countries.
- Macintosh and Mac OS are trademarks of Apple Inc., registered in the U.S. and other countries.
- SDXC logo is a trademark of SD-3C, LLC.
- HDMI, HDMI logo, and High-Definition Multimedia Interface are trademarks or registered trademarks of HDMI Licensing LLC.
- All other trademarks are the property of their respective owners.

About MPEG-4 Licensing

“This product is licensed under AT&T patents for the MPEG-4 standard and may be used for encoding MPEG-4 compliant video and/or decoding MPEG-4 compliant video that was encoded only (1) for a personal and non-commercial purpose or (2) by a video provider licensed under the AT&T patents to provide MPEG-4 compliant video. No license is granted or implied for any other use for MPEG-4 standard.”

* Notice displayed in English as required.

Use of genuine Canon accessories is recommended

This product is designed to achieve excellent performance when used with genuine Canon accessories.

Canon shall not be liable for any damage to this product and/or accidents such as fire, etc., caused by the malfunction of non-genuine Canon accessories (e.g., a leakage and/or explosion of a battery pack). Please note that this warranty does not apply to repairs arising out of the malfunction of non-genuine Canon accessories, although you may request such repairs on a chargeable basis.

-  Battery Pack LP-E6N/LP-E6 is dedicated to Canon products only. Using it with an incompatible battery charger or product may result in malfunction or accidents for which Canon cannot be held liable.

Digital Camera Model DS126591 Systems

This device complies with Part 15 of the FCC Rules. Operation is subject to the following two conditions: (1) This device may not cause harmful interference, and (2) this device must accept any interference received, including interference that may cause undesired operation.

Note: This equipment has been tested and found to comply with the limits for class B digital devices, pursuant to Part 15 of the FCC Rules. These limits are designed to provide reasonable protection against harmful interference in a residential installation. This equipment generates, uses and can radiate radio frequency energy and, if not installed and used in accordance with the instructions, may cause harmful interference to radio communications. However, there is no guarantee that interference will not occur in a particular installation. If this equipment does cause harmful interference to radio or television reception, which can be determined by turning the equipment off and on, the user is encouraged to try to correct the interference by one or more of the following measures:

- Reorient or relocate the receiving antenna.
- Increase the separation between the equipment and receiver.
- Connect the equipment into an outlet on a circuit different from that to which the receiver is connected.
- Consult the dealer or an experienced radio/TV technician for help.

The cable with the ferrite core provided with the digital camera must be used with this equipment in order to comply with Class B limits in Subpart B of Part 15 of the FCC rules.

Do not make any changes or modifications to the equipment unless otherwise specified in the manual. If such changes or modifications should be made, you could be required to stop operation of the equipment.

Canon U.S.A. Inc.
One Canon Park, Melville, NY 11747, U.S.A.
Tel No. 1-800-OK-CANON (1-800-652-2666)

CAN ICES-3 (B) / NMB-3 (B)



USA and Canada only:

The Lithium ion/polymer battery that powers the product is recyclable. Please call 1-800-8-BATTERY for information on how to recycle this battery.

For CA, USA only

Included lithium battery contains Perchlorate Material – special handling may apply. See www.dtsc.ca.gov/hazardouswaste/perchlorate/ for details.

CAUTION

RISK OF EXPLOSION IF BATTERY IS REPLACED BY AN INCORRECT TYPE.
DISPOSE OF USED BATTERIES ACCORDING TO LOCAL REGULATION.

14

Software Start Guide / Downloading Images to a Computer

This chapter explains the following:

- Overview of the software for EOS DIGITAL cameras
- How to download and install the software on a computer
- How to download and view the Software Instruction Manuals (PDF files)
- How to download images from the camera to a computer

Software Start Guide

Software Overview

This section explains an overview of various software applications for EOS DIGITAL cameras. Internet connection is required to download and install the software. Download and installation are not possible in environments with no Internet connection.

EOS Utility

With the camera connected to a computer, EOS Utility enables you to transfer still photos and movies shot with the camera to the computer. You can also use this software to set various camera settings and shoot remotely from the computer connected to the camera. Also, you can copy background music tracks, such as EOS Sample Music*, to the card.

* You can use the background music as the soundtrack for a video snapshot album, movie, or slide show played back with your camera.

Digital Photo Professional

This software is recommended for users who shoot RAW images. You can view, edit, and print RAW and JPEG images.

* Some functions differ between the version to be installed on a 64-bit computer and that to be installed on a 32-bit computer.

Picture Style Editor

You can edit Picture Styles, and create and save original Picture Style files. This software is aimed at advanced users who are experienced in processing images.

Downloading and Installing the Software



- **Do not connect the camera to your computer before you install the software. Otherwise, the software will not be installed properly.**
- Even if a previous version of the software is installed on your computer, follow the procedure below to install the latest version. (The previous version will be overwritten.)

1 Download the software.

- Connect to the Internet from a computer and access the following Canon Web site.

www.canon.com/icpd

- Select your country or region of residence and download the software.
- Decompress it on the computer.

For Windows: Click the displayed installer file to start the installer.

For Macintosh: A dmg file will be created and displayed. Follow the steps below to start the installer.

(1) Double-click the dmg file.

- ▶ A drive icon and installer file will appear on the desktop. If the installer file does not appear, double-click the drive icon to display it.

(2) Double-click the installer file.

- ▶ The installer starts.

2 Click [Easy Installation] and follow the on-screen instructions to install.

- For Macintosh, click [Install].

Downloading and Viewing the Software Instruction Manuals (PDF Files)

Internet connection is required to download the Software Instruction Manuals (PDF files). Download is not possible in environments with no Internet connection.

1 Download the Software Instruction Manuals (PDF files).

- Connect to the Internet and access the following Canon Web site.
www.canon.com/icpd
- Select your country or region of residence and download the Instruction Manuals.

2 View the Software Instruction Manuals (PDF files).

- Double-click a downloaded Instruction Manual (PDF file) to open it.
- To view the Instruction Manuals (PDF files), Adobe Acrobat Reader DC or other Adobe PDF viewer (most recent version recommended) is required.
- Adobe Acrobat Reader DC can be downloaded free from the Internet.
- To learn how to use a PDF viewer, refer to its Help section.

Downloading Images to a Computer

You can use EOS software to download the images in the camera to a computer. There are two ways to do this.

Downloading by Connecting the Camera to the Computer

1 Install the software (p.513).

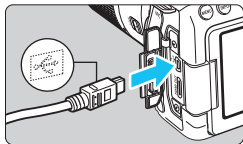

2 Use an interface cable to connect the camera to the computer.

- Connect the cable to the camera's digital terminal with the cable plug's $\leftarrow \leftrightarrow \rightarrow$ icon facing the front of the camera.
- Connect the plug to the computer's USB terminal.

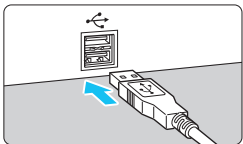

3 Use EOS Utility to download the images.

- Refer to the EOS Utility Instruction Manual.



During a wireless connection, the camera cannot be connected to a computer via an interface cable.

Downloading Images with a Card Reader

You can use a card reader to download images to a computer.

1 Install the software (p.513).

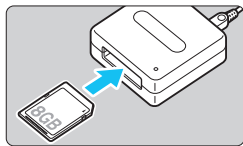

2 Insert the card into the card reader.

3 Use Digital Photo Professional to download the images.

- Refer to the Digital Photo Professional Instruction Manual.

 When downloading images from the camera to a computer with a card reader without using EOS software, copy the DCIM folder on the card to the computer.

Index

Numerics

10- or 2-sec. self-timer	140
1280x720 (movie)	307
1920x1080 (movie)	307
45-point AF auto selection	120

A

 (Scene Intelligent Auto)	78
Access lamp	38
Accessories	3
Adobe RGB	181
AE lock	203
AEB (Auto Exposure Bracketing) ...	201, 413
AF	

AF area selection mode	120, 121, 124
AF-assist beam	119, 419
AF groups	128
AF method	276, 327
AF Microadjustment	427
AF-ON (AF start) button	50
AF operation	116, 274
AF point	120
AF point selection	122, 436
AF points light up in red	119
AF sensor	127
Area AF frame	120, 125
Beep (Beeper)	66
Color tracking	126, 422
Cross-type focusing	127
Difficult subjects for AF	136, 284
Dual cross-type focusing	127
Manual focusing (MF)	137, 288
Out of focus	49, 284
Recomposing	81



AI FOCUS (AI Focus AF)	118
AI SERVO (AI Servo AF)	81, 118
Tracking sensitivity	416, 418
ALL-I (For editing/I-only)	308
Ambience-based shots	108

Angle of view	48
Anti-flicker shooting	179
Aperture-priority AE	194
Area AF frame	120, 125
Art bold effect	268, 401
Aspect ratio	146
Attenuator	312
Auto Lighting Optimizer	169
Auto playback	369
Auto power off	41, 66
Auto reset	185
Auto rotate vertical images	387
Autofocus → AF	
Automatic selection (AF point)	120, 125
Av (Aperture-priority AE)	194

B

B (Bulb)	204
Background blur	86
Background music	372
Basic Zone modes	30
Battery	34, 36, 42
Battery Grip	42, 468
Beep (Beeper)	66
Black-and-white images	108, 155, 159
Bracketing	168, 201
Built-in flash	228
Bulb exposures	204

C

 (Custom shooting modes)	445
 (Creative Auto)	84
Cable	373, 468
Camera	
Camera shake	49
Camera vibration blur	219
Clearing the camera settings	68

- Holding the camera 49
 - Settings display 450
 - Candlelight 91
 - Cards 5, 25, 37, 64
 - Card reminder 38
 - Formatting 64
 - Low-level formatting 65
 - Troubleshooting 39, 65
 - Write protection 37
 - Center-weighted average metering 199
 - Charger 32, 34
 - Chromatic aberration correction ... 176
 - Cleaning (image sensor) 403
 - Clearing the camera settings 68
 - Clipped highlights 351
 - Close-ups 97
 - Color saturation 158
 - Color space 181
 - Color temperature 162, 166
 - Color tone 89, 91, 158
 - Continuous file numbering 184
 - Continuous shooting 138
 - Contrast 158
 - Copyright information 186
 - Creative Auto 84
 - Creative filters 101, 266, 316, 399
 - Creative filters for movies 316
 - Dramatic B&W 318
 - Dream 317
 - Memory 317
 - Miniature effect movie 318
 - Old Movies 317
 - ☆ (Creative Zone) icon 8
 - Creative Zone modes 31
 - Cropping (images) 397
 - Cross-type focusing 127
 - Custom Controls 57, 433
 - Custom Functions 410
 - Custom shooting mode 445
 - Custom white balance (WB) 166
- ## D
- Date/time 43
 - Daylight saving time 44
 - DC Coupler 456
 - Default settings 68
 - Depth-of-field preview ... 195, 256, 261
 - Dials
 - Main Dial 51
 - Mode Dial 51
 - Quick Control Dial 52
 - Digital terminal 26, 515
 - Dioptric adjustment 49
 - Direct selection of AF point 436
 - DPOF (Digital Print Order Format) 380
 - Dragging 62
 - Drive mode 138
 - Dual cross-type focusing 127
 - Dust Delete Data 405
- ## E
- Electronic level 72
 - Erasing images 378
 - Error codes 496
 - Evaluative metering 198
 - exFAT 65
 - Exposure compensation 200
 - Exposure level increments 413
 - Exposure level indicator 29, 451
 - Exposure simulation 271
 - External Speedlite → Flash
 - Eyecup 220
 - Eye-Fi cards 457
 - Eyepiece cover 33

- F**
- FE lock 232, 233
 - Feature guide 75
 - FEB 242
 - File extension 185
 - File name 184
 - File size 143, 309, 349
 - Filter effects 156
 - Final image simulation 261, 301
 - Fine (image-recording quality) 143, 144
 - Firmware 476
 - First-curtain synchronization 241
 - Fish-eye effect 104, 268, 401
 - Flash (Speedlite)
 - Built-in flash 228
 - Custom Functions 243
 - Effective range 229
 - External flash 233
 - FE lock 232, 233
 - Flash control 235
 - Flash exposure compensation 230, 233, 242
 - Flash mode 240
 - Flash off 83, 107
 - Flash sync contacts 26
 - Flash sync speed 234
 - Manual flash 240, 254
 - Red-eye reduction 230
 - Shutter synchronization (1st/2nd curtain) 241
 - Wireless 241
 - Focus indicator 78
 - Focus lock 81
 - Focus mode switch 47, 137, 288
 - Focusing → AF
 - Focusing point (AF point) 120
 - Folder creation/selection 182
 - Food 89
 - Formatting 64
 - Frame rate 307
 - Full High-Definition (Full HD) 293, 307
 - Functions settable by shooting mode 460
- G**
- GPS 474
 - Grainy B/W 103, 268, 400
 - Grid display 71, 270, 331, 347
- H**
- Handheld Night Scene 93
 - HD (movie) 307
 - HDMI 363
 - HDMI CEC 374
 - HDR 207
 - HDR art bold 105
 - HDR art embossed 105
 - HDR art standard 104
 - HDR art vivid 105
 - HDR Backlight Control 94
 - Help 76
 - High-Definition (HD) movies 307
 - High ISO speed noise reduction ... 170
 - Highlight alert 351
 - Highlight tone priority 174
 - High-speed continuous shooting ... 138
 - Histogram (Brightness/RGB) 352
 - Hot shoe 26, 233
 - Household power 456
- I**
- ICC profile 181
 - Illumination (LCD panel) 55
 - Image dust prevention 403
 - Image review time 67
 - Image-recording quality 142, 306

Images

AF point display	352
Auto playback	369
Auto rotation	387
Erasing	378
File numbering	184
Highlight alert	351
Histogram	352
Index display	353
Jump display (image browsing)...	354
Magnification	355
Manual rotation	358
Playback	345
Protecting	376
Rating	359
Review time	67
Shooting information	348
Slide show	369
Viewing on a TV set	363, 373
Index display	353
INFO. button	258, 262, 300, 346, 450
Initializing the card (formatting).....	64
Interval timer	223
IPB (Light)	308
IPB (Standard)	308
ISO speed	148, 296, 299
Automatic setting (Auto)	150
Automatic setting range	152
ISO expansion	151
Manual setting range	151
Minimum shutter speed	153
Setting increments	413

J

JPEG	142
Jump display	354



K

























Kids	90
------------	----

L

Landscape	96
Language	46
Large (image-recording quality)	143, 395
Large Zone AF	120
LCD monitor	24, 40
Brightness adjustment	386
Electronic level	72
Image playback	345
Menu display	58, 470
Shooting function settings	55, 451
Vari-Angle	40, 82
LCD panel	28
Lens	25, 47
Chromatic aberration correction	176
Distortion correction	176
Lock release	48
Peripheral illumination correction	175
Lighting/scene-based shots	112
Live View shooting	82, 255
AF operation	116, 274
Aspect ratio	146
Creative filters	266
Exposure simulation	271
Face+Tracking	277
FlexiZone - Multi	279
FlexiZone - Single	281
Grid display	270
Information display	258
Manual focusing (MF)	288
Metering timer	273
Possible shots	257
Quick Control	265
Silent shooting	272
LOCK	54
Long exposure noise reduction	172
Long exposures	204
Low-speed continuous shooting	138

- M**
- M (Manual exposure) 196, 298
 - Macro photography 97
 - Magnified view 288, 355
 - Main Dial 51
 - Manual exposure 196, 298
 - Manual focusing (MF) 137, 288
 - Manual reset 185
 - Manual selection (AF point) 122
 - Maximum burst 143, 145
 - Medium
(image-recording quality) 143, 395
 - Memory cards → Cards
 - Menu 58
 - My Menu 440
 - Setting procedure 59
 - Settings 470
 - MENU** icon 8
 - Metering mode 198
 - Metering timer 273
 - MF (manual focusing) 137, 288
 - Microadjustment 427
 - Microphone 294, 313
 - Miniature effect 104, 269, 401
 - Miniature effect movies 318
 - Mirror lockup 219
 - Mode Dial 30, 51
 - Monochrome images 108, 155, 159
 - MOV 306
 - Movies 293
 - AE lock 295
 - AF method 304, 327
 - Attenuator 312
 - Autoexposure Shooting 294
 - Compression method 308
 - Creative filters 316
 - Editing out first and last scenes ... 367
 - Enjoying movies 363
 - External microphone 313
 - File size 309
 - Frame rate 307
 - Grid display 331
 - HDR Movie Shooting 314
 - Information display 300
 - Manual exposure shooting 298
 - Metering timer 331
 - Microphone 294, 313
 - Movie digital zoom 311
 - Movie recording size 306
 - Movie Servo AF 326
 - Playback 363, 365
 - Quick Control 305
 - Recording time 309
 - Sound recording 312
 - Time-lapse 319
 - Video snapshot album 333
 - Video snapshots 333
 - Viewing on a TV set 363, 373
 - Wind filter 312
 - MP4 306
 - M-RAW (Medium RAW) 143, 144
 - Multi function lock 54
 - Multi Shot Noise Reduction 170
 - Multi-controller 53
 - Multiple exposures 212
 - My Menu 440
- N**
- Night Portrait 92
 - Night scenes 92, 93
 - Noise reduction
 - High ISO speed 170
 - Long exposures 172
 - Nomenclature 26
 - Non-Canon flash units 234
 - Normal
(image-recording quality) 143, 144
 - NTSC 307, 475

- O**
- ONE SHOT (One-Shot AF)... 117, 274
- Orientation linked AF point 421
- P**
- P (Program AE) 190
- PAL 307, 475
- Partial metering..... 198
- Peripheral illumination correction... 175
- Personal white balance..... 165
- Photobook set-up..... 384
- Picture Style..... 154, 157, 160
- Pixel count 142
- Playback 345
- Portrait 95
- Possible shots..... 42, 143, 257
- Power
- Auto power off 66
 - Battery information 452
 - Battery level..... 42, 452
 - Household power 456
 - Possible shots 42, 257
 - Recharge 34
 - Recharge performance..... 452
- Pressing completely..... 50
- Pressing halfway..... 50
- Print order (DPOF)..... 380
- Program AE 190
- Program shift 191
- Protecting images 376
- Q**
-  (Quick Control)... 56, 106, 265, 305, 361
- Quick Control Dial..... 52
- R**
- Rating..... 359
- Rating mark..... 359
- RAW 142, 143, 144
- RAW image processing..... 390
- RAW+JPEG 142
- Recharging..... 34
- Red-eye reduction..... 230
- Reduced display..... 353
- Release shutter without card..... 38
- Remote control shooting 221
- Remote switch..... 221
- Resizing 395
- Rotation (image)..... 358, 387
- S**
- Safety precautions 20
- Safety shift 415
- Scene icons..... 260, 297
- Scene Intelligent Auto 78
- SD, SDHC, SDXC cards → Cards
- Second-curtain synchronization ... 241
- Self-timer..... 140, 222
- Sensitivity → ISO speed
- Sensor cleaning 403
- Sepia (Monochrome)..... 108, 159
- Servo AF 275
- Sharpness 158
- Shooting function settings 55, 451
- Shooting information display 348
- Shooting modes 30
- Av (Aperture-priority AE)..... 194
 - B (Bulb)..... 204
 -  (Custom shooting)..... 445
 - M (Manual exposure)..... 196
 - P (Program AE) 190
 - Tv (Shutter-priority AE)..... 192

-  (Scene Intelligent Auto) 78
-  (Creative Auto) 84
-  (Flash Off) 83
- SCN** (Special scene)
 -  (Food) 89
 -  (Kids) 90
 -  (Candlelight) 91
 -  (Night Portrait) 92
 -  (Handheld Night Scene) 93
 -  (HDR Backlight Control) 94
 -  (Portrait) 95
 -  (Landscape) 96
 -  (Close-up) 97
 -  (Sports) 98
-  (Creative filters) 101
-  (Grainy B/W) 103
-  (Soft focus) 103
-  (Fish-eye effect) 104
-  (Toy camera effect) 104
-  (Miniature effect) 104
-  (Water painting effect) 104
-  (HDR art standard) 104
-  (HDR art vivid) 105
-  (HDR art bold) 105
-  (HDR art embossed) 105
- Shutter button 50
- Shutter synchronization
 - (1st/2nd curtain) 241
- Shutter-priority AE 192
- Silent shooting
 - Silent continuous shooting 138
 - Silent LV shooting 272
 - Silent single shooting 138
- Single-image display 346
- Single-point AF 120
- Slide show 369
- Small
 - (image-recording quality) 143, 395
- Soft focus 103, 268, 400
- Software 512
- Sound-recording level 312
- Speaker 365
- Special scene mode (SCN) 88
- Speedlite → Flash
- Sports 98
- Spot metering 198
- S-RAW (Small RAW) 143, 144
- sRGB 181
- Stop down aperture 195, 256, 261
- Strap 33
- System map 468
- T**
 - Tapping 61
 - Temperature warning 290, 343
 - Time zone 43
 - Time-lapse movie 319
 - Tone priority 174
 - Toning effect (monochrome) 159
 - Touch beeping 62
 - Touch screen 61, 356
 - Touch shutter 286
 - Toy camera effect 104, 269, 401
 - Tripod socket 27
 - Troubleshooting 481
 - Tv (Shutter-priority AE) 192
- U**
 - USB (digital) terminal 515
- V**
 - Vari-Angle LCD monitor 40, 82
 - Video snapshot album 333
 - Video snapshots 333
 - Video system 307, 373, 475
 - Viewfinder 29
 - Dioptic adjustment 49
 - Electronic level 72
 - Flicker detection 74
 - Grid display 71

Viewing on a TV set..... 363, 373

Volume (movie playback)..... 366

W

Warning icon 425

Water painting effect 104, 268, 401

White balance (WB)..... 162

 Ambience priority (**AWB**) 163

 Bracketing 168

 Color temperature setting 166

 Correction 167

 Custom 164

 Personal 165

 White priority (**AWB**) 163

Wi-Fi/NFC 474

Wind filter 312

Wireless communication

 settings 474

Wireless flash shooting 244

Z

Zone AF 120

Canon

The descriptions in this Instruction Manual are current as of January 2016. For information on the compatibility with any products introduced after this date, contact any Canon Service Center. For the latest version Instruction Manual, refer to the Canon Web site.