

**Canon**

**EOS**  
***REBEL T6i***  
**EOS 750D**

**EOS REBEL T6i (W)**  
**EOS 750D (W)**



**INSTRUCTION  
MANUAL**

# Introduction

The EOS REBEL T6i or EOS 750D is a digital single-lens reflex camera featuring a fine-detail CMOS sensor with approx. 24.2 effective megapixels, DIGIC 6, high-precision and high-speed 19-point AF (cross-type AF point: max. 19 points), approx. 5.0 fps continuous shooting, Live View shooting, Full High-Definition (Full HD) movie shooting, and Wi-Fi/NFC function.

## **Before Starting to Shoot, Be Sure to Read the Following**

To avoid botched pictures and accidents, first read the “Safety Precautions” (p.20-22) and “Handling Precautions” (p.23-25).

## **Refer to This Manual while Using the Camera to Further Familiarize Yourself with the Camera**

While reading this manual, take a few test shots and see how they come out. You can then better understand the camera.

## **Testing the Camera Before Use and Liability**

After shooting, play images back and check whether they have been properly recorded. If the camera or memory card is faulty and the images cannot be recorded or downloaded to a computer, Canon cannot be held liable for any loss or inconvenience caused.

## **Copyrights**

Copyright laws in your country may prohibit the use of your recorded images or copyrighted music and images with music in the memory card for anything other than private enjoyment. Also be aware that certain public performances, exhibitions, etc., may prohibit photography even for private enjoyment.

# Item Check List

Before starting, check that all the following items are included with your camera. If anything is missing, contact your dealer.

---



**Camera**

(with eyecup and body cap)



**Battery Pack  
LP-E17**

(with protective cover)



**Battery Charger  
LC-E17/LC-E17E\***



**Wide Strap**



**Interface Cable**

\* Battery Charger LC-E17 or LC-E17E is provided. (The LC-E17E comes with a power cord.)

- The Instruction Manuals and CD-ROMs provided are listed on the next page.
- If you purchased a Lens Kit, check that the lenses are included.
- Depending on the Lens Kit type, lens instruction manuals may also be included.
- Be careful not to lose any of the above items.

# Instruction Manual and CD-ROMs

The instruction manual consists of a booklet and electronic manuals (PDF files on the CD-ROM). **The booklet is the Basic Instruction Manual. For more detailed instructions, see the Camera Instruction Manual on the CD-ROM.**

---



**Camera and Wi-Fi/NFC Function  
Basic Instruction Manual**



## **Camera Instruction Manual CD-ROM**

Contains the following manuals (PDF files):

- Camera Instruction Manual
- Wi-Fi/NFC Function Instruction Manual
- Quick Reference Guide

Instructions for viewing the Camera Instruction Manual CD-ROM are on pages 400-401.



## **EOS DIGITAL Solution Disk (Software CD-ROM)**

Contains software such as image-editing software and Software Instruction Manuals (PDF files).

For more information and installation procedures of the software, see pages 404-405.

Instructions for viewing the Software Instruction Manual are on page 406.

## Compatible Cards

The camera can use the following cards regardless of capacity: **If the card is new or was previously formatted by another camera or computer, format the card with this camera (p.59).**

- SD memory cards
- SDHC memory cards\*
- SDXC memory cards\*

\* UHS-I cards supported.

### Cards that Can Record Movies

**When shooting movies, use a large-capacity SD card rated SD Speed Class 6 “CLASS 6” or higher.**

- If you use a slow-writing card when shooting movies, the movie may not be recorded properly. Also, if you play back a movie on a card with a slow reading speed, the movie may not play back properly.
- If you want to shoot still photos while shooting a movie, you will need an even faster card.
- To check the card's reading/writing speed, refer to the card manufacturer's Web site.



In this manual, “card” refers to SD memory cards, SDHC memory cards, and SDXC memory cards.

\* **The camera does not come with a card for recording images/movies.** Please purchase it separately.

# Quick Start Guide

1

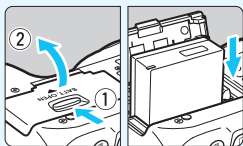

**Insert the battery** (p.36).

- To charge the battery, see page 34.

2

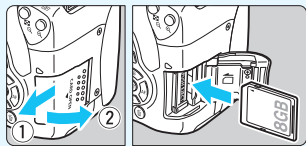

**Insert the card** (p.37).

- With the card's label facing toward the back of the camera, insert it into the card slot.

3

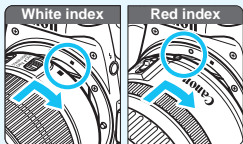

**Attach the lens** (p.45).

- Align the lens's white or red mount index with the camera's mount index of the same color.

4

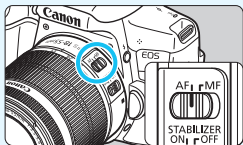

**Set the lens focus mode switch to <AF>** (p.45).

5

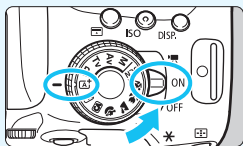

**Set the power switch to <ON>, then set the Mode Dial to <A+> (Scene Intelligent Auto)** (p.66).

- All the necessary camera settings will be set automatically.

6

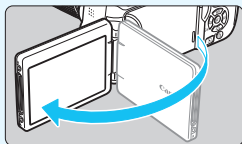
**Flip out the LCD monitor** (p.39).

- When the LCD monitor displays the date/time/zone setting screens, see page 42.

7

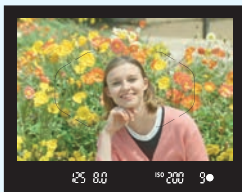
**Focus on the subject** (p.50).

- Look through the viewfinder and aim the viewfinder center over the subject.
- Press the shutter button halfway, and the camera will focus on the subject.
- If necessary, the built-in flash will be raised.

8

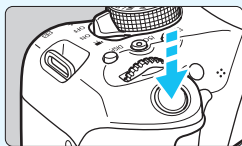
**Take the picture** (p.50).

- Press the shutter button completely to take the picture.



9

**Review the picture.**

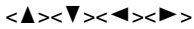

- The captured image will be displayed for 2 sec. on the LCD monitor.
- To display the image again, press the <▶> button (p.97).
- To shoot while looking at the LCD monitor, see “Live View Shooting” (p.191).
- To view the images captured so far, see “Image Playback” (p.97).
- To delete an image, see “Erasing Images” (p.304).

# Conventions Used in this Manual

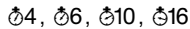
## Icons in this Manual

-  : Indicates the Main Dial.
-  : Indicates the  cross keys on the top, bottom, left, and right.
-  : Indicates the Setting button.
-  : Indicates that each function remains active for 4 sec., 6 sec., 10 sec., or 16 sec. after you let go of the button.

\* In this manual, the icons and markings indicating the camera's buttons, dials, and settings correspond to the icons and markings on the camera and on the LCD monitor.

- MENU** : Indicates a function that can be changed by pressing the <MENU> button to change its settings.
- ☆ : When shown on the upper right of a page, it indicates that the function is available only in the Creative Zone modes (p.30).
- (p.\*\*)
-  : Warning to prevent shooting problems.
-  : Supplemental information.
-  : Tips or advice for better shooting.
- ?

## Basic Assumptions

- All operations explained in this manual assume that the power switch is set to <ON> (p.40).
- It is assumed that all the menu settings, Custom Functions, etc. are set to their defaults.
- The illustrations in this manual show the camera attached with the EF-S18-55mm f/3.5-5.6 IS STM lens as an example.



# Chapters

	Introduction	2
<b>1</b>	<b>Getting Started</b>	33
<b>2</b>	<b>Basic Shooting and Image Playback</b>	65
<b>3</b>	<b>Setting the AF and Drive Modes</b>	99
<b>4</b>	<b>Image Settings</b>	115
<b>5</b>	<b>Advanced Operations</b>	147
<b>6</b>	<b>Flash Photography</b>	165
<b>7</b>	<b>Shooting with the LCD Monitor (Live View Shooting)</b>	191
<b>8</b>	<b>Shooting Movies</b>	221
<b>9</b>	<b>Handy Features</b>	255
<b>10</b>	<b>Image Playback</b>	277
<b>11</b>	<b>Post-Processing Images</b>	311
<b>12</b>	<b>Printing Images</b>	319
<b>13</b>	<b>Customizing the Camera</b>	335
<b>14</b>	<b>Reference</b>	347
<b>15</b>	<b>Viewing the CD-ROM Instruction Manuals / Downloading Images to Your Computer</b>	399



## Contents at a Glance

### Shooting

- **Shoot automatically** → **p.65-96** (Basic Zone modes)
- **Shoot continuously** → **p.112** (📄 Continuous shooting)
- **Take a picture of yourself in a group** → **p.114** (⌚ Self-timer)
- **Freeze the action** → **p.150** (Tv Shutter-priority AE)
- **Blur the action**
- **Blur the background** → **p.72** (📷 Creative Auto)
- **Keep the background in sharp focus** → **p.152** (Av Aperture-priority AE)
- **Adjust the image brightness (exposure)** → **p.159** (Exposure compensation)
- **Shoot in low light** → **p.66, 166** (⚡ Flash photography)  
**p.122** (ISO speed setting)
- **Shoot without flash** → **p.71** (📷 Flash Off)  
**p.89** (🔇 Flash off)
- **Shoot fireworks at night** → **p.156** (Bulb exposure)
- **Shoot while viewing the LCD monitor** → **p.191** (📺 Live View shooting)
- **Use Creative filters** → **p.200** (Creative filters)
- **Shoot movies** → **p.221** (🎬 Movie shooting)

### Image Quality

- **Shoot with image effects matching the subject** → **p.125** (Picture Style)
- **Make a large-size print of the picture** → **p.116** (📐L, 📐L, RAW)





- Take many pictures → p.116 (▲ S1, ▲ S1, S2, S3)

## AF (Focusing)

- Change the AF area selection mode → p.104 (☐ AF area selection mode)
- Shoot a moving subject → p.79, 81, 102 (AI Servo AF)

## Playback

- View the images on the camera → p.97 (▶ Playback)
- Search for pictures quickly → p.278 (☒ Index display)  
p.279 (🔍 Image browsing)
- Rate images → p.284 (Ratings)
- Prevent important images from accidental deletion → p.302 (🔒 Image protect)
- Delete unnecessary images → p.304 (🗑 Delete)
- Auto play back images and movies → p.294 (Slide show)
- View the photos or movies on a TV set → p.298 (Video OUT)
- Adjust the LCD monitor brightness → p.258 (LCD monitor brightness)
- Apply special effect to images → p.312 (Creative filters)

## Printing

- Print pictures easily → p.319 (Direct printing)



# Index to Features

## Power

- **Battery**
  - Charging → p.34
  - Installing/Removing → p.36
  - Battery check → p.41
  - Checking battery information → p.348
- **Household power outlet** → p.349
- **Auto power off** → p.40

## Cards

- **Installing/Removing** → p.37
- **Formatting** → p.59
- **Release shutter without card** → p.256

## Lens

- **Attaching/Detaching** → p.45
- **Zoom** → p.46
- **Image Stabilizer** → p.48

## Basic Settings

- **Dioptic adjustment** → p.49
- **Language** → p.44
- **Date/Time/Zone** → p.42
- **Beeper** → p.256

## LCD Monitor

- **Using the LCD Monitor** → p.39
- **LCD Off/On** → p.270
- **Brightness adjustment** → p.258
- **Touch screen** → p.56

## Recording Images

- **Creating/Selecting a folder** → p.259
- **File numbering** → p.261

## AF

- **AF operation** → p.100
- **AF area selection mode** → p.104
- **AF point selection** → p.106
- **Manual focusing** → p.111

## Drive

- **Drive mode** → p.112
- **Self-timer** → p.114
- **Maximum burst** → p.118

## Image Quality

- **Image-recording quality** → p.116
- **Picture Style** → p.125
- **White balance** → p.132
- **Auto Lighting Optimizer** → p.136
- **Noise reduction for long exposures** → p.138
- **Noise reduction for high ISO speeds** → p.137
- **Lens aberration correction** → p.140
- **Reducing flicker** → p.144
- **Highlight tone priority** → p.339
- **Color space** → p.146

## Shooting

- **Shooting mode** → p.30
- **Feature guide** → p.64
- **ISO speed** → p.122
- **Aspect ratio** → p.120
- **Bulb** → p.156
- **Metering mode** → p.157
- **Mirror lockup** → p.163
- **Remote control** → p.350

**Exposure Adjustment**

- Exposure compensation → p.159
- AEB → p.160
- AE lock → p.162

**Flash**

- Built-in flash → p.166
- External flash → p.171
- Flash function settings → p.173
- Wireless shooting → p.179

**Live View Shooting**

- Live View shooting → p.191
- AF method → p.206
- Continuous AF → p.204
- Touch Shutter → p.214
- Creative filters → p.200

**Movie Shooting**

- Movie shooting → p.221
- AF method → p.206
- Movie recording size → p.233
- Movie Servo AF → p.248
- Sound recording → p.251
- Manual exposure → p.225
- Still photo shooting → p.230
- Miniature Effect Movies → p.236
- Video snapshot → p.238

**Playback**

- Image review time → p.257
- Single-image display → p.97
- Shooting information display → p.306
- Index display → p.278
- Image browsing (Jump display) → p.279
- Magnified view → p.280
- Image rotate → p.283
- Rating → p.284
- Movie playback → p.290
- Slide show → p.294
- Viewing images on a TV set → p.298
- Protect → p.302
- Erase → p.304

**Image Editing**

- Creative filters → p.312
- Resize → p.315
- Cropping → p.317

**Printing**

→ p.322

**Customization**

- Custom Functions (C.Fn) → p.336
- My Menu → p.346

**Software**

→ p.399





**Wi-Fi/NFC function**

→ Wi-Fi/NFC Function Instruction Manual

















# Contents

<b>Introduction</b>	<b>2</b>
Item Check List.....	3
Instruction Manual and CD-ROMs .....	4
Compatible Cards.....	5
Quick Start Guide .....	6
Conventions Used in this Manual.....	8
Chapters.....	9
Contents at a Glance.....	10
Index to Features .....	12
Contents .....	14
Safety Precautions .....	20
Handling Precautions .....	23
Nomenclature .....	26



## **1 Getting Started** **33**

Charging the Battery .....	34
Installing and Removing the Battery.....	36
Installing and Removing the Card .....	37
Using the LCD Monitor .....	39
Turning on the Power .....	40
Setting the Date, Time, and Zone.....	42
Selecting the Interface Language.....	44
Attaching and Detaching a Lens.....	45
Lens Image Stabilizer .....	48
Basic Operation.....	49
 Quick Control for Shooting Functions.....	51
 Menu Operations.....	53
 Using the Touch Screen .....	56
Formatting the Card .....	59
Switching the LCD Monitor Display .....	61
 Displaying the Grid .....	62
Displaying the Flicker Detection .....	63
Feature Guide .....	64

## 2 Basic Shooting and Image Playback 65





 Fully Automatic Shooting (Scene Intelligent Auto) .....	66
 Full Auto Techniques (Scene Intelligent Auto).....	69
 Disabling Flash .....	71
 Creative Auto Shooting.....	72
 Shooting Portraits .....	76
 Shooting Landscapes .....	77
 Shooting Close-ups.....	78
 Shooting Moving Subjects .....	79
<b>SCN</b> : Special Scene Mode .....	80
 Shooting Children .....	81
 Shooting Food .....	82
 Shooting Candlelight Portraits .....	83
 Shooting Night Portraits (With a Tripod) .....	84
 Shooting Night Scenes (Handheld).....	85
 Shooting Backlit Scenes.....	86
 Quick Control.....	88
Shoot by Ambience Selection .....	90
Shoot by Lighting or Scene Type .....	94
 Image Playback .....	97

## 3 Setting the AF and Drive Modes 99



AF: Changing the Autofocus Operation .....	100
 Selecting the AF Area and AF Point .....	104
AF Area Selection Modes .....	107
Subjects Difficult to Focus on.....	110
MF: Manual Focus .....	111
 Selecting the Drive Mode .....	112
 Using the Self-timer .....	114

## 4 Image Settings 115



Setting the Image-Recording Quality .....	116
Changing the Image's Aspect Ratio.....	120
<b>ISO</b> : Changing the ISO Speed to Suit the Light.....	122

 Selecting a Picture Style .....	125
 Customizing a Picture Style .....	127
 Registering a Picture Style .....	130
<b>WB</b> : Matching the Light Source (White balance) .....	132
 Adjusting the Color Tone for the Light Source .....	134
Auto Correction of Brightness and Contrast (Auto Lighting Optimizer) ...	136
Setting Noise Reduction .....	137
Correction of Lens Peripheral Illumination and Aberrations .....	140
Reducing Flicker .....	144
Setting the Color Reproduction Range (Color space) .....	146

## 5 Advanced Operations 147

<b>P</b> : Program AE .....	148
<b>Tv</b> : Conveying the Subject's Movement (Shutter priority AE) .....	150
<b>Av</b> : Changing the Depth of Field (Aperture priority AE) .....	152
Depth-of-Field Preview .....	154
<b>M</b> : Manual Exposure .....	155
 Changing the Metering Mode (Metering mode) .....	157
Setting Exposure Compensation (Exposure comp.) .....	159
Auto Exposure Bracketing (AEB) .....	160
 Locking the Exposure (AE Lock) .....	162
Mirror Lockup to Reduce Camera Shake .....	163



## 6 Flash Photography 165

 Using the Built-in Flash .....	166
 Using an External Speedlite .....	171
Setting the Flash .....	173
Using Wireless Flash .....	179
Easy Wireless Flash Shooting .....	182
Custom Wireless Flash Shooting .....	185

## 7 Shooting with the LCD Monitor (Live View Shooting) 191

 Shooting with the LCD Monitor .....	192
Shooting Function Settings .....	198



 Applying Creative Filters .....	200
Menu Function Settings .....	204
Using AF to Focus (AF Method) .....	206
 Shooting with the Touch Shutter .....	214
MF: Focusing Manually .....	216

## **8 Shooting Movies 221**











 Shooting Movies .....	222
Autoexposure Shooting .....	222
Manual Exposure Shooting .....	225
Shooting Still Photos .....	230
Shooting Function Settings .....	232
Setting the Movie Recording Size .....	233
Shooting Miniature Effect Movies .....	236
Shooting Video Snapshots .....	238
Menu Function Settings .....	248

## **9 Handy Features 255**



Handy Features .....	256
Disabling the Beeper .....	256
Card Reminder .....	256
Setting the Image Review Time .....	257
Setting the Auto Power-off Time .....	257
Adjusting the LCD Monitor Brightness .....	258
Creating and Selecting a Folder .....	259
File Numbering Methods .....	261
Setting Copyright Information .....	263
Auto Rotation of Vertical Images .....	265
INFO.: Checking Camera Settings .....	266
Reverting the Camera to the Default Settings .....	267
LCD Monitor Off/On Setting .....	270
Changing the Shooting Settings Screen Color .....	270

 Automatic Sensor Cleaning .....	271
Appending Dust Delete Data .....	272
Manual Sensor Cleaning .....	274





## 10 Image Playback 277

 Searching for Images Quickly .....	278
 /  Magnified View .....	280
 Playing Back with the Touch Screen .....	281
 Rotating the Image .....	283
Setting Ratings .....	284
 Quick Control for Playback .....	286
 Enjoying Movies .....	288
 Playing Back Movies .....	290
 Editing a Movie's First and Last Scenes .....	292
Slide Show (Auto Playback) .....	294
Viewing Images on a TV Set .....	298
 Protecting Images .....	302
 Erasing Images .....	304
INFO.: Shooting Information Display .....	306

## 11 Post-Processing Images 311

 Applying Creative Filters .....	312
 Resizing JPEG Images .....	315
 Cropping JPEG Images .....	317

## 12 Printing Images 319

Preparing to Print .....	320
 Printing .....	322
Cropping the Image .....	327
 Digital Print Order Format (DPOF) .....	329
 Direct Printing of Print-Ordered Images .....	332
 Specifying Images for a Photobook .....	333

<b>13</b>	<b>Customizing the Camera</b>	<b>335</b>
	Setting Custom Functions.....	336
	Custom Function Settings.....	338
	C.Fn I : Exposure .....	338
	C.Fn II : Image .....	339
	C.Fn III : Autofocus/Drive .....	340
	C.Fn IV : Operation/Others.....	343
	Registering My Menu .....	346
<b>14</b>	<b>Reference</b>	<b>347</b>
	Checking the Battery Information.....	348
	Using a Household Power Outlet.....	349
	Remote Control Shooting.....	350
	Using Eye-Fi Cards .....	352
	Function Availability Table by Shooting Mode.....	354
	System Map .....	360
	Menu Settings .....	362
	Troubleshooting Guide.....	369
	Error Codes.....	382
	Handling Precautions: STM Lenses (Kit Lenses) .....	383
	Specifications .....	384
<b>15</b>	<b>Viewing the CD-ROM Instruction Manuals / Downloading Images to Your Computer</b>	<b>399</b>
	Viewing the Camera Instruction Manual CD-ROM.....	400
	Downloading Images to a Computer.....	402
	Software Overview .....	404
	Installing the Software .....	405
	Software Instruction Manual .....	406
	Index .....	407

# Safety Precautions

The following precautions are provided to prevent harm or injury to yourself and others. Make sure to thoroughly understand and follow these precautions before using the product.

**If you experience any malfunctions, problems, or damage to the product, contact the nearest Canon Service Center or the dealer from whom you purchased the product.**



## Warnings

Follow the warnings below. Otherwise, death or serious injuries may result.

- To prevent fire, excessive heat, chemical leakage, explosions, and electrical shock, follow the safeguards below:
  - Do not use any batteries, power sources, or accessories not specified in the Instruction Manual. Do not use any home-made or modified batteries.
  - Do not short-circuit, disassemble, or modify the battery. Do not apply heat or solder to the battery. Do not expose the battery to fire or water. Do not subject the battery to strong physical shock.
  - Do not insert the battery's plus and minus ends incorrectly.
  - Do not recharge the battery in temperatures outside the allowable ambient temperature range. Also, do not exceed the recharging time indicated in the Instruction Manual.
  - Do not insert any foreign metallic objects into the electrical contacts of the camera, accessories, connecting cables, etc.
- When disposing of a battery, insulate the electrical contacts with tape to prevent contact with other metallic objects or batteries. This is to prevent a fire or an explosion.
- If excessive heat, smoke, or fumes are emitted when recharging the battery, immediately unplug the battery charger from the power outlet to stop recharging. Otherwise, it may cause a fire, heat damage, or electrical shock.
- If the battery leaks, changes color, deforms, or emits smoke or fumes, remove it immediately. Be careful not to get burned in the process. It may cause a fire, electrical shock or skin burn if you keep using it.
- Prevent any battery leakage from contacting your eyes, skin, and clothing. It can cause blindness or skin problems. If the battery leakage contacts your eyes, skin, or clothing, flush the affected area with lots of clean water without rubbing it. See a physician immediately.
- Do not leave any cords near a heat source. It can deform the cord or melt the insulation and cause a fire or electrical shock.
- Do not hold the camera in the same position for long periods of time. Even if the camera does not feel too hot, prolonged contact with the same body part may cause skin redness, blistering or low-temperature contact burns. Using a tripod is recommended for people with circulation problems or very sensitive skin, or when using the camera in very hot places.
- Do not fire the flash at anyone driving a car or other vehicle. It may cause an accident.

- Do not fire the flash near a person's eyes. It may impair the person's vision. When using flash to photograph an infant, keep at least 1 meter/3.3 feet away.
- When the camera or accessories are not in use, make sure to remove the battery and disconnect the power plug from the equipment before storing. This is to prevent electrical shock, excessive heat, fire, or corrosion.
- Do not use the equipment where there is flammable gas. This is to prevent an explosion or a fire.
- If you drop the equipment and the casing breaks open to expose the internal parts, do not touch the internal parts. There is a possibility of an electrical shock.
- Do not disassemble or modify the equipment. High-voltage internal parts can cause electrical shock.
- Do not look at the sun or an extremely bright light source through the camera or lens. Doing so may damage your vision.
- Keep equipment out of the reach of children and infants, including when in use. Straps or cords may accidentally cause choking, electrical shock, or injury. Choking or injury may also occur if a child or infant accidentally swallows a camera part or accessory. If a child or infant swallows a part or accessory, consult a physician immediately.
- Do not use or store the equipment in dusty or humid places. Likewise, store the battery with its protective cover attached to prevent short-circuit. This is to prevent a fire, excessive heat, electrical shock, or burn.
- Before using the camera inside an airplane or hospital, check if it is allowed. Electromagnetic waves emitted by the camera may interfere with the plane's instruments or the hospital's medical equipment.
- To prevent a fire and electrical shock, follow the safeguards below:
  - Always insert the power plug all the way in.
  - Do not handle a power plug with wet hands.
  - When unplugging a power plug, grasp and pull the plug instead of the cord.
  - Do not scratch, cut, or excessively bend the cord or put a heavy object on the cord. Also do not twist or tie the cords.
  - Do not connect too many power plugs to the same power outlet.
  - Do not use a cord whose wire is broken or insulation is damaged.
- Unplug the power plug periodically and clean off the dust around the power outlet with a dry cloth. If the surrounding is dusty, humid, or oily, the dust on the power outlet may become moist and short-circuit the outlet, causing a fire.
- Do not connect the battery directly to an electrical outlet or a car's cigarette lighter outlet. The battery may leak, generate excessive heat or explode, causing a fire, burns or injuries.
- A thorough explanation of how to use the product by an adult is required when the product is used by children. Supervise children while they are using the product. Incorrect usage may result in electrical shock or injury.
- Do not leave a lens or lens-attached camera in the sun without the lens cap attached. Otherwise, the lens may concentrate the sun's rays and cause a fire.
- Do not cover or wrap the product with a cloth. Doing so may trap heat within and cause the casing to deform or catch fire.
- Be careful not to get the camera wet. If you drop the product in the water or if water or metal get inside the product, promptly remove the battery. This is to prevent a fire and an electrical shock.
- Do not use paint thinner, benzene, or other organic solvents to clean the product. Doing so may cause fire or a health hazard.



### Cautions

Follow the cautions below. Otherwise, physical injury or property damage may result.

- Do not use or store the product inside a car under the hot sun or near a heat source. The product may become hot and cause skin burns. Doing so may also cause battery leakage or explosion, which will degrade the performance or shorten the life of the product.
- Do not carry the camera around when it is attached to a tripod. Doing so may cause injury. Also make sure the tripod is sturdy enough to support the camera and lens.
- Do not leave the product in a low-temperature environment for an extended period of time. The product will become cold and may cause injury when touched.
- Never play the provided CD-ROM in a drive that is not compatible with the CD-ROM. If you use it in a music CD player, you may damage the speakers and other components. When using headphones, there is also a risk of injury to your ears from excessively loud volume.

# Handling Precautions

## Camera Care

- This camera is a precision instrument. Do not drop it or subject it to physical shock.
- The camera is not waterproof and cannot be used underwater. If you accidentally drop the camera into water, promptly consult the nearest Canon Service Center. Wipe off any water droplets with a dry and clean cloth. If the camera has been exposed to salty air, wipe it with a well-wrung wet cloth.
- Never leave the camera near anything having a strong magnetic field such as a magnet or electric motor. Also avoid using or leaving the camera near anything emitting strong radio waves, such as a large antenna. Strong magnetic fields can cause camera misoperation or destroy image data.
- Do not leave the camera in excessive heat, such as in a car in direct sunlight. High temperatures can cause the camera to malfunction.
- The camera contains precision electronic circuitry. Never attempt to disassemble the camera yourself.
- Do not block the built-in flash, mirror operation with your finger, etc. Doing so may cause a malfunction.
- Use a blower to blow away dust on the lens, viewfinder, reflex mirror, and focusing screen. Do not use cleaners that contain organic solvents to clean the camera body or lens. For stubborn dirt, take the camera to the nearest Canon Service Center.
- Do not touch the camera's electrical contacts with your fingers. This is to prevent the contacts from corroding. Corroded contacts can cause camera misoperation.
- If the camera is suddenly brought in from the cold into a warm room, condensation may form on the camera and internal parts. To prevent condensation, first put the camera in a sealed plastic bag and let it adjust to the warmer temperature before taking it out of the bag.
- If condensation forms on the camera, do not use the camera. This is to avoid damaging the camera. If there is condensation, remove the lens, card and battery from the camera, and wait until condensation has evaporated before using the camera.
- If the camera will not be used for an extended period, remove the battery and store the camera in a cool, dry, well-ventilated location. Even while the camera is in storage, press the shutter button a few times once in a while to check that the camera is still working.

- Avoid storing the camera where there are chemicals that result in rust and corrosion such as in a chemical lab.
- If the camera has not been used for an extended period, test all its functions before using it. If you have not used the camera for some time or if there is an important shoot such as a foreign trip coming up, have the camera checked by your nearest Canon Service Center or check the camera yourself and make sure it is working properly.
- If you use continuous shooting, Live View shooting, or movie shooting for a prolonged period, the camera may become hot. This is not a malfunction.
- If there is a bright light source inside or outside the image area, ghosting may occur.

### LCD Monitor

- Although the LCD monitor is manufactured with very high precision technology with over 99.99% effective pixels, there may be a few dead pixels displaying only black or red, etc. among the remaining 0.01% or less pixels. Dead pixels are not a malfunction. They do not affect the images recorded.
- If the LCD monitor is left on for a prolonged period, screen burn-in may occur where you see remnants of what was displayed. However, this is only temporary and will disappear when the camera is left unused for a few days.
- The LCD monitor display may seem slow in low temperatures, or look black in high temperatures. It will return to normal at room temperature.

### Cards

To protect the card and its recorded data, note the following:

- Do not drop, bend, or wet the card. Do not subject it to excessive force, physical shock, or vibration.
- Do not touch the card's electronic contacts with your fingers or anything metallic.
- Do not affix any stickers, etc., on the card.
- Do not store or use the card near anything that has a strong magnetic field, such as a TV set, speakers, or magnet. Also avoid places prone to having static electricity.
- Do not leave the card in direct sunlight or near a heat source.
- Store the card in a case.
- Do not store the card in hot, dusty, or humid locations.



### Smudges Adhering to the Front of the Sensor

Besides dust entering the camera from outside, in rare cases lubricant from the camera's internal parts may adhere to the front of the sensor. If visible spots remain on the image, having the sensor cleaned by a Canon Service Center is recommended.

### Lens

After detaching the lens from the camera, put down the lens with the rear end up and attach the rear lens cap to avoid scratching the lens surface and electrical contacts.



# Nomenclature

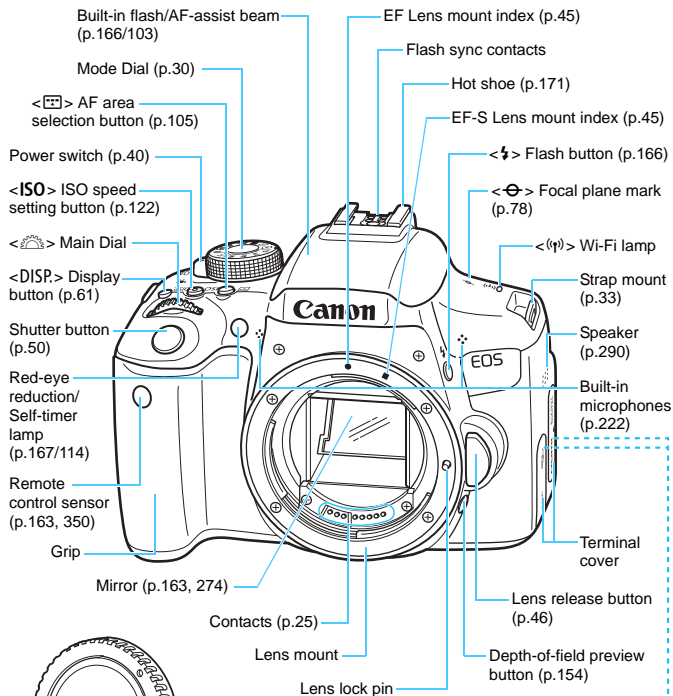

Body cap (p.45)

<A/V OUT/DIGITAL>  
Audio/video OUT/  
Digital terminal (p.301, 320, 402)

<Remote control terminal>  
(p.351)

<MIC> External microphone  
IN terminal (p.251)

<HDMI OUT> HDMI mini OUT terminal  
(p.298)

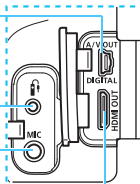

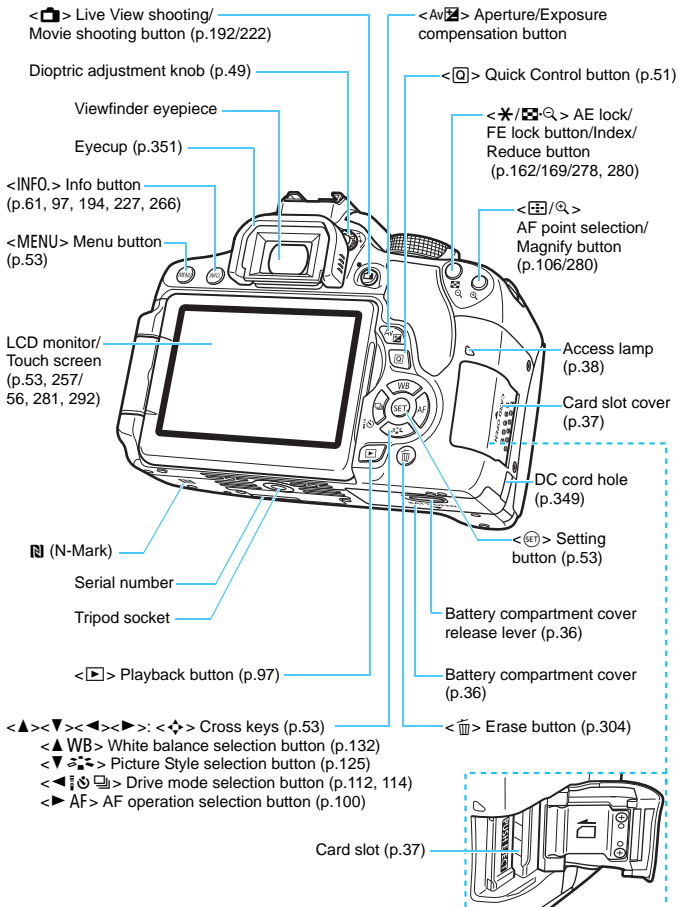

## Shooting Function Settings (in Creative Zone modes, p.30)

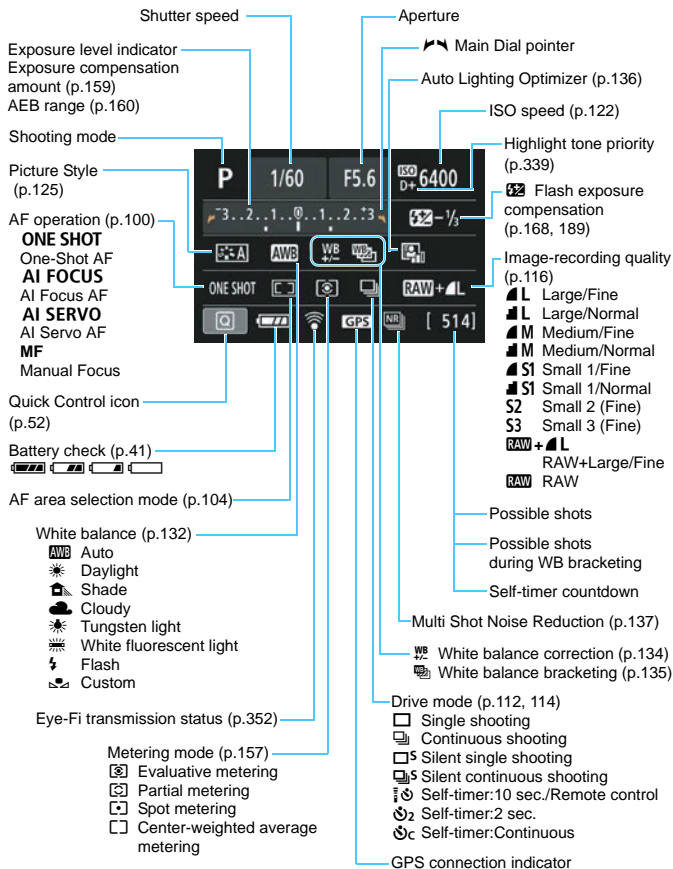

The display will show only the settings currently applied.

## Viewfinder Information

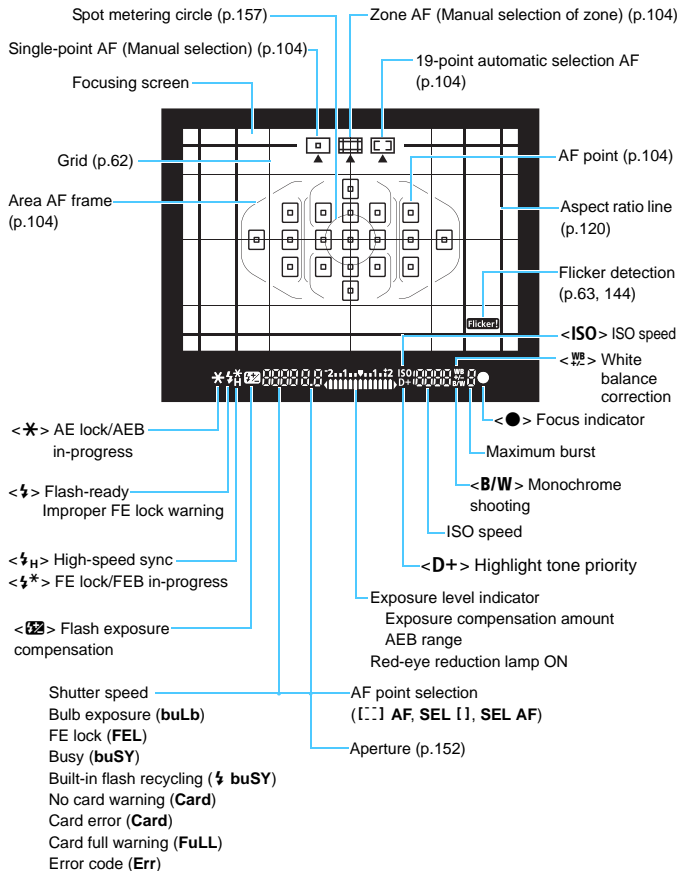

The display will show only the settings currently applied.

## Mode Dial

The Mode Dial consists of two functionally categorized zones: one for the Creative Zone modes and one for the Basic Zone modes.

### Creative Zone

These modes give you more control for shooting various subjects as desired.

- P** : Program AE (p.148)
- Tv** : Shutter-priority AE (p.150)
- Av** : Aperture-priority AE (p.152)
- M** : Manual exposure (p.155)

### Basic Zone

All you do is press the shutter button. The camera sets everything to suit the subject or scene for shooting.

- A+** : Scene Intelligent Auto (p.66)
- [Flash Off]** : Flash Off (p.71)
- CA** : Creative Auto (p.72)
- [Portrait]** : Portrait (p.76)
- [Landscape]** : Landscape (p.77)
- [Close-up]** : Close-up (p.78)
- [Sports]** : Sports (p.79)
- SCN**: Special scene (p.80)
  - [Kids]** : Kids (p.81)
  - [Food]** : Food (p.82)
  - [Candlelight]** : Candlelight (p.83)
  - [Night Portrait]** : Night Portrait (p.84)
  - [Handheld Night Scene]** : Handheld Night Scene (p.85)
  - [HDR Backlight Control]** : HDR Backlight Control (p.86)

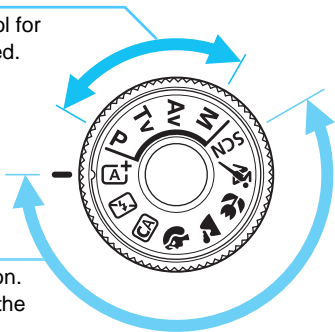

## Lens without a Distance Scale

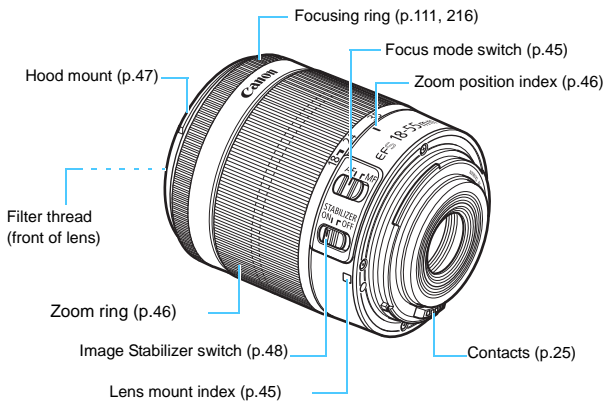

## Battery Charger LC-E17

Charger for Battery Pack LP-E17 (p.34).

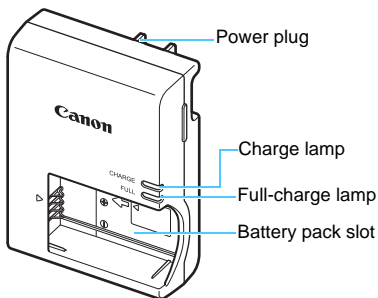

**IMPORTANT SAFETY INSTRUCTIONS-SAVE THESE INSTRUCTIONS.  
DANGER-TO REDUCE THE RISK OF FIRE OR ELECTRIC SHOCK,  
CAREFULLY FOLLOW THESE INSTRUCTIONS.**

For connection to a supply not in the U.S.A., use an attachment plug adapter of the proper configuration for the power outlet, if needed.

## Battery Charger LC-E17E

Charger for Battery Pack LP-E17 (p.34).

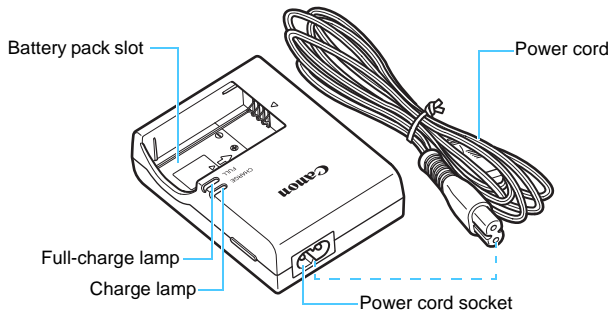



# 1

## Getting Started

This chapter explains preparatory steps before you start shooting and basic camera operations.

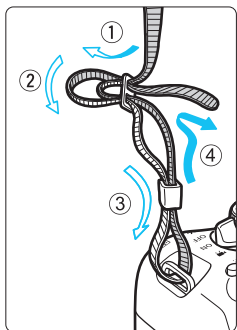

### Attaching the Provided Strap

Pass the end of the strap through the camera's strap mount eyelet from the bottom. Then pass it through the strap's buckle as shown in the illustration. Pull the strap to take up any slack and make sure the strap will not loosen from the buckle.

- The eyepiece cover is also attached to the strap (p.351).

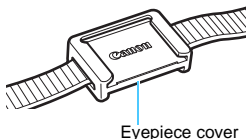

Eyepiece cover

# Charging the Battery

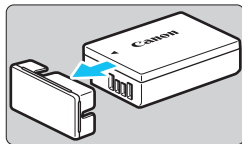

## 1 Remove the protective cover.

- Detach the protective cover provided with the battery.

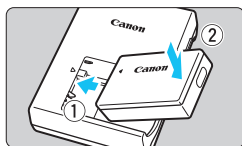

## 2 Attach the battery.

- As shown in the illustration, attach the battery securely to the charger.
- To detach the battery, follow the above procedure in reverse.

### LC-E17

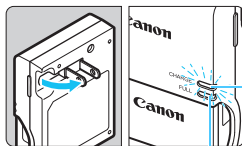

## 3 Recharge the battery.

### For LC-E17

- As shown by the arrow, flip out the battery charger's prongs and insert the prongs into a power outlet.

### For LC-E17E

- Connect the power cord to the charger and insert the plug into a power outlet.

Full-charge lamp

Charge lamp

### LC-E17E

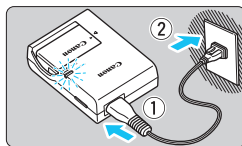

- ▶ Recharging starts automatically and the charge lamp lights up in orange.
- ▶ When the battery is fully recharged, the full-charge lamp will light up in green.

- It takes approx. 2 hours to fully recharge a completely exhausted battery at room temperature (23°C / 73°F). The time required to recharge the battery will vary greatly depending on the ambient temperature and the battery's remaining capacity.
- For safety reasons, recharging in low temperatures (5°C - 10°C / 41°F - 50°F) will take longer (up to approx. 4 hours).



## Tips for Using the Battery and Charger

- **Upon purchase, the battery is not fully charged.**  
Charge the battery before use.
  - **Recharge the battery on the day before or on the day it is to be used.**  
Even during storage, a charged battery will gradually drain and lose its capacity.
  - **After recharging the battery, detach it and disconnect the charger from the power outlet.**
  - **When not using the camera, remove the battery.**  
If the battery is left in the camera for a prolonged period, a small amount of power current is released, resulting in excess discharge and shorter battery life. Store the battery with the protective cover (provided) attached. Storing the battery when it is fully charged may lower the battery's performance.
  - **The battery charger can also be used in foreign countries.**  
The battery charger is compatible with a 100 V AC to 240 V AC 50/60 Hz power source. If necessary, attach a commercially-available plug adapter for the respective country or region. Do not attach any portable voltage transformer to the battery charger. Doing so can damage the battery charger.
  - **If the battery becomes exhausted quickly even after being fully charged, the battery has reached the end of its service life.**  
Check the battery's recharge performance (p.348) and purchase a new battery.
- After disconnecting the charger's power plug, do not touch the prongs for at least 5 sec.
  - Do not charge any battery other than a Battery Pack LP-E17.
  - Battery Pack LP-E17 is dedicated to Canon products only. Using it with an incompatible battery charger or product may result in malfunction or accidents for which Canon cannot be held liable.

# Installing and Removing the Battery

Load a fully charged Battery Pack LP-E17 into the camera. The camera's viewfinder becomes bright when a battery is installed, and darkens when the battery is removed.

## Installing the Battery

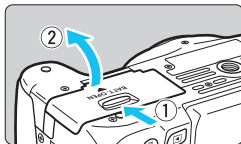

### 1 Open the cover.

- Slide the lever as shown by the arrows and open the cover.

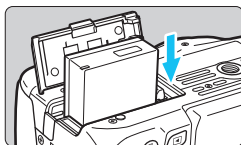

### 2 Insert the battery.

- Insert the end with the battery contacts.
- Insert the battery until it locks in place.

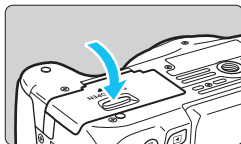

### 3 Close the cover.

- Press the cover until it snaps shut.

## Removing the Battery

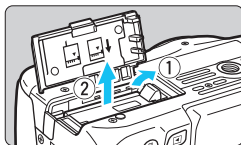

### Open the cover and remove the battery.

- Press the battery release lever as shown by the arrow and remove the battery.
- To prevent short circuiting of the battery contacts, be sure to attach the protective cover (provided, p.34) to the battery.

⚠ After opening the battery compartment cover, be careful not to forcefully swing it back further. Otherwise, the hinge may break.

# Installing and Removing the Card

The card (sold separately) can be an SD, SDHC, or SDXC memory card. SDHC and SDXC memory cards with UHS-I can also be used. The captured images are recorded onto the card.

- **Make sure the card's write-protect switch is set upward to enable writing and erasing.**

## Installing the Card

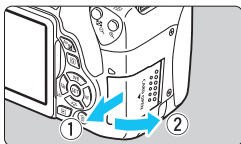

### 1 Open the cover.

- Slide the cover as shown by the arrows to open it.

Write-protect switch

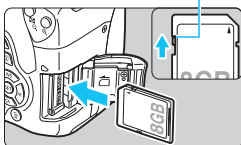

### 2 Insert the card.

- As shown by the illustration, face the card's label side toward you and insert it until it clicks in place.

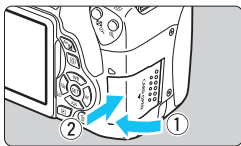

### 3 Close the cover.

- Close the cover and slide it in the direction shown by the arrows until it snaps shut.
- When you set the power switch to <ON>, the number of possible shots will be displayed on the LCD monitor.



Possible shots



- The number of possible shots depends on the remaining capacity of the card, image-recording quality, ISO speed, etc.
- Setting [**1: Release shutter without card**] to [**Disable**] will prevent you from shooting without a card inserted (p.256).

## Removing the Card

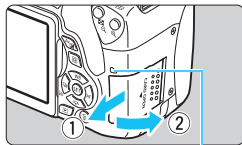

Access lamp

### 1 Open the cover.

- Set the power switch to <OFF>.
- **Make sure the access lamp is off, then open the cover.**
- If [Recording...] is displayed, close the cover.

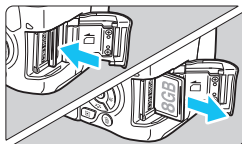

### 2 Remove the card.

- Gently push in the card, then let go to eject it.
- Pull the card straight out, then close the cover.

- **When the access lamp is lit or blinking, it indicates that images are being written to, read from, or erased from the card, or data is being transferred. Do not open the card slot cover during this time. Also, never do any of the following while the access lamp is lit or blinking. Otherwise, it can damage the image data, card, or camera.**
  - Removing the card.
  - Removing the battery.
  - Shaking or banging the camera around.
  - Unplugging and connecting a power cord (when the AC Adapter Kit is used).
- If the card already contains recorded images, the image number may not start from 0001 (p.261).
- If a card-related error message is displayed on the LCD monitor, remove and reinsert the card. If the error persists, use a different card. If you can transfer all the images on the card to a computer, transfer all the images and then format the card with the camera (p.59). The card may then return to normal.
- Do not touch the card's contacts with your fingers or metal objects. Do not expose the contacts to dust or water. If a smudge adheres to the contacts, contact failure may result.
- Multimedia cards (MMC) cannot be used (card error will be displayed).

# Using the LCD Monitor

After you flip out the LCD monitor, you can set menu functions, use Live View shooting, shoot movies, and play back images and movies. You can change the direction and angle of the LCD monitor.

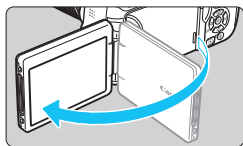

## 1 Flip out the LCD monitor.

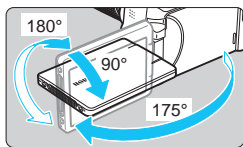

## 2 Rotate the LCD monitor.

- When the LCD monitor is swung out, you can rotate it up, down, or over 180° to face the subject.
- The indicated angle is only approximate.

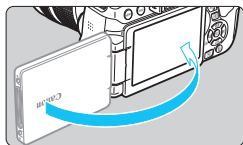

## 3 Face it toward you.

- Normally, use the camera with the LCD monitor facing you.



- Be careful not to force and break the hinge when rotating the LCD monitor.
- When Remote Switch RS-60E3 or an external microphone is connected to the camera, the rotation angle range of the flipped out LCD monitor will be limited.



- When not using the camera, close the LCD monitor with the screen facing inward. This will protect the screen.
- During Live View shooting or movie shooting, facing the LCD monitor toward the subject will display a mirror image on the screen.

# Turning on the Power

If you turn on the power switch and the date/time/zone setting screen appears, see page 42 to set the date/time/zone.

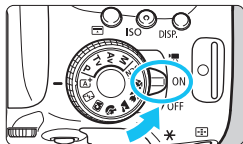

- < > : The camera turns on. You can shoot movies (p.222).
- < ON > : The camera turns on. You can shoot still photos.
- < OFF > : The camera is turned off and does not operate. Set to this position when not using the camera.

## Automatic Sensor Cleaning

- Whenever you set the power switch to <ON> or <OFF>, sensor cleaning will be executed automatically. (A small sound may be heard.) During the sensor cleaning, the LCD monitor will display < >.
- You can still shoot during sensor cleaning by pressing the shutter button halfway (p.50) to stop cleaning and take a picture.
- If you repeatedly turn the power switch <ON>/<OFF> at a short interval, the < > icon may not be displayed. This is normal and not a malfunction.

## **MENU** Auto Power Off

- To save battery power, the camera turns off automatically after approx. 30 seconds of non-operation. To turn on the camera again, just press the shutter button halfway (p.50).
- You can change the auto power off time with [**F2: Auto power off**] (p.257).





If you set the power switch to <OFF> while an image is being recorded to the card, [**Recording...**] will be displayed and the power will turn off after the recording finishes.



## Checking the Battery Level

When the power is turned on, the battery level will be indicated in one of the four levels.



-  : Battery level is sufficient.
-  : Battery level is low, but the camera can still be used.
-  : Battery will be exhausted soon. (Blinks)
-  : Recharge the battery.

## Number of Possible Shots (Approx. number of shots)

Temperature	Room Temperature (23°C / 73°F)	Low Temperatures (0°C / 32°F)
No Flash	550	470
50% Flash Use	440	400

- The figures above are based on a fully-charged Battery Pack LP-E17, no Live View shooting, and CIPA (Camera & Imaging Products Association) testing standards.
- Possible shots with Battery Grip BG-E18 (sold separately)
  - With LP-E17 x 2: approx, twice the shots without the battery grip.



- Doing any of the following will exhaust the battery sooner:
  - Pressing the shutter button halfway for a prolonged period.
  - Activating the AF frequently without taking a picture.
  - Using the lens Image Stabilizer.
  - Using the LCD monitor frequently.
- The number of possible shots may decrease depending on the actual shooting conditions.
- The lens operation is powered by the camera's battery. Depending on the lens used, the battery power may exhaust faster.
- For the number of possible shots with Live View shooting, see page 193.
- See [**f3: Battery info.**] to check the battery's condition (p.348).

## MENU Setting the Date, Time, and Zone

When you turn on the power for the first time or if the date/time/zone are reset, the date/time/zone setting screen will appear. Follow the steps below, making sure to set the time zone first. Set the camera to the time zone in which you currently live so that, when you travel, you can simply change the setting to the correct time zone for your destination, and the camera will automatically adjust the date/time.

**Note that the date/time appended to recorded images will be based on this date/time setting. Be sure to set the correct date/time.**

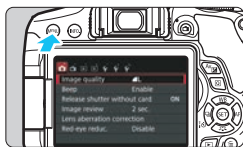

### 1 Display the menu screen.

- Press the <MENU> button to display the menu screen.

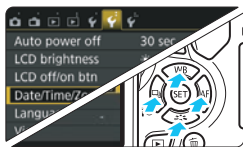

### 2 Under the [**2**] tab, select [Date/Time/Zone].

- Press the <◀><▶> keys to select the [**2**] tab.
- Press the <▲><▼> keys to select [Date/Time/Zone], then press <SET>.

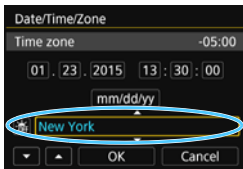

### 3 Set the time zone.

- [London] is set by default.
- Press the <◀><▶> keys to select the time zone box.
- Press <SET> so <⏏> is displayed.
- Press the <▲><▼> keys to select the time zone, then press <SET>.  
(Returns to <□>.)

- The menu setting procedure is explained on pages 54-55.
- In step 3, the time displayed on the upper right of the screen is the time difference compared with Coordinated Universal Time (UTC). If you do not see your time zone, set the time zone while referring to the difference with UTC.

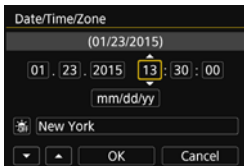

## 4 Set the date and time.

- Press the <◀> <▶> keys to select the number.
- Press <SET> so <⏸> is displayed.
- Press the <▲> <▼> keys to set the number, then press <SET>. (Returns to <□>.)

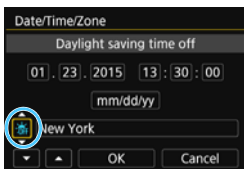

## 5 Set the daylight saving time.

- Set it if necessary.
- Press the <◀> <▶> keys to select [☀️].
- Press <SET> so <⏸> is displayed.
- Press the <▲> <▼> keys to select [☀️], then press <SET>.
- When the daylight saving time is set to [☀️], the time set in step 4 will advance by 1 hour. If [☀️] is set, the daylight saving time will be canceled and the time will go back by 1 hour.

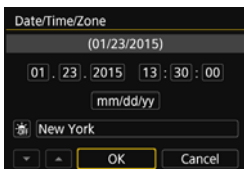

## 6 Exit the setting.

- Press the <◀> <▶> keys to select [OK], then press <SET>.
- ▶ The date/time/zone and daylight saving time will be set and the menu will reappear.



The date/time/zone settings may be reset in the following cases. If this happens, set the date/time/zone again.

- When the camera is stored without the battery.
- When the camera's battery becomes exhausted.
- When the camera is exposed to below freezing temperatures for a prolonged period.



- The date/time that were set will start when you select [OK] in step 6.
- After changing the time zone, check that the correct date and time are set.

## MENU Selecting the Interface Language

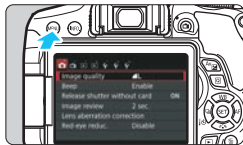

- 1 **Display the menu screen.**
  - Press the <MENU> button to display the menu screen.



- 2 **Under the [**F2**] tab, select [Language].**
  - Press the <◀> <▶> keys to select the [**F2**] tab.
  - Press the <▲> <▼> keys to select [Language], then press <SET>.

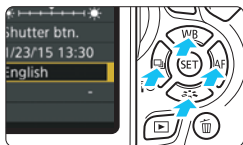

- 3 **Set the desired language.**
  - Press the <▲> <▼> keys to select the language, then press <SET>.
  - ▶ The interface language will change.

# Attaching and Detaching a Lens

The camera is compatible with all Canon EF and EF-S lenses. **The camera cannot be used with EF-M lenses.**

## Attaching a Lens

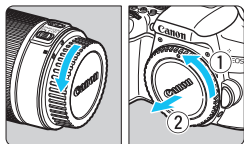

### 1 Remove the caps.

- Remove the rear lens cap and the body cap by turning them as shown by the arrows.

White index

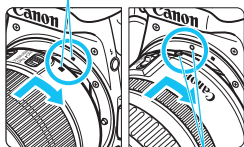

### 2 Attach the lens.

- Align the lens's red or white index with the camera's index matching the same color. Turn the lens as shown by the arrow until it clicks in place.

Red index

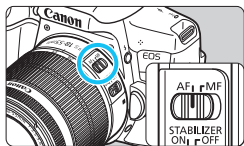

### 3 Set the lens's focus mode switch to <AF>.

- <AF> stands for autofocus.
- <MF> stands for manual focus.

### 4 Remove the front lens cap.

#### Minimizing Dust

- When changing lenses, do it quickly in a place with minimal dust.
- When storing the camera without a lens attached, be sure to attach the body cap to the camera.
- Remove dust on the body cap before attaching it.

## Zooming

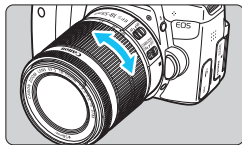

**Turn the zoom ring on the lens with your fingers.**

- If you want to zoom, do it before focusing. Turning the zoom ring after achieving focus may throw off the focus.

## Detaching the Lens

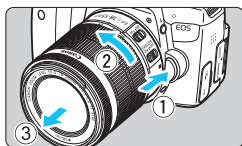

**While pressing the lens release button, turn the lens as shown by the arrow.**

- Turn the lens until it stops, then detach it.
- Attach the rear lens cap to the detached lens.

### ● To owners of the EF-S18-135mm f/3.5-5.6 IS STM lens:

You can prevent the lens from extending out while you are carrying it around. Set the zoom ring to the 18mm wide-angle end, then slide the zoom ring lock lever to <LOCK>. The zoom ring can be locked only at the wide-angle end.

- Do not look at the sun directly through any lens. Doing so may cause loss of vision.
- When attaching or detaching a lens, set the camera's power switch to <OFF>.
- If the front part (focusing ring) of the lens rotates during autofocus, do not touch the rotating part.
- If you purchased a lens kit with the EF-S18-55mm f/3.5-5.6 IS STM lens, EF-S18-135mm f/3.5-5.6 IS STM lens, or EF-S55-250mm f/4-5.6 IS STM lens, see "Handling Precautions" on page 383.



## Angle of View

Since the image sensor size is smaller than the 35mm film format, the angle of view of an attached lens will be equivalent to that of a lens with approx. 1.6x of the focal length indicated.

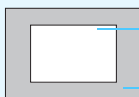
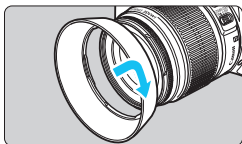

Image sensor size (Approx.)  
(22.3 x 14.9 mm /  
0.88 x 0.59 in.)  
35mm image size  
(36 x 24 mm /  
1.42 x 0.94 in.)

## Attaching a Lens Hood

A lens hood can block unwanted light and prevent rain, snow, dust, etc. adhering to the front of the lens. When storing the lens in a bag, etc., you can also attach the hood in reverse.

- If there is no index mark on the lens and hood:



### Attach the lens hood.

- Turn the hood as shown by the arrow to attach it securely.

- If there is an index mark on the lens and hood:

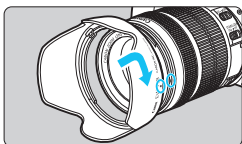

- 1 Align the red dots on the hood and lens edges, then turn the hood as shown by the arrow.

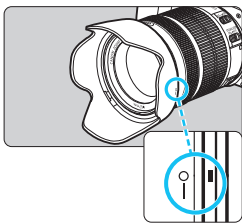

- 2 Turn the hood as shown in the illustration.

- Turn the hood clockwise until it attaches securely.



- If the hood is not attached properly, it may obstruct the image's periphery, making the image look dark.
- When attaching or detaching the hood, grasp the base of the hood to turn it. Grasping the hood's edges to turn it may deform the hood, resulting in failure to turn.
- When using the camera's built-in flash, detach the hood. Otherwise, the hood will obstruct part of the flash.

# Lens Image Stabilizer

When you use the IS lens's built-in Image Stabilizer, camera shake is corrected to obtain a sharper shot. The procedure explained here is based on the EF-S18-55mm f/3.5-5.6 IS STM lens as an example.

\* IS stands for Image Stabilizer.

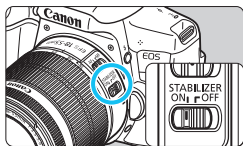

- 1 Set the IS switch to <ON>.**
  - Set also the camera's power switch to <ON>.
- 2 Press the shutter button halfway.**
  - ▶ The Image Stabilizer will operate.
- 3 Take the picture.**
  - When the picture looks steady in the viewfinder, press the shutter button completely to take the picture.

- The Image Stabilizer will not be effective if the subject moves during the exposure.
- For bulb exposures, set the IS switch to <OFF>. If <ON> is set, Image Stabilizer misoperation may occur.
- The Image Stabilizer may not be effective for excessive shaking such as on a rocking boat.

- The Image Stabilizer can operate with the lens's focus mode switch set to either <AF> or <MF>.
- When using a tripod, you can still shoot with the IS switch set to <ON> with no problem. However, to save battery power, setting the IS switch to <OFF> is recommended.
- The Image Stabilizer is effective even when the camera is mounted on a monopod.
- With the EF-S18-55mm f/3.5-5.6 IS STM lens, EF-S18-135mm f/3.5-5.6 IS STM lens, or EF-S55-250mm f/4-5.6 IS STM lens, the Image Stabilizer mode will be switched automatically to suit the shooting conditions.



# Basic Operation

## Adjusting the Viewfinder Clarity

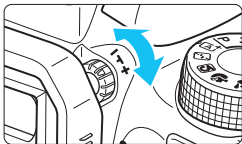

### Turn the dioptic adjustment knob.

- Turn the knob left or right so that the AF points in the viewfinder look the sharpest.



If the camera dioptic adjustment still cannot provide a sharp viewfinder image, using E-series Dioptic Adjustment Lenses (sold separately) is recommended.

## Holding the Camera

To obtain sharp images, hold the camera still to minimize camera shake.

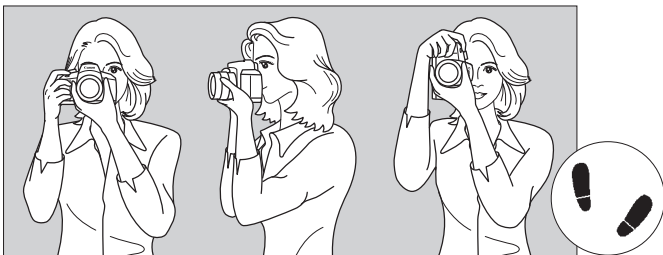

Horizontal shooting

Vertical shooting

1. Wrap your right hand around the camera grip firmly.
2. Hold the lens bottom with your left hand.
3. Rest your hand's right index finger lightly on the shutter button.
4. Press your arms and elbows lightly against the front of your body.
5. To maintain a stable stance, place one foot slightly ahead of the other.
6. Press the camera against your face and look through the viewfinder.



To shoot while looking at the LCD monitor, see page 191.

## Shutter Button

The shutter button has two steps. You can press the shutter button halfway. Then you can further press the shutter button completely.

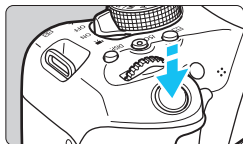

### Pressing Halfway

This activates autofocus and the automatic exposure system that sets the shutter speed and aperture.

The exposure setting (shutter speed and aperture) is displayed in the viewfinder (⦿4).

While you are pressing the shutter button halfway, the LCD monitor is turned off (p.270).

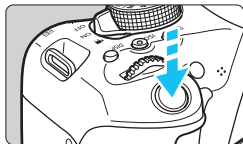

### Pressing Completely

This releases the shutter and takes the picture.

## Preventing Camera Shake

Hand-held camera movement during the moment of exposure is called camera shake. It can cause blurred pictures. To prevent camera shake, note the following:

- Hold and steady the camera as shown on the preceding page.
- Press the shutter button halfway to autofocus, then slowly press the shutter button completely.



- If you press the shutter button completely without pressing it halfway first, or if you press the shutter button halfway and then press it completely immediately, the camera will take a moment before it takes the picture.
- Even during menu display, image playback, or image recording, you can instantly go back to shooting-ready by pressing the shutter button halfway.

## Q Quick Control for Shooting Functions

You can directly select and set the shooting functions displayed on the LCD monitor. This is called Quick Control.

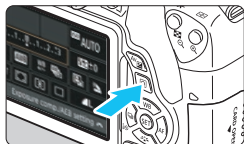

### 1 Press the <Q> button (10).

- ▶ The Quick Control screen will appear.



### 2 Set the desired functions.

- Press the <+> cross keys to select a function.
- ▶ The selected function and Feature guide (p.64) will appear.
- Turn the <DIAL> dial to change the setting.

#### Basic Zone modes

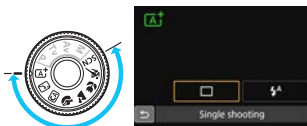

#### Creative Zone modes



### 3 Take the picture.

- Press the shutter button completely to take the picture.
- ▶ The captured image will be displayed.



- For the functions settable in Basic Zone modes and their setting procedures, see page 89.
- In steps 1 and 2, you can also use the LCD monitor's touch screen (p.56).

## Sample Quick Control Screen

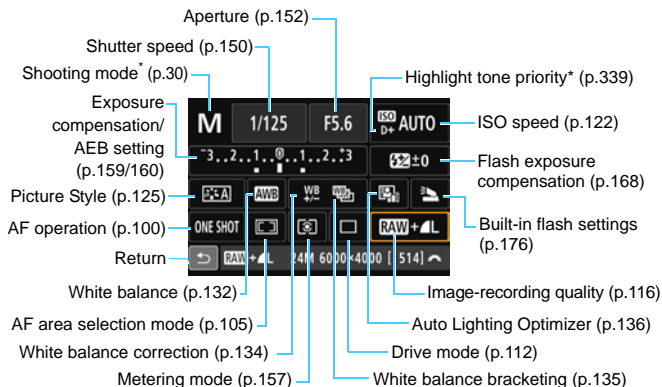

\* Functions marked with an asterisk cannot be set with the Quick Control screen.

## Function Setting Screen



↓ <SET>

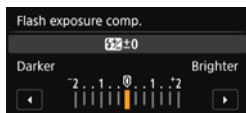

- Select the desired function and press <SET>. The function's setting screen will appear.
- Press the <◀> <▶> keys or turn the <☺> dial to change the settings. There are also some functions that are set by pressing the <INFO.>, <☰>, or <☒> button.
- Press <SET> to finalize the setting and return to the Quick Control screen.
- When you select <☐> (p.104) and press the <MENU> button, the previous screen will reappear.

## MENU Menu Operations

You can set various settings with the menus such as the image-recording quality, date and time, etc.

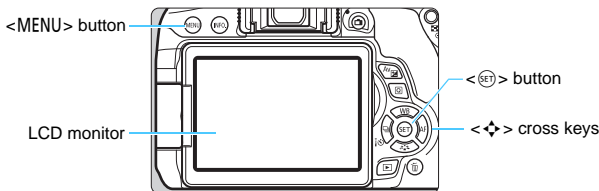

### Menu Screen

The menu tabs and items displayed will differ depending on the shooting mode.

#### Basic Zone modes

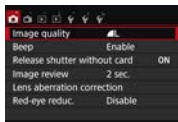

#### Movie shooting

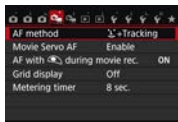
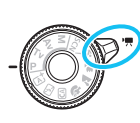

#### Creative Zone modes

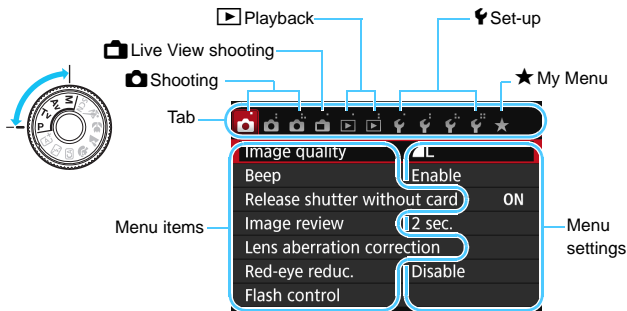

## Menu Setting Procedure

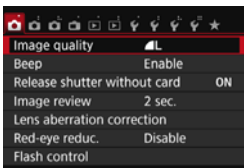

### 1 Display the menu screen.

- Press the <MENU> button to display the menu screen.

### 2 Select a tab.

- Press the <◀> <▶> keys of the cross keys to select a tab (group of functions).
- For example, in this manual, “the [📷3] tab” refers to the screen displayed when the third 📷 (Shooting) tab from the left [📷+] is selected.

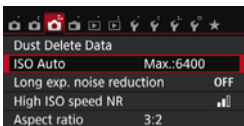

### 3 Select the desired item.

- Press the <▲> <▼> keys of the cross keys to select the item, then press <SET>.

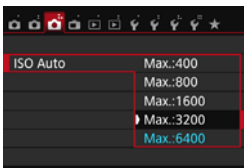

### 4 Select the setting.

- Press the <▲> <▼> or <◀> <▶> keys of the cross keys to select the desired setting. (Some settings require you to press either the <▲> <▼> or <◀> <▶> keys to select those settings.)
- The current setting is indicated in blue.

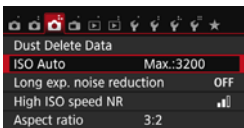

### 5 Set the desired setting.

- Press <SET> to set it.

### 6 Exit the setting.

- Press the <MENU> button to return to the shooting function settings display.



- In step 2, you can also turn the <  > dial to select a menu tab.
- In steps 2 to 5, you can also use the LCD monitor's touch screen (p.56).
- The explanation of menu functions hereinafter assumes that you have pressed the <MENU> button to display the menu screen.
- To cancel, press the <MENU> button.
- For details about each menu item, see page 362.

## Dimmed Menu Items

Example: When [Multi Shot Noise Reduction] is set

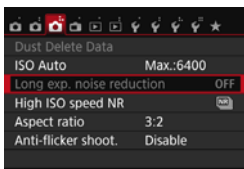

Dimmed menu items cannot be set. The menu item is dimmed if another function setting is overriding it.

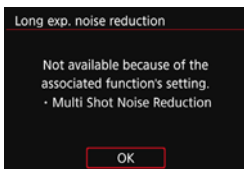

You can see the overriding function by selecting the dimmed menu item and pressing <  >.

If you cancel the overriding function's setting, the dimmed menu item will become settable.



Some dimmed menu items will not show the overriding function.



With [Clear all camera settings] under [**4: Clear settings**], you can reset the menu functions to the default settings (p.267).

## Using the Touch Screen

The LCD monitor is a touch-sensitive panel that you can operate with your fingers.

### Tap

#### Quick Control (Sample display)



- Use your finger to tap on (touch briefly and then remove your finger from) the LCD monitor.
- By tapping, you can select menus, icons, etc., displayed on the LCD monitor.
- When touch-screen operation is possible, a frame will appear around the icon (except on menu screens). For example, when you tap on [Q], the Quick Control screen appears. By tapping on [↶], you can return to the preceding screen.



#### Operations possible by tapping on the screen

- Setting menu functions after pressing the <MENU> button
- Quick Control
- Setting functions after pressing the <[Q]>, <ISO>, <[Q]>, <▲WB>, <▼[WB]>, <◀[WB]>, or <▶AF> button
- Touch shutter during Live View shooting
- Setting functions during Live View shooting
- Setting functions during movie shooting
- Playback operations



## Drag

### Menu screen (Sample display)



- Slide your finger while touching the LCD monitor.

### Scale display (Sample display)

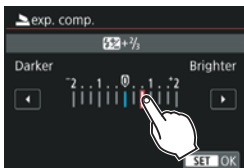

### Operations possible by dragging your finger on the screen

- Selecting a menu tab or item after pressing the <MENU> button
- Setting a scale control
- Quick Control
- Setting functions during Live View shooting
- Setting functions during movie shooting
- Playback operations

## **MENU** Silencing the Beep during Touch Operations

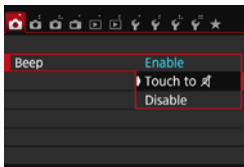

If [**1: Beep**] is set to [Touch to , the beep will not sound during touch operations.

## MENU Touch Control Settings

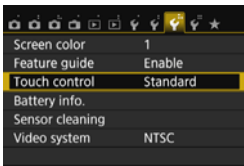

### 1 Select [Touch control].

- Under the [**3**] tab, select [**Touch control**], then press <SET>.

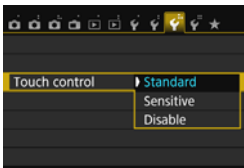

### 2 Set the touch control setting.

- Select the preferred setting, then press <SET>.
- [**Standard**] is the normal setting.
- [**Sensitive**] provides a more reactive touch response than [**Standard**]. Try using both settings and select the one you prefer.
- To disable touch-screen operations, select [**Disable**].

## ⚠ Cautions for Touch Screen Operations

- Since the LCD monitor is not pressure sensitive, do not use any sharp objects, such as your fingernail or a ballpoint pen, for touch operations.
- Do not use wet fingers for touch screen operations.
- If the LCD monitor has any moisture or if your fingers are wet, the touch screen may not respond or misoperation may occur. In such a case, turn off the power and wipe the LCD monitor with a cloth.
- Do not attach any protective sheet (commercially available) or sticker on the LCD monitor. It may make the touch operation response slow.
- If you quickly perform touch operation when [**Sensitive**] is set, the touch response may be slower.

## MENU Formatting the Card

If the card is new or was previously formatted by another camera or computer, format the card with this camera.

- ⚠ **When the card is formatted, all images and data on the card will be erased. Even protected images will be erased, so make sure there is nothing you need to keep. If necessary, transfer the images and data to a computer, etc., before formatting the card.**

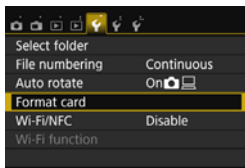

### 1 Select [Format card].

- Under the [**F1**] tab, select [**Format card**], then press <SET>.

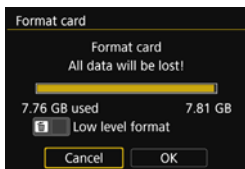

### 2 Format the card.

- Select [**OK**], then press <SET>.
- ▶ The card will be formatted.
- ▶ When the formatting is completed, the menu will reappear.

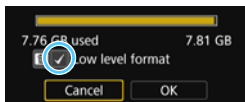

- For low-level formatting, press the <trash> button to append [**Low level format**] with a checkmark <✓>, then select [**OK**].



## Execute [Format card] in the following cases:

- The card is new.
- The card was formatted by a different camera or a computer.
- The card is full with images or data.
- A card-related error is displayed (p.382).

### Low-level Formatting

- Perform low-level formatting if the card's recording or reading speed seems slow or if you want to totally erase data on the card.
- Since low-level formatting will format all recordable sectors on the card, the formatting will take slightly longer than normal formatting.
- You can stop the low-level formatting by selecting [**Cancel**]. Even in this case, normal formatting will be completed and you can use the card as usual.

- When the card is formatted or data is erased, only the file management information is changed. The actual data is not completely erased. Be aware of this when selling or discarding the card. When discarding the card, execute low-level formatting or destroy the card physically to prevent the personal data from being leaked.
- **Before using a new Eye-Fi card, the software on the card must be installed on your computer. Then format the card with the camera.**



- The card capacity displayed on the card format screen may be smaller than the capacity indicated on the card.
- This device incorporates exFAT technology licensed from Microsoft.

# Switching the LCD Monitor Display

The LCD monitor can display the shooting settings screen, menu screen, captured images, etc.

## Shooting Settings

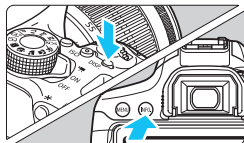
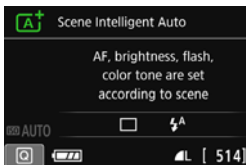

- When you turn on the power, the shooting settings will be displayed.
- **When you press the shutter button halfway, the display will turn off. And when you let go of the shutter button, the display will turn on.**
- You can also turn off the display by pressing the <DISP.> button. Press the button again to turn on the display.
- By pressing the <INFO.> button, you can toggle the LCD monitor display between the shooting settings (p.28) and the camera settings (p.266).

## Menu Functions

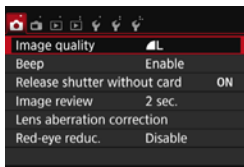

- Appears when you press the <MENU> button. Press the button again to return to the shooting settings screen.

## Captured Image



- Appears when you press the <▶> button. Press the button again to return to the shooting settings screen.



- You can set [**⚡: LCD off/on btn**] so that the LCD monitor does not turn off and on (p.270).
- Even when the menu screen or captured image is displayed, pressing the shutter button will enable you to shoot immediately.

## ⚡ Displaying the Grid

You can display a grid in the viewfinder to help you check the camera tilt or compose the shot.

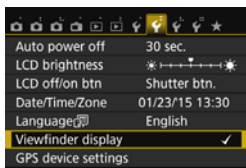

### 1 Select [Viewfinder display].

- Under the [**2**] tab, select [**Viewfinder display**], then press <SET>.

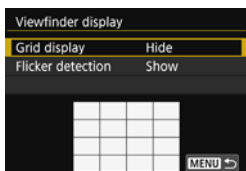

### 2 Select [Grid display].

- Select [**Grid display**], then press <SET>.

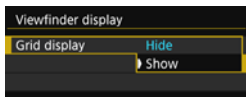

### 3 Select [Show].

- Select [**Show**], then press <SET>.
- ▶ When you exit the menu, the grid will appear in the viewfinder.

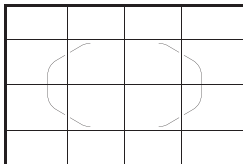

 You can display a grid on the LCD monitor during Live View shooting and before you start shooting a movie (p.204, 250).

# Displaying the Flicker Detection ☆

If you set this function, < **Flicker!** > will appear in the viewfinder when the camera detects flicker caused by the blinking of the light source. By default, flicker detection is set to [Show].



## 1 Select [Viewfinder display].

- Under the [F2] tab, select [Viewfinder display], then press < (SET) >.



## 2 Select [Flicker detection].

- Select [Flicker detection], then press < (SET) >.



## 3 Select [Show].

- Select [Show], then press < (SET) >.



If you set [**3: Anti-flicker shoot.**] to [Enable], you can shoot with reduced unevenness of exposure caused by the flicker (p.144).

## Feature Guide

The Feature guide appears when you change the shooting mode or set a shooting function, Live View shooting, movie shooting, or Quick Control for playback, and displays a brief description of that mode, function or option. It also displays a description when you select a function or option on the Quick Control screen. The Feature guide turns off when you tap on the description or proceed with the operation.

### ● Shooting mode (Sample)

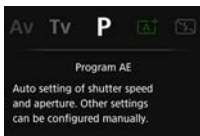
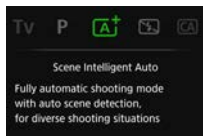

### ● Quick Control (Sample)



Shooting settings



Live View shooting



Playback

## **MENU** Disabling the Feature Guide

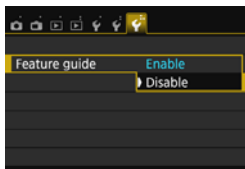

### Select [Feature guide].

- Under the [**F3**] tab, select [**Feature guide**], then press <SET>.
- Select [**Disable**], then press <SET>.





# 2

## Basic Shooting and Image Playback

This chapter explains how to use the Basic Zone modes on the Mode Dial for best results and how to play back images.

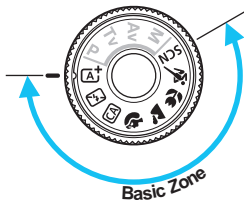
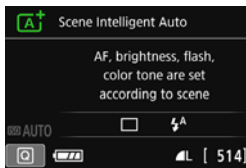
With Basic Zone modes, all you do is point and shoot while the camera sets everything automatically (p.89, 354). Also, to prevent botched pictures due to mistaken operations, advanced shooting function settings cannot be changed.



 If you set the Mode Dial to <SCN> when the LCD monitor is off, press the <Q> button to check the shooting mode before shooting (p.80).

## **[A+]** Fully Automatic Shooting (Scene Intelligent Auto) ■

**<[A+]>** is a fully automatic mode. The camera analyzes the scene and sets the optimum settings automatically. It also adjusts focus automatically by detecting whether the subject is still or moving (p.69).

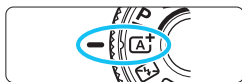

**1 Set the Mode Dial to <[A+]>.**

Area AF frame

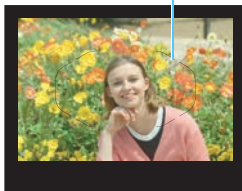

**2 Aim the Area AF frame over the subject.**

- All the AF points will be used to focus, and the camera will focus on the closest object.
- Aiming the center of the Area AF frame over the subject will make focusing easier.

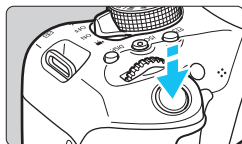

**3 Focus on the subject.**

- Press the shutter button halfway. The lens focusing ring will rotate to focus.
- ▶ The AF point(s) that achieve(s) focus will be displayed. At the same time, the beeper will sound and the focus indicator **<●>** in the viewfinder will light up.
- ▶ In low light, the AF point(s) will light up briefly in red.
- ▶ If necessary, the built-in flash will be raised automatically.

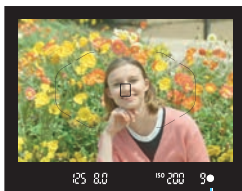

Focus indicator

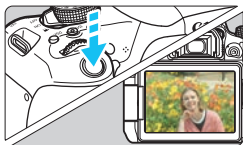

## 4 Take the picture.

- Press the shutter button completely to take the picture.
- ▶ The captured image will be displayed for 2 sec. on the LCD monitor.
- After you finish shooting, push down the built-in flash with your fingers.



The **<A+>** mode makes the colors look more impressive in nature, outdoor, and sunset scenes. If you did not obtain the desired color tones, change the mode to a Creative Zone mode and select a Picture Style other than **<P-A>**, then shoot again (p.125).



## FAQ

- **The focus indicator <●> blinks and focus is not achieved.**  
Aim the Area AF frame over an area with good contrast, then press the shutter button halfway (p.50). If you are too close to the subject, move away and try again.
- **When focus is achieved, the AF points do not light up in red.**  
The AF points light up in red only when focus is achieved in low-light conditions.
- **Multiple AF points light up simultaneously.**  
Focus has been achieved at all those points. You can take the picture as long as an AF point covering the target subject is lighting up.

- **The beeper continues to beep softly. (The focus indicator <●> does not light up.)**



It indicates that the camera is focusing continuously on a moving subject. (The focus indicator <●> does not light up.) You can take sharp pictures of a moving subject.

Note that the focus lock (p.69) will not work in this case.

- **Pressing the shutter button halfway does not focus on the subject.**

If the focus mode switch on the lens is set to <MF> (manual focus), set it to <AF> (autofocus).

- **The flash fired even though it was daylight.**

For a backlit subject, the flash may fire to help lighten the subject's dark areas. If you do not want the flash to fire, use the Quick Control to set [Flash firing] to [> (p.88) or set the <> (Flash Off) mode and shoot (p.71).

- **The flash fired and the picture came out extremely bright.**

Move further from the subject and shoot. When shooting flash photography, if the subject is too close to the camera, the picture may come out extremely bright (overexposure).

- **In low light, the built-in flash fired a series of flashes.**

Pressing the shutter button halfway may trigger the built-in flash to fire a series of flashes to assist autofocusing. This is called the AF-assist beam. Its effective range is approx. 4 meters/13.1 feet. The built-in flash will make a sound when firing continuously. This is normal and not a malfunction.

- **When flash was used, the bottom part of the picture came out unnaturally dark.**

The shadow of the lens barrel was captured in the picture because the subject was too close to the camera. Move further away from the subject and shoot. If a hood is attached to the lens, remove it before taking the flash picture.

## Full Auto Techniques (Scene Intelligent Auto) ■

### Recomposing the Shot



Depending on the scene, position the subject toward the left or right to create a balanced background and good perspective.

In the  $\langle \text{AF}^+ \rangle$  mode, pressing the shutter button halfway to focus on a still subject will lock the focus on that subject. Recompose the shot while keeping the shutter button pressed halfway, and then press the shutter button completely to take the picture. This is called “focus lock”. Focus lock is also possible in other Basic Zone modes (except  $\langle \text{AF-L} \rangle$  and  $\langle \text{AF-ON} \rangle$ ).

### Shooting a Moving Subject



In the  $\langle \text{AF}^+ \rangle$  mode, if the subject moves (distance to camera changes) while or after you focus, AI Servo AF will take effect to focus on the subject continuously. (The beeper will continue beeping softly.) As long as you keep the Area AF frame positioned over the subject while pressing the shutter button halfway, the focusing will be continuous. When you want to take the picture, press the shutter button completely.

## Live View Shooting

You can shoot while viewing the image on the LCD monitor. This is called “Live View shooting”. For details, see page 191.

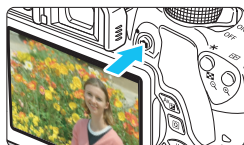

### 1 Display the Live View image on the LCD monitor.

- Press the <img alt="camera icon" data-bbox="598 251 628 271"/> button.
- ▶ The Live View image will appear on the LCD monitor.



### 2 Focus on the subject.

- Press the shutter button halfway to focus.
- ▶ When focus is achieved, the AF point will turn green and the beeper will sound.

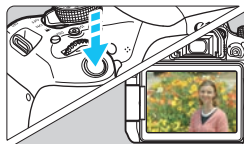

### 3 Take the picture.

- Press the shutter button completely.
- ▶ The picture is taken and the captured image is displayed on the LCD monitor.
- ▶ When the playback display ends, the camera will return to Live View shooting automatically.
- Press the <img alt="camera icon" data-bbox="598 691 628 711"/> button to end the Live View shooting.

You can also rotate the LCD monitor for different angles (p.39).



Normal angle



Low angle



High angle

## Disabling Flash

The camera analyzes the scene and sets the optimum settings automatically. In places where flash photography is prohibited such as in a museum or an aquarium, use the <> (Flash Off) mode.

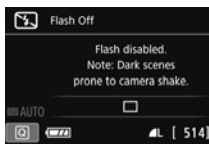
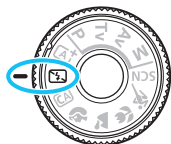

## Shooting Tips

- **Prevent camera shake if the numeric display in the viewfinder blinks.**

Under low light when camera shake is prone to occur, the viewfinder's shutter speed display will blink. Hold the camera steady or use a tripod. When using a zoom lens, use the wide-angle end to reduce blur caused by camera shake even while handholding the camera.

- **Take portraits without flash.**

In low-light conditions, tell the subject to keep still until the picture is taken. Any movement by the subject during shooting may result in the subject being blurred in the picture.

## CA Creative Auto Shooting

In the <CA> mode, you can set the following functions for shooting: (1) Extra Effect Shot, (2) Ambience-based shots, (3) Background blur, (4) Drive mode, and (5) Flash firing. The default settings are the same as the <A+> mode.

\* CA stands for Creative Auto.



### 1 Set the Mode Dial to <CA>.

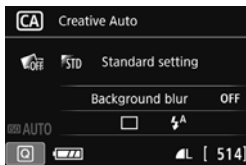

### 2 Press the <Q> button (10).

▶ The Quick Control screen will appear.

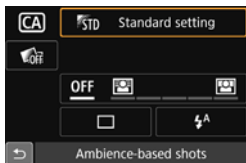

### 3 Set the desired function.

- Press the <⬆> cross keys to select a function.
- ▶ The selected function and Feature guide (p.64) will appear.
- Press <SET> to set the function.
- For the setting procedure and details on each function, see pages 73-75.

### 4 Take the picture.

- Press the shutter button completely to take the picture.



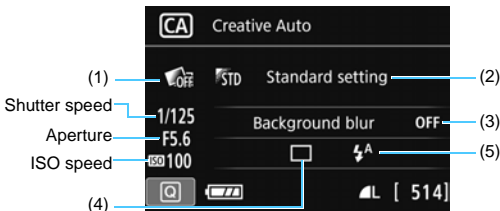

If you set (1), (2) or (3) when the camera is set for Live View shooting, you can see the effect on the screen before you start shooting.

### (1) Extra Effect Shot

- You can select any of the following effects for shooting: Creative filters (p.200), Picture Styles (p.125), and Ambience-based shots (p.90).
- Press the <◀> <▶> keys to select [ : Enable]. Turn the <☀> dial to select a shooting effect and shoot.
- When you take a picture, two images will be recorded. One with the effect applied and one without. Both images will be displayed together immediately after you take the picture. The image without the effect is displayed on the left and the one with the effect on the right.

### Registering your favorite shooting effects

- During the image review immediately after shooting and during playback, the image applied with the effect will have the [SET ] icon. After you press the <SET> button and then the <INFO.> button, you can check which shooting effect is applied.
- You can register up to two shooting effects under [★ :Favorite effect].
- When you select the registered [★ :Favorite effect], you can shoot with that shooting effect applied. You can also overwrite the [★ :Favorite effect].



- If you are using an Eye-Fi card and have set it to erase images after their transfer, the image without the effect will not be displayed during the playback immediately after shooting.
- The Live View image displayed with Extra Effect Shot applied will not look exactly the same as the actual photo.

## (2) Ambience-based shots

- You can select and shoot with the ambience you want to convey in your images.
- Press the <▲> <▼> keys to select the ambience. For details, see page 90.

## (3) Background blur



- If [OFF] is set, the degree of background blur will change depending on the brightness.
- If it is set to any setting other than [OFF], you can adjust the background blur regardless of the brightness.
- If you turn the <☺> dial to move the cursor to the right, the background will look sharper.
- Turning the <☺> dial to move the cursor to the left will blur the subject's background. Note that depending on the lens's maximum aperture (smallest f/number), certain slider adjustments may not be selectable.
- If you use Live View shooting, you can see how the image is blurred in front of and behind the point of focus. When you turn the <☺> dial, [Simulating blur] will be displayed on the LCD monitor.
- If you want to blur the background, see "Shooting Portraits" on page 76.
- Depending on the lens and shooting conditions, the background may not look so blurred.
- This function cannot be set if you use flash. If <⚡> has been set and you set background blur, <Ⓢ> will be set automatically.



- If [Simulating blur] is effective during Live View shooting, the image displayed with <Exp.SIM> (p.194) blinking may have more noise than the actual image being recorded, or it may look dark.
- You cannot set both (1) Extra Effect Shot and (2) Ambience-based shots at the same time.
- You cannot set both (1) Extra Effect Shot and (3) Background blur at the same time.

(4) **Drive mode:** Use the  dial to make the selection.

<□> **Single shooting:**

Shoot one image at a time.

<□> **Continuous shooting:**

While you hold down the shutter button completely, shots will be taken continuously. You can shoot up to approx. 5.0 shots per second.

<□S> **Silent single shooting\*:**

Single shooting with less shooting sound than <□>.

<□S> **Silent continuous shooting\*:**

Continuous shooting (max. approx. 3.0 shots per second) with less shooting sound than <□>.

<⌚> **Self-timer: 10sec./remote control:**

The picture is taken 10 seconds after you press the shutter button. A remote controller can also be used.

<⌚2> **Self-timer: 2 sec.:**

The picture is taken 2 seconds after you press the shutter button.

<⌚C> **Self-timer: Continuous:**

Press the <▲> <▼> keys to set the number of multiple shots (2 to 10) to be taken with the self-timer. 10 seconds after you press the shutter button, the set number of multiple shots will be taken.

\* Cannot be set during Live View shooting.

(5) **Flash firing:** Turn the  dial to select the desired setting.

<⚡> **Auto flash** : The flash fires automatically when necessary.

<⚡> **Flash on** : The flash fires at all times.

<⊕> **Flash off** : The flash is disabled.



- When using the self-timer, see the  notes on page 114.
- When using <⊕>, see “Disabling Flash” on page 71.
- If you have set Extra Effect Shot, **RAW** + **L**, **RAW**, and <□> <□S> <⌚C> cannot be set.
- If you have set background blur, you cannot use flash.

## Shooting Portraits

The <img alt="Portrait mode icon" data-bbox="128 91 153 116"/> (Portrait) mode blurs the background to make the human subject stand out. It also makes skin tones and hair look softer.

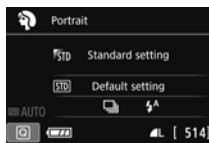
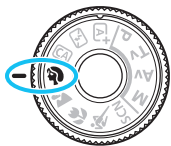

### Shooting Tips

- **Select the location where the distance between the subject and the background is the farthest.**

The further the distance between the subject and background, the more blurred the background will look. The subject will also stand out better against an uncluttered dark background.

- **Use a telephoto lens.**

If you have a zoom lens, use the telephoto end to fill the frame with the subject from the waist up. Move in closer if necessary.

- **Focus on the face.**

Check that the AF point covering the face lights up. For close-ups of the face, focus on the eyes.

 The default setting is <img alt="Continuous shooting icon" data-bbox="128 881 153 906"/> (Continuous shooting). If you hold down the shutter button, you can shoot continuously to capture subtle changes in the subject's pose and facial expression (max. approx. 5.0 shots/sec.).

## Shooting Landscapes

Use the <> (Landscape) mode for wide scenery or to have everything in focus from near to far. For vivid blues and greens, and very sharp and crisp images.

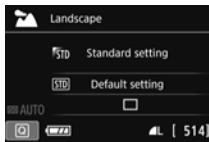
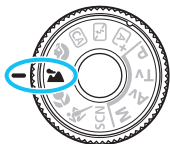

### Shooting Tips

- **With a zoom lens, use the wide-angle end.**

When using the wide-angle end of a zoom lens, objects near and far will be in focus better than at the telephoto end. It also adds breadth to landscapes.

- **Shooting night scenes.**

The <> mode is also good for night scenes because it disables the built-in flash. When shooting night scenes, use a tripod to prevent camera shake.



- The built-in flash will not fire even in backlit or low-light conditions.
- If you are using an external Speedlite, the Speedlite will fire.

## Shooting Close-ups

When you want to shoot flowers or small things up close, use the <> (Close-up) mode. To make small things appear much larger, use a macro lens (sold separately).

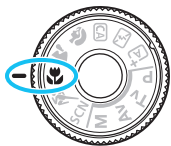



## Shooting Tips

- **Use a simple background.**

A simple background makes small objects such as flowers stand out better.

- **Move in as close as possible to the subject.**

Check the lens for its minimum focusing distance. Some lenses have indications such as <MACRO 0.25m/0.8ft> on them. The lens minimum focusing distance is measured from the <> (focal plane) mark on the top of the camera to the subject. If you are too close to the subject, the focus indicator <> will blink.

If you use flash and the bottom of the picture looks unusually dark, move away from the subject.

- **With a zoom lens, use the telephoto end.**

If you have a zoom lens, using the telephoto end will make the subject look larger.

## Shooting Moving Subjects

Use the < > (Sports) mode to shoot a moving subject, such as a running person or a moving vehicle.

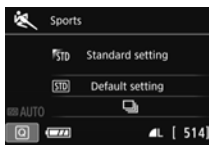



### Shooting Tips

- **Use a telephoto lens.**

The use of a telephoto lens is recommended for shooting from a distance.

- **Track the subject with the Area AF frame.**

Aim the center AF point over the subject, then press the shutter button halfway to start autofocusing in Area AF frame. During autofocusing, the beeper will continue beeping softly. If focus cannot be achieved, the focus indicator < > will blink.

The default setting is < > (Continuous shooting). When you want to take the picture, press the shutter button completely. If you hold down the shutter button, you will be able to maintain autofocusing during continuous shooting of the subject's movement (max. approx. 5.0 shots per sec.).



- Under low light when camera shake is prone to occur, the viewfinder's shutter speed display on the bottom left will blink. Hold the camera steady and shoot.
- During Live View shooting, One-Shot AF will apply (p.101).
- If you are using an external Speedlite, the Speedlite will fire.

# SCN: Special Scene Mode

The camera will automatically choose the appropriate settings when you select a shooting mode for your subject or scene.



**1 Set the Mode Dial to <SCN>.**



**2 Press the <Q> button (10).**  
▶ The Quick Control screen will appear.

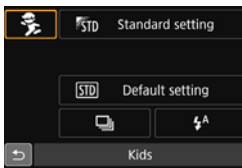

**3 Select a shooting mode.**

- Press the <+> cross keys to select the desired shooting mode's icon.
- Turn the <G> dial to select a shooting mode.
- You can also select the shooting mode icon and press <SET> to display a selection of shooting modes from which you can select one.



## Available Shooting Modes in the <SCN> Mode

Shooting Mode	Page
Kids	p.81
Food	p.82
Candlelight	p.83

Shooting Mode	Page
Night Portrait	p.84
Handheld Night Scene	p.85
HDR Backlight Control	p.86



## Shooting Children

When you want to continuously focus and shoot children running around, use  (Kids). Skin tones will look healthy.



### Shooting Tips

- **Track the subject with the Area AF frame.**

Aim the center AF point over the subject, then press the shutter button halfway to start autofocusing in Area AF frame. During autofocusing, the beeper will continue beeping softly. If focus cannot be achieved, the focus indicator  will blink.

- **Shoot continuously.**

The default setting is  (Continuous shooting). When you want to take the picture, press the shutter button completely. If you hold down the shutter button, you will be able to maintain autofocusing during continuous shooting of the subject's changing facial expressions and movement (max. approx. 5.0 shots per sec.).



- While the flash is recycling, "**buSY**" is displayed in the viewfinder, and a picture cannot be taken. Take the picture after this display turns off. During Live View shooting, "**BUSY**" is displayed on the LCD monitor, and you cannot view the subject.
- During Live View shooting, One-Shot AF will apply (p.101).

## 🍴 Shooting Food

When shooting food, use <🍴> (Food). The photo will look bright and vivid.



### Shooting Tips

- **Change the color tone.**

You can change [Color tone]. Food photos with a reddish tinge usually make the food look more vivid. To increase the food's reddish tinge, set it toward [Warm tone]. Set it toward [Cool tone] if it looks too red.

- **Shoot the subject in close-up.**

If you have a zoom lens, use the telephoto end to shoot the food in close-up.

- **Avoid using flash.**

If you use flash, the light may reflect off the dish or food and results in unnatural shadows. By default, <🚫> (Flash off) is set. Try to prevent camera shake when shooting in low-light conditions.



- Since this mode sets the color tone to make food look vivid, human subjects may be shot in an unsuitable skin tone.
- If you use flash, the [Color tone] setting will switch to the standard setting.

## Shooting Candlelight Portraits

When shooting a human subject in candlelight, use  (Candlelight). The candlelight color tones will be retained in the photo.

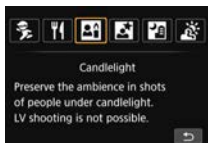

### Shooting Tips

- **Use the center AF point to focus.**  
Aim the center AF point in the viewfinder over the subject, then shoot.
- **Prevent camera shake if the shutter speed in the viewfinder blinks.**  
Under low light when camera shake is prone to occur, the viewfinder's shutter speed display will blink. Hold the camera steady or use a tripod. When using a zoom lens, use the wide-angle end to reduce blur caused by camera shake even while handholding the camera.
- **Change the color tone.**  
You can change [Color tone]. To increase the candlelight's reddish tinge, set it toward [Warm tone]. Set it toward [Cool tone] if it looks too red.



- Live View shooting cannot be used.
- The built-in flash will not fire. In low light, the AF-assist beam may be emitted (p.103).
- If you are using an external Speedlite, the Speedlite will fire.

## Shooting Night Portraits (With a Tripod)

To shoot people at night and obtain a natural-looking night scene in the background, use the  (Night Portrait) mode. Using a tripod is recommended.

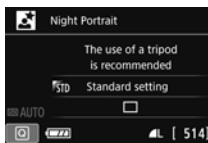
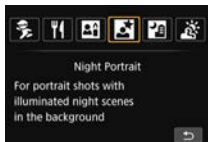

### Shooting Tips

- **Use a wide-angle lens and a tripod.**



When using a zoom lens, use the wide-angle end to obtain a wide night view. Also, use a tripod to prevent camera shake.

- **Check the subject's brightness.**

Under low light, the built-in flash will fire automatically to obtain a good exposure of the subject.

It is recommended to play back the image after shooting to check the image brightness. If the subject looks dark, move nearer and shoot again.

- **Also shoot in other shooting modes.**

Since camera shake is prone to occur with night shots, shooting also with  and  is recommended.

-  ● Tell the subject to keep still even after the flash fires.
- If you use the self-timer together with flash, the self-timer lamp will light up briefly after the picture is taken.
- See the cautions on page 87.

## Shooting Night Scenes (Handheld)

Using a tripod when shooting a night scene gives the best results. However, the  (Handheld Night Scene) mode enables you to shoot night scenes even while handholding the camera. Four shots are taken continuously for each picture, and the resulting one image with reduced camera shake is recorded.





### Shooting Tips

- **Hold the camera firmly.**

While shooting, hold the camera firmly and steadily. In this mode, four shots are aligned and merged into a single image. However, if there is significant misalignment in any of the four shots due to camera shake, they may not align properly in the final image.

- **For shots of people, turn on the flash.**

If you want to include people in the night scene shot, press the  button to set  (Flash on). To take a nice portrait, the first shot will use flash. Tell the subject not to move until all four continuous shots are taken.



See the cautions on page 87.

## Shooting Backlit Scenes

When shooting a scene having both bright and dark areas, use the  (HDR Backlight Control) mode. When you take one picture in this mode, three continuous shots are taken at different exposures. This results in one image, with a wide tonal range, that has minimized the clipped shadows caused by backlighting.

---

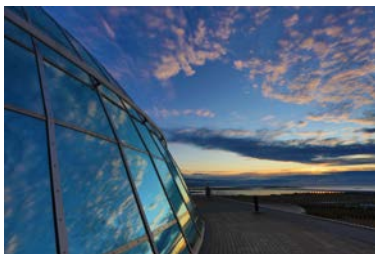
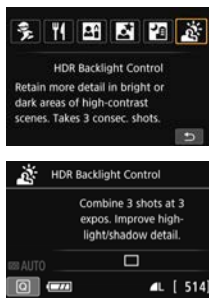

## Shooting Tips

### ● Hold the camera firmly.

While shooting, hold the camera firmly and steadily. In this mode, three shots are aligned and merged into a single image. However, if there is significant misalignment in any of the three shots due to camera shake, they may not align properly in the final image.

-  ● The flash will not fire. In low light, the AF-assist beam may be emitted (p.103).
- See the cautions on page 87.

 HDR stands for High Dynamic Range.



### Cautions for both <P> (Night Portrait) and <P> (Handheld Night Scene)

- During Live View shooting, it may be difficult to focus on dots of light such as in a night scene. In such a case, set the lens's focus mode switch to <MF> and focus manually.
- The Live View image displayed will not look exactly the same as the actual image shot.

### Cautions for <P> (Handheld Night Scene)

- When shooting flash photography, if the subject is too close to the camera, the picture may come out extremely bright (overexposure).
- If you use flash to shoot a night scene with few lights, the shots may not align correctly. This can result in a blurry picture.
- If you use flash and the human subject is close to the background that is also illuminated by the flash, the shots may not align correctly. This can result in a blurry picture. Unnatural shadows and unsuitable colors may also appear.
- External flash coverage:
  - When using a Speedlite with automatic flash coverage setting, the zoom position will be fixed to the wide end, regardless of the lens's zoom position.
  - If you have to set the flash coverage manually, set the light-emitting unit (flash head) to the wide-angle end before shooting.

### Cautions for <P> (Night Portrait)

- During Live View shooting, it may be difficult to focus when the face of the subject looks dark. In such a case, set the lens's focus mode switch to <MF> and focus manually.

### Cautions for both <P> (Handheld Night Scene) and <P> (HDR Backlight Control)

- Compared to other shooting modes, the shooting range will be smaller.
- **RAW** + **L** or **RAW** cannot be selected. If **RAW** + **L** or **RAW** has been set, **L** will be set.
- If you shoot a moving subject, the subject's movement may leave afterimages, or the surrounding area of the subject may become dark.
- The image alignment may not function properly with repetitive patterns (lattice, stripes, etc.), flat or single-tone images, or images significantly misaligned due to camera shake.
- It takes some time to record images to the card since they are merged after shooting. During the processing of the images, "BUSY" will be displayed, and you cannot take another picture until the processing is completed.
- If the shooting mode is set to <P> or <P>, direct printing is not possible.

### ⚠ Cautions for <img alt="HDR Backlight Control icon" data-bbox="265 108 285 128"/> (HDR Backlight Control)

- Note that the image may not be rendered with a smooth gradation and may look irregular or have significant noise.
- HDR Backlight Control may not be effective for excessively backlit scenes or extremely high-contrast scenes.
- When shooting subjects that are sufficiently bright, for example for normally lit scenes, the image may look unnatural because of the applied HDR effect.

## Q Quick Control

In Basic Zone modes when the shooting function settings screen is displayed, you can press the <img alt="Quick Control button icon" data-bbox="285 355 305 375"/> button to display the Quick Control screen. The tables on the next page show the functions that can be set with the Quick Control screen in each Basic Zone mode.

### 1 Set the Mode Dial to a Basic Zone mode.

Example: Portrait mode

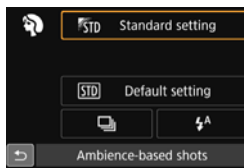

### 2 Press the <img alt="Quick Control button icon" data-bbox="285 495 305 515"/> button (ⓘ10).

- ▶ The Quick Control screen will appear.



### 3 Set the functions.

- Press the <img alt="Cross keys icon" data-bbox="418 715 438 735"/> cross keys to select a function. (This step is not necessary in the <img alt="Movie mode icon" data-bbox="418 755 438 775"/> mode.)
- ▶ The selected function and Feature guide (p.64) will appear.
- Press the <img alt="Left arrow key icon" data-bbox="418 835 438 855"/> <img alt="Right arrow key icon" data-bbox="418 855 438 875"/> keys or turn the <img alt="Sun dial icon" data-bbox="418 855 438 875"/> dial to change the setting.
- You can also select from a list by selecting a function and pressing <img alt="Set button icon" data-bbox="418 925 438 945"/>.



## Settable Functions in Basic Zone Modes

●: Default setting ○: User selectable □: Not selectable

Function							
Drive mode (p.112)	: Single shooting	●	●	●	○	●	●
	: Continuous shooting	○	○	○	●	○	○
	: Silent single shooting	○	○	○	○	○	○
	: Silent continuous shooting	○	○	○	○	○	○
	(10 sec.)	○	○	○	○	○	○
	(2 sec.)	○	○	○	○	○	○
	(Continuous)	○	○	○	○	○	○
Flash firing	: Automatic firing	●		●	●		●
	: Flash on (Fires at all times)	○		○	○		○
	: Flash off	○	●	○	○	●	○
Ambience-based shots (p.90)				○	○	○	○
Light/scene-based shots (p.94)					○	○	○
Background blur (p.74)				○			
Color tone (p.82, 83)							
Extra Effect Shot (p.73)				○			

Function		SCN					
Drive mode (p.112)	: Single shooting	○	●	●	●	●	●
	: Continuous shooting	●	○	○	○	○	○
	: Silent single shooting	○	○	○	○	○	○
	: Silent continuous shooting	○	○	○	○	○	○
	(10 sec.)	○	○	○	○	○	○
	(2 sec.)	○	○	○	○	○	○
	(Continuous)	○	○	○	○	○	○
Flash firing	: Automatic firing	●			●		
	: Flash on (Fires at all times)	○	○			○	
	: Flash off	○	●	●		●	●
Ambience-based shots (p.90)		○	○	○	○	○	
Light/scene-based shots (p.94)		○					
Background blur (p.74)							
Color tone (p.82, 83)			○	○			
Extra Effect Shot (p.73)							

\* If you change the shooting mode or set the power switch to <OFF>, all the functions will revert to the default settings (except the self-timer).

# Shoot by Ambience Selection

Except in the <A+>, <A->, and <A\*> Basic Zone modes, you can select the ambience for shooting.

Ambience	CA / [Icon] / [Icon] / [Icon] / [Icon]	SCN		Ambience Effect
		[Icon] / [Icon] / [Icon]	[Icon] / [Icon]	
[F]STD Standard setting	<input type="radio"/>	<input type="radio"/>	<input type="radio"/>	No setting
[F]V Vivid	<input type="radio"/>	<input type="radio"/>	<input type="radio"/>	Low / Standard / Strong
[F]S Soft	<input type="radio"/>	<input type="radio"/>	<input type="radio"/>	Low / Standard / Strong
[F]W Warm	<input type="radio"/>	<input type="radio"/>	<input type="radio"/>	Low / Standard / Strong
[F]I Intense	<input type="radio"/>	<input type="radio"/>	<input type="radio"/>	Low / Standard / Strong
[F]C Cool	<input type="radio"/>	<input type="radio"/>	<input type="radio"/>	Low / Standard / Strong
[F]B Brighter	<input type="radio"/>	<input type="radio"/>	<input type="radio"/>	Low / Medium / High
[F]D Darker	<input type="radio"/>	<input type="radio"/>	<input type="radio"/>	Low / Medium / High
[F]M Monochrome	<input type="radio"/>	<input type="radio"/>	<input type="radio"/>	Blue / B/W / Sepia

## 1 Set the Mode Dial to any of the following modes: <CA>, <[Icon]>, <[Icon]>, <[Icon]>, <[Icon]>, or <SCN>.

- If the shooting mode is <SCN>, set one of the following: <[Icon]>, <[Icon]>, <[Icon]>, <[Icon]>, or <[Icon]>.



## 2 Display the Live View image.

- Press the <[Icon]> button to display the Live View image (except <[Icon]>).



## 3 On the Quick Control screen, select the desired ambience.

- Press the <Q> button (10).
- Press the <▲> <▼> keys to select [STD Standard setting]. [Ambience-based shots] will appear on the screen.

- Press the <◀> <▶> keys to select the desired ambience.
- ▶ The LCD monitor will display how the image will look with the selected ambience.



#### 4 Set the ambience effect.

- Press the <▲> <▼> keys to select the effect so that [Effect] appears at the bottom.
- Press the <◀> <▶> keys to select the desired effect.

#### 5 Take the picture.

- Press the shutter button completely to take the picture.
- To return to viewfinder shooting, press the <📷> button to exit Live View shooting. Then press the shutter button completely to take the picture.
- If you change the shooting mode or set the power switch to <OFF>, the setting will revert back to [STD Standard setting].



- The Live View image displayed with the ambience setting applied will not look exactly the same as the actual image.
- Using flash may minimize the ambience effect.
- In bright outdoors, the Live View image you see on the LCD monitor may not have exactly the same brightness or ambience as the actual image. Set [Y2: LCD brightness] to 4, and look at the Live View image so that the LCD monitor is unaffected by outside light.





If you do not want the Live View image to be displayed when setting functions, press the <Q> button after step 1 and set [Ambience-based shots] and [Effect].

## Ambience Settings

### **Standard setting**

Standard image characteristics for the respective shooting mode.

Note that < > has image characteristics geared for portraits and < > is geared for landscapes. Each ambience is a modification of the respective shooting mode's image characteristics.

### **Vivid**

The subject will look sharp and vivid. It makes the photo look more impressive than with [ **Standard setting**].

### **Soft**

The subject will look softer and more dainty. Good for portraits, pets, flowers, etc.

### **Warm**

The subject will look softer with warmer colors. Good for portraits, pets, and other subjects to which you want to give a warm look.

### **Intense**

While the overall brightness is slightly lowered, the subject is emphasized for a more intense feeling. Makes the human or living subject stand out more.

### **Cool**

The overall brightness is slightly lowered with a cooler color cast. A subject in the shade will look more calm and impressive.

**B Brighter**

The picture will look brighter.

**D Darker**

The picture will look darker.

**M Monochrome**

The picture will be monochrome. You can select the monochrome color to be blue, black and white, or sepia. When **[Monochrome]** is selected, **<B/W>** will appear in the viewfinder.

## Shoot by Lighting or Scene Type

In the <P>, <A>, <S>, <L>, and <SCN> Basic Zone modes, you can shoot with the settings matching the lighting or scene type. Normally, [STD] **Default setting** is adequate, but if the settings match the lighting condition or scene, the picture will look more accurate to your eyes. For Live View shooting, if you set both [**Light/scene-based shots**] and [**Ambience-based shots**] (p.90), you should first set [**Light/scene-based shots**]. This will make it easier to see the resulting effect on the LCD monitor.

Lighting or Scene					SCN
[STD] Default setting	<input type="radio"/>	<input type="radio"/>	<input type="radio"/>	<input type="radio"/>	<input type="radio"/>
Daylight	<input type="radio"/>	<input type="radio"/>	<input type="radio"/>	<input type="radio"/>	<input type="radio"/>
Shade	<input type="radio"/>	<input type="radio"/>	<input type="radio"/>	<input type="radio"/>	<input type="radio"/>
Cloudy	<input type="radio"/>	<input type="radio"/>	<input type="radio"/>	<input type="radio"/>	<input type="radio"/>
Tungsten light	<input type="radio"/>	<input checked="" type="radio"/>	<input type="radio"/>	<input type="radio"/>	<input type="radio"/>
Fluorescent light	<input type="radio"/>	<input checked="" type="radio"/>	<input type="radio"/>	<input type="radio"/>	<input type="radio"/>
Sunset	<input type="radio"/>	<input type="radio"/>	<input type="radio"/>	<input type="radio"/>	<input type="radio"/>

**1** Set the Mode Dial to any of the following modes: <P>, <A>, <S>, <L>, or <SCN>.

- For <SCN>, set it to <SCN>.

**2** Display the Live View image.

- Press the <Live View icon> button to display the Live View image.





### 3 On the Quick Control screen, select the lighting or scene type.

- Press the <[Q]> button (ⓘ10).
- Press the <▲> <▼> keys to select [**STD Default setting**]. [**Light/scene-based shots**] will appear on the screen.
- Press the <◀> <▶> keys to select the lighting or scene type.
- ▶ The resulting image with the selected lighting or scene type will be displayed.

### 4 Take the picture.

- Press the shutter button completely to take the picture.
- To return to viewfinder shooting, press the <📷> button to exit Live View shooting. Then press the shutter button completely to take the picture.
- If you change the shooting mode or set the power switch to <OFF>, the setting will revert back to [**STD Default setting**].



- If you use flash, the setting will switch to [**STD Default setting**]. (However, the shooting information will display the lighting or scene type that is set.)
- If you want to set this together with [**Ambience-based shots**], set the lighting or scene type that best matches the ambience you have set. In the case of [**Sunset**], for example, warm colors will become prominent so the ambience you set may not work well.



If you do not want the Live View image to be displayed when setting functions, press the <[Q]> button after step 1 and set [**Light/scene-based shots**].

## Lighting or Scene Type Settings

### **Default setting**

Default setting suited for most subjects.

### **Daylight**

For subjects under sunlight. Gives more natural-looking blue skies and greenery and reproduces light-colored flowers better.

### **Shade**

For subjects in the shade. Suitable for skin tones, which may look too bluish, and for light-colored flowers.

### **Cloudy**

For subjects under overcast skies. Makes skin tones and landscapes, which may otherwise look dull on a cloudy day, look warmer. Also effective for light-colored flowers.

### **Tungsten light**

For subjects lit under tungsten lighting. Reduces the reddish-orange color cast caused by tungsten lighting.

### **Fluorescent light**

For subjects under fluorescent lighting. Suited for all types of fluorescent lighting.

### **Sunset**

Suitable when you want to capture the sunset's impressive colors.



## ▶ Image Playback

The easiest way to play back images is explained below. For more details on the playback procedure, see page 277.

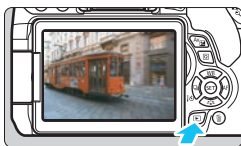

### 1 Play back the image.

- Press the <▶> button.
- ▶ The last image captured or played back will appear.



### 2 Select an image.

- To play back images starting with the last image captured, press the <◀> key. To play back images starting with the first captured image, press the <▶> key.
- Each time you press the <INFO.> button, the information display will change.



No information



Basic information display



Shooting information display

### 3 Exit the image playback.

- Press the <▶> button to exit the image playback and return to shooting-ready state.

## Shooting Information Display

With the shooting information screen displayed (p.97), you can press the <▲> <▼> keys to change the shooting information displayed at the screen's bottom as follows. For details, see pages 307-308.

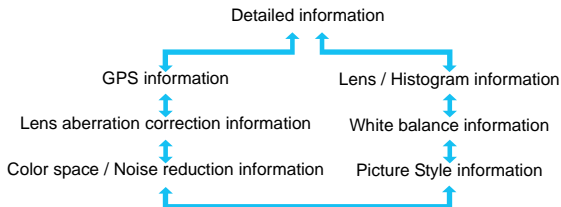

- The information displayed varies depending on the shooting mode and settings.
- If GPS information is not recorded for the image, the GPS information screen will not be displayed.

# 3

## Setting the AF and Drive Modes

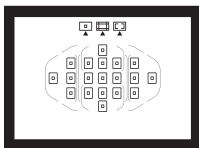

The 19 AF points in the viewfinder make AF shooting suitable for a wide variety of subjects and scenes.

You can also select the AF operation and drive mode that best match the shooting conditions and subject.

- The ☆ icon at the upper right of the page title indicates that the function is available only in Creative Zone modes (p.30).
- In Basic Zone modes, the AF operation and AF point (AF area selection mode) are set automatically.



<AF> stands for autofocus. <MF> stands for manual focus.

# AF: Changing the Autofocus Operation ☆

You can select the AF (autofocus) operation characteristics suiting the shooting conditions or subject. In Basic Zone modes, the optimum AF operation is set automatically for the respective shooting mode.

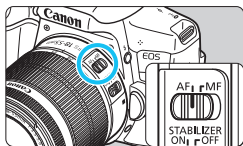

- 1 **Set the lens's focus mode switch to <AF>.**

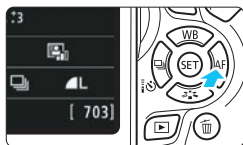

- 2 **Press the <▶ AF> button.**
  - ▶ [AF operation] will appear.

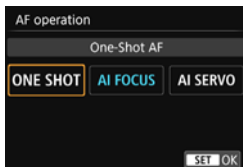

- 3 **Select the AF operation.**
  - Press the <◀> <▶> keys to select the desired AF operation, then press <SET>.

- 4 **Focus on the subject.**
  - Aim the AF point over the subject and press the shutter button halfway. The camera will then autofocus in the selected AF operation.

## One-Shot AF for Still Subjects

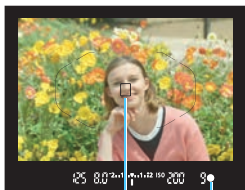

AF point

Focus indicator

**Suited for still subjects. When you press the shutter button halfway, the camera will focus only once.**

- When focus is achieved, the AF point that achieved focus will be displayed, and the focus indicator <●> in the viewfinder will also light up.
  - With evaluative metering, the exposure setting will be set at the same time focus is achieved.
- While you hold down the shutter button halfway, the focus will be locked. You can then recompose the shot if desired.



- If focus cannot be achieved, the focus indicator <●> in the viewfinder will blink. If this occurs, the picture cannot be taken even if the shutter button is pressed completely. Recompose the shot or see “Subjects Difficult to Focus on” (p.110) and try to focus again.
- If [CAM 1: Beep] is set to [Disable], the beeper will not sound when focus is achieved.
- After achieving focus with One-Shot AF, you can lock the focus on a subject and recompose the shot. This is called “focus lock”. This is convenient when you want to focus on a peripheral subject not covered by the Area AF frame.
- When a lens equipped with electronic manual focusing function is used, after achieving focus, you can focus manually by turning the lens focusing ring while pressing the shutter button halfway.

## AI Servo AF for Moving Subjects

**This AF operation is suited for moving subjects when the focusing distance keeps changing. While you hold down the shutter button halfway, the subject will be focused on continuously.**

- The exposure is set at the moment the picture is taken.
- When the AF area selection mode is set to 19-point automatic selection AF (p.104), the camera first uses the manually-selected AF point to focus. During autofocusing, if the subject moves away from the manually-selected AF point, focus tracking continues as long as the subject is covered by the Area AF frame.

 With AI Servo AF, the beeper will not sound even when focus is achieved. Also, the focus indicator <●> in the viewfinder will not light up.

## AI Focus AF for Switching the AF Operation Automatically

**AI Focus AF switches the AF operation from One-Shot AF to AI Servo AF automatically if a still subject starts moving.**

- After the subject is focused on in One-Shot AF, if the subject starts moving, the camera will detect the movement, change the AF operation automatically to AI Servo AF, and start tracking the moving subject.

 When focus is achieved with AI Focus AF with the Servo operation active, the beeper will continue beeping softly. However, the focus indicator <●> in the viewfinder will not light up. Note that focus will not be locked in this case.

## AF Points Lighting Up in Red

By default, the AF points light up in red when focus is achieved in low-light conditions. In Creative Zone modes, you can set whether to have the AF points light up in red when focus is achieved (p.342).

## AF-Assist Beam with the Built-in Flash

Under low-light conditions, when you press the shutter button halfway, the built-in flash may fire a brief burst of flashes. This illuminates the subject to help autofocusing.



- The AF-assist beam will not be emitted from the built-in flash in the following shooting modes: <img alt="Movie mode icon" data-bbox="365 380 385 395"/>, <img alt="Movie mode icon" data-bbox="395 380 415 395"/>, <img alt="Movie mode icon" data-bbox="425 380 445 395"/>, and <img alt="Movie mode icon" data-bbox="455 380 475 395"/>.
- The AF-assist beam will not be emitted with AI Servo AF operation.
- The built-in flash makes a sound when firing continuously. This is normal and not a malfunction.



- The effective range of the AF-assist beam emitted by the built-in flash is approx. 4 meters/13.1 feet.
- In Creative Zone modes, when you raise the built-in flash with the <img alt="Flash up icon" data-bbox="870 535 890 550"/> button (p.166), the AF-assist beam will be emitted when necessary. Note that depending on the setting for [4: AF-assist beam firing] under [4: Custom Functions (C.Fn)], AF-assist beam will not be emitted (p.340).

## Selecting the AF Area and AF Point <sup>☆</sup>

19 AF points are provided for autofocusing. You can select the AF area selection mode and AF point(s) suiting the scene or subject.

### AF Area Selection Mode

You can select one of three AF area selection modes. See the next page for the selection procedure.

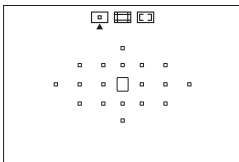

#### : Single-point AF (Manual selection)

Select one AF point to focus.

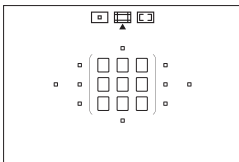

#### : Zone AF (Manual selection of zone)

The 19 AF points are divided into five zones for focusing.

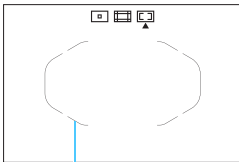

#### : 19-point automatic selection AF

All the AF points are used to focus. **This mode is set automatically in Basic Zone modes** (except < >).

Area AF frame



## Selecting the AF Area Selection Mode

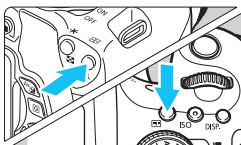

**1 Press the <☰> or <☰> button (⌚6).**

- Look through the viewfinder and press the <☰> or <☰> button.

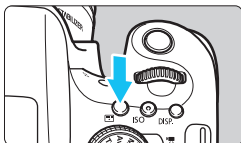

**2 Press the <☰> button.**

- Each time you press the <☰> button, the AF area selection mode changes.
- The AF area selection mode currently set is indicated on the top of the viewfinder.

AF area selection mode

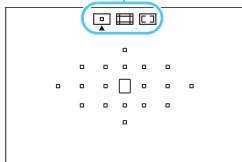

☐ : **Single-point AF**

(Manual selection)

☐☐☐ : **Zone AF**

(Manual selection of zone)

☐☐☐☐☐☐☐ : **19-point automatic selection AF**



Under [**4: Custom Functions (C.Fn)**], if you set [**5: AF area selection method**] to [**1: ☐ → Main Dial**], you can select the AF area selection mode by pressing the <☰> or <☰> button, then turning the <☰> dial (p.340).

## Selecting the AF Point Manually

You can manually select the AF point or zone. If 19-point automatic selection AF + AI Servo AF has been set, you can select any position where AI Servo AF is to start.

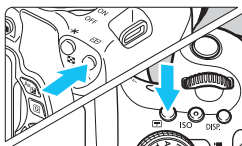

### 1 Press the or button (☉6).

- ▶ The AF points will be displayed in the viewfinder.
- In the Zone AF mode, the selected zone will be displayed.

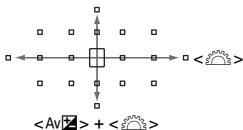

### 2 Select an AF point.

- You can select an AF point by shifting horizontally with the dial or vertically with the dial while holding down the button. If you press , the center AF point (or center zone) will be selected.
- In the Zone AF mode, turning the dial will change the zone in a looping sequence.
- You can also select an AF point or zone by shifting horizontally with the keys or vertically with the keys.

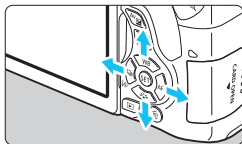

When you press the or button, the viewfinder displays the following:

- 19-point automatic selection AF and Zone AF (manual selection of zone):  
 AF
- 1 pt AF (Manual selection): **SEL [ ]** (Center)/**SEL AF** (Off center)

# AF Area Selection Modes ☆

## ☐ Single-point AF (Manual Selection)

Select one AF point <☐> to be used for focusing.



## ☐ Zone AF (Manual Selection of Zone)

The 19 AF points are divided into five zones for focusing. All the AF points in the selected zone are used for the automatic selection of the focusing point(s). It is effective for moving subjects.

However, since it is inclined to focus the nearest subject, focusing a specific target is harder than with single-point AF.

The AF point(s) achieving focus is displayed as <☐>.

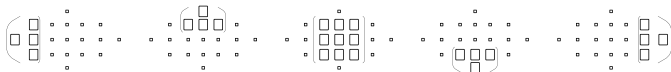



## 19-point Automatic Selection AF

All the AF points are used to focus. This mode is set automatically in Basic Zone modes (except <>).

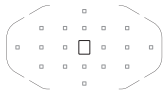

With One-Shot AF, pressing the shutter button halfway will display the AF point(s) <> that achieved focus. If multiple AF points are displayed, it means they all have achieved focus.



With AI Servo AF, the manually-selected (p.106) AF point <> is used first to achieve focus. The AF point(s) achieving focus is displayed as <>.

## AF Using Color Tone Detection

Configuring the following makes it easier to focus on still human subject.

- Set the AF operation to One-Shot AF.
- Set the AF area selection mode to Zone AF (manual selection of zone) or 19-point automatic selection AF.
- Under [**4: Custom Functions (C.Fn)**], set [**6: Auto AF point selection: Color Tracking**] to [**0: One-Shot AF only**] (if set to [**1: Disable**], basically the nearest subject will be focused on) (p.341).

- When AI Servo AF mode is set with 19-point automatic selection AF or Zone AF, the active AF point <> will keep switching to track the subject. However, under certain shooting conditions (such as when the subject is small), it may not be able to track the subject. Also, in low temperatures, the tracking response is slower.
- If the camera cannot focus with the EOS-dedicated external Speedlite's AF-assist beam, set the AF area selection mode to Single-point AF (manual selection) and select the center AF point to autofocus.
- When the AF point(s) light up, part or all of the viewfinder may light up in red. This is a characteristic of AF point display using liquid crystal.
- In low temperatures, it may sometimes become difficult to see the AF point display because of its characteristics using liquid crystal.

## AF Operation and Maximum Lens Apertures

### Maximum Lens Aperture: f/3.2 - f/5.6

With all AF points, cross-type AF sensitive to both vertical and horizontal lines is possible. However, with the lenses below, the peripheral AF points will detect only vertical or horizontal lines (no cross-type focusing).



### Lenses that Do Not Support Cross-Type Focusing with Peripheral AF Points

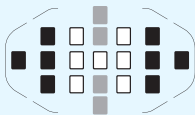

- Cross-type focusing
- Vertical line-sensitive focusing
- Horizontal line-sensitive focusing

Cross-type focusing at the  and  AF points is not possible with the following lenses:

EF35-80mm f/4-5.6, EF35-80mm f/4-5.6 II, EF35-80mm f/4-5.6 III,  
 EF35-80mm f/4-5.6 USM, EF35-105mm f/4.5-5.6, EF35-105mm f/4.5-5.6  
 USM, EF80-200mm f/4.5-5.6 II, EF80-200mm f/4.5-5.6 USM

### Maximum Lens Aperture: f/1.0 - f/2.8

Besides cross-type focusing (vertical and horizontal lines detected simultaneously), the center AF point can also perform high-precision, vertical-line sensitive AF.\*

The remaining 18 AF points perform cross-type focusing, as with the maximum aperture at f/3.2 - f/5.6.

\* Except with the EF28-80mm f/2.8-4L USM and EF50mm f/2.5 Compact Macro.

## Subjects Difficult to Focus on

Autofocus can fail to achieve focus (viewfinder's focus indicator <●> blinks) with certain subjects such as the following:

- Very low-contrast subjects  
(Example: Blue sky, solid-color walls, etc.)
- Subjects in very low light
- Strongly backlit or reflective subjects  
(Example: Car with a highly reflective body, etc.)
- Near and distant subjects framed close to an AF point  
(Example: Animal in a cage, etc.)
- Subjects such as dots of light framed close to an AF point  
(Example: Night scenes, etc.)
- Repetitive patterns  
(Example: Skyscraper windows, computer keyboards, etc.)

In such cases, do either of the following:

- (1) With One-Shot AF, focus on an object at the same distance as the subject and lock the focus before recomposing the shot (p.69).
- (2) Set the lens's focus mode switch to <MF> and focus manually.



- Depending on the subject, focus may be achieved by slightly recomposing the shot and performing AF operation again.
- Conditions that make focusing difficult with AF during Live View shooting or movie shooting are listed on page 212.

## MF: Manual Focus

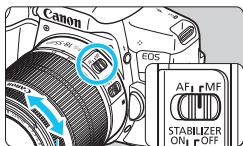

Focusing ring

- 1 Set the lens focus mode switch to **<MF>**.
- 2 **Focus on the subject.**
  - Focus by turning the lens focusing ring until the subject looks sharp in the viewfinder.



If you press the shutter button halfway during manual focusing, the AF point that achieved focus and the focus indicator **<●>** will light up in the viewfinder.

## Selecting the Drive Mode

Single and continuous drive modes are provided.



### 1 Press the <◀|📷|▶> button.

▶ [Drive mode] will appear.

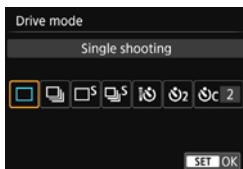

### 2 Select the drive mode.

- Press the <◀> <▶> keys to select the desired drive mode, then press <📷>.

#### : **Single shooting**

When you press the shutter button completely, only one shot will be taken.

#### : **Continuous shooting** (Max. approx. 5.0 shots/sec.)

While you hold down the shutter button completely, shots will be taken continuously.

#### S : **Silent single shooting**

Single shooting with less shooting sound than <📷>.

#### S : **Silent continuous shooting** (Max. approx. 3.0 shots/sec.)

Continuous shooting with less shooting sound than <📷>.

#### 🕒 : **Self-timer: 10sec./remote control**

#### 🕒2 : **Self-timer: 2 sec.**

#### 🕒c : **Self-timer: Continuous**

For self-timer shooting, see page 114. For remote control shooting, see page 350.





- If <img alt="Single Shot icon" data-bbox="170 105 195 125"/>S> or <img alt="Continuous Shooting icon" data-bbox="170 170 195 190"/>S> is set, the time lag from when you press the shutter button completely until the picture is shot will be longer than with normal single or continuous shooting.
- With Live View shooting, <img alt="Single Shot icon" data-bbox="170 105 195 125"/>S> and <img alt="Continuous Shooting icon" data-bbox="170 170 195 190"/>S> cannot be set.
- When the battery level is low, the continuous shooting speed may become slightly slower.
- In AI Servo AF operation, the continuous shooting speed may become slightly slower depending on the subject and the lens used.
- : The maximum continuous shooting speed of approx. 5.0 shots/sec. is attained under the following conditions\*: At 1/500 sec. or faster shutter speed, at maximum aperture (varies depending on the lens), Distortion correction: Disable, and Anti-flicker shooting: Disable. The continuous shooting speed may decrease depending on the shutter speed, aperture, subject conditions, brightness, lens, flash use, temperature, remaining battery level, etc.

\* Set the AF operation mode to One-Shot AF and the Image Stabilizer (IS) switch to OFF when using the following lenses: EF300mm f/4L IS USM, EF28-135mm f/3.5-5.6 IS USM, EF75-300mm f/4-5.6 IS USM, and EF100-400mm f/4.5-5.6L IS USM.

## Using the Self-timer



### 1 Press the **<◀▶⏸▶>** button.

▶ [Drive mode] will appear.

### 2 Select the self-timer.

● Press the **<◀><▶>** keys to select the self-timer, then press **<SET>**.

**⏸:** 10-sec. self-timer

The remote controller can also be used (p.350).

**⏸<sub>2</sub>:** 2-sec. self-timer (p.75)

**⏸<sub>C</sub>:** 10-sec. self-timer plus continuous shots

Press the **<▲><▼>** keys to set the number of multiple shots (2 to 10) to be taken with the self-timer.

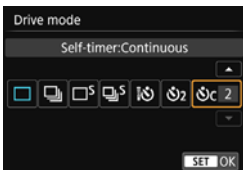

### 3 Take the picture.

● Look through the viewfinder, focus on the subject, then press the shutter button completely.

▶ You can check the self-timer operation with the self-timer lamp, beeper, and countdown display (in seconds) on the LCD monitor.

▶ Two sec. before the picture is taken, the self-timer lamp will light up and the beeper will sound faster.

- With **<⏸<sub>C</sub>>**, the interval between the multiple shots may be prolonged depending on the shooting functions settings such as the image-recording quality or flash.
- If you do not look through the viewfinder when you press the shutter button, attach the eyepiece cover (p.351). If stray light enters the viewfinder when the picture is taken, it may throw off the exposure.

- After taking self-timer shots, playing back the image (p.97) to check focus and exposure is recommended.
- When using the self-timer to shoot yourself, use focus lock (p.69) on an object at the same distance as where you will stand.
- To cancel the self-timer after it starts, either touch the LCD monitor or press the **<◀▶⏸▶>** button.

# 4

## Image Settings

This chapter explains image-related function settings: Image-recording quality, ISO speed, Picture Style, white balance, Auto Lighting Optimizer, noise reduction, lens aberration correction, anti-flicker shooting, and other functions.

- In Basic Zone modes, only the following can be set as described in this chapter: Image-recording quality and lens aberration correction.
- The ☆ icon at the upper right of the page title indicates that the function is available only in Creative Zone modes (p.30).

## MENU Setting the Image-Recording Quality

You can select the pixel count and the image quality. Ten image-recording quality settings are provided: **L**, **L**, **M**, **M**, **S1**, **S1**, **S2**, **S3**, **RAW+L**, **RAW**.

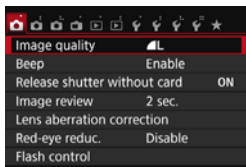

### 1 Select the image-recording quality.

- Under the [**1**] tab, select [**Image quality**], then press <SET>.
- ▶ [**Image quality**] will appear.

Pixels recorded (pixel count)

Possible shots

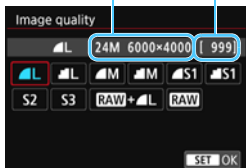

### 2 Set the image-recording quality.

- The respective quality's pixel count and number of possible shots will be displayed to help you select the desired quality. Then press <SET>.

## Guide to Image-recording Quality Settings

(Approx.)

Image Quality			Pixels Recorded (megapixels)	File Size (MB)	Possible Shots	Maximum Burst	
L	High quality	JPEG	24 (24M)	7.6	940	180 (940)	
				3.9	1810	1810 (1810)	
M	Medium quality		10.6 (11M)	4.0	1770	1770 (1770)	
				2.0	3500	3500 (3500)	
S1	Low quality		5.9 (5.9M)	2.5	2830	2830 (2830)	
				1.3	5320	5320 (5320)	
S2			2.5 (2.5M)	1.3	5320	5320 (5320)	
S3			0.35 (0.3M)	0.3	20180	20180 (20180)	
L			High quality	24 (24M)	28.1+7.6	190	6 (6)
RAW					28.1	240	7 (8)

\* The file size, possible shots, and maximum burst during continuous shooting are based on Canon's testing standards (3:2 aspect ratio, ISO 100 and Standard Picture Style) using an 8 GB card. **These figures will vary by the subject, card brand, aspect ratio, ISO speed, Picture Style, Custom Functions, and other settings.**

\* Figures in parentheses apply to an UHS-I compatible 8 GB card based on Canon's testing standards.



Even if you use a UDMA card, the maximum burst indicator remains the same. However, the maximum burst in parentheses in the above table will be applied during continuous shooting.

## ? FAQ

- I want to select the image-recording quality matching the paper size for printing.

### Paper size

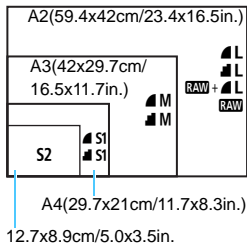

Refer to the diagram on the left when choosing the image-recording quality. If you want to crop the image, selecting a higher quality (more pixels) such as **L**, **L**, **L**, **RAW** + **L**, or **RAW** is recommended. **S2** is suitable for playing back the image with a digital photo frame. **S3** is suitable for emailing the image or using it on a Web site.

- What's the difference between **L** and **L**?

These settings indicate the different levels of image quality caused by different compression rates. The **L** setting produces a higher image quality with the same number of pixels. Although **L** produces a slightly lower image quality, this allows more images to be saved on the card. Both **S2** and **S3** have **L** (Fine) quality.

- I was able to take more shots than the number of possible shots indicated.

Depending on the shooting conditions, you may be able to take more shots than is indicated. It may also be fewer than indicated. The number of possible shots displayed is only approximate.

- Does the camera display the maximum burst?

The maximum burst is displayed on the viewfinder's right side. Since it is only a single-digit indicator **0 - 9**, any number higher than 8 will be displayed only as "9". Note that this number will also be displayed even when no card is installed in the camera. Be careful not to shoot without a card in the camera.

- When should I use **RAW**?

**RAW** images must be processed on a computer. For details, see "**RAW**" and "**RAW** + **L**" on the next page.

**RAW**

**RAW** is the raw image data before it is made into **L** or other images. **RAW** images cannot be viewed on a computer without the use of EOS software, such as Digital Photo Professional (p.404). However, you can perform various adjustments on them that are impossible with other image types such as **L**. **RAW** is effective when you want to precisely adjust the image yourself or shoot an important subject.

**RAW + L**

**RAW + L** records a **RAW** image and a **L** image with a single shot. The two images are saved to the card simultaneously. The two images will be saved in the same folder with the same file numbers (file extension .JPG for JPEG and .CR2 for RAW). **L** images can be viewed or printed even with a computer which does not have the EOS software installed.

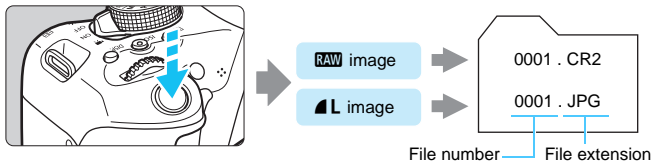

### RAW Image Processing Software

- The use of “Digital Photo Professional” (EOS software, p.404) is recommended when viewing RAW images on a computer.
- Older versions of Digital Photo Professional may not be able to process RAW images taken with this camera. If an older version of Digital Photo Professional is installed on your computer, update (overwrite) it as follows.
  - When the software CD-ROM (EOS DIGITAL Solution Disk) is provided with the camera:
    - Install Digital Photo Professional from the CD-ROM.
  - When the software CD-ROM (EOS DIGITAL Solution Disk) is not provided with the camera:
    - Download a version of Digital Photo Professional compatible with this camera from the Canon Web site.
- Commercially-available software may not be able to display RAW images taken with this camera. For compatibility information, contact the software manufacturer.

## MENU Changing the Image's Aspect Ratio ☆

You can change the image's aspect ratio. [3:2] is set by default. When [4:3], [16:9], or [1:1] is set, lines will appear to indicate the shooting range. During Live View shooting, the image appears with the surrounding area masked in black.

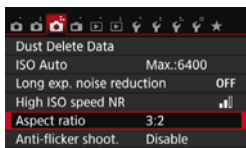

### 1 Select the aspect ratio.

- Under the [CAMERA] tab, select [Aspect ratio], then press <SET>.
- ▶ [Aspect ratio] will appear.

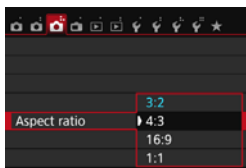

### 2 Set the aspect ratio.

- Select an aspect ratio, then press <SET>.

#### ● JPEG images

The images will be saved with the set aspect ratio.

#### ● RAW images

The images will always be saved with the [3:2] aspect ratio. The selected aspect ratio information is added to the RAW image file. When you process the RAW image with the EOS software, this allows you to generate an image with the same aspect ratio that was set for shooting. In the case of the [4:3], [16:9], and [1:1] aspect ratios, the lines to indicate the aspect ratio will appear during image playback, but they are not actually drawn on the image.



The table below shows the aspect ratio and the number of recorded pixels for each image-recording quality.

Image Quality	Aspect Ratio and Pixel Count (approx.)			
	3:2	4:3	16:9	1:1
<b>L</b>	6000x4000	5328x4000*	6000x3368*	4000x4000
<b>RAW</b>	(24.0 megapixels)	(21.3 megapixels)	(20.2 megapixels)	(16.0 megapixels)
<b>M</b>	3984x2656 (10.6 megapixels)	3552x2664 (9.5 megapixels)	3984x2240* (8.9 megapixels)	2656x2656 (7.1 megapixels)
<b>S1</b>	2976x1984 (5.9 megapixels)	2656x1992 (5.3 megapixels)	2976x1680* (5.0 megapixels)	1984x1984 (3.9 megapixels)
<b>S2</b>	1920x1280 (2.5 megapixels)	1696x1280* (2.2 megapixels)	1920x1080 (2.1 megapixels)	1280x1280 (1.6 megapixels)
<b>S3</b>	720x480 (0.35 megapixels)	640x480 (0.31 megapixels)	720x408* (0.29 megapixels)	480x480 (0.23 megapixels)



- The asterisked image-recording quality settings do not match the respective aspect ratio exactly.
- The shooting range displayed for the asterisked aspect ratio is slightly larger than the recorded area. Check the captured images on the LCD monitor when shooting.
- If you use a different camera to directly print images shot with this camera in the 1:1 aspect ratio, the images may not be correctly printed.

# ISO: Changing the ISO Speed to Suit the Light ★

Set the ISO speed (image sensor's sensitivity to light) to suit the ambient light level. In Basic Zone modes, the ISO speed is set automatically (p.124).

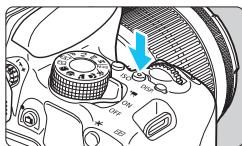

1 Press the <ISO> button (ⓘ6).

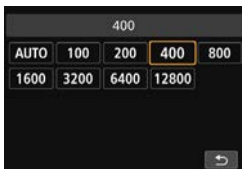

2 Set the ISO speed.

- While looking in the viewfinder or at the LCD monitor, press the <◀> <▶> keys or turn the <⚙> dial to select the desired ISO speed, then press <SET>.
- ▶ Select [AUTO] to set the ISO speed automatically (p.124).

## ISO Speed Guide

ISO Speed	Shooting Situation (No flash)	Flash Range
ISO 100 - ISO 400	Sunny outdoors	The higher the ISO speed, the farther the flash range will extend (p.166).
ISO 400 - ISO 1600	Overcast skies or evening time	
ISO 1600 - ISO 12800, H	Dark indoors or night	

\* High ISO speeds will result in grainier images.

 Under [**4: Custom Functions (C.Fn)**], if [**2: ISO expansion**] is set to [**1: On**], "H" (equivalent to ISO 25600) can also be selected (p.338).

- Under [**4: Custom Functions (C.Fn)**], if [**3: Highlight tone priority**] is set to [**1: Enable**], ISO 100 and "H" (equivalent to ISO 25600) cannot be selected (p.339).
- Shooting in high temperatures may result in images that look grainier. Long exposures can also cause irregular colors in the image.



- When you shoot at high ISO speeds, noise (such as dots of light and banding) may become noticeable.
- If you use a high ISO speed and flash to shoot a close subject, overexposure may result.
- When shooting in conditions that produce an extreme amount of noise, such as a combination of high ISO speed, high temperature and long exposure, images may not be recorded properly.
- As "H" (equivalent to ISO 25600) is an expanded ISO speed setting, noise (such as dots of light and banding) and irregular colors will be more noticeable, and the resolution will be lower than usual.
- As the maximum ISO speed that can be set differs between still photo shooting and movie shooting (manual exposure), the ISO speed you set may change when you switch from still photo shooting to movie shooting. Even if you switch back to still photo shooting, the ISO speed will not revert to the original setting. The maximum ISO speed that can be set varies depending on the setting for [2: ISO expansion] under [4: Custom Functions (C.Fn)].
  - When [0: Off] is set: If you set ISO 12800 during still photo shooting and then switch to movie shooting, ISO speed will be changed to ISO 6400.
  - When [1: On] is set: If you set ISO 12800 or "H" (equivalent to ISO 25600) during still photo shooting and then switch to movie shooting, ISO speed will be changed to "H" (equivalent to ISO 12800).

### **MENU** Setting the Maximum ISO Speed for [AUTO] <sup>☆</sup>

For ISO Auto, you can set the maximum ISO speed limit within ISO 400 - ISO 6400.

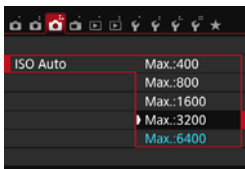

Under the [CAMERA 3] tab, select [ISO Auto], then press <SET>. Select the ISO speed, then press <SET>.

## ISO [AUTO]

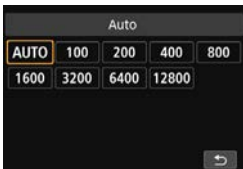

If the ISO speed is set to [AUTO], the actual ISO speed setting will be displayed when you press the shutter button halfway. As indicated below, the ISO speed will be set automatically to suit the shooting mode.

Shooting Mode	ISO Speed Setting		
	No Flash	With Flash	
	ISO 100 - ISO 6400	ISO 400*2 (Except in the  ,  , , and  modes.)	
	ISO 100 - ISO 1600		
SCN			ISO 100 - ISO 6400
			ISO 100 - ISO 12800
P/Tv/Av/M	ISO 100 - ISO 6400*1		
With bulb exposures	ISO 400		

\*1: Depends on the maximum ISO speed limit set (p.123).

\*2: (1) If fill flash results in overexposure, ISO 100 or a higher ISO speed will be set.

- (2) In the , , , , , , , , and <P> modes, if you use bounce flash with an external Speedlite, the ISO speed will be automatically set within ISO 400 - ISO 1600 (or up to the maximum limit).

When [AUTO] is set, the ISO speed is indicated in whole-stop increments. However, the ISO speed is actually set in finer increments. Therefore, in the image's shooting information (p.306), you may find an ISO speed such as ISO 125 or ISO 640 displayed as the ISO speed.

## Selecting a Picture Style ☆

By selecting a Picture Style, you can obtain image characteristics matching your photographic expression or the subject.

In Basic Zone modes, [] (Auto) is set automatically.



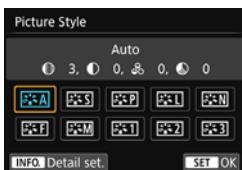

### 1 Press the button.

- ▶ The Picture Style selection screen will appear.



### 2 Select a Picture Style.

- Select a Picture Style, then press .
- ▶ The Picture Style will be set.

 You can also set the Picture Style with [2: Picture Style].

## Picture Style Characteristics

### Auto

The color tones will be adjusted automatically to suit the scene. The colors will look vivid, especially for blue skies, greenery and sunsets, and in nature, outdoor and sunset scenes.

 If the desired color tone is not obtained with [**Auto**], use another Picture Style.

### Standard

The image looks vivid, sharp, and crisp. This is a general-purpose Picture Style suitable for most scenes.

### **Portrait**

For nice skin tones. The image looks softer. Suited for close-up portraits.

By changing the [**Color tone**] (p.128), you can adjust the skin tone.

### **Landscape**

For vivid blues and greens, and very sharp and crisp images. Effective for impressive landscapes.

### **Neutral**

This Picture Style is for users who prefer to process images with their computer. For natural colors and subdued images with modest brightness and color saturation.

### **Faithful**

This Picture Style is for users who prefer to process images with their computer. The color of a subject that is captured in sunlight at a color temperature of 5200K will be adjusted to match the subject's colorimetric color. For subdued images with modest brightness and color saturation.

### **Monochrome**

Creates black-and-white images.



Black-and-white images shot in JPEG cannot be turned into color. If you want to later shoot pictures in color, make sure the [**Monochrome**] setting is canceled. When [**Monochrome**] is selected, <**B/W**> will appear in the viewfinder.

### **User Def. 1-3**

You can register a base style such as [**Portrait**], [**Landscape**], a Picture Style file, etc., and adjust it as desired (p.130). Any User Defined Picture Style that has not been set will have the same default settings as the [**Auto**] Picture Style.

## Customizing a Picture Style ☆

You can customize a Picture Style by adjusting individual parameters such as **[Sharpness]** and **[Contrast]**. To see the resulting effects, take test shots. To customize **[Monochrome]**, see page 129.

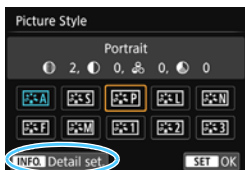

### 1 Press the <▼> > button.

- ▶ The Picture Style selection screen will appear.

### 2 Select a Picture Style.

- Select a Picture Style, then press the <INFO.> button.

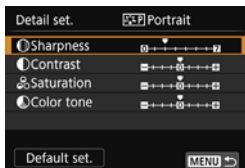

### 3 Select a parameter.

- Select a parameter such as **[Sharpness]**, then press <SET>.

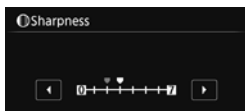

### 4 Set the parameter.

- Press the <◀> <▶> keys to adjust the parameter as desired, then press <SET>.
- Press the <MENU> button to save the adjusted parameters. The Picture Style selection screen will reappear.
- ▶ Any parameter settings different from the default will be displayed in blue.

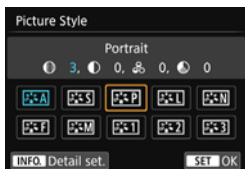

- By selecting **[Default set.]** in step 3, you can revert the parameter settings of the respective Picture Style to its default.
- To shoot with the Picture Style you adjusted, follow step 2 on page 125 to select the adjusted Picture Style, then shoot.

## Parameter Settings and Effects

### Sharpness

**Adjusts the sharpness of the image.**

To make it less sharp, set it toward the **0** end. The closer it is to **0**, the softer the image will look.

To make it sharper, set it toward the **7** end. The closer it is to **7**, the sharper the image will look.

### Contrast

**Adjusts the image contrast and the vividness of colors.**

To decrease the contrast, set it toward the minus end. The closer it is to **-**, the more muted the image will look.

To increase the contrast, set it toward the plus end. The closer it is to **+**, the crisper the image will look.

### Saturation

**Adjusts the color saturation in the image.**

To decrease the color saturation, set it toward the minus end. The closer it is to **-**, the more diluted the colors will look.

To increase the color saturation, set it toward the plus end. The closer it is to **+**, the bolder the colors will look.

### Color tone

**Adjusts the color tone of skin.**

To make the skin tone redder, set it toward the minus end. The closer it is to **-**, the redder the skin tone will look.

To reduce skin redness, set it toward the plus end. The closer it is to **+**, the more yellow the skin tone will look.



## Monochrome Adjustment

For Monochrome, you can also set **[Filter effect]** and **[Toning effect]** in addition to **[Sharpness]** and **[Contrast]** explained on the preceding page.

### Filter Effect

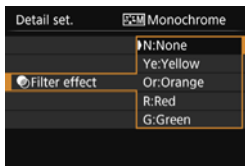

With a filter effect applied to a monochrome image, you can make white clouds or green trees stand out more.

Filter	Sample Effects
N: None	Normal black-and-white image with no filter effects.
Ye: Yellow	The blue sky will look more natural, and the white clouds will look crisper.
Or: Orange	The blue sky will look slightly darker. The sunset will look more brilliant.
R: Red	The blue sky will look quite dark. Fall leaves will look crisper and brighter.
G: Green	Skin tones and lips will appear muted. Green tree leaves will look crisper and brighter.



Increasing the **[Contrast]** will make the filter effect more pronounced.

### Toning Effect

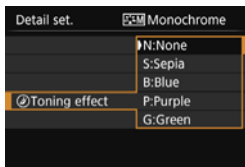

By applying a toning effect, you can create a monochrome image in that color. It can make the image look more impressive.

The following can be selected: **[N:None]**, **[S:Sepia]**, **[B:Blue]**, **[P:Purple]** or **[G:Green]**.

## Registering a Picture Style ☆

You can select a base Picture Style such as [Portrait] or [Landscape], adjust its parameters as desired and register it under [User Def. 1], [User Def. 2], or [User Def. 3].

You can create multiple Picture Styles with different settings for parameters such as sharpness and contrast.

You can also adjust the parameters of a Picture Style that is registered to the camera with EOS Utility (EOS software, p.404).

### 1 Press the <▼ > button.

- ▶ The Picture Style selection screen will appear.



### 2 Select [User Def. \*].

- Select [User Def. \*], then press <INFO.>.
- ▶ The Detail setting screen will appear.



### 3 Press <SET>.

- With [Picture Style] selected, press <SET>.

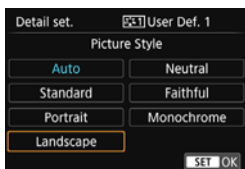

### 4 Select the base Picture Style.

- Select the base Picture Style, then press <SET>.
- To adjust the parameters of a Picture Style that is registered to the camera with EOS Utility (EOS software), select the Picture Style here.

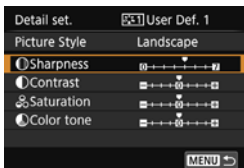

## 5 Select a parameter.

- Select a parameter such as **[Sharpness]**, then press **<SET>**.

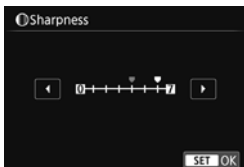

## 6 Set the parameter.

- Press the **<◀>** **<▶>** keys to adjust the parameter as desired, then press **<SET>**.  
For details, see “Customizing a Picture Style” on pages 127-129.
- Press the **<MENU>** button to register the modified Picture Style. The Picture Style selection screen will then reappear.
- ▶ The base Picture Style will be indicated on the right of **[User Def. \*]**.



- If a Picture Style has already been registered under **[User Def. \*]**, changing the base Picture Style in step 4 will nullify the parameter settings of the registered Picture Style.
- If you perform **[Clear all camera settings]** (p.267), Picture Styles and their parameters set under **[User Def. \*]** will be reverted to their default settings. Picture Styles registered via EOS Utility (EOS software) will have only their modified parameters reverted to their default settings.



- To shoot with a registered Picture Style, follow step 2 on page 125 to select **[User Def. \*]**, then shoot.
- Regarding the procedure to register a Picture Style file to the camera, refer to the EOS Utility Instruction Manual (p.406).

## WB: Matching the Light Source ☆

The function adjusting the color tone so that white objects look white in the picture is called white balance (WB). Normally, the [AWB] (Auto) setting will obtain the correct white balance. If natural-looking colors cannot be obtained with [AWB], you can select the white balance to match the light source or set it manually by shooting a white object.



### 1 Press the <▲ WB> button.

- ▶ [White balance] will appear.

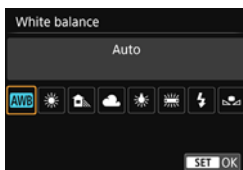

### 2 Select a white balance setting.

- Select the desired setting, then press <SET>.
- The "Approx. \*\*\*\*K" (K: Kelvin) displayed for the white balance settings <☀>, <🏠>, <☁>, <☀> or <☀> is the respective color temperature.

## Custom White Balance

Custom white balance enables you to manually set the white balance for a specific light source for better accuracy. Perform this procedure under the actual light source to be used.



### 1 Shoot a white object.

- Look through the viewfinder and aim the entire dotted line box (shown in the illustration) over a plain, white object.
- Focus manually and shoot with the standard exposure set for the white object.
- You can use any white balance setting.

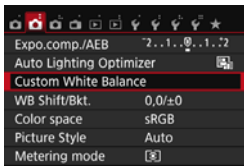

## 2 Select [Custom White Balance].

- Under the [**2**] tab, select [**Custom White Balance**], then press <SET>.
- ▶ The custom white balance selection screen will appear.



## 3 Import the white balance data.

- Select the image that was captured in step 1, then press <SET>.
- ▶ On the dialog screen that appears, select [**OK**] and the data will be imported.
- When the menu reappears, press the <MENU> button to exit the menu.



## 4 Select [**Custom**].

- Press the <▲ WB> button.
- Select [**Custom**], then press <SET>.



- If the exposure obtained in step 1 differs greatly from the standard exposure, a correct white balance may not be obtained.
- In step 3, the following images cannot be selected: Images captured while the Picture Style was set to [**Monochrome**] (p.126), images processed with a Creative filter, cropped images, and images taken with another camera.



- Instead of a white object, a gray chart or 18% gray reflector (commercially available) can produce a more accurate white balance.
- The personal white balance registered with EOS Utility (EOS software, p.404) will be registered under [**Custom**]. If you perform step 3, the data for the registered personal white balance will be erased.

## WB +/- Adjusting the Color Tone for the Light Source ☆

You can correct the white balance that is set. This adjustment will have the same effect as using a commercially-available color temperature conversion filter or color compensating filter. Each color can be corrected to one of nine levels.

This function is for advanced users who are familiar with using color temperature conversion or color compensating filters.

### White Balance Correction

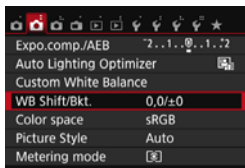

#### 1 Select [WB Shift/Bkt.].

- Under the [CAMERA 2] tab, select [WB Shift/Bkt.], then press <SET>.
- The WB correction/WB bracketing screen will appear.

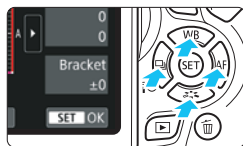

#### 2 Set the white balance correction.

- Press the <◇> cross keys to move the “■” mark to the appropriate position.
- B is for blue, A for amber, M for magenta, and G for green. The image's color balance will be adjusted towards the color in the direction of the move.
- On the upper right, “Shift” indicates the direction and correction amount, respectively.
- Pressing the <⏏> button will cancel all the [WB Shift/Bkt.] settings.
- Press <SET> to exit the setting and return to the menu.

Sample setting: A2, G1

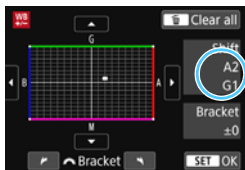

- When the white balance is corrected, <WB +/-> will be displayed in the viewfinder and on the LCD monitor.
- One level of the blue/amber correction is equivalent to approx. 5 mireds of a color temperature conversion filter. (Mired: Measuring unit indicating the density of a color temperature conversion filter.)

## White Balance Auto Bracketing

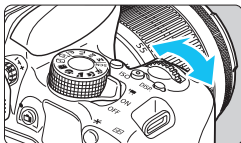

With just one shot, three images with different color tones can be recorded simultaneously. Based on the color temperature of the current white balance setting, the image will be bracketed with a blue/amber bias or magenta/green bias. This is called white balance bracketing (WB Bkt.). White balance bracketing is possible up to  $\pm 3$  levels in single-level increments.

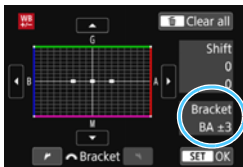

B/A bias  $\pm 3$  levels





### Set the white balance bracketing amount.

- In step 2 for “White Balance Correction”, when you turn the  dial, the “■” mark on the screen will change to “■■■” (3 points). Turning the dial to the right sets the B/A bracketing, and turning it to the left sets the M/G bracketing.
- ▶ On the right, “Bracket” indicates the bracketing direction and correction amount.
- Pressing the  button will cancel all the [WB Shift/Bkt.] settings.
- Press  to exit the setting and return to the menu.

### Bracketing Sequence

The images will be bracketed in the following sequence: 1. Standard white balance, 2. Blue (B) bias, and 3. Amber (A) bias, or 1. Standard white balance, 2. Magenta (M) bias, and 3. Green (G) bias.

 During WB bracketing, the maximum burst for continuous shooting will be lower and the number of possible shots will also decrease to approx. one-third the normal number.

-  ● You can also set white balance correction and AEB together with white balance bracketing. If you set AEB in combination with white balance bracketing, a total of nine images will be recorded for a single shot.
- Since three images are recorded for one shot, it takes longer to record the image on the card.
- During Live View shooting or movie shooting, the white balance icon will blink.
- “Bkt” stands for bracketing.

## MENU Auto Correction of Brightness and Contrast ☆

If the image comes out dark or the contrast is low, the brightness and contrast can be corrected automatically. This function is called Auto Lighting Optimizer. The default setting is [Standard]. With JPEG images, the correction is applied when the image is captured.

In Basic Zone modes, [Standard] is set automatically.

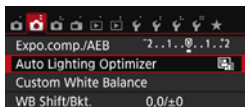

### 1 Select [Auto Lighting Optimizer].

- Under the [CAMERA] tab, select [Auto Lighting Optimizer], then press <SET>.

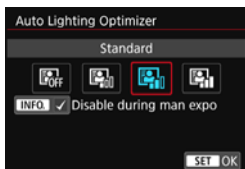

### 2 Select the setting.

- Select the desired setting, then press <SET>.

### 3 Take the picture.

- The image will be recorded with the brightness and contrast corrected if necessary.

- Under [4: Custom Functions (C.Fn)], if [3: Highlight tone priority] is set to [1: Enable], [Auto Lighting Optimizer] will be set automatically to [Disable].
- If a setting other than [Disable] is set and you use exposure compensation or flash exposure compensation to darken the exposure, the image may still come out bright. If you want a darker exposure, set this function to [Disable].
- Depending on the shooting conditions, noise may increase.

In step 2, if you press the <INFO.> button and uncheck [✓] the [Disable during man expo] setting, the Auto Lighting Optimizer can also be set in the <M> mode.



## MENU Setting Noise Reduction ☆

### High ISO Speed Noise Reduction

This function reduces the noise generated in the image. Although noise reduction is applied at all ISO speeds, it is particularly effective at high ISO speeds. At low ISO speeds, the noise in the darker parts of the image (shadow areas) is further reduced. Change the setting to suit the noise level.

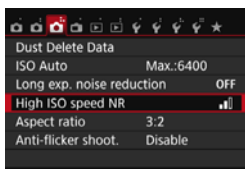

#### 1 Select [High ISO speed NR].

- Under the [CAMERA] tab, select [High ISO speed NR], then press <SET>.

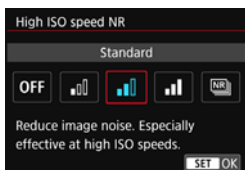

#### 2 Set the level.

- Select the desired noise reduction level, then press <SET>.

#### • [NR]: Multi Shot Noise Reduction

This applies noise reduction with higher image quality than [High]. For a single photo, four shots are taken continuously and aligned and merged automatically into a single JPEG image.

#### 3 Take the picture.

- The image will be recorded with noise reduction applied.



If you play back or directly print a RAW+L or RAW image with the camera, the effect of the high ISO speed noise reduction may look minimal. Check the noise reduction effect or print noise-reduced images with Digital Photo Professional (EOS software, p.404).

## When [Multi Shot Noise Reduction] is Set

- If there is significant misalignment in the image due to camera shake, the noise reduction effect may be minimal.
- If you are handholding the camera, keep it steady to prevent camera shake. Using a tripod is recommended.
- If you shoot a moving subject, the moving subject may leave afterimages.
- The image alignment may not function properly with repetitive patterns (lattice, stripes, etc.) or flat, single-tone images.
- If the subject's brightness changes as the four consecutive shots are taken, irregular exposure in the image may result.
- It takes some time to record images to the card since noise reduction is applied and the images are merged after shooting. During the processing of the images, "BUSY" will be displayed, and you cannot take another picture until the processing is completed.
- **RAW + L** or **RAW** cannot be selected. AEB and WB bracketing cannot be used. [**3: Long exp. noise reduction**] cannot be set. If any of these has already been selected or set, [**Multi Shot Noise Reduction**] cannot be set.
- The [**Distortion**] setting will be set automatically to [**Disable**].
- Flash shooting is not possible. The AF-assist beam will be emitted according to the [**4: Custom Functions (C.Fn)**]'s [**4: AF-assist beam firing**] setting.
- You cannot set [**Multi Shot Noise Reduction**] for bulb exposures.
- If you turn off the power, change the shooting mode to a Basic Zone mode, shoot a bulb exposure, or shoot a movie, the setting will automatically be changed to [**Standard**].
- [**3: Dust Delete Data**] cannot be set.

## Long Exposure Noise Reduction

Noise reduction is possible with images exposed for 1 sec. or longer.

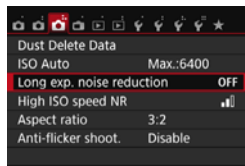

### 1 Select [Long exp. noise reduction].

- Under the [**3**] tab, select [**Long exp. noise reduction**], then press **<SET>**.

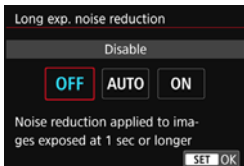

## 2 Set the desired setting.

- Select the desired setting, then press < **SET** >.

### • [Auto]

For exposures of 1 sec. or longer, noise reduction is performed automatically if noise typical of long exposures is detected. This [Auto] setting is effective in most cases.

### • [Enable]

Noise reduction is performed for all exposures of 1 sec. or longer. The [Enable] setting may reduce noise that cannot be detected with the [Auto] setting.

## 3 Take the picture.

- The image will be recorded with noise reduction applied.



- With [Auto] and [Enable], the noise reduction process after the picture is taken may take the same amount of time as that for the exposure. You cannot take another picture until the noise reduction process is completed.
- Images taken at ISO 1600 or higher may look grainier with the [Enable] setting than with the [Disable] or [Auto] setting.
- With [Auto] and [Enable], if a long exposure is shot with the Live View image displayed, "BUSY" will be displayed during the noise reduction process. The Live View display will not appear until the noise reduction is completed. (You cannot take another picture.)

## MENU Correction of Lens Peripheral Illumination and Aberrations

Peripheral light fall-off is a phenomenon that makes the image corners look darker due to the lens characteristics. Color fringing along subject outlines is called chromatic aberration. And image distortion due to lens characteristics is called distortion. These lens aberrations and light fall-off can be corrected. By default, Peripheral illumination and Chromatic aberration correction are set to **[Enable]**, and Distortion correction is set to **[Disable]**.

If **[Cannot correct - no data]** is displayed, see “Lens Correction Data” on page 142.

### Peripheral Illumination Correction

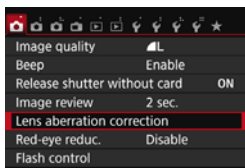

#### 1 Select **[Lens aberration correction]**.

- Under the [**1**] tab, select **[Lens aberration correction]**, then press **<SET>**.

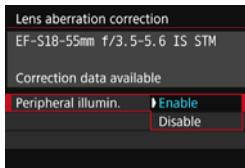

#### 2 Select the setting.

- Check that **[Correction data available]** is displayed for the attached lens.
- Select **[Peripheral illumin.]**, then press **<SET>**.
- Select **[Enable]**, then press **<SET>**.

#### 3 Take the picture.

- The image will be recorded with the peripheral illumination corrected.

**!** Depending on shooting conditions, noise may appear on the image periphery.

- The correction amount applied will be lower than the maximum correction amount settable with Digital Photo Professional (EOS software, p.404).
- The higher the ISO speed, the lower the correction amount will be.

## Chromatic Aberration Correction

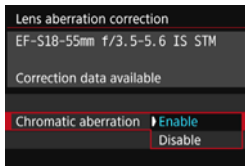

### 1 Select the setting.

- Check that [**Correction data available**] is displayed for the attached lens.
- Select [**Chromatic aberration**], then press <SET>.
- Select [**Enable**], then press <SET>.

### 2 Take the picture.

- The image will be recorded with the chromatic aberration corrected.

## Distortion Correction

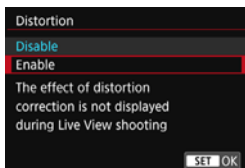



### 1 Select the setting.

- Check that [**Correction data available**] is displayed for the attached lens.
- Select [**Distortion**], then press <SET>.
- Select [**Enable**], then press <SET>.

### 2 Take the picture.

- The image will be recorded with the distortion corrected.

- 
  - When distortion correction is enabled, the camera records an image range narrower than the one seen through the viewfinder. (Image periphery will be slightly cropped and resolution slightly lowered.)
  - Distortion correction will be reflected in the captured image, but not in the viewfinder or Live View image during shooting.
  - If you set [**Distortion**] to [**Enable**], the continuous shooting speed will decrease.
  - Distortion correction cannot be set in the <  > or <  > mode, when shooting a movie, or when Multi Shot Noise Reduction is set.
  - Dust Delete Data (p.272) will not be appended to images recorded with distortion correction enabled.

## Lens Correction Data

The camera already contains data for lens peripheral illumination correction, chromatic aberration correction, and distortion correction for approx. 30 lenses. If you select [**Enable**], the peripheral illumination correction, chromatic aberration correction, and distortion correction will be applied automatically for any lens whose correction data is registered in the camera.

With EOS Utility (EOS software), you can check which lenses have their correction data registered in the camera. You can also register the correction data for unregistered lenses. For details, refer to the EOS Utility Instruction Manual (p.406).

For lenses incorporating the correction data, it is not necessary to register the correction data to the camera.



### Cautions for Lens Correction

- Peripheral illumination correction, chromatic aberration correction, and distortion correction cannot be applied to JPEG images already taken.
- When using a non-Canon lens, setting the corrections to **[Disable]** is recommended, even if **[Correction data available]** is displayed.
- If you use the magnified view during Live View shooting, the peripheral illumination correction and chromatic aberration correction will not be reflected in the image displayed on the screen.
- The correction amount will be less if the lens used does not have distance information.



### Notes for Lens Correction

- If the effect of the correction is not visible, magnify the image after shooting and check it again.
- Corrections can be applied even when an Extender or Life-size Converter is attached.

## MENU Reducing Flicker ☆

If you shoot an image with a fast shutter speed under a light source such as fluorescent light, the blinking of the light source causes flicker and the image may be vertically unevenly exposed. If continuous shooting is used under these conditions, uneven exposures or colors across the images may result.

With anti-flicker shooting, the camera detects the frequency of the light source's blinking and takes the picture when the flicker causes less effect on exposure or color.

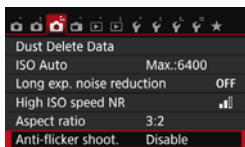

### 1 Select [Anti-flicker shoot.].

- Under the [**3**] tab, select [**Anti-flicker shoot.**], then press <SET>.

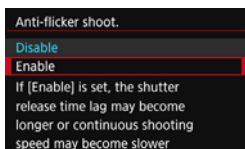

### 2 Select [Enable].

- Select [**Enable**], then press <SET>.

### 3 Take the picture.

- The image will be taken with reduced unevenness of exposure or color caused by the flicker.

- When [**Enable**] is set and you shoot under a flickering light source, the shutter-release time lag may become slightly longer. Also, the continuous shooting speed may become slightly slower, and the shooting interval may become irregular.
- This function does not work with Live View shooting and movie shooting.
- In the <P> or <Av> mode, if the shutter speed changes during continuous shooting or if you shoot multiple shots of the same scene at different shutter speeds, the color tone may be inconsistent. To avoid inconsistent color tones, use the <Tv> or <M> mode at a fixed shutter speed.
- The color tone of images shot when [**Anti-flicker shoot.**] is set to [**Enable**] may look different from when [**Disable**] is set.
- Flicker at a frequency other than 100 Hz or 120 Hz cannot be detected.





- Under [**4: Custom Functions (C.Fn)**], if you set [**9: Mirror lockup**] to [**1: Enable**], the [**Anti-flicker shoot.**] setting will automatically switch to [**Disable**].
- If the subject is against a dark background or if there is a bright light in the image, flicker may not be detected.
- Under certain special types of lighting, the camera may not be able to reduce the effects of the flicker even when < **Flicker!** > is displayed.
- Depending on the light source, flicker may not be detected properly.
- If you recompose a shot, < **Flicker!** > may appear and disappear intermittently.
- Depending on the light sources or shooting conditions, expected result may not be obtained even if you use this function.



- Taking test shots is recommended.
- If < **Flicker!** > is not displayed in the viewfinder, under [**2: Viewfinder display**], set [**Flicker detection**] to [**Show**] (p.63). When the camera reduces the effects of the flicker when you shoot, < **Flicker!** > will light. Under a light source which does not flicker, or if no flicker is detected, < **Flicker!** > will not be displayed.
- If [**Flicker detection**] is set to [**Show**] and [**Anti-flicker shoot.**] is set to [**Disable**], metering under a flickering light source will cause < **Flicker!** > to blink in the viewfinder as a warning. Setting [**Enable**] before shooting is recommended.
- In Basic Zone modes, < **Flicker!** > will not be displayed, but the effects of flicker will be reduced when you shoot.
- Anti-flicker shooting also works with flash. However, the expected result may not be obtained during wireless flash shooting.

## MENU Setting the Color Reproduction Range ☆

The range of reproducible colors is called the color space. With this camera, you can set the color space for captured images to sRGB or Adobe RGB. For normal shooting, sRGB is recommended.

In Basic Zone modes, sRGB is set automatically.

### 1 Select [Color space].

- Under the [CAMERA 2] tab, select [Color space], then press <SET>.

### 2 Set the desired color space.

- Select [sRGB] or [Adobe RGB], then press <SET>.

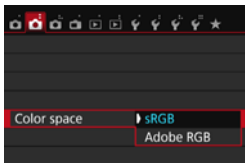

## Adobe RGB

This color space is mainly used for commercial printing and other industrial uses. This setting is not recommended if you are not familiar with image processing, Adobe RGB, and Design rule for Camera File System 2.0 (Exif 2.21 or higher). The image will look very subdued in a sRGB computer environment and with printers not compatible with Design rule for Camera File System 2.0 (Exif 2.21 or higher). Post-processing of the image with computer software will therefore be required.

- If the captured still photo was shot in the Adobe RGB color space, the first character in the file name will be an underscore “\_”.
- The ICC profile is not appended. Refer to explanations about the ICC profile in the Digital Photo Professional Instruction Manual (p.406).

# 5

## Advanced Operations

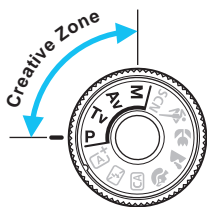

In Creative Zone modes, you can change various settings of the camera as you desire to obtain a wide variety of shooting results, by selecting the shutter speed and/or aperture, adjusting the exposure as you prefer, etc.

- The ☆ icon at the upper right of the page title indicates that the function is available only in Creative Zone modes.
- After you press the shutter button halfway and let go, the exposure values will remain displayed in the viewfinder for 4 sec. (4) by the operation of metering timer.
- For the functions settable in each shooting mode, see page 356.

### ↔ Main Dial Pointer



The pointer icon <↔> displayed together with the shutter speed, aperture setting, or exposure compensation amount indicates that you can turn the <⌚> dial to adjust the respective setting.

## P: Program AE

The camera automatically sets the shutter speed and aperture to suit the subject's brightness. This is called Program AE.

\* <P> stands for Program.

\* AE stands for Auto Exposure.



### 1 Set the Mode Dial to <P>.



### 2 Focus on the subject.

- Look through the viewfinder and aim the AF point over the subject. Then press the shutter button halfway.
- ▶ When focus is achieved, the focus indicator <●> on the viewfinder's bottom right will light up (when in One-Shot AF mode).
- ▶ The shutter speed and aperture will be set automatically and displayed in the viewfinder.



### 3 Check the display.

- A standard exposure will be obtained as long as the shutter speed and aperture display do not blink.

### 4 Take the picture.

- Compose the shot and press the shutter button completely.



## Shooting Tips

### ● Change the ISO speed. Use the built-in flash.

To match the subject and ambient lighting level, you can change the ISO speed (p.122) or use the built-in flash (p.166). In the <P> mode, the built-in flash will not fire automatically. Therefore, press the <⚡> (flash) button to raise the built-in flash when indoors or shooting in low light.

### ● Change the program using Program shift.

After pressing the shutter button halfway, turn the <☀> dial to change the shutter speed and aperture setting combination (program). Program shift is canceled automatically after the picture is taken. Program shift is not possible with flash.



- If the “30” shutter speed and the lowest f/number blink, it indicates underexposure. Increase the ISO speed or use flash.
- If the “4000” shutter speed and the highest f/number blink, it indicates overexposure. Decrease the ISO speed.



### Differences Between <P> and <A+> (Scene Intelligent Auto)

In the <A+> mode, many functions, such as the AF operation and metering mode, are set automatically to prevent spoiled shots. The functions you can set are limited. With <P> mode, only the shutter speed and aperture are set automatically. You can freely set the AF operation, metering mode, and other functions (p.354).

## Tv: Conveying the Subject's Movement

You can either freeze the action or create motion blur with the **<Tv>** (Shutter-priority AE) mode on the Mode Dial.

\* **<Tv>** stands for Time value.



Blurred motion  
(Slow shutter speed: 1/30 sec.)



Frozen action  
(Fast shutter speed: 1/2000 sec.)



**1** Set the Mode Dial to **<Tv>**.

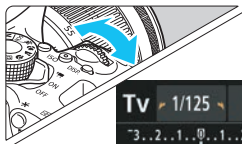

**2** Set the desired shutter speed.

- See “Shooting Tips” on the next page for advice on setting the shutter speed.
- Turning the  dial to the right sets a faster shutter speed, and turning it to the left sets a slower one.



**3** Take the picture.

- When you focus and press the shutter button completely, the picture will be taken at the selected shutter speed.



### Shutter Speed Display

The LCD monitor displays the shutter speed as a fraction. However, the viewfinder displays only the denominator. “0”5” indicates 0.5 sec. and “15”” is 15 sec.



## Shooting Tips

- **To freeze the motion of a fast-moving subject**  
Use a fast shutter speed such as 1/4000 sec. to 1/500 sec.
- **To blur a running child or animal and convey an impression of motion**  
Use a medium shutter speed such as 1/250 sec. to 1/30 sec. Follow the moving subject through the viewfinder and press the shutter button to take the picture. If you use a telephoto lens, hold it steady to prevent camera shake.
- **To blur a flowing river or fountain**  
Use a slow shutter speed of 1/30 sec. or slower. Use a tripod to prevent hand-held camera shake.
- **Set the shutter speed so that the aperture display does not blink.**

If you press the shutter button halfway and change the shutter speed while the aperture is displayed, the aperture display will also change to maintain the same exposure (amount of light reaching the image sensor). If you exceed the adjustable aperture range, the aperture display will blink to indicate that the standard exposure cannot be obtained.

If the exposure will be too dark, the maximum aperture (lowest f/number) will blink. If this happens, turn the  dial to the left to set a slower shutter speed or increase the ISO speed.

If the exposure will be too bright, the minimum aperture (highest f/number) will blink. If this happens, turn the  dial to the right to set a faster shutter speed or decrease the ISO speed.



## ⚡ Using the Built-in Flash

To obtain a correct flash exposure, the flash output will be set automatically (autoflash exposure) to match the automatically-set aperture. The shutter speed can be set from 1/200 sec. to 30 sec.

# Av: Changing the Depth of Field

To blur the background or to make everything near and far look sharp, set the Mode Dial to <Av> (Aperture-priority AE) to adjust the depth of field (range of acceptable focus).

\* <Av> stands for Aperture value, which is the size of the diaphragm hole inside the lens.



Blurred background  
(With a low aperture f/number: f/5.6)



Sharp foreground and background  
(With a high aperture f/number: f/32)



## 1 Set the Mode Dial to <Av>.

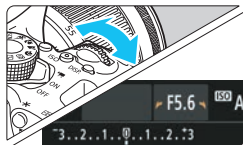

## 2 Set the desired aperture.

- The higher the f/number, the wider the depth of field where sharper focus is obtained in both the foreground and background.
- Turning the <aperture> dial to the right will set a higher f/number (smaller aperture opening), and turning it to the left will set a lower f/number (larger aperture opening).



## 3 Take the picture.

- Focus and press the shutter button completely. The picture will be taken with the selected aperture.



### Aperture Display

The higher the f/number, the smaller the aperture opening will be. The f/number displayed will differ depending on the lens. If no lens is attached to the camera, "00" will be displayed for the aperture.





## Shooting Tips

- **When using an aperture with a high f/number or shooting in low light scenes, note that camera shake can occur.**

A higher aperture f/number will make the shutter speed slower.

Under low light, the shutter speed can be as long as 30 sec. In such cases, increase the ISO speed and hold the camera steady or use a tripod.

- **The depth of field depends not only on the aperture, but also on the lens and on the subject distance.**

Since wide-angle lenses have a wide depth of field (range of acceptable focus in front of and behind the point of focus), you need not set a high aperture f/number to obtain a sharp picture from the foreground to the background. On the other hand, a telephoto lens has a narrow depth of field.

And the closer the subject, the narrower the depth of field. A farther subject will have a wider depth of field.

- **Set the aperture so that the shutter speed display does not blink.**

If you press the shutter button halfway and change the aperture while the shutter speed is displayed, the shutter speed display will also change to maintain the same exposure (amount of light reaching the image sensor). If you exceed the adjustable shutter speed range, the shutter speed display will blink to indicate that the standard exposure cannot be obtained.

If the picture will be too dark, the “30” (30 sec.) shutter speed display will blink. If this happens, turn the <  > dial to the left to set a lower f/number or increase the ISO speed.

If the picture will be too bright, the “4000” (1/4000 sec.) shutter speed display will blink. If this happens, turn the <  > dial to the right to set a higher f/number or decrease the ISO speed.



## ⚡ Using the Built-in Flash

To obtain a correct flash exposure, the flash output will be set automatically to match the set aperture (autoflash exposure). The shutter speed will be set automatically between 1/200 sec. - 30 sec. to suit the scene's brightness.

In low light, the main subject is exposed with the auto flash metering, and the background is exposed with a slow shutter speed set automatically. Both the subject and background look properly exposed with a touch of atmosphere (automatic slow-speed flash sync). If you are handholding the camera, keep it steady to prevent camera shake. Using a tripod is recommended.

To prevent a slow shutter speed, under [**📷 1: Flash control**], set [**Flash sync. speed in Av mode**] to [**1/200-1/60sec. auto**] or [**1/200 sec. (fixed)**] (p.174).

## Depth-of-Field Preview ☆

The aperture opening (diaphragm) changes only at the moment when the picture is taken. Otherwise, the aperture remains fully open. Therefore, when you look at the scene through the viewfinder or on the LCD monitor, the depth of field will look narrow.

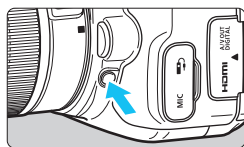

Press the depth-of-field preview button to stop down the lens to the current aperture setting, and check the depth of field (range of acceptable focus).

 While looking at the Live View image (p.192) and holding down the depth-of-field preview button, you can see how the range of acceptable focus will change as you adjust the aperture.

# M: Manual Exposure

You can set both the shutter speed and aperture manually as desired. While referring to the exposure level indicator in the viewfinder, you can set the exposure as desired. This method is called manual exposure.

\* <M> stands for Manual.



## 1 Set the Mode Dial to <M>.

## 2 Set the ISO speed (p.122).

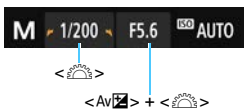

## 3 Set the shutter speed and aperture.

- To set the shutter speed, turn the <G> dial.
- To set the aperture, hold down the <Av/□> button and turn the <G> dial.

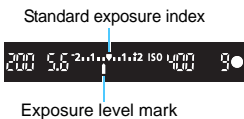

## 4 Focus on the subject.

- Press the shutter button halfway.
- The exposure setting will be displayed in the viewfinder.
- The exposure level mark <▲> indicates how far the current exposure level is from the standard exposure level.

## 5 Set the exposure and take the picture.

- Check the exposure level indicator and set the desired shutter speed and aperture.
- If the exposure level exceeds ±2 stops from the standard exposure, the end of the exposure level indicator will display <◀> or <▶> in the viewfinder. (On the LCD monitor, if the exposure level exceeds ±3 stops, <◀◀> or <▶▶> will be displayed.)



If ISO Auto is set, the ISO speed setting will change to suit the shutter speed and aperture in order to obtain a standard exposure. Therefore, you may not obtain the desired exposure effect.



Under [CAMERA 2: Auto Lighting Optimizer], if the checkmark <✓> for [Disable during man expo] is removed, the Auto Lighting Optimizer can be set even in the <M> mode (p.136).

- When ISO Auto is set, you can press the <★> button to lock the ISO speed.
- If you press the <★> button and recompose the shot, you can see the exposure level difference on the exposure level indicator compared to when the <★> button was pressed.

### ⚡ Using the Built-in Flash

To obtain a correct flash exposure, the flash output will be set automatically (autoflash exposure) to match the manually-set aperture. The shutter speed can be set from 1/200 sec. to 30 sec or bulb.

### BULB: Bulb Exposures

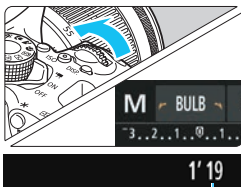

Elapsed exposure time

A bulb exposure keeps the shutter open for as long as you hold down the shutter button. It can be used to shoot fireworks and other subjects requiring long exposures.

In step 3 on the preceding page, turn the <☀> dial to the left to set <BULB>. The elapsed exposure time will be displayed on the LCD monitor.

- Do not point the camera toward an intense light source, such as the sun or an intense artificial light source. Doing so may damage the image sensor or the camera's internal components.
- Since bulb exposures produce more noise than usual, the image may look slightly grainy.
- You can reduce the noise due to long exposures by setting [**3: Long exp. noise reduction**] to [Auto] or [Enable] (p.138).

- For bulb exposures, using a tripod and a remote switch (sold separately, p.351) is recommended.
- You can also use a remote controller (sold separately, p.350) for bulb shooting. When you press the remote controller's transmit button, the bulb exposure will start immediately or 2 sec. later. Press the button again to stop the bulb exposure.
- You can turn off the elapsed exposure time display by pressing the <DISP.> button.

## Changing the Metering Mode ★

Four methods (metering modes) to measure the subject's brightness are provided. Normally, evaluative metering is recommended. In Basic Zone modes, metering mode is set automatically.

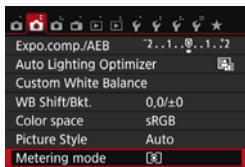

### 1 Select [Metering mode].

- Under the [ 2] tab, select [Metering mode], then press <SET>.

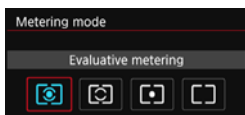

### 2 Set the metering mode.

- Select the desired metering mode, then press <SET>.

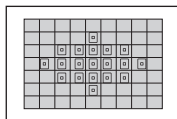

#### Evaluative metering

General-purpose metering mode suited even for backlit subjects. The camera sets the exposure automatically to suit the scene.

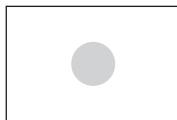

#### Partial metering

Effective where there are much brighter lights around the subject due to backlight, etc. The gray area in the left figure is where the brightness is metered to obtain the standard exposure.

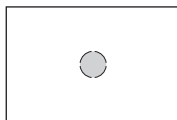

#### Spot metering

Effective when metering a specific part of the subject or scene. The gray area in the left figure is where the brightness is metered to obtain the standard exposure. This metering mode is for advanced users.



☒ **Center-weighted average metering**

The brightness is metered at the image center and then averaged for the entire scene. This metering mode is for advanced users.

☒ With ☒ (Evaluative metering), the exposure setting will be locked when you press the shutter button halfway and focus is achieved. In the ☒ (Partial metering), ☒ (Spot metering), and ☒ (Center-weighted average metering) modes, the exposure is set at the moment the picture is taken. (Pressing the shutter button halfway does not lock the exposure.)

# Setting Exposure Compensation ☆

Set exposure compensation if the exposure (without flash) does not come out as desired. This feature can be used in Creative Zone modes (except <M>). You can set the exposure compensation up to  $\pm 5$  stops in 1/3-stop increments.

## 1 Check the exposure level indicator.

- Press the shutter button halfway (☉4) and check the exposure level indicator in the viewfinder or on the LCD monitor.

Increased exposure  
for a brighter image



## 2 Set the compensation amount.

- If the exposure is too dark, hold down the <Av/☒> button and turn the <☀> dial to the right (for increased exposure). If the exposure is too bright, hold down the <Av/☒> button and turn the <☀> dial to the left (for decreased exposure).

Decreased exposure  
for a darker image



## 3 Take the picture.

- To cancel the exposure compensation, set the exposure compensation amount back to <0>.

⚠ If [☑2: Auto Lighting Optimizer] (p.136) is set to any setting other than [Disable], the image may still look bright even if a decreased exposure compensation for a darker image is set.



- The exposure compensation amount will remain in effect even after you set the power switch to <OFF>.
- The exposure compensation amount displayed in the viewfinder goes up to only  $\pm 2$  stops. If the exposure compensation amount exceeds  $\pm 2$  stops, the end of the exposure level indicator will display <◀> or <▶>.
- If you want to set exposure compensation exceeding  $\pm 2$  stops, setting it with [☑2: Expo.comp./AEB] (p.160) or with the Quick Control screen (p.51) is recommended.

## MENU Auto Exposure Bracketing ☆

This feature takes exposure compensation a step further by varying the exposure automatically (up to  $\pm 2$  stops in 1/3-stop increments) with three shots as shown below. You can then choose the best exposure. This is called AEB (Auto Exposure Bracketing).



Standard exposure



Darker exposure  
(Decreased exposure)



Brighter exposure  
(Increased exposure)

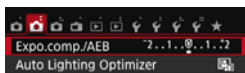

### 1 Select [Expo.comp./AEB].

- Under the [CAMERA] tab, select [Expo.comp./AEB], then press <SET>.

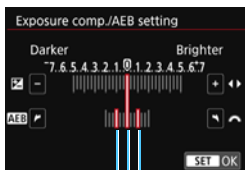

AEB range

### 2 Set the AEB range.

- Turn the <DIAL> dial to set the AEB range.
- Press the <LEFT> <RIGHT> keys to set the exposure compensation amount. If AEB is combined with exposure compensation, AEB will be applied centering on level of exposure compensation.
- Press <SET> to set it.
- When you press the <MENU> button to exit the menu, the AEB range will be displayed on the LCD monitor.



### 3 Take the picture.

- Focus and press the shutter button completely. The three bracketed shots will be taken in this sequence: standard exposure, decreased exposure, and increased exposure.



## Canceling AEB

- Follow steps 1 and 2 to turn off the AEB range display (set to 0).
- The AEB setting will also be canceled automatically if the power switch is set to <OFF>, flash recycling is completed, etc.



## Shooting Tips

### ● Using AEB with continuous shooting

If the drive mode is set to <C> or <C5> (p.112) and you press the shutter button completely, the three bracketed shots will be taken continuously in this sequence: standard exposure, decreased exposure, and increased exposure. The shooting will then stop automatically.

### ● Using AEB with single shooting (□/□5)

Press the shutter button three times to take the three bracketed shots. The three bracketed shots will be taken in the following sequence: standard exposure, decreased exposure, and increased exposure.

### ● Using AEB with the self-timer or a remote controller (sold separately)

With the self-timer or a remote control shooting (<T> or <T2>), you can take three continuous shots after a 10-sec. or 2-sec. delay. With <Tc> (p.114) set, the number of continuous shots will be three times the number set.



- During AEB, <AEB> in the viewfinder and AEB range will blink.
- AEB cannot be used with flash, [Multi Shot Noise Reduction], Creative filters, or bulb exposures.
- If [2: Auto Lighting Optimizer] (p.136) is set to any setting other than [Disable], the effect of AEB may be reduced.

## ✳ Locking the Exposure ☆

You can lock the exposure when the area of focus is to be different from the exposure metering area or when you want to take multiple shots at the same exposure setting. Press the <✳> button to lock the exposure, then recompose and take the picture. This is called AE lock. It is effective for backlit subjects, etc.

### 1 Focus on the subject.

- Press the shutter button halfway.
- ▶ The exposure setting will be displayed.

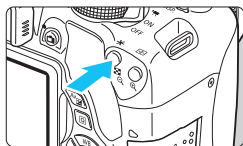

### 2 Press the <✳> button. (☉4)

- ▶ The <✳> icon lights up in the viewfinder to indicate that the exposure setting is locked (AE lock).
- Each time you press the <✳> button, the current autoexposure setting is locked.

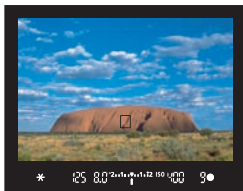

### 3 Recompose and take the picture.

- If you want to maintain the AE lock while taking more shots, hold down the <✳> button and press the shutter button to take another shot.

## AE Lock Effects

Metering Mode (p.157)	AF Point Selection Method (p.106)	
	Automatic Selection	Manual Selection
*	AE lock is applied at the AF point that achieved focus.	AE lock is applied at the selected AF point.
	AE lock is applied to the center AF point.	

\* When the lens's focus mode switch is set to <MF>, AE lock is applied to the center AF point.

AE lock is not possible with bulb exposures.

# Mirror Lockup to Reduce Camera Shake <sup>☆</sup>

Camera vibrations caused by the mirror's reflex action is called "mirror shock". Mirror lockup can reduce the blur caused by camera vibrations. This is useful especially when you are using a super telephoto lens or shooting closeups (macro photography).

**Mirror lockup is enabled by setting [9: Mirror lockup] to [1: Enable] in [4: Custom Functions (C.Fn)] (p.342).**

---

## 1 Focus on the subject, then press the shutter button completely.

- ▶ The mirror will swing up.

## 2 Press the shutter button completely again.

- ▶ The picture is taken and the mirror goes back down.
- After taking the picture, set [9: Mirror lockup] to [0: Disable].



### Shooting Tips





#### ● Using the self-timer <1>, <2> with mirror lockup

When you press the shutter button completely, the mirror locks up. The picture will be then taken 10 sec. or 2 sec. later.

#### ● Remote control shooting

Since you do not touch the camera when the picture is taken, remote control shooting together with mirror lockup can further reduce camera shake (p.350). With Remote Controller RC-6 (sold separately) set to a 2-sec. delay, press the transmit button to lock up the mirror, and the picture will be taken 2 sec. after the mirror lockup.

- Do not point the camera toward an intense light source, such as the sun or an intense artificial light source. Doing so may damage the image sensor or the camera's internal components.
- In very bright light, such as at the beach or a ski slope on a sunny day, take the picture promptly after mirror lockup is stabilized.
- If you use the self-timer and bulb exposure in combination with a mirror lockup, keep pressing the shutter button completely (self-timer delay time + bulb exposure time). If you let go of the shutter button during the self-timer countdown, there will be a shutter-release sound, but no picture will be taken.
- During mirror lockup, shooting function settings and menu operations, etc. are disabled.
- If you use flash, the red-eye reduction lamp will not light up (p.167).

- Even if you set the drive mode to , , or , the camera will still shoot in single shooting mode.
- When [3: High ISO speed NR] is set to [**Multi Shot Noise Reduction**], four continuous shots will be taken for the single picture regardless of the [**9: Mirror lockup**] setting.
- If 30 sec. elapse after the mirror is locked up, it will go back down automatically. Pressing the shutter button completely again locks up the mirror again.

# 6

## Flash Photography

This chapter explains how to shoot with built-in flash and external Speedlites (EX-series, sold separately), how to set flash settings with the camera's menu screen, and how to use the built-in flash for wireless flash shooting.



- Flash cannot be used with movie shooting. It will not fire.
- AEB cannot be used with flash.

## ⚡ Using the Built-in Flash

In indoor, low light, or backlit conditions in daylight, just raise the built-in flash and press the shutter button to take flash pictures. In the <P> mode, the shutter speed (1/60 sec. - 1/200 sec.) will be set automatically to prevent camera shake.

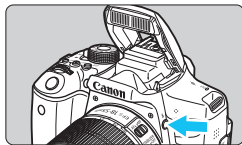

### 1 Press the <⚡> button.

- In Creative Zone modes, you can press the <⚡> button anytime to take flash pictures.
- While the flash is recycling, “⚡buSY” is displayed in the viewfinder, and [BUSY⚡] is displayed on the LCD monitor.



### 2 Press the shutter button halfway.

- In the bottom left of the viewfinder, check that the <⚡> icon is lit.

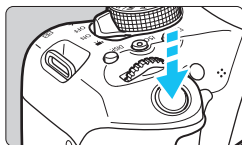

### 3 Take the picture.

- When focus is achieved and you press the shutter button completely, the flash will fire for the picture.

## Effective Range of Built-in Flash

(Approx. in meters/feet)

ISO Speed (p.122)	EF-S18-55mm f/3.5-5.6 IS STM, EF-S18-135mm f/3.5-5.6 IS STM, EF-S55-250mm f/4-5.6 IS STM		
	Wide Angle		Telephoto
	f/3.5	f/4	f/5.6
ISO 100	1 - 3.4 / 3.3 - 11.2	1 - 3 / 3.3 - 9.8	1 - 2.1 / 3.3 - 6.9
ISO 400	1 - 6.9 / 3.3 - 22.6	1 - 6 / 3.3 - 19.7	1 - 4.3 / 3.3 - 14.1
ISO 1600	1.7 - 13.7 / 5.6 - 44.9	1.5 - 12 / 4.9 - 39.4	1.1 - 8.6 / 3.6 - 28.2
ISO 6400	3.4 - 27.4 / 11.2 - 89.9	3 - 24 / 9.8 - 78.7	2.1 - 17.1 / 6.9 - 56.1

\* When a high ISO speed is set and focusing distance is long, appropriate exposure may not be obtained depending on the subject conditions, etc.

## 💡 Shooting Tips

- **In bright light, decrease the ISO speed.**  
If the exposure setting in the viewfinder blinks, decrease the ISO speed.
- **Detach the lens hood. Do not get too close to the subject.**  
If the lens has a hood attached or you are too close to the subject, the bottom of the picture may look dark due to the obstructed flash. For important shots, check the image on the LCD monitor to make sure the flash exposure looks natural (not dark at the bottom).

## MENU Red-eye Reduction

Using the red-eye reduction lamp before taking a flash picture can reduce red eye.

Red-eye reduction will function in any shooting mode except <[📷]>, <[🏠]>, <[👤]>, <[📷]>, or <[📷]>.

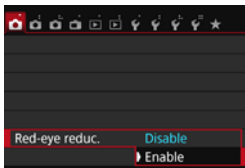

- Under the [**📷1**] tab, select [**Red-eye reduc.**], then press <[SET]>.
- Select [**Enable**], then press <[SET]>.
- For flash photography, when you press the shutter button halfway, the red-eye reduction lamp will light up. Then when you press the shutter button completely, the picture will be taken.



- The red-eye reduction feature is more effective when the subject looks at the red-eye reduction lamp, when the room is well lit, or when you are close to the subject.
- When you press the shutter button halfway, the scale display on the bottom of the viewfinder will shrink and turn off. For best results, take the picture after this scale display turns off.
- The effectiveness of red-eye reduction varies depending on the individual subject.



## ⚡ Flash Exposure Compensation ☆

Set flash exposure compensation if the flash exposure of the subject does not come out as desired. You can set the exposure compensation up to  $\pm 2$  stops in 1/3-stop increments.

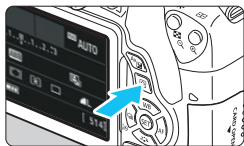

### 1 Press the <Q> button (ⓐ10).

- ▶ The Quick Control screen will appear (p.51).



### 2 Select [⚡].

- Press the <⬆> cross keys to select [⚡\*].
- ▶ [Flash exposure comp.] will be displayed at the bottom.



### 3 Set the exposure compensation amount.

- If the exposure is too dark, turn the <⤴> dial to the right (for increased exposure).  
If the exposure is too bright, turn the <⤵> dial to the left (for decreased exposure).

- ▶ When you press the shutter button halfway, the <⚡> icon will appear in the viewfinder.
- **After taking the picture, cancel the flash exposure compensation by setting it back to 0.**

- ⚠ ● If [ⓐ2: Auto Lighting Optimizer] (p.136) is set to any setting other than [Disable], the image may still look bright even if a decreased flash exposure compensation is set.
- If flash exposure compensation is set with an external Speedlite (sold separately, p.171), you cannot set the flash exposure compensation with the camera (Quick Control or External flash function settings). If it is set with both the camera and Speedlite, the Speedlite's setting overrides the camera's.





- The exposure compensation amount will remain in effect even after you set the power switch to <OFF>.
- You can also set flash exposure compensation with [**Built-in flash settings**] in [**1: Flash control**] (p.176).

## ✳ Locking the Flash Exposure (FE lock) ☆

If the subject is on the side of the frame and you use flash, the subject may turn out to be too bright or dark depending on the background, etc. Use FE lock in such a case. After setting the proper flash exposure for the subject, you can recompose (put the subject toward the side) and shoot. This feature can also be used with a Canon EX-series Speedlite.

\* FE stands for Flash Exposure.

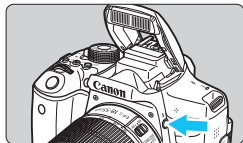

### 1 Press the <⚡> button.

- ▶ The built-in flash will be raised.
- Press the shutter button halfway and look in the viewfinder to check that the <⚡> icon is lit.



### 2 Focus on the subject.

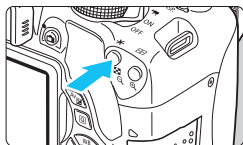

### 3 Press the <✳> button. (Ⓜ16)

- Aim the viewfinder center over the subject where you want to lock the flash exposure, then press the <✳> button.
- ▶ The flash will fire a preflash and the required flash output is calculated and retained in memory.
- ▶ In the viewfinder, "FEL" is displayed for a moment and <⚡✳> will light up.



- Each time you press the <✳> button, a preflash is fired and the required flash output is calculated and retained in memory.



## 4 Take the picture.

- Compose the shot and press the shutter button completely.
- ▶ The flash is fired, and the picture is taken.

- If the subject is too far away and beyond the effective range of the flash, the <⚡> icon will blink. Move closer to the subject and repeat steps 2 to 4.
- FE lock is not possible during Live View shooting.

## ⚡ Using an External Speedlite

### EOS-dedicated, EX-series Speedlites

**Basically operates like a built-in flash for easy operation.**

When an EX-series Speedlite (sold separately) is attached to the camera, almost all the autoflash control is done by the camera. In other words, it is like a high-output flash attached externally in place of the built-in flash.



**For detailed instructions, refer to the EX-series Speedlite's instruction manual.** This camera is a Type-A camera that can use all the features of EX-series Speedlites.



Shoe-mount Speedlites

Macro Lites



- With an EX-series Speedlite not compatible with flash function settings (p.173), only **[Flash exp. comp]** and **[E-TTL II meter.]** can be set for **[External flash func. setting]**. (**[Shutter sync.]** can also be set with certain EX-series Speedlites.)
- If flash exposure compensation is set with the external Speedlite, the flash exposure compensation icon displayed on the camera's LCD monitor will change from  to .

## Canon Speedlites Other Than the EX-series

- With an EZ/E/EG/ML/TL-series Speedlite set in TTL or A-TTL autoflash mode, the flash can be fired at full output only. Set the camera's shooting mode to <M> (manual exposure) or <Av> (aperture-priority AE) and adjust the aperture setting before shooting.
- When using a Speedlite that has manual flash mode, shoot in the manual flash mode.

## Using Non-Canon Flash Units

### Sync Speed

The camera can synchronize with compact, non-Canon flash units at 1/200 sec. or slower shutter speeds. Use a sync speed slower than 1/200 sec.

Be sure to test the flash unit beforehand to make sure it synchronizes properly with the camera.

### Cautions for Live View Shooting

A non-Canon flash will not fire during Live View shooting.

- If the camera is used with a flash unit or flash accessory dedicated to another camera brand, the camera may not operate properly and malfunction may result.
- Do not attach a high-voltage flash unit on the camera's hot shoe. It may not fire.

## MENU Setting the Flash ☆

With the built-in flash or an EX-series, external Speedlite compatible with flash function settings, you can use the camera's menu to set flash functions and the external Speedlite's Custom Functions.

**If you use an external Speedlite, attach the Speedlite to the camera and turn on the Speedlite before setting the flash functions.** For details on the external Speedlite's flash functions, refer to the Speedlite's instruction manual.

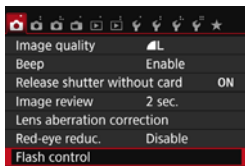

### Select [Flash control].

- Under the [ 1] tab, select [Flash control], then press <SET>.
- ▶ The Flash control screen will appear.

### [Flash firing]

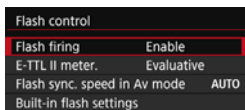

- Normally, set this to [Enable].
- If [Disable] is set, neither the built-in flash nor the external Speedlite will fire. This is useful when you want to use only the flash's AF-assist beam.

### [E-TTL II meter.]

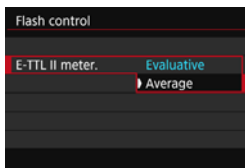

- For normal flash exposures, set this to [Evaluative].
- [Average] is for advanced users. As with an external Speedlite, the metering area is averaged. Flash exposure compensation may be necessary.



Even if [Flash firing] is set to [Disable], if focus is difficult to achieve in low light, the flash may still fire a series of flashes (AF-assist beam, p.103).

## [Flash sync. speed in Av mode]

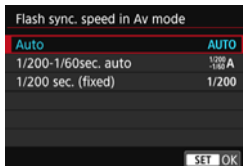

You can set the flash-sync speed for flash photography in the aperture-priority AE (**Av**) mode.

- **AUTO: Auto**

The flash sync speed is set automatically within a range of 1/200 sec. to 30 sec. to suit the scene's brightness. High-speed sync is also possible.

- <sup>1/200</sup>/<sub>-1/60</sub> **A: 1/200-1/60 sec. auto**

Prevents a slow shutter speed from being set in low-light conditions. It is effective for preventing subject blur and camera shake. However, while the subject will be properly exposed with the flash, the background may come out dark.

- **1/200: 1/200 sec. (fixed)**

The flash-sync speed is fixed at 1/200 sec. This more effectively prevents subject blur and camera shake than with [**1/200-1/60sec. auto**]. However, in low light, the subject's background will come out darker than with [**1/200-1/60sec. auto**].

ⓘ If [**1/200-1/60sec. auto**] or [**1/200 sec. (fixed)**] is set, high-speed sync is not possible in the <**Av**> mode with the external Speedlite.

## Displaying the Flash Function Setting Screen Directly

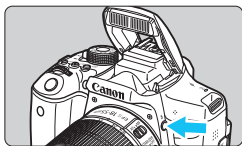

When you use the built-in flash or an external, EX-series Speedlite compatible with flash function settings, you can press the **<⚡>** button to directly display the **[Built-in flash settings]** or **[External flash func. setting]** screen without first displaying the menu screen.

### ● With built-in flash

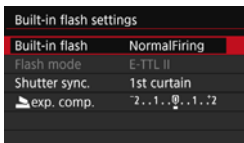

### Press the **<⚡>** button twice.

- The built-in flash will be raised.
- Press the button again to display the **[Built-in flash settings]** screen.

### ● With external Speedlite

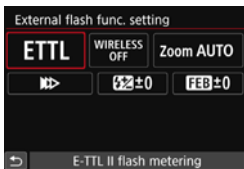

### Press the **<⚡>** button.

- With the external Speedlite turned on, press the **<⚡>** button to display the **[External flash func. setting]** screen.



- When you press the **<⚡>** button to display the flash function setting screen, you cannot set **[Flash firing]**, **[E-TTL II meter.]**, **[Flash sync. speed in Av mode]**, or **[External flash C.Fn setting]**. Set these functions with **[CAMERA 1: Flash control]** instead.
- If **[Flash firing]** is set to **[Disable]** and you press the **<⚡>** button, the **[CAMERA 1: Flash control]** screen will appear.

## [Built-in flash settings] and [External flash func. setting]

You can set the functions in the table below. The functions displayed under [External flash func. setting] vary depending on the Speedlite model.

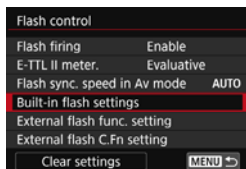

- Select [Built-in flash settings] or [External flash func. setting].
- ▶ The flash function setting screen will be displayed. With [Built-in flash settings], only the highlighted functions can be selected and set.

### Sample screen

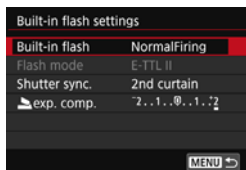

[Built-in flash settings]

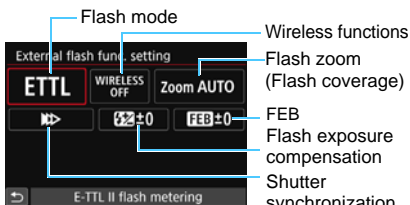

[External flash func. setting]

### Main Functions for [Built-in flash settings] and [External flash func. settings]

Function	[Built-in flash settings]			[External flash func. setting]	Page
	Normal Firing	Easy Wireless (p.182)	Custom Wireless (p.185)		
Flash mode			○	○	177
Shutter synchronization	○			○	177
FEB*				○	
Wireless functions			○	○	177
Flash exposure compensation	○	○	○	○	168
Flash ratio control			○		
Master flash firing				○	
Flash zoom*				○	

\* For [FEB] (Flash exposure bracketing) and [Flash zoom], refer to the instruction manual of a Speedlite compatible with the functions.



## ● Flash mode

When using an external Speedlite, you can select the flash mode to suit your desired flash shooting.

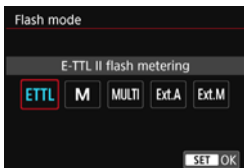

- **[E-TTL II]** is the standard mode of EX-series Speedlites for automatic flash shooting.
- **[Manual flash]** is for advanced users who want to set the **[Flash output]** (1/1 to 1/128) themselves.
- Regarding other flash modes, refer to the instruction manual of a Speedlite compatible with the functions.

## ● Shutter synchronization

Normally, set this to **[1st curtain]** so that the flash fires immediately after the exposure starts.

If **[2nd curtain]** is set, the flash will fire right before the shutter closes.

When this is combined with a slow shutter speed, you can create a trail of light such as from car headlights at night with a more natural feel.

With E-TTL II (auto flash exposure), two flashes will be fired: once when you press the shutter button completely, and once immediately before the exposure ends. Also, if the shutter speed is 1/30 sec. or faster, first-curtain synchronization will be applied automatically.

If an external Speedlite is attached, you can also select **[High-speed synchronization]** ( $\downarrow_H$ ). For details, refer to the Speedlite's instruction manual.

## ● Wireless functions

When performing optical transmission wireless flash shooting using the master function of the built-in flash, see “Using Wireless Flash” on page 179. When performing wireless flash shooting with radio or optical transmission using the master function of the external Speedlite, refer to the Speedlite's instruction manual.

## ● Flash exposure compensation

See “Flash Exposure Compensation” on page 168.

## Setting the External Speedlite Custom Functions

The Custom Functions displayed under [External flash C.Fn setting] vary depending on the Speedlite model.

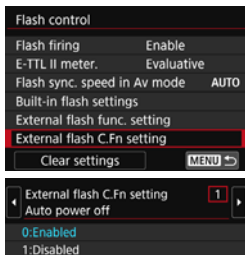

### 1 Display the Custom Function.

- With the camera ready to shoot with an external Speedlite, select [External flash C.Fn setting], then press <SET>.

### 2 Set the Custom Function.

- Press the <<> <>> keys to select the function number, then set the function. The procedure is the same as setting the camera's Custom Functions (p.336).

With an EX-series Speedlite, if the [Flash metering mode] Custom Function is set to [TTL flash metering] (autoflash), the Speedlite will always fire at full output.

## Clearing the Settings

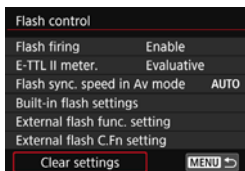

### 1 Select [Clear settings].

- Under the [📷 1: Flash control] tab, select [Clear settings], then press <SET>.

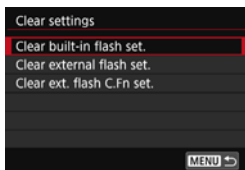

### 2 Select the settings to be cleared.

- Select [Clear built-in flash set.], [Clear external flash set.], or [Clear ext. flash C.Fn set.], then press <SET>.
- When you select [OK], the respective flash settings will be cleared.

The Speedlite's Personal Function (P.Fn) cannot be set or canceled with the camera's [Flash control] screen. Set it with the Speedlite.

## Using Wireless Flash ☆

The camera's built-in flash can work as a master unit for Canon EX-series, external Speedlites having a wireless slave feature. It can wirelessly trigger the Speedlite(s) to fire via optical transmission. Be sure to read the instructions and cautions about wireless flash photography (optical transmission) in the Speedlite's instruction manual.

### Slave Unit Settings and Position

Regarding your Speedlite (slave unit), refer to its instruction manual and set it as follows. The settings other than the ones below for the slave unit's control are all set with the camera. Different types of Speedlite slave units can be used and controlled together.

- (1) Set the external Speedlite as a slave unit.
- (2) Set the Speedlite's transmission channel to the same channel as set on the camera.<sup>\*1</sup>
- (3) For flash ratio control (p.187), set the slave unit's firing group.
- (4) Position the camera and slave unit(s) within the range shown below.
- (5) Face the slave unit's wireless sensor toward the camera.<sup>\*2</sup>

Example of Wireless Flash Set-up

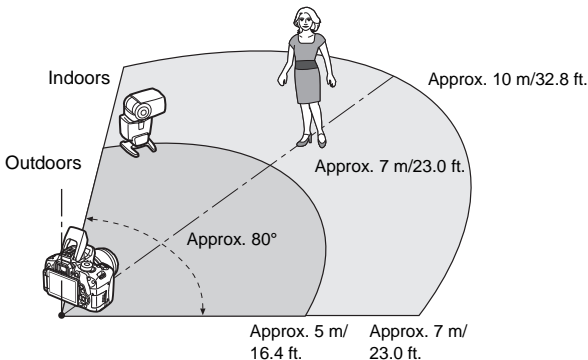

- \*1: If the Speedlite does not have a transmission channel setting function, it operates regardless of the channel set on the camera.
- \*2: In small rooms, the slave unit may work even if its wireless sensor does not face the camera. The camera's wireless signals can bounce off the walls and be received by the slave unit. When using an EX-series Speedlite with fixed light-emitting unit (flash head) and wireless sensor, take pictures while making sure it can fire.

### ● **Canceling the slave unit's auto power off**

To cancel the slave unit's auto power off, press the camera's <✳> button. If you are using manual flash firing, press the slave unit's test firing (PILOT) button to cancel the auto power off.

 The camera's master function cannot be used for wireless flash shooting with radio transmission.

## Wireless Flash Shooting Configurations

The tables below show the possible configurations for wireless flash shooting. Choose the configuration suiting the subject, shooting conditions, the number of external Speedlites you use, etc.

	External Speedlite		Built-in Flash	Page	Setting	
	Quantity	A:B Flash Ratio			Wireless Functions	Firing Group
Fully Automatic (E-TTL II autoflash)	Single	-	-	p.182		All
	Single	-	Used	p.185	+	-
	Multiple	-	-	p.184		All
	Multiple	Set	-	p.187		(A:B)
	Multiple	-	Used	p.188	+	All and
	Multiple	Set	Used		+	(A:B)
	• Flash exposure compensation				p.189	
• FE lock						

	External Speedlite		Built-in Flash	Page	Setting	
	Quantity	A:B Flash Ratio			Wireless Functions	Firing Group
Manual Flash	Single/ Multiple	-	-	p.190		All
	Multiple	Set	-			(A:B)
	Single/ Multiple	-	Used		+	All and
	Multiple	Set	Used		+	(A:B)

Even if you disable the built-in flash from firing, it will still fire in order to control the slave unit via optical transmission. The flash fired to control the slave unit may therefore appear in the picture depending on the shooting conditions.

# Easy Wireless Flash Shooting ☆

The basics of easy, fully automatic wireless flash shooting are explained below.

## Fully Automatic Shooting with One External Speedlite

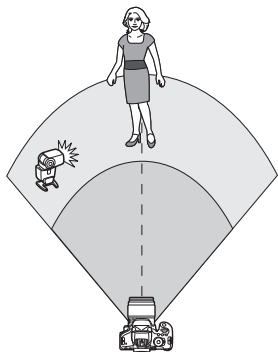

Steps 1 to 4 and 6 apply to all wireless flash shooting. Therefore, these steps are omitted in other wireless flash setups explained on the pages hereafter.

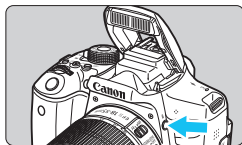

### 1 Press the <math>\lt;/math> button to raise the built-in flash.

- For wireless flash shooting, be sure to raise the built-in flash.

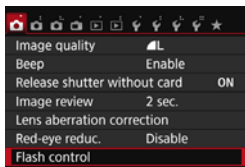

### 2 Select [Flash control].

- Under the [1] tab, select [Flash control], then press <math>\langle \text{SET} \rangle</math>.

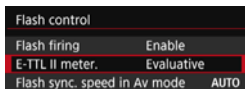

### 3 Select [Evaluative].

- For [E-TTL II meter.], select [Evaluative], then press <math>\langle \text{SET} \rangle</math>.

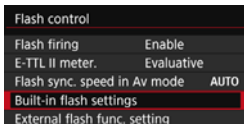

#### 4 Select [Built-in flash settings].

- Select [**Built-in flash settings**], then press < (SET) >.

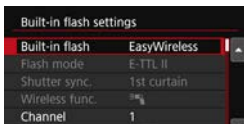

#### 5 Select [EasyWireless].

- For [**Built-in flash**], select [**EasyWireless**], then press < (SET) >.

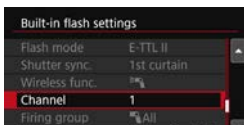

#### 6 Set [Channel].

- Set the transmission channel (1-4) to the same one as the slave unit.

#### 7 Take the picture.

- Set the camera and take the picture in the same way as with normal shooting.

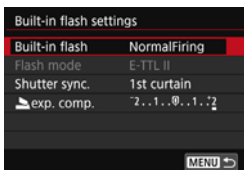

#### 8 Exit the wireless flash shooting.

- For [**Built-in flash**], select [**NormalFiring**].



- Setting [**E-TTL II meter.**] to [**Evaluative**] is recommended.
- Even though the firing of the built-in flash is disabled when [**EasyWireless**] is set, it will still fire a small flash in order to control the slave unit. Depending on shooting conditions, the flash fired to control the slave unit may appear in the picture.
- Firing a test flash is not possible with the slave unit.

## Fully Automatic Shooting with Multiple External Speedlites

You can have multiple slave units fire as if they were a single Speedlite. This is convenient when you need a large flash output.

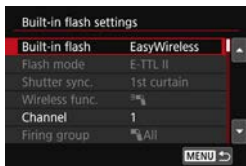

### Basic settings:

**Flash mode** : E-TTL II

**E-TTL II meter.** : Evaluative

**Built-in flash** : EasyWireless

**Channel** : (Same as slave units)

All the slave units will fire at the same output and be controlled to obtain a standard exposure.

No matter which firing group (A, B, or C) the slave units belong to, they will all fire as one group.

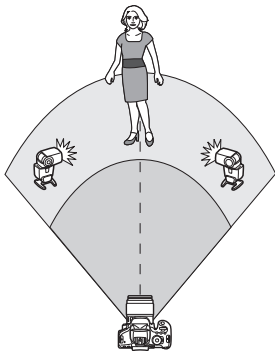

## Flash Exposure Compensation

If the flash exposure looks too dark or too bright, you can set flash exposure compensation to adjust the slave units' flash output.



- Select [**exp. comp.**], then press <SET>.
- If the flash exposure is too dark, press the <▶> key to increase the flash exposure and make it brighter. If the flash exposure is too bright, press the <◀> key to decrease the flash exposure and make it darker.



# Custom Wireless Flash Shooting ☆

## Fully Automatic Shooting with One External Speedlite and Built-in Flash

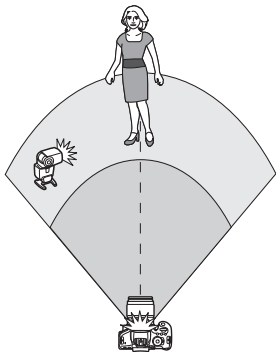

This is fully automatic wireless flash shooting with one external Speedlite and the built-in flash.

You can change the flash ratio between the external Speedlite and built-in flash to adjust how the shadows cast on the subject.

On the menu screens, the  $\langle \text{Speedlite icon} \rangle$  and  $\langle \text{Built-in flash icon} \rangle$  icons indicate the external Speedlite, and the  $\langle \text{Speedlite icon} \rangle$  and  $\langle \text{Built-in flash icon} \rangle$  icons indicate the built-in flash.

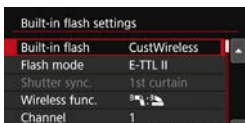

### 1 Select [CustWireless].

- Follow step 5 on page 183 to select [CustWireless], then press  $\langle \text{SET} \rangle$ .

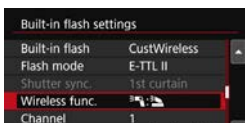

### 2 Select [Wireless func.].

- For [Wireless func.], select  $[\text{Speedlite icon} : \text{Built-in flash icon}]$ , then press  $\langle \text{SET} \rangle$ .

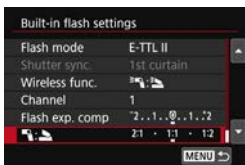

### 3 Set the desired flash ratio and take the picture.

- Select  $[\text{Speedlite icon} : \text{Built-in flash icon}]$  and set the flash ratio within 8:1 to 1:1. Setting a flash ratio to the right of 1:1 is not possible.
- If the built-in flash output is not enough, set a higher ISO speed (p.122).

The 8:1 to 1:1 flash ratio is equivalent to 3:1 to 1:1 stops (1/2-stop increments).

## Fully Automatic Shooting with Multiple External Speedlites

Multiple Speedlite slave units can be fired as one flash unit, or separated into slave groups for shooting with flash ratio control. The basic settings are shown below. By changing the **[Firing group]** setting, you can shoot with various wireless flash setups with multiple Speedlites.



### Basic settings:

**Flash mode** : E-TTL II

**E-TTL II meter.** : Evaluative

**Wireless func.** : [Icon]

**Channel** : (Same as slave units)

### [Icon All] Firing multiple slave Speedlites as one flash unit

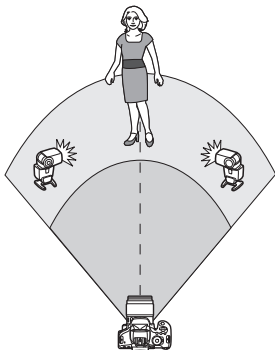

Convenient when you need a large flash output. All the slave units will fire at the same output and be controlled to obtain a standard exposure.

No matter which firing group (A, B, or C) the slave units belong to, they will all fire as one group.



Set **[Firing group]** to **[Icon All]**, then take the picture.

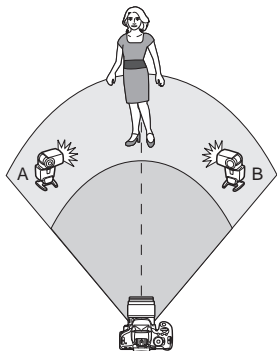

## [ (A:B)] Firing multiple slave units in multiple groups

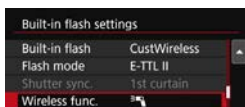

You can divide the slave units into groups A and B, and change the flash ratio to obtain the desired lighting effect. Refer to the Speedlite's instruction manual and set one slave unit to firing group A and the other to firing group B. Position the Speedlites as shown in the illustration.



### 1 Select [**Wireless func.**].

- Follow step 2 on page 185 to select [, then press <.>

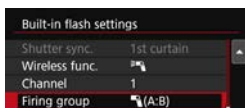

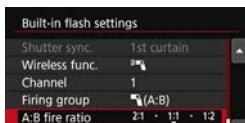

### 2 Set [**Firing group**] to [ (A:B)].



### 3 Set the A:B flash ratio and shoot.

- Select [**A:B fire ratio**] and set the flash ratio.

 If [**Firing group**] is set to [ (A:B)], group C will not fire.

 The 8:1 to 1:1 to 1:8 flash ratio is equivalent to 3:1 to 1:1 to 1:3 stops (1/2-stop increments).

## Fully Automatic Shooting with the Built-in Flash and Multiple External Speedlites

The built-in flash can also be added to wireless flash shooting explained on pages 186-187.

The basic settings are shown below. By changing the **[Firing group]** setting, you can shoot with various wireless flash setups of multiple Speedlites complemented with the built-in flash.



### 1 Basic settings:

- Flash mode** : E-TTL II
- E-TTL II meter.** : Evaluative
- Wireless func.** : [Flash + Slave]
- Channel** : (Same as slave units)



### 2 Select [Firing group].

- Select the firing group, then set the flash ratio, flash exposure compensation, and other necessary settings before shooting.

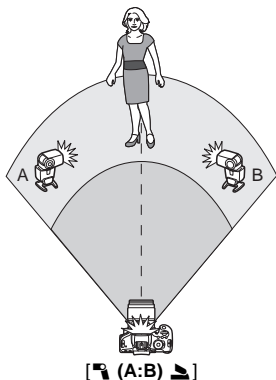
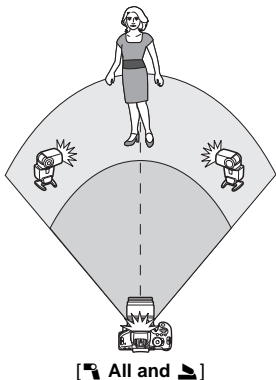

## Flash Exposure Compensation

When **[Flash mode]** is set to **[E-TTL II]**, flash exposure compensation can be set. The flash exposure compensation settings (see below) which can be set vary depending on the **[Wireless func.]** and **[Firing group]** settings.

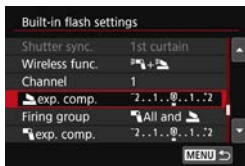

### **[Flash exp. comp.]**

- The set amount of flash exposure compensation will be applied to the built-in flash and all the external Speedlites.

### **[ exp. comp.]**

- Flash exposure compensation is applied only to the built-in flash.

### **[ exp. comp.]**

- The set amount of flash exposure compensation will be applied to all the external Speedlites.

## FE Lock

If **[Flash mode]** is set to **[E-TTL II]**, you can press the **< \* >** button to perform FE lock.

## Setting the Flash Output Manually for Wireless Flash Shooting

When **[Flash mode]** is set to **[Manual flash]**, flash exposure can be set manually. The flash output settings that can be set (**[Flash output]**, **[Group A output]**, etc.) vary depending on the **[Wireless func.]** setting (see below).

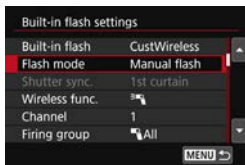

### **[Wireless func. All]**

- **[Firing group: All]:**  
The manual flash output setting is applied to all the external Speedlites.
- **[Firing group: (A:B)]:**  
You can set the flash output separately for slave groups A and B.

### **[Wireless func. All and Built-in]**

- **[Firing group: All and Built-in]:**  
The flash output can be set separately for the external Speedlite(s) and built-in flash.
- **[Firing group: (A:B) Built-in]:**  
You can set the flash output separately for slave groups A and B. You can also set the flash output for the built-in flash.

# 7

## Shooting with the LCD Monitor (Live View Shooting)

You can shoot while viewing the picture on the camera's LCD monitor. This is called “Live View shooting”.

- If you handhold the camera and shoot while viewing the LCD monitor, camera shake can cause blurred images. Using a tripod is recommended.





### Remote Live View Shooting

With EOS Utility (EOS software, p.404) installed on your computer, you can connect the camera to the computer and shoot remotely while viewing the computer screen. For details, refer to the EOS Utility Instruction Manual (p.406).

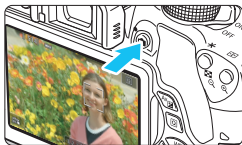
## Shooting with the LCD Monitor



### 1 Display the Live View image.

- Press the  button.
- ▶ The Live View image will appear on the LCD monitor. In the  mode, the scene icon for the scene detected by the camera is displayed on the upper left (p.196).
- By default, Continuous AF (p.204) will take effect.
- The Live View image will closely reflect the brightness level of the actual image you capture.



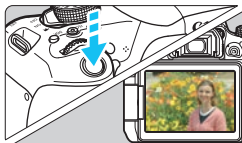

### 2 Focus on the subject.

- When you press the shutter button halfway, the camera will focus with the current AF method (p.206).



### 3 Take the picture.

- Press the shutter button completely.
- ▶ The picture will be taken and the captured image is displayed on the LCD monitor.
- ▶ When the playback display ends, the camera will return to Live View shooting automatically.
- Press the  button to exit the Live View shooting.

- The image's field of view is approx. 100% (with the image-recording quality set to JPEG ).
- During Live View shooting, pictures will be taken with One-Shot AF (p.101) for all the shooting modes.
- In Creative Zone modes, you can check the depth of field by pressing the depth-of-field preview button.
- During continuous shooting, the exposure set for the first shot will also be applied to the subsequent shots.
- You can also tap the subject on the LCD monitor to focus (p.206-213) and shoot (p.214).
- You can also use a remote controller (sold separately, p.350) for Live View shooting.



## Enabling Live View Shooting

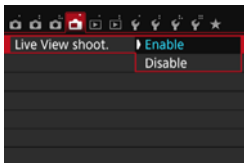

Set [: Live View shoot.] to [Enable].

### Number of Possible Shots with Live View Shooting (Approx. number of shots)

Temperature	Room Temperature (23°C / 73°F)	Low Temperatures (0°C / 32°F)
No Flash	200	170
50% Flash Use	180	150

- The figures above are based on a fully-charged Battery Pack LP-E17 and CIPA (Camera & Imaging Products Association) testing standards.
- With a fully-charged Battery Pack LP-E17, continuous Live View shooting is possible for approx. 1 hr. 30 min. at room temperature (23°C / 73°F).



- In the <img alt="video mode icon"/> mode, Live View shooting is not possible.
- In the <img alt="macro mode icon"/> and <img alt="macro mode icon with star"/> modes, the shooting range will be smaller.
- When the flash is recycling, "BUSY" is displayed on the LCD monitor, and you cannot view the subject.
- Do not point the camera toward an intense light source, such as the sun or an intense artificial light source. Doing so may damage the image sensor or the camera's internal components.
- **General Live View Shooting Cautions are on pages 218-219.**



- When flash is used, there will be two shutter sounds, but only one shot will be taken. Also, the time it takes to capture an image after you press the shutter button completely will be slightly longer than with viewfinder shooting.
- If the camera is not operated for a prolonged period, the power will turn off automatically after the time set in [2: Auto power off] (p.257). If [2: Auto power off] is set to [Disable], Live View shooting will end automatically after 30 min. (camera power remains on).
- With the HDMI cable HTC-100 (sold separately) or stereo AV cable AVC-DC400ST (sold separately), you can display the Live View image on a TV set (p.298, 301).

## Information Display

- Each time you press the <INFO.> button, the information display will change.

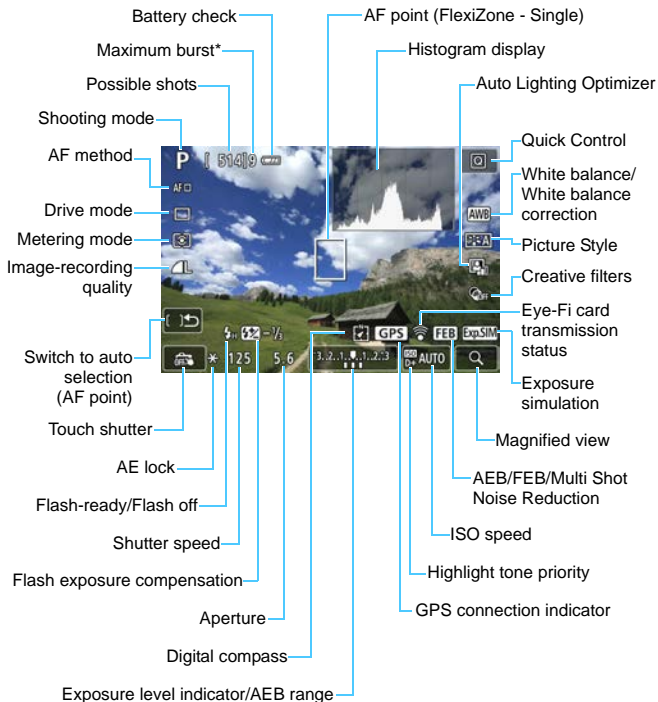

\* The number will be displayed when the maximum burst decreases to nine or lower.



- You can display the histogram by pressing the <INFO.> button. However, the histogram is not displayed while pressing the shutter button completely.
- When <Exp.SIM> is displayed in white, it indicates that the Live View image brightness is close to what the captured image will look like.
- If <Exp.SIM> is blinking, it indicates that the Live View image is displayed at a brightness that differs from the actual shooting result because of low- or bright-light conditions. However, the actual image recorded will reflect the exposure setting. Note that noise may be more noticeable than the actual image recorded.
- If the <P> or <A> shooting mode, Multi Shot Noise Reduction, flash, or bulb exposure is used, the <Exp.SIM> icon and histogram will be grayed out (for your reference). The histogram may not be properly displayed in low- or bright-light conditions.



**Do not hold the camera in the same position for long periods of time.**

Even if the camera does not feel too hot, prolonged contact with the same body part may cause skin redness, blistering or low-temperature contact burns. Using a tripod is recommended for people with circulation problems or very sensitive skin, or when using the camera in very hot places.

## Scene Icons

In the <A+> shooting mode, the camera will detect the scene type and set everything automatically to suit the scene. The detected scene type is indicated on the upper left of the screen. For certain scenes or shooting conditions, the icon displayed may not match the actual scene.

Subject Background	Portrait <sup>*1</sup>		Non-Portrait			Background Color
		Movement	Nature and Outdoor Scene	Movement	Close <sup>*2</sup>	
Bright						Gray
Backlit						
Blue Sky Included						Light blue
Backlit						
Sunset	*3			*3		Orange
Spotlight						Dark blue
Dark						
With Tripod	*4*5	*3	*4*5	*3		

\*1: Displayed only when the AF method is set to [ +Tracking]. If another AF method is set, the “Non-portrait” icon will be displayed even if a person is detected.

\*2: Displayed when the attached lens has distance information. With an Extension Tube or Close-up Lens, the icon displayed may not match the actual scene.

\*3: The icon suiting the scene detected will be displayed.

\*4: Displayed when all the following conditions apply:

The shooting scene is dark, it is a night scene, and the camera is mounted on a tripod.

\*5: Displayed with any of the lenses below:

- EF-S18-55mm f/3.5-5.6 IS II
- EF-S55-250mm f/4-5.6 IS II
- EF300mm f/2.8L IS II USM
- EF400mm f/2.8L IS II USM
- Image Stabilizer lenses marketed in 2012 or later.

\*4+\*5: If the conditions in both \*4 and \*5 are met, the shutter speed will slow down.

## Final Image Simulation

The final image simulation reflects the settings of the Picture Style, white balance and other functions in the Live View image so you can see what the captured image will look like.

During shooting, the Live View image will automatically reflect the function settings listed below.

### Final Image Simulation During Live View Shooting

- Picture Style
  - \* All settings such as sharpness, contrast, color saturation, and color tone will be reflected.
- White balance
- White balance correction
- Light/scene-based shots
- Background blur (in <CA> mode)
  - \* You can check the effect only during the setting procedure (when **[Simulating blur]** is displayed).
- Color tone
- Metering mode
- Exposure
- Depth of field (with depth-of-field preview button ON)
- Auto Lighting Optimizer
- Peripheral illumination correction
- Chromatic aberration correction
- Highlight tone priority
- Aspect ratio (shooting range confirmation)

# Shooting Function Settings

Function settings particular to Live View shooting are explained here.

## Q Quick Control

If you press the <Q> button when the image is displayed on the LCD monitor in a Creative Zone mode, you can set the following: **AF method**, **Drive mode**, Metering mode, **Image-recording quality**, White balance, Picture Style, Auto Lighting Optimizer, and **Creative filters**.

In Basic Zone modes, you can set the functions shown in the table on page 89 (except background blur), as well as the functions in bold above.





### 1 Press the <Q> button (10).

- ▶ The settable functions will be displayed.





### 2 Select a function and set it.

- Press the <▲> <▼> keys to select a function.
- ▶ The settings of the function and Feature guide (p.64) will appear.
- Press the <◀> <▶> keys to set the function.
- In the <SCN> mode, select the shooting mode box on the upper left of the screen, then press <SET> to select the shooting mode.
- To set the drive mode's <C> setting, WB correction/WB bracketing, Picture Style parameters, or Creative filter effects, press the <INFO.> button.

### 3 Exit the setting.

- Press <  > to finalize the setting and return to Live View shooting.
- You can also select [>] to return to Live View shooting.



- In Creative Zone modes, you can set the ISO speed by pressing the <ISO> button.
- With Live View shooting, you cannot set <  > or <  > for the drive mode.
- When you set  (Partial metering) or  (Spot metering), a circle indicating the metering area will be displayed on the center of the screen.

## Applying Creative Filters

While viewing the Live View image, you can apply a filter effect (Grainy B/W, Soft focus, Fish-eye effect, Art bold effect, Water painting effect, Toy camera effect, or Miniature effect) for shooting. These are called Creative filters.

When you take the picture, the camera saves only the image with the Creative filter applied. If you also want to save the image without a Creative filter applied, take the picture without a Creative filter. Then apply a Creative filter effect and save it as a new image (p.312).

**1 Set any shooting mode except <M>, <P>, or <A>.**

**2 Press the <Q> button (10).**

▶ The Quick Control screen will appear.

**3 Select [OFF].**

- Press the <▲> <▼> keys to select [OFF] (Creative filter) on the right side of the screen.



**4 Select a filter.**

- Press the <◀> <▶> keys to select a filter (p.202).
- ▶ The image will be displayed with the effects of the filter applied.







## 5 Adjust the filter effect.

- Press the <INFO.> button (except for Miniature effect).
- Press the <◀> <▶> keys to adjust the filter effect, then press <SET>.
- For the Miniature effect, press <SET>, then press the <▲> <▼> keys to move the white frame to where you want the image to look sharp.





## 6 Take the picture.



- ▶ The image is shot with the filter applied.

Even if you set the drive mode to <□> or <ⓈC>, the camera will still shoot in single shooting mode.

- You cannot shoot with Creative filters if the recording quality is **RAW** + **L** or **RAW**, or if AEB, white balance bracketing, or Multi Shot Noise Reduction is set.
- The histogram is not displayed when you shoot with Creative filters.
- With Grainy B/W, the grainy effect displayed on the LCD monitor will look different from the grainy effect recorded in the picture.
- With the Soft focus and Miniature effects, the blurred effect displayed on the LCD monitor will look different from the blurred effect recorded in the picture. In Creative Zone modes, you can check the picture's blurred effect by pressing the depth-of-field preview button.
- Dust Delete Data (p.272) will not be appended to images shot with Fish-eye effect applied.

## Creative Filter Characteristics

-  **Grainy B/W**  
Creates a grainy black-and-white photo. You can change the black-and-white effect by adjusting the contrast.
-  **Soft focus**  
Gives the image a soft look. You can change the degree of softness by adjusting the blur.
-  **Fish-eye effect**  
Gives the effect of a fish-eye lens. The image will have a barrel-type distortion.  
Depending on the level of this filter effect, the area trimmed along the periphery of the image changes. Also, since this filter expands the center part of the image, the resolution at the center may decrease depending on the number of recorded pixels. Check the image on the screen when setting this filter. The AF method will be FlexiZone - Single (fixed at center).
-  **Art bold effect**  
Makes the photo look like an oil painting and the subject look more three-dimensional. You can adjust the contrast and saturation. Note that the sky, white walls, and similar subjects may not be rendered with a smooth gradation and may look irregular or have significant noise.
-  **Water painting effect**  
Makes the photo look like a watercolor painting with soft colors. You can control the color density by adjusting the filter effect. Note that night scenes or dark scenes may not be rendered with a smooth gradation and may look irregular or have significant noise.

-  **Toy camera effect**  
Darkens the photo's corners and applies a color tone that makes it look as if it was shot by a toy camera. You can change the color cast by adjusting the color tone.
-  **Miniature effect**  
Creates a diorama effect. You can change where the image looks sharp. In step 5 on page 201, if you press the <math>\langle \text{Q} \rangle</math> button (or tap  on the lower right of the screen), you can switch between the white frame's vertical and horizontal orientations. The AF method will be FlexiZone - Single to focus at the center of the white frame.

## MENU Menu Function Settings

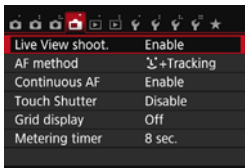

The menu options displayed are as follows.

**The settable functions on this menu screen apply only to Live View shooting. They do not work with viewfinder shooting (settings are disabled).**

### ● Live View shooting

You can set Live View shooting to **[Enable]** or **[Disable]**.

### ● AF method

You can select **[L+Tracking]**, **[FlexiZone - Multi]**, or **[FlexiZone - Single]**. See pages 206-213 for more about the AF method.

### ● Continuous AF

The default setting is **[Enable]**.

The camera focuses the subject continuously to achieve rough focus. This makes it quicker to achieve focus when you press the shutter button halfway. If **[Enable]** is set, the lens will operate constantly and consume more battery power. This will reduce the number of possible shots due to shorter battery life.

If you want to set the lens focus mode switch to **<MF>** during Continuous AF, first stop Live View shooting.

### ● Touch Shutter

Just by tapping on the LCD monitor screen, you can focus and take the picture automatically. For details, see page 214.

### ● Grid display

With **[Grid 1 ++]** or **[Grid 2 ###]**, you can display grid lines. You can check horizontal or vertical tilt when shooting.

- **Metering timer** <sup>☆</sup>

You can change how long the exposure setting is displayed (AE lock time). In Basic Zone modes, metering timer is fixed at 8 sec.



Selecting any of the following operations will stop Live View shooting. To start Live View shooting again, press the < > button.

- [ 3: Dust Delete Data], [ 3: Sensor cleaning], [ 4: Clear settings],  
or [ 4: firmware ver.]

# Using AF to Focus (AF Method)

## Selecting the AF Method

You can select an AF method to suit the shooting conditions and your subject. The following AF methods are provided: [**☺ (face)+Tracking**], [**FlexiZone - Multi**] (p.208), and [**FlexiZone - Single**] (p.210).

If you want to achieve precise focus, set the lens focus mode switch to <MF>, magnify the image, and focus manually (p.216).

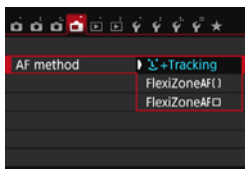

### Select the AF method.

- Under the [**📷**] tab, select [**AF method**].
- Select the desired AF method, then press <SET>.
- While the Live View image is displayed, you can also press the <Q> button to select the AF method on the Quick Control screen (p.198).

## ☺ (face)+Tracking: AF ☺

The camera detects and focuses on human faces. If a face moves, the AF point <☺> also moves to track the face.



### 1 Display the Live View image.

- Press the <📷> button.
- ▶ The Live View image will appear on the LCD monitor.

### 2 Select an AF point.

- When a face is detected, the AF point <☺> will appear over the face to be focused on.
- If multiple faces are detected, <☺☺> will be displayed. Use the <◀> <▶> keys to move the <☺> frame over the face you want to focus on.

- You can also tap on the LCD monitor screen to select the face or subject. If the subject is not a face,  $\langle \text{AF} \text{ } \rangle$  will be displayed.
- If no faces can be detected, or if you tap on the LCD monitor but do not select any face or subject, the camera will switch to **[FlexiZone - Multi]** with automatic selection (p.208).

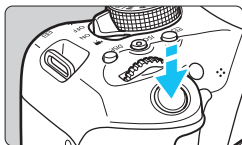

### 3 Focus on the subject.

- Press the shutter button halfway to focus.
- ▶ When focus is achieved, the AF point will turn green and the beeper will sound.
- ▶ If focus is not achieved, the AF point will turn orange.



### 4 Take the picture.

- Check the focus and exposure, then press the shutter button completely to take the picture (p.192).



- If the subject's face is significantly out of focus, face detection will not be possible. In such a case, set the lens's focus mode switch to  $\langle \text{MF} \rangle$  and focus manually.
- An object other than a human face may be detected as a face.
- Face detection will not work if the face is very small or large in the picture, too bright or too dark, or partially hidden.
- The  $\langle \text{AF} \text{ } \rangle$  may cover only a part of the face.

- If you press  $\langle \text{SET} \rangle$  or the  $\langle \text{AF} \rangle$  button, the AF point  $\langle \text{AF} \rangle$  will appear at the center and you can use the  $\langle \text{Cross} \rangle$  cross keys to move the AF point.
- Since AF is not possible with a face detected near the edge of the picture, the  $\langle \text{AF} \rangle$  will be grayed out. If you press the shutter button halfway, the subject will be focused on, in FlexiZone - Multi method with automatic selection.

## FlexiZone - Multi: AF ( )

You can use up to 49 AF points for wide-area focusing (automatic selection). This wide area can also be divided into 9 zones for focusing (zone selection).



Area frame

### 1 Display the Live View image.

- Press the  $\langle \text{Live View} \rangle$  button.
- ▶ The Live View image will appear on the LCD monitor.



### 2 Select the AF point. ☆

- Pressing  $\langle \text{SET} \rangle$  or the  $\langle \text{AF} \rangle$  button will toggle between automatic selection and zone selection. In Basic Zone modes, automatic selection is set automatically.
- Use the  $\langle \text{Cross} \rangle$  cross keys to select a zone. To return to the center zone, press  $\langle \text{SET} \rangle$  or the  $\langle \text{AF} \rangle$  button again.
- You can also tap on the LCD monitor screen to select a zone. When a zone is selected, tap  $\langle \text{AF} \rangle$  on the screen to switch to automatic selection.



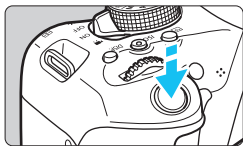

### 3 Focus on the subject.

- Aim the AF point over the subject and press the shutter button halfway.
- ▶ When focus is achieved, the AF point will turn green and the beeper will sound.
- ▶ If focus is not achieved, the area frame will turn orange.



### 4 Take the picture.

- Check the focus and exposure, then press the shutter button completely to take the picture (p.192).



- If the camera does not focus on the desired target subject with automatic AF point selection, select a zone or switch the AF method to [**FlexiZone - Single**] and refocus.
- The number of AF points varies, depending on the [**3: Aspect ratio**] setting. At [**3:2**], [**4:3**], and [**16:9**], there are 49 AF points. At [**1:1**], 35 AF points.

## FlexiZone - Single: AF □

The camera focuses with a single AF point. This is effective when you want to focus on a particular subject.



AF point

### 1 Display the Live View image.

- Press the <📷> button.
- ▶ The Live View image will appear on the LCD monitor.
- ▶ The AF point <□> will appear.
- During movie shooting, if **[Movie Servo AF]** is set to **[Enable]**, the AF point will be displayed in a larger size.



### 2 Move the AF point.

- Press the <⬆️⬇️⬆️⬇️> cross keys to move the AF point to where you want to focus. (It cannot go to the edge of the screen.)
- Pressing <ⓈⓔṪ> or the <🗑️> button will return the AF point to the screen's center.
- You can also tap on the LCD monitor screen to move the AF point.

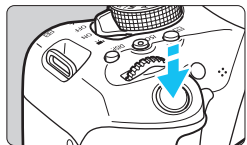

### 3 Focus on the subject.

- Aim the AF point over the subject and press the shutter button halfway.
- ▶ When focus is achieved, the AF point will turn green and the beeper will sound.
- ▶ If focus is not achieved, the AF point will turn orange.



### 4 Take the picture.

- Check the focus and exposure, then press the shutter button completely to take the picture (p.192).

## Notes for AF

### AF Operation

- Even when focus is achieved, pressing the shutter button halfway will focus again.
- You cannot focus on a moving subject continuously.
- The image brightness may change during and after the AF operation.
- Depending on the subject or shooting conditions, etc., focusing may take longer or the continuous shooting speed may become slower.
- If the light source changes while the Live View image is displayed, the screen may flicker and focusing may be difficult. If this happens, exit Live View shooting and execute AF under the actual light source.
- If [**Ⓛ** +Tracking] is set, magnified view is not possible.
- When [**FlexiZone - Multi**] is set and you press the <Q> button (or tap <Q> on the screen), the center of the selected zone (or image center with automatic selection) will be magnified. If you press the shutter button halfway, the display will return to normal and the camera will focus.
- When [**FlexiZone - Single**] is set and you press the <Q> button (or tap <Q> on the screen), the area covered by the AF point will be magnified. Press the shutter button halfway to focus in the magnified view. This is effective when the camera is attached to a tripod and you need to attain very precise focus. If focusing is difficult in magnified view, return to the normal display and use AF. Note that the AF speed may differ between the normal and magnified views.
- If you magnify the view after focusing with [**FlexiZone - Multi**] or [**FlexiZone - Single**] in the normal view, precise focus may not be achieved.



When in magnified view, Continuous AF (p.204) will not be executed.

## Shooting Conditions that Make Focusing Difficult

- Low-contrast subjects such as the blue sky, solid-color flat surfaces or when highlight or shadow details are lost.
- Subjects in low light.
- Stripes and other patterns where there is contrast only in the horizontal direction.
- Subjects with repetitive patterns (Example: Skyscraper windows, computer keyboards, etc.).
- Fine lines and subject outlines.
- Under a light source whose brightness, color, or pattern keeps changing.
- Night scenes or points of light.
- The image flickers under fluorescent or LED lighting.
- Extremely small subjects.
- Subjects at the edge of the picture.
- Strongly backlit or reflective subjects (Example: Car with a highly reflective body, etc.).
- The AF point covers both near and distant subjects (Example: Animal in a cage, etc.).
- Subjects that keep moving within the AF point and cannot keep still due to camera shake or subject blur.
- A subject approaching or moving away from the camera.
- Autofocusing while the subject is very far out of focus.
- Soft focus effect is applied with a soft focus lens.
- A special effect filter is used.
- Noise (spots, banding, etc.) appears on the screen during AF.



- If focus is not achieved with the shooting conditions on the preceding page, set the lens focus mode switch to **<MF>** and focus manually.
- If you use AF with any of the following lenses, focusing may take longer or correct focus may not be achieved.  
EF50mm f/1.4 USM, EF50mm f/1.8 II, EF50mm f/2.5 Compact Macro,  
EF75-300mm f/4-5.6 III, EF75-300mm f/4-5.6 III USM  
For information on discontinued lenses, refer to the Canon Web site.



- If you shoot a peripheral subject and it is out of focus, aim the center AF point or zone over the subject to focus, focus again and then take the picture.
- The AF-assist beam will not be emitted. However, if an EX-series Speedlite (sold separately) equipped with an LED light is used, the LED light will turn on for AF-assist when necessary.
- In magnified view, focusing may be difficult due to camera shake. Using a tripod is recommended.

## Shooting with the Touch Shutter

Just by tapping on the LCD monitor screen, you can focus and take the picture automatically. This works in all shooting modes.

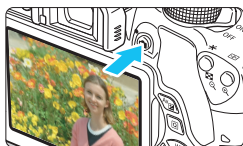





### 1 Display the Live View image.

- Press the <  > button.
- ▶ The Live View image will appear on the LCD monitor.



### 2 Enable the touch shutter.

- Tap [  ] on the screen's bottom left. Each time you tap on the icon, it will toggle between [  ] and [  ].
- [  ] (Touch shutter: Enable)  
You can tap on the spot to focus and shoot.
- [  ] (Touch shutter: Disable)  
You can tap on the spot to select where you want to focus. Press the shutter button completely to take the picture.

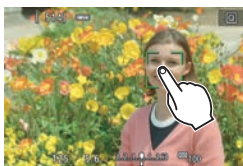

### 3 Tap on the screen to shoot.

- Tap on the face or subject on the screen.
- ▶ On the point you tap, the camera will focus in the AF method that was set (p.206-210). When [ **FlexiZone - Multi** ] is set, it will switch to [ **FlexiZone - Single** ].
- ▶ When focus is achieved, the AF point turns green and the picture is taken automatically.
- If focus is not achieved, the AF point turns orange and the picture cannot be taken. Tap on the face or subject on the screen again.



- Even if you set the drive mode to <img alt="Single frame icon" data-bbox="535 102 565 125"/>, the camera will still shoot in single shooting mode.
- The touch shutter does not work with the magnified view.
- If the Fish-eye effect Creative filter is set, the camera will focus using the AF point on the center of the screen regardless of the point you tap on.
- If the Miniature effect Creative filter is set, the touch shutter does not work.
- When [10: Shutter/AE lock button] is set to [1: AE lock/AF] or [3: AE/AF, no AE lock] under [4: Custom Functions (C.Fn)], autofocusing does not take effect.



- You can also set the touch shutter with [img alt="Touch shutter icon" data-bbox="585 347 615 364"/>: Touch shutter].
- To shoot with bulb exposure, tap on the screen twice. The first tap on the screen will start the bulb exposure. Tapping it again will stop the exposure. Be careful not to shake the camera when tapping on the screen.

# MF: Focusing Manually

You can magnify the image and focus precisely with manual focus.

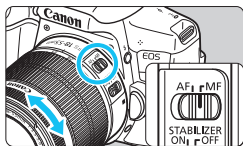

## 1 Set the lens focus mode switch to <MF>.

- Turn the lens focusing ring to focus roughly.

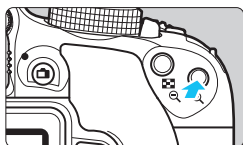

## 2 Display the magnifying frame.

- Press the <Q> button.
- ▶ The magnifying frame will appear.
- You can also tap [Q] on the screen to magnify the image.



## 3 Move the magnifying frame.

- Press the <⬆> cross keys to move the magnifying frame to the position where you want to focus.
- To return to the screen's center, press <SET> or the <⏏> button.

Magnifying frame

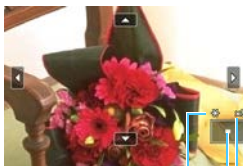

## 4 Magnify the image.

- Each time you press the <Q> button, the magnification of the image will change in the following sequence:

→ 1x → 5x → 10x → Normal view

AE lock

Magnified area position

Magnification



## 5 Focus manually.

- While looking at the magnified image, turn the lens focusing ring to focus.
- After achieving focus, press the <Ⓚ> button to return to the normal view.

## 6 Take the picture.







- Check the focus and exposure, then press the shutter button to take the picture (p.192).

## General Live View Shooting Cautions

### Image Quality

- When you shoot at high ISO speeds, noise (such as dots of light and banding) may become noticeable.
- Shooting in high temperatures may cause noise and irregular colors in the image.
- If Live View shooting is used continuously for a prolonged period, the camera's internal temperature may rise, and image quality may deteriorate. Always exit Live View shooting when you are not shooting.
- If you shoot a long exposure while the camera's internal temperature is high, image quality may deteriorate. Exit Live View shooting and wait a few minutes before shooting again.

### White and Red Internal Temperature Warning Icons

- If the camera's internal temperature increases due to prolonged Live View shooting or under a high ambient temperature, a white  or red  icon will appear.
- The white  icon indicates that the image quality of still photos will deteriorate. It is recommended that you temporarily exit Live View shooting and allow the camera to cool down before shooting again.
- The red  icon indicates that the Live View shooting will soon stop automatically. If this happens, you will not be able to shoot again until the camera's internal temperature decreases. Exit the Live View shooting or turn off the power and let the camera rest for a while.
- Using Live View shooting at a high temperature for a prolonged period will cause the  or  icon to appear earlier. When you are not shooting, always turn off the camera.
- If the camera's internal temperature is high, the quality of images shot with high ISO speed or long exposure may deteriorate even before the white  icon is displayed.

### Shooting Results

- If you take the picture in magnified view, the exposure may not come out as desired. Return to the normal view before taking the picture. In magnified view, the shutter speed and aperture will be displayed in orange. Even if you take the picture in magnified view, the image will be captured in the normal view range.
- If [ **2: Auto Lighting Optimizer**] (p.136) is set to any setting other than [**Disable**], the image may look bright even if a decreased exposure compensation or decreased flash exposure compensation is set.
- If you use a TS-E lens (except the TS-E17mm f/4L or TS-E24mm f/3.5L II) and shift or tilt the lens or use an Extension Tube, the standard exposure may not be obtained or an irregular exposure may result.



## General Live View Shooting Cautions

### Live View Image

- Under low- or bright-light conditions, the Live View image may not reflect the brightness of the captured image.
- Even if a low ISO speed is set, noise may be noticeable in the displayed Live View image under low light. However, when you shoot, the image recorded will have minimal noise. (The image quality of the Live View image is different from that of the recorded image.)
- If the light source (illumination) within the image changes, the screen may flicker. If this happens, exit Live View shooting and resume shooting under the actual light source.
- If you point the camera in a different direction, it may throw off the Live View image's correct brightness momentarily. Wait until the brightness level stabilizes before shooting.
- If there is a very bright light source in the image, the bright area may appear black on the LCD monitor. However, the actual captured image will correctly show the bright area.
- In low light, if you set the [**F2: LCD brightness**] to a bright setting, noise or irregular colors may appear in the Live View image. However, the noise or irregular colors will not be recorded in the captured image.
- When you magnify the image, the image sharpness may look more pronounced than in the actual image.
- If the shutter speed is 1 sec. or slower, "**BUSY**" is displayed on the LCD monitor, and the Live View display will not appear until the exposure is completed.

### Custom Functions

- During Live View shooting, some Custom Function settings will not take effect (p.337).

### Lens and Flash

- The focus preset function is possible for Live View shooting only when using a (super) telephoto lens equipped with the focus preset mode, available since the second half of 2011.
- FE lock will not work if the built-in flash is used. FE lock and modeling flash will not work if an external Speedlite is used.



# 8

## Shooting Movies

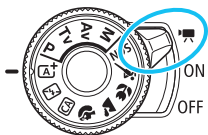

Movie shooting is enabled by setting the power switch to <img alt="camera icon with film strip" data-bbox="455 495 485 515"/>. The movie recording format will be MP4.

- For cards that can record movies, see page 5.
- If you handhold the camera and shoot movies, camera shake can cause blurred movies. Using a tripod is recommended.
- To shoot while handholding the camera, see page 70.



### Full HD 1080

Full HD 1080 indicates compatibility with High-Definition featuring 1080 vertical pixels (scanning lines).



# Shooting Movies

Connecting the camera to a TV set is recommended to play back the movies shot (p.298-301).

## Autoexposure Shooting

When the shooting mode is set to any mode other than <M>, autoexposure control will take effect to suit the scene's current brightness.

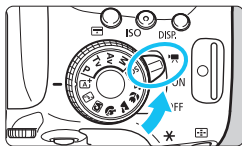

### 1 Set the power switch to <Movie>.

- ▶ The reflex mirror will make a sound, then the image will appear on the LCD monitor.

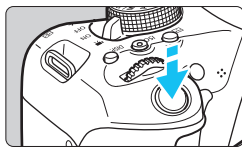

### 2 Set any shooting mode except <M>.

### 3 Focus on the subject.

- Before shooting a movie, focus with AF or manual focus (p.206-213, 216).
- By default, [Movie Servo AF: Enable] is set so that the camera will always focus. To stop Movie Servo AF, see page 248.



### 4 Shoot the movie.

- Press the <Movie> button to start shooting a movie. To stop movie shooting, press <Movie> again.
- ▶ While the movie is being shot, the "●" mark will be displayed on the upper right of the screen.
- ▶ Sound will be recorded by the built-in microphones.

Recording movie

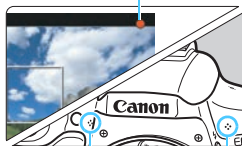

Built-in microphones



- **General Movie Shooting Cautions are on pages 253-254.**
- **If necessary, also read the General Live View Shooting Cautions on pages 218-219.**



- In Basic Zone modes, the shooting result will be the same as with  $\langle \text{A}^+ \rangle$ . Also, the scene icon for the scene detected by the camera is displayed on the upper left (p.224).
- In the  $\langle \text{Av} \rangle$  and  $\langle \text{Tv} \rangle$  shooting modes, movies will be taken with the same settings as in the  $\langle \text{P} \rangle$  mode.
- Settable menu functions differ between Basic Zone modes and Creative Zone modes (p.358).
- Shutter speed and aperture are set automatically.
- In Creative Zone modes, you can press the  $\langle * \rangle$  button (p.162) to lock the exposure (AE lock). The exposure setting will be displayed for the number of seconds set with [C.Fn 1: Metering timer]. After applying AE lock during movie shooting, you can cancel it by pressing the  $\langle \text{AE-L} \rangle$  button. (AE lock setting is retained until you press the  $\langle \text{AE-L} \rangle$  button.)
- In Creative Zone modes, you can hold down the  $\langle \text{Av} \text{ [Exposure Compensation] } \rangle$  button and turn the  $\langle \text{Exposure Compensation Dial} \rangle$  to set the exposure compensation.
- Pressing the shutter button halfway displays the shutter speed and ISO speed on the screen's bottom. This is the exposure setting for taking a still photo (p.227). The exposure setting for movie shooting is not displayed. Note that the exposure setting for movie shooting may differ from that for still photo shooting.
- If you shoot a movie with autoexposure, the shutter speed and aperture will not be recorded in the image information (Exif).

## ISO Speed in Basic Zone Modes



















- The ISO speed will be set automatically within ISO 100 - ISO 6400.

## ISO Speed in $\langle \text{P} \rangle$ , $\langle \text{Tv} \rangle$ , and $\langle \text{Av} \rangle$ Modes

- The ISO speed will be set automatically within ISO 100 - ISO 6400.
- Under [C.Fn 4: Custom Functions (C.Fn)], if [2: ISO expansion] is set to [1: On], the maximum speed will be expanded to H (equivalent to ISO 12800).
- Under [C.Fn 4: Custom Functions (C.Fn)], if [3: Highlight tone priority] is set to [1: Enable], the ISO speed will be ISO 200 - ISO 6400.

## Scene Icons

During movie shooting in a Basic Zone mode, an icon representing the scene detected by the camera will be displayed and the shooting will be adapted to that scene. For certain scenes or shooting conditions, the icon displayed may not match the actual scene.

Background \ Subject	Portrait* <sup>1</sup>	Non-Portrait		Background Color
		Nature and Outdoor Scene	Close* <sup>2</sup>	
Bright				Gray
Backlit				
Blue Sky Included				Light blue
Backlit				
Sunset	* <sup>3</sup>		* <sup>3</sup>	Orange
Spotlight				Dark blue
Dark				

\*1: Displayed only when the AF method is set to [ +Tracking]. If another AF method is set, the "Non-portrait" icon will be displayed even if a person is detected.

\*2: Displayed when the attached lens has distance information. With an Extension Tube or Close-up Lens, the icon displayed may not match the actual scene.

\*3: The icon suiting the scene detected will be displayed.

## Using an EX-series Speedlite (Sold Separately) Equipped with an LED Light

With autoexposure (modes other than **M**) movie shooting, the camera will automatically turn on the Speedlite's LED light under low-light conditions. **For details, refer to the Speedlite's instruction manual.**



## Manual Exposure Shooting

In the <M> mode, you can freely set the shutter speed, aperture, and ISO speed for movie shooting. Using manual exposure to shoot movies is for advanced users.

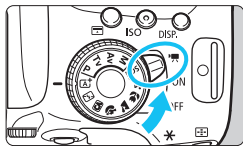

### 1 Set the power switch to <M>.

- ▶ The reflex mirror will make a sound, then the image will appear on the LCD monitor.



### 2 Set the Mode Dial to <M>.

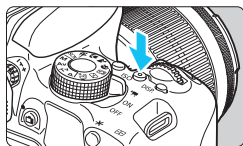

### 3 Set the ISO speed.

- Press the <ISO> button and press the <◀> <▶> keys or turn the <ISO> dial to select the ISO speed.
- For details on the ISO speed, see the next page.



### 4 Set the shutter speed and aperture.

- To set the shutter speed, turn the <Shutter> dial. The settable shutter speeds vary depending on the frame rate <Frame Rate>.
  - 29.97P 25.00P 23.98P : 1/4000 sec. - 1/30 sec.
  - 59.94P 50.00P : 1/4000 sec. - 1/60 sec.
- To set the aperture, hold down the <Av> button and turn the <Aperture> dial.



## 5 Focus and shoot the movie.

- The procedure is the same as steps 3 and 4 for “Autoexposure Shooting” (p.222).

### ISO Speed During Manual Exposure Shooting

- With [AUTO], the ISO speed will be set automatically within ISO 100 - ISO 6400.
- You can set the ISO speed manually within ISO 100 - ISO 6400 in whole-stop increments. Under [**F4: Custom Functions (C.Fn)**], if [**2: ISO expansion**] is set to [**1: On**], the manual setting range will expand so you can also select H (equivalent to ISO 12800).
- Under [**F4: Custom Functions (C.Fn)**], if [**3: Highlight tone priority**] is set to [**1: Enable**], the ISO speed will be ISO 200 - ISO 6400.

- Since shooting a movie at ISO 12800 may result in much noise, it is designated as an expanded ISO speed (displayed as “H”).
- If ISO speed is set to H (ISO 25600) when [**2: ISO expansion**] is set to [**1: On**] under [**F4: Custom Functions (C.Fn)**] and you switch from still photo shooting to movie shooting, the ISO speed will be H (equivalent to ISO 12800). When you switch back to still photo shooting, the ISO speed will be ISO 12800.
- Exposure compensation cannot be set.
- Changing the shutter speed or aperture during movie shooting is not recommended since the changes in the exposure will be recorded.
- If you change the shutter speed while shooting under fluorescent or LED lighting, image flicker may be recorded.

- When ISO Auto is set, you can press the <★> button to lock the ISO speed.
- If you press the <★> button and recompose the shot, you can see the exposure level difference on the exposure level indicator (p.227) compared to when the <★> button was pressed.
- By pressing the <INFO.> button, you can display the histogram.
- When shooting a movie of a moving subject, a shutter speed of 1/30 sec. to 1/125 sec. is recommended. The faster the shutter speed, the less smooth the subject’s movement will look.

## Information Display

- Each time you press the <INFO.> button, the information display will change.

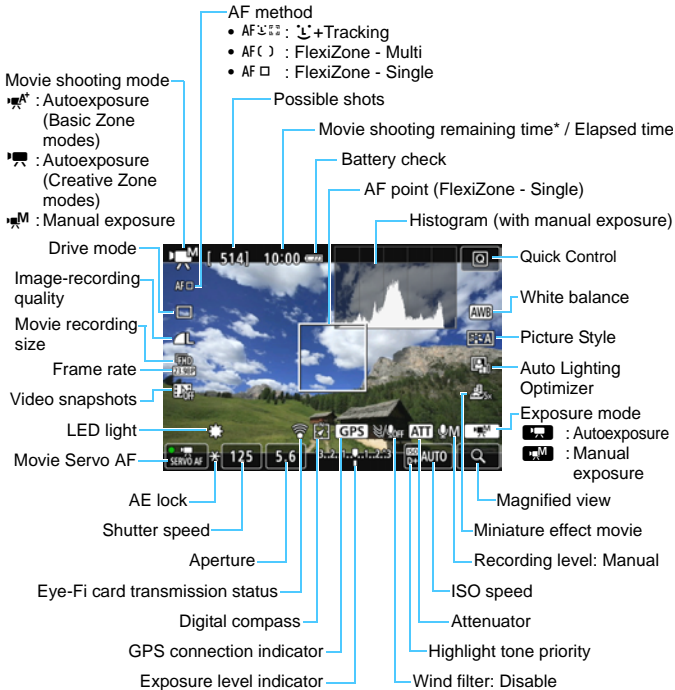

\* Applies to a single movie clip.



- The grid lines or histogram cannot be displayed during movie shooting. (The display will disappear when you start shooting a movie.)
- When movie shooting starts, the movie shooting remaining time will change to the elapsed time.

## Cautions for Movie Shooting

- Do not point the camera toward an intense light source, such as the sun or an intense artificial light source. Doing so may damage the image sensor or the camera's internal components.
- If <AWB> is set and the ISO speed or aperture changes during movie shooting, the white balance may also change.
- If you shoot a movie under fluorescent or LED lighting, the movie may flicker.
- Zooming the lens during movie shooting is not recommended. Zooming the lens can cause changes in the exposure regardless of whether the lens's maximum aperture changes or not. Exposure changes may be recorded as a result.
- You cannot magnify the image during movie shooting.
- Be careful not to cover the built-in microphones (p.222) with your finger, etc.
- **General Movie Shooting Cautions are on pages 253-254.**
- **If necessary, also read the General Live View Shooting Cautions on pages 218-219.**

## Do not hold the camera in the same position for long periods of time.

Even if the camera does not feel too hot, prolonged contact with the same body part may cause skin redness, blistering or low-temperature contact burns. Using a tripod is recommended for people with circulation problems or very sensitive skin, or when using the camera in very hot places.



- Movie-related settings are under the [CAM 1] and [CAM 2] tabs (p.248).
- A movie file is recorded each time you shoot a movie. If the file size exceeds 4 GB, a new file will be created for every subsequent 4 GB.
- The movie image's field of view is approx. 100% (with movie recording size set to [1920]).
- Stereo sound is recorded by the camera's built-in microphones (p.222).
- Most external microphones (commercially available) equipped with a 3.5 mm diameter mini plug can be used.
- You can use Remote Controller RC-6 (sold separately, p.350) to start and stop the movie shooting if the drive mode is <[M] >. Set the shooting timing switch to <2> (2-sec. delay), then press the transmit button. If the switch is set to <●> (immediate shooting), still photo shooting will take effect.
- With a fully-charged Battery Pack LP-E17, the total movie shooting time will be as follows: approx. 1 hr. 20 min. at room temperature (23°C/73°F), and approx. 1 hr. at low temperatures (0°C/32°F).
- The focus preset function is possible for movie shooting when using a (super) telephoto lens equipped with the focus preset mode, available since the second half of 2011.

## Final Image Simulation

The final image simulation shows the results of the current settings for the Picture Style, white balance, etc., on the image.

During movie shooting, the image displayed will automatically show the effects of the settings listed below.

### Final Image Simulation for Movie Shooting

- Picture Style
  - \* All settings such as sharpness, contrast, color saturation, and color tone will be reflected.
- White balance
- White balance correction
- Exposure
- Depth of field
- Auto Lighting Optimizer
- Peripheral illumination correction
- Chromatic aberration correction
- Highlight tone priority
- Miniature effect movie

## Shooting Still Photos

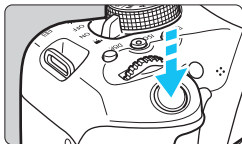

While shooting a movie, you can also take a still photo by pressing the shutter button completely.

### Taking Still Photos during Movie Shooting

- If you take a still photo during movie shooting, the movie will record a still moment lasting approx. 1 sec.
- The captured still photo will be recorded to the card, and the movie shooting will resume automatically when the Live View image is displayed.
- The movie and still photo will be recorded as separate files on the card.
- Functions particular to still photo shooting are shown below. Other functions will be the same as for movie shooting.

Function	Settings
<b>Image-Recording Quality</b>	As set in [📷1: Image quality]. When the movie recording size is [1920x1080] or [1280x720], the aspect ratio will be 16:9. When the size is [640x480], the aspect ratio will be 4:3.
<b>ISO Speed*</b>	<ul style="list-style-type: none"> <li>• With autoexposure shooting: Automatically set within ISO 100 - ISO 6400.</li> <li>• With manual exposure shooting: See "ISO Speed During Manual-exposure Shooting" on page 226.</li> </ul>
<b>Exposure Setting</b>	<ul style="list-style-type: none"> <li>• With autoexposure shooting: Automatically-set shutter speed and aperture (displayed when pressing the shutter button halfway).</li> <li>• With manual exposure shooting: Manually-set shutter speed and aperture.</li> </ul>
<b>AEB</b>	Canceled
<b>Flash</b>	Flash off

\* If highlight tone priority is set, the ISO speed range will start from ISO 200.

- Regardless of the drive mode setting, single shooting will take effect for still photo shooting during movie shooting.
- The self-timer can be set before you start shooting a movie. During movie shooting, the camera will switch to single shooting.



When you press the shutter button halfway to autofocus during movie shooting, the following phenomena may occur.

- Focus may become far off momentarily.
- The brightness of the recorded movie may change.
- The recorded movie may be momentarily still.
- The movie may record the lens operation noise.
- You cannot shoot still photos when focus is not achieved, such as when the subject is moving.

# Shooting Function Settings

Function settings particular to movie shooting are explained here.

## Q Quick Control

If you press the <Q> button while the image is displayed on the LCD monitor, you can set any of the following: **AF method**, **Drive mode**, **Image-recording quality (still photos)**, **Movie recording size**, **Video snapshots**, White balance, Picture Style, Auto Lighting Optimizer, and **Miniature effect movie**.

In Basic Zone modes, only the functions in bold can be set.



### 1 Press the <Q> button (10).

- ▶ The settable functions will be displayed.

### 2 Select a function and set it.

- Press the <▲> <▼> keys to select a function.
- ▶ The selected function and Feature guide (p.64) will appear.
- Press the <◀> <▶> keys to set the function.
- To set the drive mode's <C>, WB correction/WB bracketing, or Picture Style parameters, press the <INFO.> button.

### 3 Exit the setting.

- Press <SET> to finalize the setting and return to movie shooting.
- You can also select <↶> to return to movie shooting.



## MENU Setting the Movie Recording Size



With [**2: Movie rec. size**], you can set the movie recording size (image size, frame rate, and compression method) and other functions.

### ● Image Size

#### **FHD 1920x1080**

Full High-Definition (Full HD) recording quality. The aspect ratio is 16:9.

#### **HD 1280x720**

High-Definition (HD) recording quality. The aspect ratio is 16:9.

#### **VGA 640x480**

Standard-definition recording quality. The aspect ratio is 4:3.

### ● Frame Rate (fps: frames per second)

#### **29.97P 29.97 fps / 59.94P 59.94 fps**

For areas where the TV format is NTSC (North America, Japan, South Korea, Mexico, etc.).

#### **25.00P 25.00 fps / 50.00P 50.00 fps**

For areas where the TV format is PAL (Europe, Russia, China, Australia, etc.).

#### **23.98P 23.98 fps**

Mainly for motion pictures.



The frame rate displayed on the movie recording size screen switches depending on whether [**3: Video system**] is set to [**NTSC**] or [**PAL**].

**23.98P** (23.98 fps) can be selected only when [**NTSC**] is set.

- **Compression Method**

**Standard**

Compresses multiple frames at a time efficiently for recording.











**Light (📶)**

The movie is recorded at a low bit rate for playback on various devices, resulting in a smaller file size than with [**Standard**].

Therefore, you can shoot longer than with [**Standard**].

 If you change the [**📶3: Video system**] setting, set the movie recording size again.

**Total Movie Recording Time and File Size Per Minute** (Approx.)

Movie Recording Size			Total Recording Time on Card			File Size
			4 GB	8 GB	16 GB	
 <b>[1920x1080]</b>	 	Standard	17 min.	35 min.	1 hr. 10 min.	216 MB/min.
		Light	43 min.	1 hr. 26 min.	2 hr. 53 min.	87 MB/min.
 <b>[1280x720]</b>		Standard	20 min.	40 min.	1 hr. 21 min.	187 MB/min.
		Light	2 hr. 5 min.	4 hr. 10 min.	8 hr. 20 min.	30 MB/min.
 <b>[640x480]</b>		Standard	57 min.	1 hr. 55 min.	3 hr. 50 min.	66 MB/min.
		Light	2 hr. 43 min.	5 hr. 26 min.	10 hr. 53 min.	23 MB/min.

● **Movie Files Exceeding 4 GB**

Even if you shoot a movie exceeding 4 GB, you can keep shooting without interruption.

During movie shooting, approx. 30 sec. before the movie reaches the 4 GB file size, the elapsed shooting time displayed in the movie shooting screen will start blinking. If you keep shooting until the movie file size exceeds 4 GB, a new movie file will be created automatically and the elapsed shooting time or time code will stop blinking.

When you play back the movie, you will have to play each movie file individually. Movie files cannot be played back automatically in consecutive order. After the movie playback ends, select the next movie to be played back.

● **Movie Shooting Time Limit**

The maximum recording time of one movie clip is 29 min. 59 sec. If the movie shooting time reaches 29 min. 59 sec., the movie shooting will stop automatically. You can start shooting a movie again by pressing the <  > button. (A new movie file starts being recorded.)

 An increase of the camera's internal temperature may cause movie shooting to stop before the maximum recording time shown in the table above (p.253).

# Shooting Miniature Effect Movies

You can shoot movies having a Miniature (diorama) effect. Select the playback speed and shoot.



## 1 Press the <Q> button.

- ▶ The Quick Control screen will appear.



## 2 Select [Miniature effect movie].

- Press the <▲> <▼> keys to select [Miniature effect movie] on the right of the screen.



## 3 Select the playback speed.

- Press the <◀> <▶> keys to select [10x], [20x], or [5x], then press <SET>.





## 4 Position the white frame over the part you want to look sharp.

- Press the <▲> <▼> keys to move the white frame over the part you want to look sharp.
- To switch the white frame's vertical / horizontal orientation, press the <Q> button (or tap [orientation] on the screen's lower right).

## 5 Shoot the movie.

- The AF method will be FlexiZone - Single to focus on the center of the white frame.
- The white frame is not displayed while you shoot.

### Playback Speed and Length (for 1-minute movie)

Speed	Playback Length
 5x (5x)	Approx. 12 sec.
 10x (10x)	Approx. 6 sec.
 20x (20x)	Approx. 3 sec.



- Sound will not be recorded.
- With Miniature effect movies, Movie Servo AF will not work.
- Miniature effect movie cannot be set if video snapshot, **RAW**+, **RAW**, or white balance bracketing is set.
- You cannot take still photos while shooting a Miniature effect movie.
- Miniature effect movies whose playback time is shorter than 1 sec. cannot be edited (p.292).

## MENU Shooting Video Snapshots

You can shoot a series of short movie clips lasting approx. 2 sec., 4 sec., or 8 sec. called video snapshots. The video snapshots can be joined together into a single movie called a video snapshot album. You can thereby show quick highlights of a trip or event.

A video snapshot album can also be played back together with background music (p.245, 297).

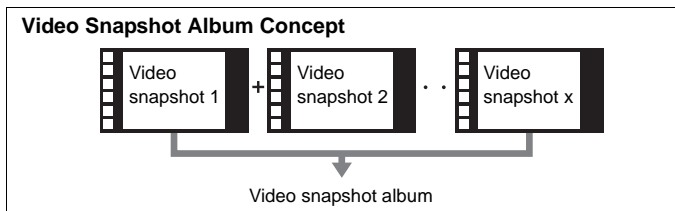

### Setting the Video Snapshot Shooting Duration

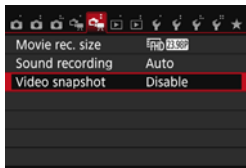

#### 1 Select [Video snapshot].

- Under the [CAM 2] tab, select [Video snapshot], then press <SET>.

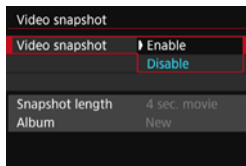

#### 2 Select [Enable].

- Select [Enable], then press <SET>.

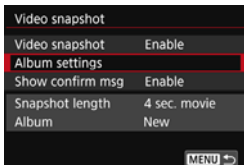

### 3 Select [Album settings].

- Select [Album settings], then press <SET>.

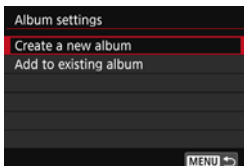

### 4 Select [Create a new album].

- Select [Create a new album], then press <SET>.

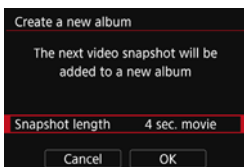

### 5 Select the snapshot length.

- Press <SET> and use the <▲> <▼> keys to select the snapshot's length, then press <SET>.



Shooting duration

### 6 Select [OK].

- Select [OK], then press <SET>.
- Press the <MENU> button to exit the menu.
- ▶ A blue bar will appear to indicate the snapshot length.
- Go to "Creating a Video Snapshot Album" (p.240).

## Creating a Video Snapshot Album



### 7 Shoot the first video snapshot.

- Press the <[CAMERA] > button, then shoot.
- ▶ The blue bar indicating the shooting duration will gradually decrease. After the set shooting duration elapses, the shooting stops automatically.
- ▶ The confirmation screen will appear (p.241-242).



### 8 Save as a video snapshot album.

- Select [ [MENU] Save as album ], then press <[SET] >.
- ▶ The movie clip will be saved as the video snapshot album's first video snapshot.



### 9 Continue to shoot more video snapshots.

- Repeat step 7 to shoot the next video snapshot.
- Select [ [MENU] Add to album ], then press <[SET] >.
- To create another video snapshot album, select [ [MENU] Save as a new album ].
- Repeat step 9 as necessary.

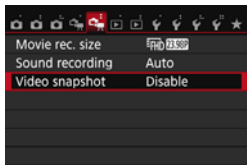







### 10 Exit the video snapshot shooting.

- Set [Video snapshot] to [Disable].  
**To return to normal movie shooting, be sure to set [Disable].**
- Press the <[MENU] > button to exit the menu, and return to the normal movie shooting.



## Options in Steps 8 and 9









Function	Description
 <b>Save as album</b> (Step 8)	The movie clip will be saved as the video snapshot album's first video snapshot.
 <b>Add to album</b> (Step 9)	The video snapshot just recorded will be added to the album recorded immediately before.
 <b>Save as a new album</b> (Step 9)	A new video snapshot album is created and the movie clip is saved as the first video snapshot. The new album will be a different file from the previously recorded album.
 <b>Playback video snapshot</b> (Steps 8 and 9)	The video snapshot just recorded will be played back. For playback operations, see the table on the next page.
 <b>Do not save to album</b> (Step 8)  <b>Delete without saving to album</b> (Step 9)	The video snapshot just recorded will be erased instead of being saved to the album. Select [OK] on the confirmation dialog.



Video snapshot	
Video snapshot	Enable
Album settings	
Show confirm msg	Disable
Snapshot length	4 sec. movie
Album	New
MENU →	

If you want to shoot another video snapshot right after shooting one video snapshot, set [Show confirm msg] to [Disable]. This setting will allow you to immediately shoot the next video snapshot without the confirmation screen appearing after you shoot each time.

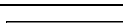
## [Playback video snapshot] Operations in Steps 8 and 9

Function	Playback Description
 <b>Play</b>	By pressing <SET>, you can play back or pause the video snapshot recorded immediately before.
 <b>First frame</b>	Displays the first scene of the album's first video snapshot.
 <b>Skip backward*</b>	Each time you press <SET>, the video snapshot skips back by a few seconds.
 <b>Previous frame</b>	Each time you press <SET>, the previous frame is displayed. If you hold down <SET>, it will rewind the movie.
 <b>Next frame</b>	Each time you press <SET>, the movie will play frame-by-frame. If you hold down <SET>, it will fast forward the movie.
 <b>Skip forward*</b>	Each time you press <SET>, the video snapshot skips forward by a few seconds.
 <b>Last frame</b>	Displays the last scene of the album's last video snapshot.
	Playback position
<b>mm' ss"</b>	Playback time (minutes:seconds)
 <b>Volume</b>	You can adjust the built-in speaker's (p.290) volume by turning the <VOLUME> dial.
<b>MENU</b> 	Pressing the <MENU> button returns to the previous screen.

\* With [**Skip backward**] and [**Skip forward**], the skipping length corresponds to the number of seconds set under [**Video snapshot**] (approx. 2 sec., 4 sec., or 8 sec.).

## Adding to an Existing Album

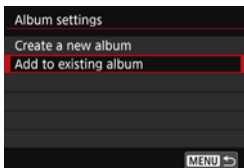

### 1 Select [Add to existing album].

- Follow step 4 on page 239 to select [Add to existing album], then press <SET>.

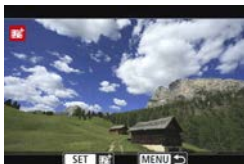

### 2 Select an existing album.

- Press the <◀> <▶> keys to select an existing album, then press <SET>.
- Select [OK], then press <SET>.
- ▶ Certain video snapshot settings will change to match the existing album's settings.
- Press the <MENU> button to exit the menu.
- ▶ The video snapshot shooting screen will appear.

### 3 Shoot the video snapshot.

- See "Creating a Video Snapshot Album" (p.240) to shoot the video snapshot.



You cannot select an album shot with another camera.

### Cautions for Shooting Video Snapshots

- You can add to an album only video snapshots with the same duration (approx. 2 sec., 4 sec., or 8 sec. each).
- Note that if you do any of the following while shooting video snapshots, a new album will be created for subsequent video snapshots.
  - Changing the **[Movie rec. size]**.
  - Changing the **[Sound rec.]** setting from **[Auto]/[Manual]** to **[Disable]** or from **[Disable]** to **[Auto]/[Manual]**.
  - Updating the firmware.
- You cannot take still photos while shooting a video snapshot.
- The shooting duration of a video snapshot is only approximate. Depending on the frame rate, the shooting duration displayed during playback may not be exact.

## Playing back an Album

You can play back a video snapshot album in the same way as a normal movie (p.290).



### 1 Play back the movie.

- Press the <▶> button to display an image.

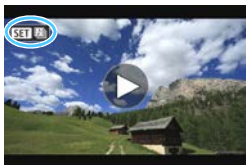

### 2 Select the album.

- In the single-image display, the [SET >] icon displayed on the upper left of the screen indicates a video snapshot album.
- Press the <◀> <▶> keys to select an album.



### 3 Play back the album.

- Press <SET>.
- On the movie playback panel displayed, select [▶] (Play), then press <SET>.



## Background Music

- You can play background music when you play back albums, normal movies, and slide shows on the camera (p.291, 294). To play background music, you must first copy the background music to the card using EOS Utility (EOS software). For information on how to copy the background music, refer to the EOS Utility Instruction Manual (p.406).
- Music recorded on the memory card must be used only for private enjoyment. Do not violate the rights of the copyright holder.

## Editing an Album

After shooting, you can rearrange, delete, or play back the video snapshots in the album.



### 1 Select [X].

- On the movie playback panel displayed, select [X] (Edit), then press <SET>.
- The editing screen will be displayed.



### 2 Select an editing operation.

- Select an editing option, then press <SET>.

Function	Description
↔ Move snapshot	Press the <◀> <▶> keys to select the video snapshot you want to move, then press <SET>. Press the <◀> <▶> keys to move the snapshot, then press <SET>.
🗑 Delete snapshot	Press the <◀> <▶> keys to select the video snapshot you want to delete, then press <SET>. The [🗑] icon will be displayed on the selected video snapshot. Pressing <SET> again will cancel the selection and [🗑] will disappear.
▶ Play snapshot	Press the <◀> <▶> keys to select the video snapshot you want to play, then press <SET>.



### 3 Save the edited album.

- Press the <MENU> button to return to the Editing panel at the screen's bottom.
- Select [] (Save), then press <SET>.
- ▶ The save screen will appear.
- To save it as a new album, select [**New file**]. To save it and overwrite the original album, select [**Overwrite**], then press <SET>.



- If the card does not have enough free space, [**New file**] will not be available.
- When the battery level is low, editing albums is not possible. Use a fully-charged battery.

## MENU Menu Function Settings

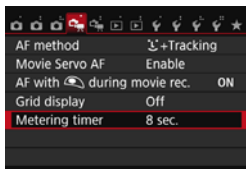

When you set the power switch to <P>, the [1] and [2] tabs will show functions dedicated to movie shooting.

### ● AF method

The AF methods are the same as described on pages 206-213. You can select [**+Tracking**], [**FlexiZone - Multi**], or [**FlexiZone - Single**].

### ● Movie Servo AF

During movie shooting, the camera focuses on the subject continuously. The default setting is [**Enable**].

#### When [**Enable**] is set:

- The camera focuses on the subject continuously even when you are not pressing the shutter button halfway.
- Since this drives the lens continuously, it will consume battery power and shorten the total possible movie shooting time (p.235).
- With certain lenses, the lens operation noise during focusing may be recorded. If this happens, use an external microphone (commercially available) to reduce lens operation noise in the movie. Also, using certain STM lenses (for example, the EF-S18-55mm f/3.5-5.6 IS STM) will reduce lens operation noise.
- If you want to set the lens's focus mode switch to <MF> during Movie Servo AF, first set the power switch to <ON>.



- If you want to keep the focus at a specific point, or if you do not want the lens operation noise to be recorded, you can temporarily stop Movie Servo AF as follows. When you stop Movie Servo AF, the AF point will turn gray. When you perform the same steps below, Movie Servo AF will resume.
  - Press the <⚡> button.
  - Tap the [SERVO AF] icon on the lower left of the screen.
  - If [10: Shutter/AE lock button] is set to [2: AF/AF lock, no AE lock] in the [4: Custom Functions (C.Fn)], you can pause the Movie Servo AF while holding down the <★> button. When you let go of the <★> button, Movie Servo AF will resume.
- When Movie Servo AF is paused, if you return to movie shooting after pressing the <MENU> or <▶> button, Movie Servo AF will resume.

#### When [Disable] is set:

- Press the shutter button halfway to focus.



#### Cautions When [Movie Servo AF] is Set to [Enable]

- **Shooting Conditions that Make Focusing Difficult**
  - A fast-moving subject approaching or moving away from the camera.
  - A subject moving at a close distance in front of the camera.
  - Also see “Shooting Conditions that Make Focusing Difficult” on page 212.
- Movie Servo AF will pause during zooming or in magnified view.
- During movie shooting, if a subject approaches or moves away or if the camera is moved vertically or horizontally (panning), the recorded movie image may momentarily expand or contract (change in image magnification).

### ● AF with shutter button during movie recording

While shooting a movie, you can also take a still photo by pressing the shutter button completely. By default, AF operation is set to **[One-Shot AF]**.

#### When **[One-Shot AF]** is set:

- You can refocus and shoot a still photo by pressing the shutter button halfway while shooting a movie.
- When shooting a still subject, you can perform shooting in precise focus.

#### When **[Disable]** is set:

- You can immediately start shooting a still photo by pressing the shutter button, even though focus is not achieved. This is effective when you want to give priority to the shooting opportunity rather than to focusing.

### ● Grid display

With **[Grid 1  $\equiv$ ]** or **[Grid 2  $\equiv$ ]**, you can display grid lines. You can check horizontal or vertical tilt when shooting.

### ● Metering timer<sup>☆</sup>

You can change how long the exposure setting is displayed (AE lock time).

## 2

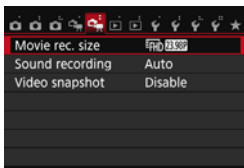

### ● Movie recording size

You can set the movie recording size (image size, frame rate, and compression method). For details, see pages 233-235.

## ● Sound recording ☆

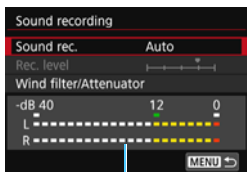

Level meter

Normally, the built-in microphones will record stereo sound. If a commercially-available external stereo microphone equipped with a mini plug (3.5 mm diameter) is connected to the camera's external microphone IN terminal (p.26), it will be given priority.

### [Sound rec./Rec. level] options

- [Auto]** : The sound-recording level is adjusted automatically. Auto level control will operate automatically in response to the sound level.
- [Manual]** : For advanced users. You can adjust the sound-recording level to one of 64 levels. Select **[Rec. level]** and look at the level meter while pressing the <◀> <▶> keys to adjust the sound-recording level. Look at the peak hold indicator (approx. 3 sec.), and adjust so that the level meter sometimes lights up on the right of the "12" (-12 dB) mark for the loudest sounds. If it exceeds "0", the sound will be distorted.
- [Disable]** : Sound will not be recorded.

### [Wind filter]

When set to **[Auto]**, it reduces wind noise when there is wind outdoors. This feature takes effect only with the built-in microphones. When the wind filter function takes effect, low bass sounds will also be reduced.

### [Attenuator]

Even if you set **[Sound recording]** to **[Auto]** or **[Manual]** before shooting, sound distortion may still result if there is a very loud sound. In such a case, setting it to **[Enable]** is recommended.



- In Basic Zone modes, the settings available for **[Sound recording]** will be **[On]** or **[Off]**. If **[On]** is set, the sound-recording level will be adjusted automatically (same as with **[Auto]**), and the wind filter function will take effect.
  - The sound volume balance between L (left) and R (right) cannot be adjusted.
  - Both L and R record audio at a 48 kHz/16-bit sampling rate.
- **Video snapshots**  
You can shoot video snapshots. For details, see page 238.



## General Movie Shooting Cautions

### White <[Icon]> and Red <[Icon]> Internal Temperature Warning Icons

- If the camera's internal temperature increases due to prolonged movie shooting or under a high ambient temperature, a white <[Icon]> or red <[Icon]> icon will appear.
- The white <[Icon]> icon indicates that the image quality of still photos will deteriorate. It is recommended that you stop still photo shooting for a while and allow the camera to cool down. Since movie image quality will hardly be affected, you can still shoot movies.
- The red <[Icon]> icon indicates that movie shooting will soon be terminated automatically. If this happens, you will not be able to shoot again until the camera's internal temperature decreases. Turn off the power and let the camera rest for a while.
- Shooting a movie at a high temperature for a prolonged period will cause the <[Icon]> or <[Icon]> icon to appear earlier. When you are not shooting, always turn off the camera.

### Recording and Image Quality

- If the attached lens has an Image Stabilizer and you set the Image Stabilizer (IS) switch to <ON>, the Image Stabilizer will operate at all times even if you do not press the shutter button halfway. The Image Stabilizer consumes battery power and may shorten the total movie shooting time or decrease the number of possible shots. If you use a tripod or if the Image Stabilizer is not necessary, it is recommended to set the IS switch to <OFF>.
- The camera's built-in microphones will also pick up camera operation noise. Use an external microphone (commercially available) to reduce camera operation noise in the movie.
- Do not connect anything other than an external microphone to the camera's external microphone IN terminal.
- If the brightness changes during autoexposure movie shooting, the movie may freeze temporarily. In such cases, shoot movies with manual exposure.
- If there is a very bright light source in the image, the bright area may appear black on the LCD monitor. The movie will be recorded almost exactly as it appears on the LCD monitor.
- In low light, noise or irregular colors may appear in the image. The movie will be recorded almost exactly as it appears on the LCD monitor.
- If you play back a movie with other devices, image or sound quality may deteriorate or playback may not be possible (even if the devices support MP4 format).

## General Movie Shooting Cautions

### Recording and Image Quality

- If you use a card with a slow writing speed, a five-level indicator may appear on the right of the screen during movie shooting. It indicates how much data has not yet been written to the card (remaining capacity of the internal buffer memory). The slower the card, the faster the indicator will climb upward. If the indicator becomes full, movie shooting will stop automatically.

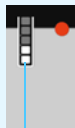

Indicator

If the card has a fast writing speed, the indicator will either not appear or the level (if displayed) will hardly go upward.

First, shoot a few test movies to see if the card can write fast enough.

### Still Photo Shooting During Movie Shooting

- Regarding the image quality of still photos, see “Image Quality” on page 218.

### Playback and TV Connection

- If you connect the camera to a TV set (p.298-301) and shoot a movie, the TV set will not output any sound during the shooting. However, the sound will be properly recorded.

## Restrictions on MP4-format Movies

Note that generally the following restrictions apply to MP4-format movies.

- Sound will not be recorded on approx. the last two frames.
- When you play back movies on Windows, images and sound may become slightly out of synchronization.

# 9

## Handy Features

- Disabling the Beeper (p.256)
- Card Reminder (p.256)
- Setting the Image Review Time (p.257)
- Setting the Auto Power-off Time (p.257)
- Adjusting the LCD Monitor Brightness (p.258)
- Creating and Selecting a Folder (p.259)
- File Numbering Methods (p.261)
- Setting Copyright Information (p.263)
- Auto Rotation of Vertical Images (p.265)
- Checking Camera Settings (p.266)
- Reverting the Camera to the Default Settings (p.267)
- LCD Monitor Off/On Setting (p.270)
- Changing the Shooting Settings Screen Color (p.270)
- Automatic Sensor Cleaning (p.271)
- Appending Dust Delete Data (p.272)
- Manual Sensor Cleaning (p.274)

## Handy Features

### MENU Disabling the Beeper

You can prevent the beeper from sounding when focus is achieved during self-timer shooting and touch screen operations.



Under the [**1**] tab, select [**Beep**], then press < (SET) >. Select [**Disable**], then press < (SET) >.

To silence the beeper only during touch screen operations, select [**Touch to** [speaker icon]].

### MENU Card Reminder

This setting prevents shooting if there is no card in the camera.

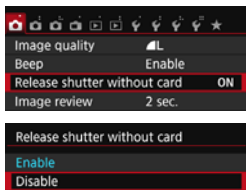

Under the [**1**] tab, select [**Release shutter without card**], then press < (SET) >. Select [**Disable**], then press < (SET) >.

If there is no card inserted in the camera and you press the shutter button, “**Card**” will be displayed in the viewfinder, and you cannot release the shutter.



## **MENU** Setting the Image Review Time

You can set how long the image is displayed on the LCD monitor just after shooting. If **[Off]** is set, the image will not be displayed just after shooting. If **[Hold]** is set, the image review will be displayed up until the **[Auto power off]** time has elapsed.

During image review, if you operate any camera controls such as pressing the shutter button halfway, the image review will end.

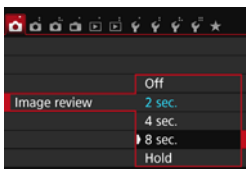

Under the **[📷 1]** tab, select **[Image review]**, then press **<SET>**. Select the desired setting, then press **<SET>**.

## **MENU** Setting the Auto Power-off Time

To save battery power, the camera turns off automatically after the set time of idle operation elapses. You can set this auto power-off time. When the camera is turned off due to auto power off, you can turn it on again by pressing the shutter button, etc.

**If [Disable] is set, either turn off the camera or press the <DISP.> button to turn off the LCD monitor to save battery power.**

**Even when [Disable] is set, if the camera is not used for 30 min., the LCD monitor will turn off automatically. To turn on the LCD monitor again, press the <DISP.> button.**

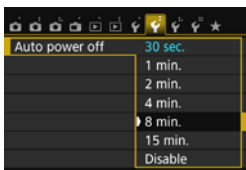

Under the **[🔧 2]** tab, select **[Auto power off]**, then press **<SET>**. Select the desired setting, then press **<SET>**.

## **MENU** Adjusting the LCD Monitor Brightness

You can adjust the brightness of the LCD monitor to make it easier to read.

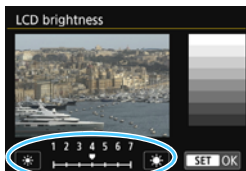
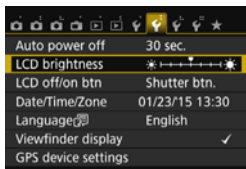

Under the [**2**] tab, select [**LCD brightness**], then press <SET>. Press the <◀> <▶> keys to adjust the brightness on the adjustment screen, then press <SET>.

When checking the exposure of an image, set the LCD monitor brightness to 4 and prevent the ambient light from affecting the image.

## MENU Creating and Selecting a Folder

You can freely create and select the folder where the captured images are to be saved.

This operation is optional since a folder will be created automatically for saving captured images.

### Creating a Folder

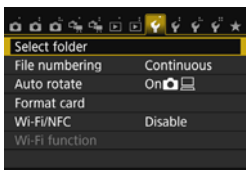

- 1 **Select [Select folder].**
  - Under the [1] tab, select [Select folder], then press <SET>.

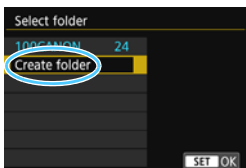

- 2 **Select [Create folder].**
  - Select [Create folder], then press <SET>.

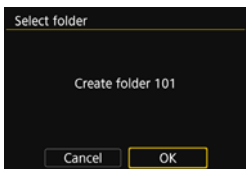

- 3 **Create a new folder.**
  - Select [OK], then press <SET>.
  - ▶ A new folder with the folder number increased by one is created.

## Selecting a Folder

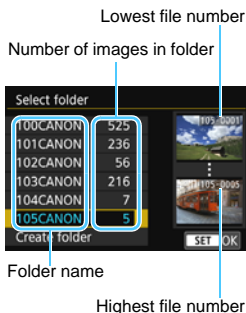

- With the folder selection screen displayed, select a folder and press < (SET) >.
- ▶ The folder where the captured images will be saved is selected.
- Subsequent captured images will be recorded into the selected folder.



## Folders

As with “100CANON” for example, the folder name starts with three digits (the folder number) followed by five alphanumeric characters. A folder can contain up to 9999 images (file number 0001 - 9999). When a folder becomes full, a new folder with the folder number increased by one is created automatically. Also, if manual reset (p.262) is executed, a new folder will be created automatically. Folders numbered from 100 to 999 can be created.

## Creating Folders with a Computer

With the card open on the screen, create a new folder named “DCIM”. Open the DCIM folder and create as many folders as necessary to save and organize your images. The folder name must follow the format “100ABC\_D”. The first three digits are the folder number, from 100 to 999. The last five characters can be any combination of upper- and lower-case letters from A to Z, numerals, and the underscore “\_”. The space cannot be used. Also note that two folder names cannot share the same three-digit folder number (for example, “100ABC\_D” and “100W\_XYZ”), even if the last five characters in each name are different.

## MENU File Numbering Methods

The image files will be numbered from 0001 to 9999 in the order the images are taken, then saved in a folder. You can change how the file number is assigned.

The file number will appear on your computer in this format:

**IMG\_0001.JPG.**

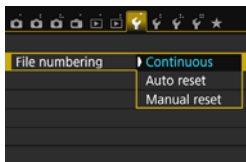

Under the [**F1**] tab, select [**File numbering**], then press <SET>. The available settings are described below. Select the option, then press <SET>.

- **[Continuous]: The file numbering continues in sequence even after you replace the card or create a folder.**

Even after you replace the card or create a new folder, the file numbering continues in sequence up to 9999. This is convenient when you want to save images numbered anywhere between 0001 to 9999 on multiple cards or in multiple folders into one folder on your computer.

If the replacement card or existing folder already contains images recorded previously, the file numbering of the new images may continue from the file numbering of the existing images on the card or in the folder. If you want to use continuous file numbering, it is recommended that you use a newly-formatted card each time.

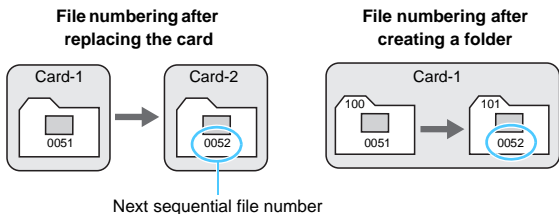

- **[Auto reset]: The file numbering restarts from 0001 each time the card is replaced or a new folder is created.**

When you replace the card or create a folder, the file numbering restarts from 0001 for the new images saved. This is convenient if you want to organize images by cards or folders.

If the replacement card or existing folder already contains images recorded previously, the file numbering of the new images may continue from the file numbering of the existing images on the card or in the folder. If you want to save images with the file numbering starting from 0001, use a newly formatted card each time.

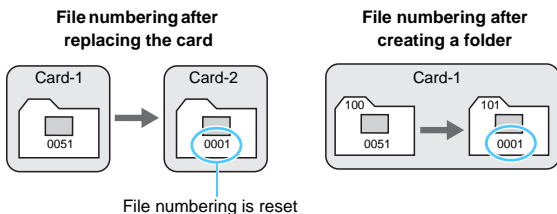

- **[Manual reset]: To reset the file numbering to 0001 manually or to start from file number 0001 in a new folder.**

When you reset the file numbering manually, a new folder is created automatically and the file numbering of images saved to that folder starts from 0001.

This is convenient if you want to use different folders for the images taken yesterday and the ones taken today, for example. After the manual reset, the file numbering returns to continuous or auto reset. (There will be no manual reset confirmation dialog.)

- If the file number in folder 999 reaches 9999, shooting will not be possible even if the card still has storage capacity. The LCD monitor will display a message telling you to replace the card. Replace it with a new card.

- For both JPEG and RAW images, the file name will start with "IMG\_". Movie file names will start with "MVI\_". The extension will be ".JPG" for JPEG images, ".CR2" for RAW images, and ".MP4" for movies.

## MENU Setting Copyright Information ☆

When you set the copyright information, it will be appended to the image as Exif information.

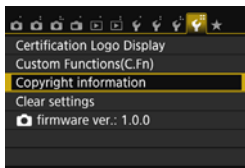

### 1 Select [Copyright information].

- Under the [**4**] tab, select [**Copyright information**], then press <SET>.

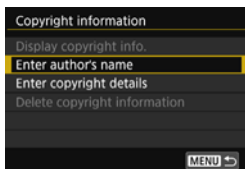

### 2 Select the option to be set.

- Select [**Enter author's name**] or [**Enter copyright details**], then press <SET>.
- ▶ The text entry screen will appear.
- Select [**Display copyright info.**] to check the copyright information currently set.
- Select [**Delete copyright information**] to delete the copyright information currently set.



### 3 Enter text.

- See "Text Entry Procedure" on the next page and enter the copyright information.
- Enter up to 63 alphanumeric characters and symbols.

### 4 Exit the setting.

- After entering the text, press the <MENU> button to exit.
- On the confirmation dialog, select [**OK**], then press <SET>.

## Text Entry Procedure



- **Changing the Entry Area:**  
Press the <Q> button to toggle between the top and bottom entry areas.
- **Moving the Cursor:**  
Press the <◀> <▶> keys in the top area to move the cursor.

- **Entering Text:**

In the bottom area, press the <⬆> cross keys or turn the <☀> dial to select a character, then press <SET> to enter it.

- **Changing the Entry Mode:\***

Select [Aa=1@] at the bottom right of the bottom entry area. Each time you press <SET>, the entry mode will change as follows: Lower case → Numerals / Symbols 1 → Numerals / Symbols 2 → Upper case.

\* When [Touch control: Disable] is set, you can enter all characters on one screen.

- **Deleting a Character:**

Press the <☒> button to delete one character.

- **Finishing the Text Entry:**

Press the <MENU> button, check the text, select [OK], then press <SET>. The screen in step 2 will reappear.

- **Canceling the Text Entry:**

Press the <INFO.> button, check the text, select [OK], then press <SET>. The screen in step 2 will reappear.

 You can also set or check the copyright information with EOS Utility (EOS software, p.404).



## MENU Auto Rotation of Vertical Images



Vertical images are rotated automatically so they are displayed vertically on the camera's LCD monitor and on the computer instead of horizontally. You can change the setting for this feature.

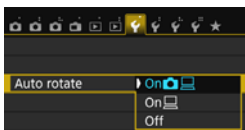

Under the [**1**] tab, select [**Auto rotate**], then press <SET>. The available settings are described below. Select the option, then press <SET>.

- [**On [camera icon] [computer icon]**] : The vertical image is automatically rotated during playback on both the camera's LCD monitor and on the computer.
- [**On [computer icon]**] : The vertical image is automatically rotated only on the computer.
- [**Off**] : The vertical image is not automatically rotated.

## ? FAQ

- **The vertical image is not rotated during the image review just after shooting.**  
Press the <▶> button and the image playback will display the rotated image.
- **[On [camera icon] [computer icon]] is set, but the image does not rotate during playback.**  
Auto rotate will not work with vertical images captured while [**Auto rotate**] was set to [**Off**]. If the vertical image is taken while the camera is pointed up or down, the image may not be rotated automatically for playback. In such a case, see "Rotating the Image" on page 283.
- **On the camera's LCD monitor, I want to rotate an image captured when [On [computer icon]] had been set.**  
Set [**On [camera icon] [computer icon]**], then play back the image. It will be rotated.
- **The vertical image does not rotate on the computer screen.**  
The software used is not compatible with image rotation. Use EOS software instead.

## INFO.: Checking Camera Settings

When the shooting settings (p.28) are displayed, you can check the current settings of camera's major functions by pressing the <INFO.> button.



### Settings display

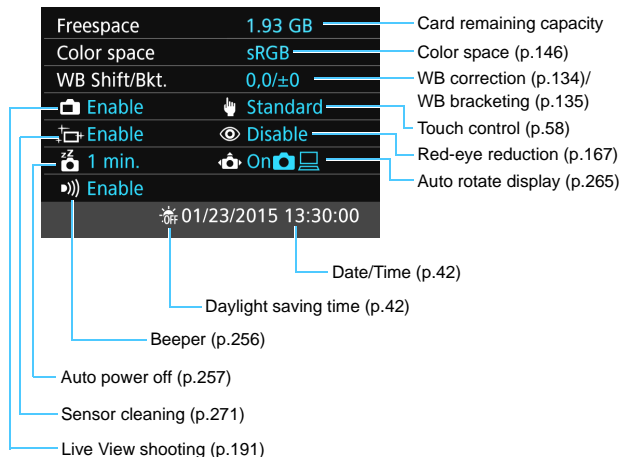

## **MENU** Reverting the Camera to the Default Settings <sup>☆</sup>

The camera's shooting function settings and menu settings can be reverted to their defaults. This option is available in Creative Zone modes.

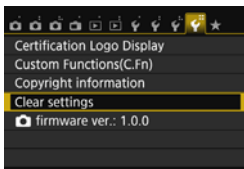

- 1 **Select [Clear settings].**
  - Under the [**4**] tab, select [**Clear settings**], then press <SET>.

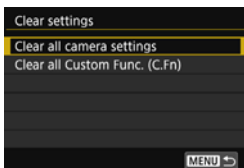

- 2 **Select [Clear all camera settings].**
  - Select [**Clear all camera settings**], then press <SET>.

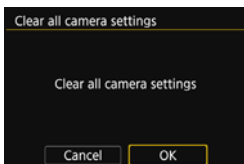



- 3 **Select [OK].**
  - Select [**OK**], then press <SET>.
  - ▶ Setting [**Clear all camera settings**] will reset the camera to the default settings as shown on pages 268-269.



## **? FAQ**

- **Clearing all camera settings**  
After the procedure above, select [**Clear all Custom Func. (C.Fn)**] in [**4: Clear settings**] to clear all the Custom Function settings (p.336).





## Shooting Function Settings

<SCN> mode	 (Kids)
AF operation	One-Shot AF
AF area selection mode	Auto selection: 19 pt AF
Drive mode	<input type="checkbox"/> (Single shooting)
Metering mode	 (Evaluative metering)
ISO speed	AUTO (Auto)
ISO Auto	Maximum 6400
Exposure compensation / AEB	Canceled
Flash exposure compensation	0 (Zero)
Red-eye reduction	Disable
Anti-flicker shooting	Disable
Aspect ratio	3 : 2
Viewfinder display	Display only flicker detection
Custom Functions	Unchanged
Flash control	
Flash firing	Enable
E-TTL II flash metering	Evaluative flash metering
Flash sync. speed in Av mode	Auto

## Image Recording Settings

Image quality	
Picture Style	Auto
Auto Lighting Optimizer	Standard
Peripheral illumination correction	Enable / Correction data retained
Chromatic aberration correction	Enable / Correction data retained
Distortion correction	Disable / Correction data retained
Color space	sRGB
White balance	 (Auto)
Custom White Balance	Canceled
White balance correction	Canceled
White balance bracketing	Canceled
Long exposure noise reduction	Disable
High ISO speed noise reduction	Standard
File numbering	Continuous
Auto cleaning	Enable
Dust Delete Data	Erase



## Camera Settings

Auto power off	30 sec.
Beep	Enable
Release shutter without card	Enable
Image review	2 sec.
AF point display	Disable
Histogram display	Brightness
Image jump with 	 (10 images)
Auto rotate	On  
LCD brightness	
LCD off/on button	Shutter button
Date/Time/Zone	Unchanged
Language	Unchanged
Video system	Unchanged
Screen color	1
Feature guide	Enable
Touch control	Standard
Copyright information	Unchanged
Control over HDMI	Disable
Eye-Fi transmission	Disable
My Menu settings	Unchanged
Display from My Menu	Disable
Wi-Fi/NFC	Disable
Wi-Fi function	Unchanged

## Live View Shooting Settings

Live View shooting	Enable
AF method	 +Tracking
Continuous AF	Enable
Touch Shutter	Disable
Grid display	Off
Metering timer	8 sec.

## Movie Shooting Settings

AF method	 +Tracking
Movie Servo AF	Enable
AF with shutter button during movie recording	One-Shot AF
Grid display	Off
Metering timer	8 sec.
Movie recording size	NTSC:  29.97P (Standard) PAL:  25.00P (Standard)
Sound recording	Auto
Video snapshot	Disable



For Wi-Fi/NFC settings, refer to the Wi-Fi/NFC Function Instruction Manual.

## MENU LCD Monitor Off/On Setting

You can set the camera, so that the shooting settings display (p.28) does not turn on and off as you press the shutter button halfway (or press the <★> button/Depth-of-field preview button).

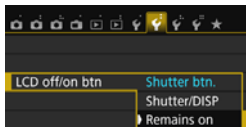

Under the [F2] tab, select [LCD off/on btn], then press <SET>. The available settings are described below. Select one, then press <SET>.

- [Shutter btn.] : When you press the shutter button halfway, the display will turn off. And when you let go of the shutter button, the display will turn on.
- [Shutter/DISP]: When you press the shutter button halfway, the display will turn off. And when you let go of the shutter button, the display remains off. To turn on the display, press the <DISP.> button.
- [Remains on] : Display remains on even when you press the shutter button halfway. To turn off the display, press the <DISP.> button.

## MENU Changing the Shooting Settings Screen Color

You can change the background color of the shooting settings screen.

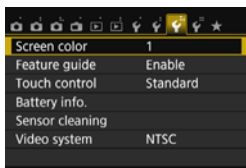

Under the [F3] tab, select [Screen color], then press <SET>. Select the desired color, then press <SET>.

When you exit the menu, the shooting settings screen based in the selected color will be displayed.



## Automatic Sensor Cleaning

Whenever you set the power switch to <ON> or <OFF>, the Self Cleaning Sensor Unit operates to automatically shake off the dust on the front of the sensor. Normally, you need not pay attention to this operation. However, you can choose to perform sensor cleaning manually, or disable it.

### Cleaning the Sensor Now

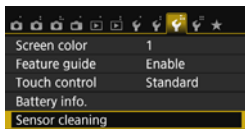

#### 1 Select [Sensor cleaning].

- Under the [**3**] tab, select [**Sensor cleaning**], then press <SET>.

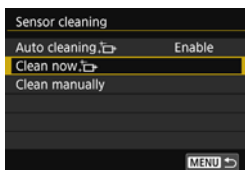

#### 2 Select [Clean now ].

- Select [**Clean now **], then press <SET>.
- Select [**OK**], then press <SET>.
- ▶ The screen will indicate that the sensor is being cleaned. (A small sound may be heard.) Although there will be a shutter sound, no picture is taken.



- For best results, perform the sensor cleaning with the camera placed upright and stable on a table or other flat surface.
- Even if you repeat the sensor cleaning, the result will not improve much. Immediately after the sensor cleaning is finished, the [**Clean now **] option remains disabled temporarily.

### Disabling Automatic Sensor Cleaning

- In step 2, select [**Auto cleaning **] and set it to [**Disable**].
- ▶ The sensor cleaning will no longer be executed when you set the power switch to <ON> or <OFF>.

## MENU Appending Dust Delete Data <sup>☆</sup>

Normally, the Self Cleaning Sensor Unit will eliminate most of the dust that may be visible on captured images. However, in case visible dust still remains, you can append the Dust Delete Data to the image for erasing the dust spots later. The Dust Delete Data is used by Digital Photo Professional (EOS software, p.404) to erase the dust spots automatically.

### Preparation

- Prepare a solid white object such as a sheet of paper.
- Set the lens focal length to 50 mm or longer.
- Set the lens focus mode switch to **<MF>** and set the focus to infinity ( $\infty$ ). If the lens has no distance scale, rotate the camera to face towards you and turn the focusing ring clockwise all the way.

### Obtaining the Dust Delete Data

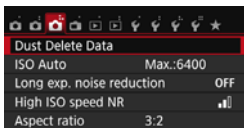

#### 1 Select [Dust Delete Data].

- Under the [**3**] tab, select [**Dust Delete Data**], then press **<SET>**.

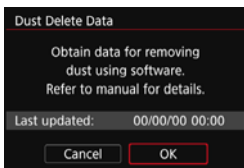

#### 2 Select [OK].

- Select [**OK**] and press **<SET>**. After the automatic self-cleaning of the sensor is performed, a message will appear. Although there will be a shutter sound during the cleaning, no picture is taken.

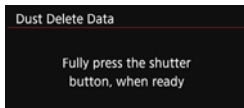
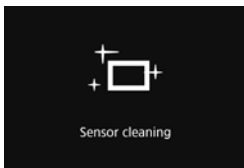





### 3 Shoot a solid-white object.

- At a distance of 20 cm - 30 cm (0.7 ft. - 1.0 ft.), fill the viewfinder with a patternless, solid-white object and take a picture.
- ▶ The picture will be taken in aperture-priority AE mode at an aperture of f/22.
- Since the image will not be saved, the data can still be obtained even if there is no card in the camera.
- ▶ When the picture is taken, the camera will start collecting the Dust Delete Data. When the Dust Delete Data is obtained, a message will appear. Select **[OK]** and the menu will reappear.
- If the data is not obtained successfully, an error message will appear. Follow the “Preparation” procedure on the preceding page, then select **[OK]**. Take the picture again.

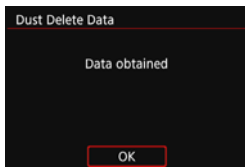

## Dust Delete Data

After the Dust Delete Data is obtained, it is appended to all the JPEG and RAW images captured thereafter. Before an important shoot, it is recommended to update the Dust Delete Data by obtaining it again. For details about using Digital Photo Professional (EOS software) to erase dust spots, refer to the Digital Photo Professional Instruction Manual (p.406).

The Dust Delete Data appended to the image is so small that it hardly affects the image file size.

 Be sure to use a solid-white object such as a new sheet of white paper. If the object has any pattern or design, it may be recognized as dust data and affect the accuracy of the dust deletion with EOS software.

## MENU Manual Sensor Cleaning ☆

Dust that could not be removed by the automatic sensor cleaning can be removed manually with a commercially-available blower, etc. Before cleaning the sensor, detach the lens from the camera.

**The image sensor is extremely delicate. If the sensor needs to be cleaned directly, having it done by a Canon Service Center is recommended.**

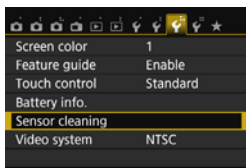

### 1 Select [Sensor cleaning].

- Under the [**3**] tab, select [**Sensor cleaning**], then press <SET>.

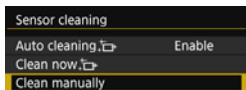

### 2 Select [Clean manually].

- Select [**Clean manually**], then press <SET>.



### 3 Select [OK].

- Select [**OK**], then press <SET>.
- ▶ In a moment, the reflex mirror will lockup and the shutter will open.

### 4 Clean the sensor.

### 5 End the cleaning.

- Set the power switch to <OFF>.

 If you use a battery, make sure it is fully charged.

 For the power source, using AC Adapter Kit ACK-E18 (sold separately) is recommended.



- **While cleaning the sensor, never do any of the following. If the power is cut off, the shutter will close and the shutter curtains and image sensor may get damaged.**
  - **Setting the power switch to <OFF>.**
  - **Removing or inserting the battery.**
- The surface of the image sensor is extremely delicate. Clean the sensor with care.
- Use a plain blower without any brush attached. A brush can scratch the sensor.
- Do not insert the blower tip inside the camera beyond the lens mount. If the power is turned off, the shutter will close and the shutter curtains or reflex mirror may get damaged.
- Never use pressurized air or gas to clean the sensor. The blowing force can damage the sensor, or the spray gas can freeze on the sensor and scratch it.
- If the battery level becomes low while cleaning the sensor, the beeper will sound as a warning. Stop cleaning the sensor.
- If a smudge that cannot be removed with a blower remains, having the sensor cleaned by a Canon Service Center is recommended.



# 10

## Image Playback

This chapter explains functions related to viewing photos and movies, with more advanced uses than in Chapter 2 “Basic Shooting and Image Playback”. Here you will find explanations of how to play back and erase photos and movies with the camera and view them on a TV set.

### **Images shot and saved with another device**

The camera may not be able to properly display images captured with a different camera, edited with a computer, or that have had their file names changed.

## ▶ Searching for Images Quickly

### ▣ Displaying Multiple Images on One Screen (Index Display)

Search for images quickly with the index display showing 4, 9, 36, or 100 images on one screen.



#### 1 Play back the image.

- When you press the <▶> button, the last image captured will be displayed.



#### 2 Switch to the index display.

- Press the <▣·🔍> button.
- ▶ The 4-image index display will appear. The selected image is highlighted with an orange frame.
- Pressing the <▣·🔍> button will switch the display as follows: 9 images → 36 images → 100 images.
- Pressing the <🔍> button will switch the display as follows: 100 images → 36 images → 9 images → 4 images → 1 image.



#### 3 Select an image.

- Press the <⬆> cross keys to move the orange frame to select the image.
- Turning the <🌓> dial will display image(s) on the next or previous screen.
- Press <Ⓢ(SET)> in the index display to display the selected image in the single-image display.

## 📷 Jumping through Images (Jump Display)

In the single-image display, you can turn the <🔘> dial to jump through the images forward or backward according to the jump method set.

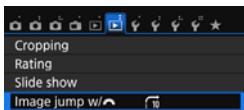

### 1 Select [Image jump w/🔘].

- Under the [▶2] tab, select [Image jump w/🔘], then press <Ⓢ>.

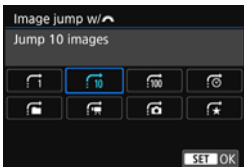

### 2 Select the jump method.

- Press the <⬆> cross keys to select the jump method, then press <Ⓢ>.

📄: Display images one by one

🔘: Jump 10 images

🔘: Jump 100 images

📅: Display by date

📁: Display by folder

🎬: Display movies only

📷: Display stills only

🌟: Display by image rating (p.284)

Turn the <🔘> dial to select.



Jump method

Playback position

### 3 Browse by jumping.

- Press the <▶> button to play back images.
- In the single-image display, turn the <🔘> dial.
- ▶ You can browse images with the method that was set.





- To search images by shooting date, select [Date].
- To search images by folder, select [Folder].
- If the card contains both movies and still photos, select [Movies] or [Stills] to display only one or the other.
- If no images match the selected [Rating], you cannot browse through the images with the <🔘> dial.

## Magnified View

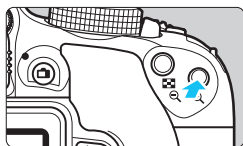
You can magnify a captured image by approx. 1.5x to 10x on the LCD monitor.



### 1 Magnify the image.



- Press the  button during image playback.
- ▶ The image will be magnified.
- If you hold down the  button, the image will be magnified until it reaches the maximum magnification.
- Press the  button to reduce the magnification. If you hold down the button, the magnification will be reduced to the single-image display.



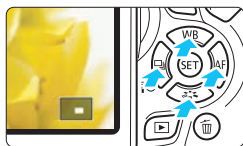

Magnified area position



### 2 Scroll around the image.

- Use the  cross keys to scroll the magnified image in the direction pressed.
- To exit magnified view, press the  button and the single-image display will reappear.



-  In magnified view, you can turn the  dial to view another image at the same magnification.
- The image cannot be magnified during the image review just after shooting.
- A movie cannot be magnified.



## Playing Back with the Touch Screen

The LCD monitor is a touch-sensitive panel that you can touch with your fingers for various playback operations. **First, press the <▶> button to play back images.**

### Browsing Images



#### Swipe with one finger.

- With single-image display, touch the LCD monitor with **one finger**. You can browse to the next or previous image by swiping your finger to the left or right.  
Swipe to the left to see the next (newer) image, or swipe to the right to see the previous (older) image.
- With index display, also touch the LCD monitor with **one finger**. You can browse to the next or previous screen by swiping your finger up or down.

Swipe up to see the next (newer) images or swipe down to see the previous (older) images.

When you select an image, the orange frame will appear. Tap on the image again to display it as a single image.

### Jumping through Images (Jump Display)



#### Swipe with two fingers.

Touch the LCD monitor with **two fingers**. When you swipe two fingers to the left or right, you can jump through images with the method set in [**Image jump w/** ▶2] tab.

## Reducing Image (Index Display)



### Pinch two fingers.

Touch the screen with two fingers spread apart, and pinch your fingers together on the screen.

- Each time you pinch your fingers, the single-image display will change to the index display.
- When you select an image, the orange frame will appear. Tap on the image again to display it as a single image.

## Magnifying Image



### Spread two fingers apart.

Touch the screen with two fingers together, then spread your fingers apart on the screen.

- As you spread your fingers, the image will be magnified.
- The image can be magnified up to approx. 10x.
- You can scroll around the image by dragging your fingers.
- To reduce the image, pinch your fingers together on the screen.
- Tapping on the [↶] icon will return to the single-image display.



 Touch screen operations on the camera's LCD monitor are also possible while playing back images on a TV set connected to your camera (p.298-301).

## Rotating the Image

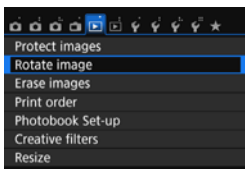
You can rotate the displayed image to the desired orientation.



### 1 Select [Rotate image].

- Under the [ 1] tab, select [Rotate image], then press < >.

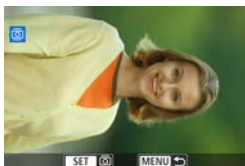

### 2 Select an image.







- Press the <◀> <▶> keys to select the image to be rotated.
- You can also select an image in the index display (p.278).



### 3 Rotate the image.

- Each time you press < >, the image will rotate clockwise as follows: 90° → 270° → 0°.
- To rotate another image, repeat steps 2 and 3.
- To exit and return to the menu, press the <MENU> button.



- If you set [ 1: Auto rotate] to [On  ] (p.265) before taking vertical shots, you need not rotate the image as described above.
- If the rotated image is not displayed in the rotated orientation during image playback, set [ 1: Auto rotate] to [On  ].
- A movie cannot be rotated.

## MENU Setting Ratings

You can rate images (still photos and movies) with one of five rating marks: [★]/[★]/[★]/[★]/[★]. This function is called rating.

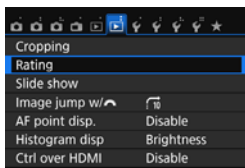

### 1 Select [Rating].

- Under the [▶] 2 tab, select [Rating], then press <SET>.



### 2 Select an image.

- Press the <◀> <▶> keys to select an image or movie to be rated, then press <SET>.
- By pressing the <☑-Q> button, you can select images from a three-image display. To return to the single-image display, press the <Q> button.



### 3 Rate the image.

- Press the <▲> <▼> keys to select a rating.
- ▶ When you select a rating for the image, the number beside the set rating will increase by one.
- To rate another image, repeat steps 2 and 3.
- To return to the menu, press the <MENU> button.













A total of up to 999 images of a given rating can be displayed. If there are more than 999 images with a given rating, [###] will be displayed.

### Taking Advantage of Ratings

- With [▶2: Image jump w/ ], you can display only images having the specified rating.
- With [▶2: Slide show], you can play back only images having the specified rating.
- With Digital Photo Professional (EOS software, p.404), you can select only images with a specific rating (still photos only).
- With Windows 8.1, Windows 8, Windows 7, etc., you can see each file's rating as part of the file information display or in the provided image viewer (still photos only).

## Quick Control for Playback

During playback, you can press the  button to set the following:  
: **Protect images**, : Rotate image, : **Rating**, : Creative filters, : Resize (JPEG images only), : Cropping, : **AF point display**, : **Image jump w/** , : **Wi-Fi function\***.

**For movies, only the functions in bold above can be set.**

\* Not selectable if [ 1: **Wi-Fi/NFC**] is set to [Disable].











### 1 Press the button.

- During image playback, press the  button.
- ▶ The Quick Control options will appear.









### 2 Select a function and set it.

- Press the   keys to select a function.
- ▶ The name and current setting of the selected function are displayed at the bottom of the screen.
- Set it by pressing the   keys.
- When setting the Creative filters (p.312), Resize (p.315), Cropping (p.317), or Wi-Fi function, also press  to finalize the setting.
- Image jump w/ : Set the Rating (p.284) by pressing the  button.
- To cancel, press the  button.

### 3 Exit the setting.

- Press the  button to exit the Quick Control screen.

 To rotate an image, set [**⚙1: Auto rotate**] to [**On**  ]. If [**⚙1: Auto rotate**] is set to [**On** ] or [**Off**], the [**Ⓚ Rotate image**] setting will be recorded to the image, but the camera will not rotate the image for display.

-  ● Pressing the <> button during the index display will switch to the single-image display and the Quick Control screen will appear. Pressing the <> button again will return to the index display.
- For images taken with another camera, the options you can select may be restricted.

## Enjoying Movies

You can play back movies in the following three ways:

### Playback on a TV Set (p.298-301)



Use the HDMI cable HTC-100 (sold separately) or stereo AV cable AVC-DC400ST (sold separately) to connect the camera to a TV set. Then you can play back captured movies and still photos on the TV set.

If you have a High-Definition TV set and connect your camera with an HDMI cable, you can watch Full High-Definition (Full HD: 1920x1080) and High-Definition (HD: 1280x720) movies with higher image quality.

- Since hard disk recorders do not have an HDMI IN terminal, the camera cannot be connected to a hard disk recorder with an HDMI cable.
- Even if the camera is connected to a hard disk recorder with a USB cable, movies and still photos cannot be played back or saved.
- If the playback device is not compatible with MP4 files, the movie cannot be played back.

### Playback on the Camera's LCD Monitor (p.290-297)



You can play back movies on the camera's LCD monitor. You can also edit out the movie's first and last scenes, and play back the still photos and movies on the card in an automatic slide show.

- A movie edited with a computer cannot be rewritten to the card or played back with the camera.



## Playback and Editing with a Computer



To play back or edit a movie, use pre-installed or general-purpose software, compatible with the movie's recording format.



If you want to play back or edit a movie with commercially-available software, use software compatible with MP4-format movies. For details on commercially-available software, contact the software manufacturer.

## 📢 Playing Back Movies



### 1 Play back the image.

- Press the <▶> button to display an image.

### 2 Select a movie.

- Press the <◀> <▶> keys to select the movie to be played back.
- In the single-image display, the <SET [▶]> icon displayed on the upper left of the screen indicates a movie. If the movie is a video snapshot, <SET [▶]> will be displayed.
- In the index display, perforations at the left edge of a thumbnail indicate a movie. **As movies cannot be played back from the index display, press <SET> to switch to the single-image display.**



### 3 In the single-image display, press <SET>.

- ▶ The movie playback panel will appear at the bottom of the screen.

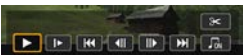





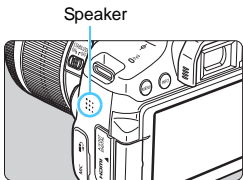





### 4 Play back the movie.

- Select [▶] (Play), then press <SET>.
- ▶ The movie will start playing back.
- You can pause the movie playback by pressing <SET>.
- You can adjust the sound volume by turning the <[Gears]> dial even during movie playback.
- For more details on the playback procedure, see the next page.



⚠ The camera may not be able to play back movies shot with another camera.

## Movie Playback Panel

Operation	Playback Description
 <b>Play</b>	Pressing <SET> toggles between play and stop.
 <b>Slow motion</b>	Adjust the slow motion speed by pressing the <◀> <▶> keys. The slow motion speed is indicated on the upper right of the screen.
 <b>First frame</b>	Displays the movie's first frame.
 <b>Previous frame</b>	Each time you press <SET>, the previous frame is displayed. If you hold down <SET>, it will rewind the movie.
 <b>Next frame</b>	Each time you press <SET>, the movie will play frame-by-frame. If you hold down <SET>, it will fast forward the movie.
 <b>Last frame</b>	Displays the movie's last frame.
 <b>Background music*</b>	Plays back a movie with the selected background music (p.297).
 <b>Edit</b>	Displays the editing screen (p.292).
	Playback position
<b>mm' ss"</b>	Playback time (minutes:seconds)
 <b>Volume</b>	Turn the <◀🔊▶> dial to adjust the volume of the built-in speaker (p.290).
	Press the <MENU> button to return to the single-image display.

\* When background music is set, the movie sound will not be played back.



- With a fully-charged Battery Pack LP-E17, the continuous playback time at room temperature (23°C / 73°F) is approx. 2 hr. 20 min.
- If you connect the camera to a TV set to play back a movie (p.298, 301), adjust the sound volume with the TV set. (Turning the <◀🔊▶> dial will not change the sound volume.)
- If you take a still photo while you are shooting the movie, the still photo will be displayed for approx. 1 sec. during the movie playback.

## Playback with the Touch Screen

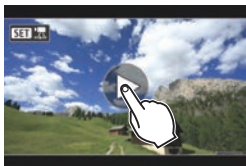

Tap [▶] on the center of the screen.

- ▶ The movie will start playing back.
- To display the movie playback panel, tap <SET [SET] > on the upper left of the screen.
- To pause the movie while it is playing back, tap on the screen. The movie playback panel will also appear.

## ✂ Editing a Movie's First and Last Scenes

You can edit out the first and last scenes of a movie in approx. 1-sec. increments.



1 On the movie playback screen, select [✂].

- ▶ The movie editing panel will be displayed at the bottom of the screen.



2 Specify the part to be edited out.

- Select either [✂] (Cut beginning) or [✂] (Cut end), then press <SET>.
- Press the <◀> <▶> keys to see the previous or next frames. Holding down the key will fast forward or fast rewind the frames.
- After deciding which part to edit out, press <SET>. The portion highlighted in gray on the top of the screen will remain.





### 3 Check the edited movie.

- Select [▶] and press <SET> to play back the edited movie.
- To change the editing, go back to step 2.
- To cancel the editing, press the <MENU> button, then select [OK] on the confirmation dialog.



### 4 Save the edited movie.

- Select [💾], then press <SET>.
- ▶ The save screen will appear.
- To save it as a new movie, select [New file]. To save it and overwrite the original movie file, select [Overwrite], then press <SET>.
- On the confirmation dialog, select [OK], then press <SET> to save the edited movie and return to the movie playback screen.



- Since the editing is performed in approx. 1-sec. increments (position indicated by [✂] on the top of the screen), the actual position where the movie is edited may differ from the position you specified.
- If the card does not have enough free space, [New file] will not be available.
- When the battery level is low, movie editing is not possible. Use a fully-charged battery.

## MENU Slide Show (Auto Playback)

You can play back the images on the card as an automatic slide show.

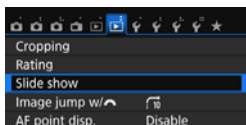

Number of images to be played back

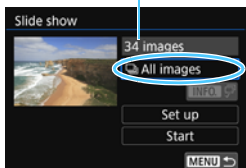

### 1 Select [Slide show].

- Under the [▶] 2 tab, select [Slide show], then press <SET>.

### 2 Select the images to be played back.

- Press the <▲> <▼> keys to select the desired option, then press <SET>.

#### All images/Movies/Stills

- Press the <▲> <▼> keys to select one of the following: [📁 All images] [🎞 Movies] [📷 Stills]. Then press <SET>.

#### Date/Folder/Rating

- Press the <▲> <▼> keys to select one of the following: [📅 Date] [📁 Folder] [★ Rating].
- When <INFO. [✓]> is highlighted, press the <INFO.> button.
- Press the <▲> <▼> keys to select an option, then press <SET>.

[Date]

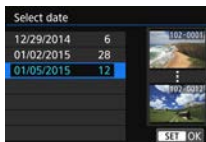

[Folder]

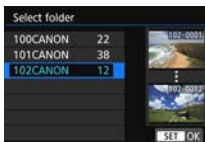

[Rating]



Item	Playback Description
<b>All images</b>	All the still photos and movies on the card will be played back.
<b>Date</b>	Still photos and movies taken on the selected shooting date will be played back.
<b>Folder</b>	Still photos and movies in the selected folder will be played back.
<b>Movies</b>	Only the movies on the card will be played back.
<b>Stills</b>	Only the still photos on the card will be played back.
<b>Rating</b>	Only the still photos and movies with the selected rating will be played back.

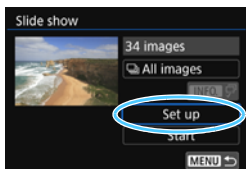

### 3 Configure [Set up] as desired.

- Press the <▲> <▼> keys to select [Set up], then press <SET>.
- Set the [Display time], [Repeat] (repeated playback), [Transition effect] (effect when changing images), and [Background music] for the still photos.
- The background music selection procedure is explained on page 297.
- After selecting the settings, press the <MENU> button.

[Display time]

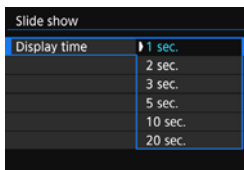

[Repeat]

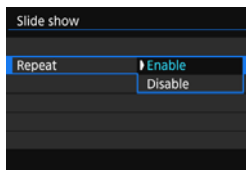

[Transition effect]

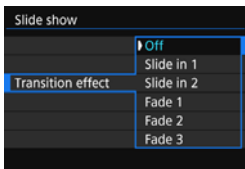

[Background music]

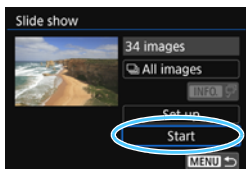
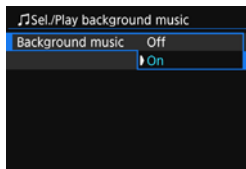

4 Start the slide show.

- Press the <▲><▼> keys to select [Start], then press <SET>.
- ▶ After [Loading image...] is displayed, the slide show will start.

5 Exit the slide show.

- To exit the slide show and return to the setting screen, press the <MENU> button.

- To pause the slide show, press <SET>. During pause, [||] will be displayed on the upper left of the image. Press <SET> again to resume the slide show. You can also pause the slide show by tapping on the screen.
- During auto playback, you can press the <INFO.> button to change the still photo display format (p.97).
- During movie playback, you can adjust the sound volume by turning the <SOUND> dial.
- During auto playback or pause, you can press the <◀> <▶> keys to view another image.
- During auto playback, auto power off will not take effect.
- The display time may vary depending on the image.
- To view the slide show on a TV set, see page 298.



## Selecting the Background Music

After you use EOS Utility (EOS software) to copy background music to the card, you can play background music together with the slide show.



### 1 Select [Background music].

- Set [Background music] to [On], then press <SET>.
- If the card has no background music, you cannot perform step 2.

### 2 Select the background music.

- Press the <▲> <▼> keys to select the desired background music, then press <SET>. You can also select multiple background music tracks.

### 3 Play the background music.

- To listen to a sample of the background music, press the <INFO.> button.
- Press the <▲> <▼> keys to play another background music track. To stop listening to the background music, press the <INFO.> button again.
- Adjust the sound volume by turning the <☀> dial.
- To delete a background music track, press the <▲> <▼> keys and select the track, then press the <🗑> button.



At the time of purchase, the camera does not have background music. The procedure to copy background music to a card is explained in the EOS Utility Instruction Manual (p.406).

# Viewing Images on a TV Set

You can view still photos and movies on a TV set.

- If the video system format does not match the TV set's, movies will not be displayed properly. In such a case, switch to the proper video system format with [**3**: Video system].
- If [**1**: Wi-Fi/NFC] is set to [Enable], the camera cannot be connected to a TV set. Set [Wi-Fi/NFC] to [Disable], then reconnect the camera to the TV set with an HDMI cable or stereo AV cable.

## Viewing on High-Definition (HD) TV Sets (Connected with HDMI)

HDMI Cable HTC-100 (sold separately) is required.

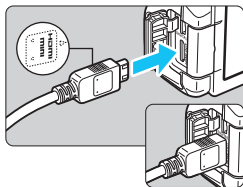

### 1 Connect the HDMI cable to the camera.

- With the plug's <▲ HDMI MINI> logo facing the front of the camera, insert it into the <HDMI OUT> terminal.

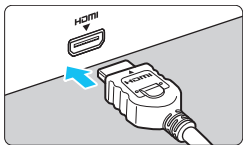

### 2 Connect the HDMI cable to the TV set.

- Connect the HDMI cable to the TV set's HDMI IN port.

### 3 Turn on the TV set and switch the TV set's video input to select the connected port.

### 4 Set the camera's power switch to <ON>.

- Adjust movie sound volume with the TV set. The sound volume cannot be adjusted with the camera.
- Before connecting or disconnecting the cable between the camera and TV set, turn off the camera and TV set.
- Depending on the TV set, part of the image displayed may be cut off.

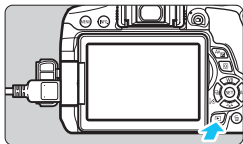

## 5 Press the <▶> button.

- ▶ The image will appear on the TV screen. (Nothing will be displayed on the camera's LCD monitor.)
- The images will automatically be displayed at the optimum resolution of the TV set.
- By pressing the <INFO.> button, you can change the display format.
- To play back movies, see page 290.



The images cannot be output at the same time from both the <HDMI OUT> and <A/V OUT> terminals.



- Do not connect any other device's output to the camera's <HDMI OUT> terminal. Doing so may cause a malfunction.
- Certain TV sets may not be able to display the captured movies. In such a case, use the stereo AV cable AVC-DC400ST (sold separately) to connect to the TV set.

## Using HDMI CEC TV Sets

If the TV set connected to the camera with an HDMI cable is compatible with HDMI CEC\*, you can use the TV set's remote control for playback operations.

\* An HDMI-standard function enabling HDMI devices to control each other so that you can control them with one remote control unit.

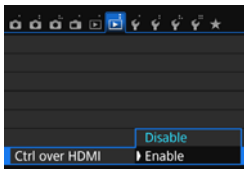

## 1 Set [Ctrl over HDMI] to [Enable].

- Under the [▶ 2] tab, select [Ctrl over HDMI], then press <SET>.
- Select [Enable], then press <SET>.

## 2 Connect the camera to a TV set.

- Use an HDMI cable to connect the camera to the TV set.
- ▶ The TV set's input will switch automatically to the HDMI port connected to the camera. If it does not switch automatically, use the TV set's remote control to select the HDMI IN port the cable is connected to.

## 3 Press the camera's <▶> button.

- ▶ An image will appear on the TV screen and you can use the TV set's remote control to play back images.

## 4 Select an image.

- Point the remote control toward the TV set and press the ←/→ button to select an image.

## Still photo playback menu 5 Press the remote control's Enter button.



### Movie playback menu



- ↶ : Return
- ☐☐☐ : 9-image index
- 🎬 : Play movie
- 👉 : Slide show
- INFO. : Display shooting info
- 🔄 : Rotate

- ▶ The menu appears and you can perform the playback operations shown on the left.
- Press the ←/→ button to select the desired option, then press the Enter button. For a slide show, press the remote control's ↑/↓ button to select an option, then press the Enter button.
- If you select [**Return**] and press the Enter button, the menu will disappear and you can use the ←/→ button to select an image.

- Some TV sets require you to first enable the HDMI CEC connection. For details, refer to the TV set's instruction manual.
- Certain TV sets, even those compatible with HDMI CEC, may not operate properly. In such a case, set [**▶2: Ctrl over HDMI**] to [**Disable**], and use the camera to control the playback operation.

## Viewing on Non-HD TV Sets (Connected with AV Cable)

Stereo AV Cable AVC-DC400ST (sold separately) is required.

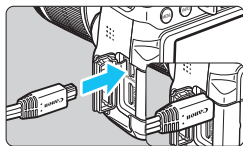

### 1 Connect the AV cable to the camera.

- With the plug's <Canon> logo facing the back of the camera, insert it into the <A/V OUT> terminal.

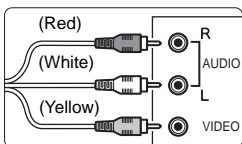

### 2 Connect the AV cable to the TV set.

- Connect the AV cable to the TV set's video IN terminal and audio IN terminals.

### 3 Turn on the TV set and switch the TV's video input to select the connected port.

### 4 Set the camera's power switch to <ON>.

### 5 Press the <▶> button.

- ▶ The image will appear on the TV screen. (Nothing will be displayed on the camera's LCD monitor.)
- To play back movies, see page 290.

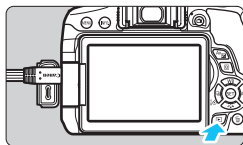

Do not use any AV cable other than the Stereo AV cable AVC-DC400ST (sold separately). Movies may not be displayed if you use a different cable.

## Protecting Images

You can set protections to prevent the precious images from being erased accidentally.

### **MENU** Protecting a Single Image

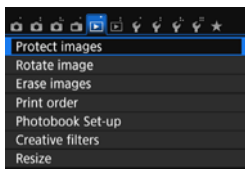

#### 1 Select [Protect images].

- Under the [ 1] tab, select [Protect images], then press <SET>.

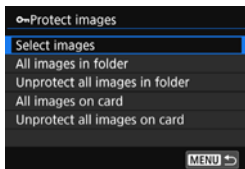

#### 2 Select [Select images].

- Select [Select images], then press <SET>.
- ▶ An image will be displayed.

Image protect icon



#### 3 Protect the image.

- Press the <◀> <▶> keys to select the image to be protected, then press <SET>.
- ▶ The image will be protected, and the <Omni> icon will appear at the top of the screen.
- To cancel the image protection, press <SET> again. The <Omni> icon will disappear.
- To protect another image, repeat step 3.
- To return to the menu, press the <MENU> button.

## **MENU** Protecting All Images in a Folder or on a Card

You can protect all the images in a folder or on a card at once.

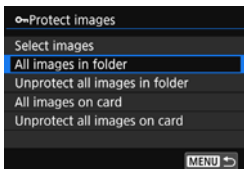

When you select **[All images in folder]** or **[All images on card]** in **[▶ 1: Protect images]**, all the images in the folder or on the card will be protected. To cancel the image protection, select **[Unprotect all images in folder]** or **[Unprotect all images on card]**.

**!** If you format the card (p.59), the protected images will also be erased.



- Movies can also be protected.
- Once an image is protected, it cannot be erased by the camera's erase function. To erase a protected image, you must first cancel the protection.
- If you erase all the images (p.305), only the protected images will remain. This is convenient when you want to erase unnecessary images all at once.

## Erasing Images

You can either select and erase unnecessary images one by one or erase them in one batch. Protected images (p.302) will not be erased.

- 1 **Once an image is erased, it cannot be recovered. Make sure you no longer need the image before erasing it. To prevent important images from being erased accidentally, protect them. Erasing a RAW+JPEG image will erase both the RAW and JPEG images.**

### Erasing a Single Image



1 Play back the image to be erased.

2 Press the  button.

- ▶ The Erase menu will appear.

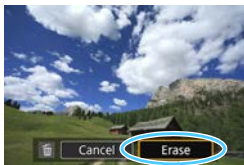

3 Erase the image.



- Select [Erase], then press . The image displayed will be erased.

### **MENU** Checkmarking Images to Be Erased in a Batch

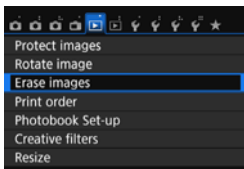
By appending checkmarks  to the images to be erased, you can erase multiple images at once.



1 Select [Erase images].

- Under the [ 1] tab, select [Erase images], then press .



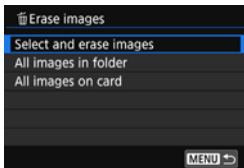

## 2 Select [Select and erase images].

- Select [Select and erase images], then press <SET>.
- ▶ An image will be displayed.



## 3 Select the images to be erased.

- Press the <◀> <▶> keys to select the image to be erased, then press <SET>.
- ▶ A checkmark <✓> will be displayed on the upper left of the screen.
- By pressing the <☒·Q> button, you can select images from a three-image display. To return to the single-image display, press the <Q> button.
- To select other images to be erased, repeat step 3.

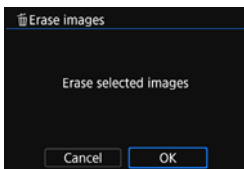

## 4 Erase the image.

- Press the <☒> button.
- Select [OK], then press <SET>.
- ▶ The selected images will be erased.

### **MENU** Erasing All Images in a Folder or on a Card

You can erase all the images in a folder or on a card at once. When [▶ 1: Erase images] is set to [All images in folder] or [All images on card], all the images in the folder or on the card will be erased.

 To erase all images including protected images, format the card (p.59).

# INFO.: Shooting Information Display

The information displayed varies depending on the shooting mode and settings.

## Sample Information for Still Photos

### ● Basic information display

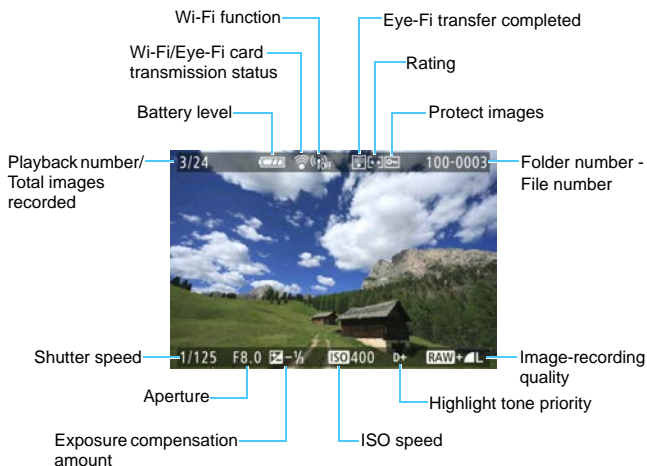

## ● Shooting information display

### ● Detailed information

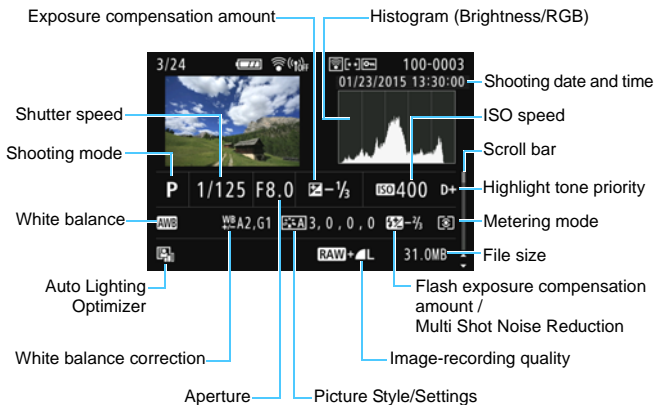

- \* When you shoot in [RAW + ] image quality, the RAW file size will be displayed.
- \* During flash photography without flash exposure compensation, < > will be displayed.
- \* < > will be displayed for images shot with Multi Shot Noise Reduction.
- \* For still photos taken during movie shooting, < > will be displayed.
- \* If a Creative filter or resizing is applied to the image and then saved, < > will be displayed.
- \* For cropped images, < > and < > will be displayed.

If the image was taken by another camera, certain shooting information may not be displayed.

• **Lens/Histogram information**

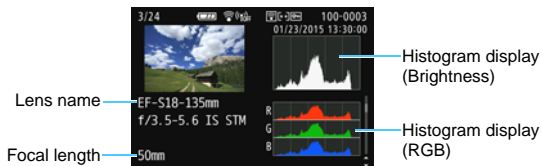

• **White balance information**



• **Picture Style information**

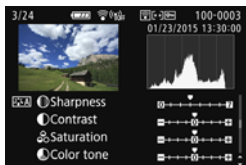

• **Color space / Noise reduction information**

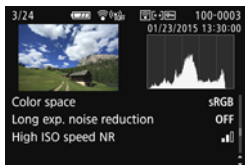

• **Lens aberration correction information**



• **GPS information**

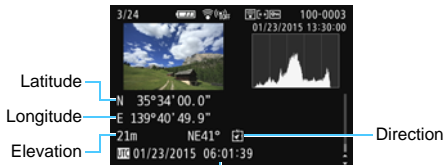



UTC (Coordinated Universal Time)

 If GPS information was not recorded for the image, the GPS information screen will not be displayed.

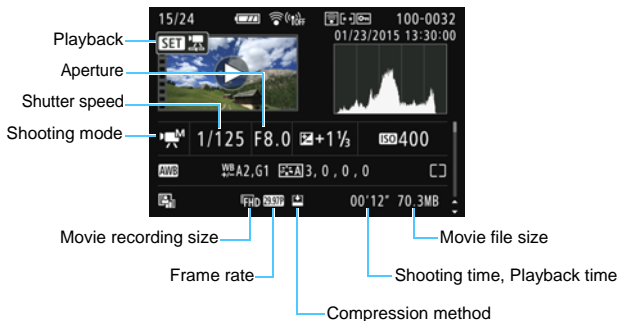
## Sample Movie Information Display



- \* If manual exposure is used, the shutter speed, aperture, and ISO speed (when set manually) will be displayed.
- \* The  icon will be displayed for video snapshots.
- \* The  icon will be displayed for Miniature effect movies.

### ● AF Point Display

When [ 2: AF point disp.] is set to [Enable], the AF point that has achieved focus will be displayed in red. If automatic AF point selection is set, multiple AF points may be displayed.

## ● Highlight Alert

When the shooting information is displayed, any overexposed areas of the image will blink. To obtain more image detail in the overexposed, blinking areas, set the exposure compensation to a negative amount and shoot again.

## ● Histogram

The brightness histogram shows the exposure level distribution and overall brightness. The RGB histogram is for checking the color saturation and gradation. The display can be switched with [▶] 2: **Histogram disp**].

### [Brightness] Display

This histogram is a graph showing the distribution of the image's brightness level. The horizontal axis indicates the brightness level (darker on the left and brighter on the right), while the vertical axis indicates how many pixels exist for each brightness level. The more pixels there are toward the left, the darker the image. The more pixels there are toward the right, the brighter the image. If there are too many pixels on the left, the shadow detail will be lost. If there are too many pixels on the right, the highlight detail will be lost. The gradation in-between will be reproduced. By checking the image and its brightness histogram, you can see the exposure level inclination and the overall gradation.

### Sample Histograms



Dark image



Normal brightness



Bright image

### [RGB] Display

This histogram is a graph showing the distribution of each primary color's brightness level in the image (RGB or red, green, and blue). The horizontal axis indicates the color's brightness level (darker on the left and brighter on the right), while the vertical axis indicates how many pixels exist for each color brightness level. The more pixels there are toward the left, the darker and less prominent the color. The more pixels there are toward the right, the brighter and denser the color. If there are too many pixels on the left, the respective color information will be lacking. If there are too many pixels on the right, the color will be too saturated with no gradation. By checking the image's RGB histogram, you can see the color's saturation and gradation condition, as well as white balance inclination.

# 11

## Post-Processing Images

After taking a picture, you can apply a Creative filter, resize the JPEG image (reduce the number of pixels), or crop the image.

- The camera may not be able to process images taken with another camera.
- Post-processing images as described in this chapter cannot be performed when the camera is connected to a computer via the <DIGITAL> terminal.

# Applying Creative Filters

You can apply the following Creative filters to an image and save it as a new image: Grainy B/W, Soft focus, Fish-eye effect, Art bold effect, Water painting effect, Toy camera effect, and Miniature effect.

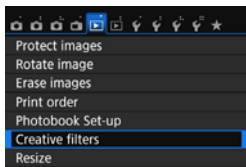

## 1 Select [Creative filters].

- Under the [▶1] tab, select [Creative filters], then press <SET>.
- ▶ An image will be displayed.



## 2 Select an image.

- Select the image you want to apply a filter to.
- By pressing the <[Q]> button, you can switch to the index display and select an image.



## 3 Select a filter.

- When you press <SET>, the types of Creative filters will be displayed (p.313).
- Press the <◀> <▶> keys to select a filter, then press <SET>.
- ▶ The image will be displayed with the effects of the filter applied.



## 4 Adjust the filter effect.

- Press the <◀> <▶> keys to adjust the filter effect, then press <SET>.
- For the Miniature effect, press the <▲> <▼> keys and select the image area (within the white frame) where you want the image to look sharp, then press <SET>.



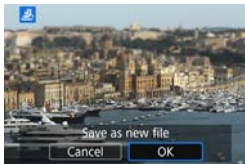

## 5 Save the image.

- Select [OK] to save the image.
- Check the destination folder and image file number, then select [OK].
- To apply a filter to another image, repeat steps 2 to 5.
- To return to the menu, press the <MENU> button.



- When shooting **RAW** + **L** or **RAW** image, the filter effect will be applied to the **RAW** image and the image will be saved as a JPEG image.
- If an aspect ratio was set for a **RAW** image and the filter effect is applied to it, the image will be saved in the aspect ratio that is set.
- Dust Delete Data (p.272) will not be appended to images with Fish-eye effect applied.

## Creative Filter Characteristics

- **Grainy B/W**  
Creates a grainy black-and-white photo. You can change the black-and-white effect by adjusting the contrast.
- **Soft focus**  
Gives the image a soft look. You can change the degree of softness by adjusting the blur.

- **Fish-eye effect**

Gives the effect of a fish-eye lens. The image will have a barrel-type distortion.

Depending on the level of this filter effect, the area trimmed along the periphery of the image changes. Also, since this filter effect will magnify the image center, the apparent resolution at the center may degrade depending on the number of recorded pixels. Set the filter effect in step 4 while checking the resulting image.

- **Art bold effect**

Makes the photo look like an oil painting and the subject look more three-dimensional. You can adjust the contrast and saturation. Note that the sky, white walls, and similar subjects may not be rendered with a smooth gradation and may look irregular or have significant noise.

- **Water painting effect**

Makes the photo look like a watercolor painting with soft colors. You can control the color density by adjusting the filter effect. Note that night scenes or dark scenes may not be rendered with a smooth gradation and may look irregular or have significant noise.

- **Toy camera effect**

Darkens the photo's corners and applies a color tone that makes it look as if it was shot by a toy camera. You can change the color cast by adjusting the color tone.

- **Miniature effect**

Creates a diorama effect. You can change where the image looks sharp. In step 4, if you press the <INFO.> button (or tap on [INFO.] at the screen's bottom), you can switch between the white frame's vertical and horizontal orientations.

## Resizing JPEG Images

You can resize a JPEG image to make the pixel count lower and save it as a new image. Resizing an image is possible only with JPEG L/M/S1/S2 images. JPEG S3 and RAW images cannot be resized.

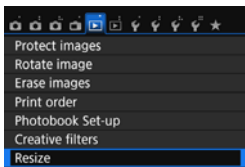



### 1 Select [Resize].

- Under the [ 1] tab, select [Resize], then press <SET>.
- ▶ An image will be displayed.



### 2 Select an image.

- Select the image you want to resize.
- By pressing the <- > button, you can switch to the index display and select an image.



Target sizes

### 3 Select the desired image size.

- Press <SET> to display the image sizes.
- Press the <◀> <▶> keys to select the desired image size, then press <SET>.



### 4 Save the image.

- Select [OK] to save the resized image.
- Check the destination folder and image file number, then select [OK].
- To resize another image, repeat steps 2 to 4.
- To return to the menu, press the <MENU> button.

## Resize Options by Original Image Size

Original Image Size	Available Resize Settings			
	M	S1	S2	S3
L	<input type="radio"/>	<input type="radio"/>	<input type="radio"/>	<input type="radio"/>
M		<input type="radio"/>	<input type="radio"/>	<input type="radio"/>
S1			<input type="radio"/>	<input type="radio"/>
S2				<input type="radio"/>

## Image Sizes

The image sizes displayed in step 3 on the preceding page, such as [\*\*\*M \*\*\*x\*\*\*], have a 3:2 aspect ratio. The image sizes by aspect ratios are shown in the table below.

The asterisked image-recording quality figures do not exactly match the aspect ratio. The image will be cropped slightly.

Image Quality	Aspect Ratio and Pixel Count (Approx.)			
	3:2	4:3	16:9	1:1
M	3984x2656 (10.6 megapixels)	3552x2664 (9.5 megapixels)	3984x2240* (8.9 megapixels)	2656x2656 (7.1 megapixels)
S1	2976x1984 (5.9 megapixels)	2656x1992 (5.3 megapixels)	2976x1680* (5.0 megapixels)	1984x1984 (3.9 megapixels)
S2	1920x1280 (2.5 megapixels)	1696x1280* (2.2 megapixels)	1920x1080 (2.1 megapixels)	1280x1280 (1.6 megapixels)
S3	720x480 (0.35 megapixels)	640x480 (0.31 megapixels)	720x408* (0.29 megapixels)	480x480 (0.23 megapixels)

## 🔍 Cropping JPEG Images

You can crop the image as desired and save it as a new image. **JPEG S3 and RAW images cannot be cropped.** The **RAW+L** image's JPEG image can be cropped.

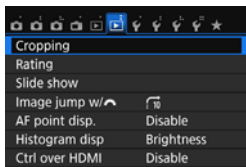

### 1 Select [Cropping].

- Under the [**2**] tab, select [**Cropping**], then press <SET>.
- ▶ An image will be displayed.



### 2 Select an image.

- Select the image you want to crop.
- By pressing the <[crop icon]-Q> button, you can switch to the index display and select an image.



### 3 Set the cropping frame size, aspect ratio, position, and orientation.

- Press <SET> to display the cropping frame.
- ▶ The image area within the cropping frame will be cropped.

### Changing the Cropping Frame Size

- Press the <Q> or <[crop icon]-Q> button.
- ▶ The cropping frame size will change. The smaller the cropping frame, the larger the image magnification will be.

### Changing the Cropping Frame Aspect Ratio

- Turn the <[gear icon]> dial.
- ▶ Cropping frame aspect ratio will change to [3:2], [16:9], [4:3], or [1:1].

### Moving the Cropping Frame

- Press the <▲> <▼> or <◀> <▶> keys.
- ▶ The cropping frame will move up, down, left, or right.
- You can also touch the cropping frame and drag it to the desired position.

### Rotating the Cropping Frame Orientation

- Press the <INFO.> button.
- ▶ The cropping frame will switch between the vertical and horizontal orientations. This enables you to create a vertical image from a horizontal one, and vice versa.



### 4 Display the cropped image in the full view.

- Press the <[Q]> button.
- ▶ You can see the cropped image.
- To return to the original display, press the <[Q]> button again.

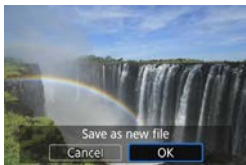

### 5 Save the image.

- Press <[SET]> and select [OK] to save the cropped image.
- Check the destination folder and image file number, then select [OK].
- To crop another image, repeat steps 2 to 5.
- To return to the menu, press the <[MENU]> button.

- You cannot crop an image that has already been cropped.
- You cannot apply a Creative filter or resizing to a cropped image.

# 12

## Printing Images

- **Printing** (p.320)  
You can connect the camera directly to a printer and print out the images on the card. The camera is compliant with “PictBridge”, which is the standard for direct printing. You can also use a wireless LAN to send images to a PictBridge (Wireless LAN) printer and print them. For details, refer to the Wi-Fi/NFC Function Instruction Manual.
- **Digital Print Order Format (DPOF)** (p.329)  
DPOF (Digital Print Order Format) enables you to print images recorded on the card according to your printing instructions such as the image selection, quantity to print, etc. You can print multiple images in one batch or give the print order to a photofinisher.
- **Specifying Images for a Photobook** (p.333)  
You can specify images on the card for printing in a photobook.

## Preparing to Print

The direct printing procedure can be performed entirely with the camera while looking at the setting screens on camera's LCD monitor.

### Connecting the Camera to a Printer

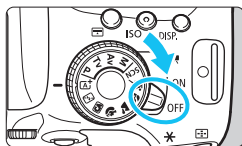

- 1 Set the camera's power switch to <OFF>.

- 2 Set up the printer.

- For details, refer to the printer's instruction manual.

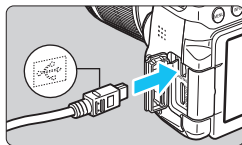

- 3 Connect the camera to the printer.

- Use the interface cable provided with the camera.
- Connect the cable to the camera's <DIGITAL> terminal with the cable plug's <↔> icon facing the front of the camera.
- To connect to the printer, refer to the printer's instruction manual.

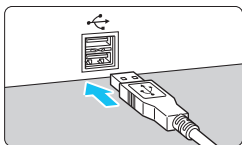

- 4 Turn on the printer.

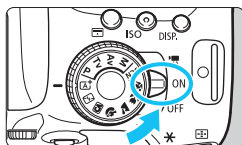

- 5 Set the camera's power switch to <ON>.

- ▶ Some printers may make a beeping sound.





## 6 Play back the image.

- Press the <▶> button.
- ▶ The image will appear with the <🖨️> icon on the upper left of the screen to indicate that the camera is connected to a printer.



- Before using the printer, make sure it has a PictBridge connection port.
- Movies cannot be printed.
- The camera cannot be used with printers compatible only with CP Direct or Bubble Jet Direct.
- Do not use any interface cable other than the one provided.
- If there is a long beeping sound in step 5, it indicates a problem with the printer. Resolve the problem displayed in the error message (p.328).
- If any of the following shooting modes or functions is set, the camera cannot be connected to a printer. Cancel all the relevant settings, then reconnect the camera to the printer with an interface cable.
  - <▶> or <🖨️> in <SCN> mode
  - Multi Shot Noise Reduction
  - [🔊1: Wi-Fi/NFC] set to [Enable]



- You can also print RAW images taken with this camera.
- When you use a battery to power the camera, make sure it is fully charged. With a fully-charged battery pack, you can print for approx. 2 hr.
- Before disconnecting the cable, first turn off the camera and printer. Hold the plug (not the cord) to pull out the cable.
- For direct printing, using AC Adapter Kit ACK-E18 (sold separately) to power the camera is recommended.

# ☞ Printing

The screen display and setting options will differ depending on the printer. Some settings may not be available. For details, refer to the printer's instruction manual.

Printer-connected icon



## 1 Select the image to be printed.

- Check that the <☞> icon is displayed on the upper left of the LCD monitor.
- Press the <◀> <▶> keys to select the image to be printed.

## 2 Press <SET>.

- ▶ The print setting screen will appear.

### Print setting screen

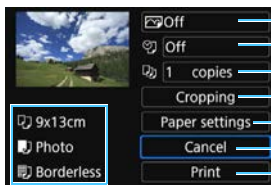

Off — Sets the printing effects (p.324).

Off — Sets the date or file number imprinting to on or off.

1 copies — Sets the quantity to be printed.

Cropping — Sets the print area (p.327).

Paper settings — Sets the paper size, type, and layout.

Cancel — Returns to the screen in step 1.

Print — Starts the printing.

The paper size, type, and layout you have set are displayed.

\* Depending on the printer, certain settings such as the date and file number imprinting and cropping may not be selectable.

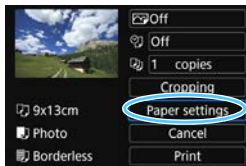

## 3 Select [Paper settings].

- Select [Paper settings], then press <SET>.
- ▶ The paper settings screen will appear.

## Setting the Paper Size

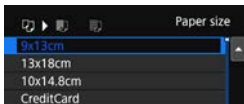

- Select the size of the paper loaded in the printer, then press **<SET>**.
- ▶ The paper type screen will appear.

## Setting the Paper Type

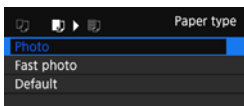

- Select the type of the paper loaded in the printer, then press **<SET>**.
- ▶ The page layout screen will appear.

## Setting the Page Layout

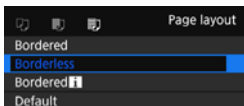

- Select the page layout, then press **<SET>**.
- ▶ The print setting screen will reappear.

<b>Bordered</b>	Prints with white borders along the edges.
<b>Borderless</b>	Prints with no borders. If your printer cannot print borderless prints, the print will have borders.
<b>Bordered </b>	Imprints the shooting information*1 on the border on 9x13 cm or larger prints.
<b>xx-up</b>	Option to print 2, 4, 8, 9, 16, or 20 images on one sheet.
<b>20-up </b>	Prints 20 or 35 images as thumbnails on A4 or Letter size paper*2. • Imprints the shooting information*1 with <b>[20-up </b> ].
<b>35-up </b>	
<b>Default</b>	The page layout varies depending on the printer model or its settings.

\*1: From the Exif data, the camera name, lens name, shooting mode, shutter speed, aperture, exposure compensation amount, ISO speed, white balance, etc., are imprinted.

\*2: After ordering the prints with "Digital Print Order Format (DPOF)" (p.329), printing by following "Direct Printing of Print-Ordered Images" (p.332) is recommended.

If the image's aspect ratio is different from the printing paper's aspect ratio, the image may be cropped significantly when you print it as a borderless print. If the image is cropped, the print may look grainier due to the fewer number of pixels.

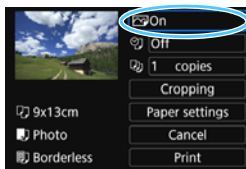

## 4 Set the printing effects (image optimization).

- Set them if necessary. If you do not need to set any printing effects, go to step 5.
- **Contents displayed on the screen vary depending on the printer.**
- Select the option, then press <SET>.
- Select the desired printing effect, then press <SET>.
- If the <INFO. [INFO icon]> icon is displayed brightly, you can also adjust the printing effects (p.326).

Printing Effect	Description
On	Prints with the printer's standard colors. The image's Exif data is used to make automatic corrections.
Off	No automatic correction is applied.
Vivid	Prints with higher saturation to produce more vivid blues and greens.
NR	Image noise is reduced before printing.
<b>B/W B/W</b>	Prints in black-and-white with true blacks.
<b>B/W Cool tone</b>	Prints in black-and-white with cool, bluish blacks.
<b>B/W Warm tone</b>	Prints in black-and-white with warm, yellowish blacks.
Natural	Prints the image in the actual colors and contrast. No automatic color adjustments are applied.
Natural M	Printing characteristics are the same as the "Natural" setting. However, this setting enables finer printing adjustments than with "Natural".
Default	Printing differs depending on the printer. For details, refer to the printer's instruction manual.

\* When you change the printing effects, changes are reflected in the image displayed on the upper left of the screen. Note that the printed image may look slightly different from the displayed image, which is only an approximation. This also applies to [Brightness] and [Adjust levels] on page 326.

If you imprint shooting information on an image shot at an expanded ISO speed (H), the correct ISO speed may not be imprinted.

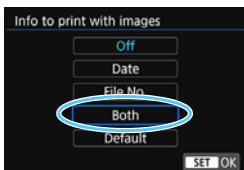

## 5 Set the date and file number imprinting.

- Set them if necessary.
- Select <📅>, then press <SET>.
- Set the print settings as desired, then press <SET>.



## 6 Set the number of copies.

- Set it if necessary.
- Select <📄>, then press <SET>.
- Set the number of copies, then press <SET>.

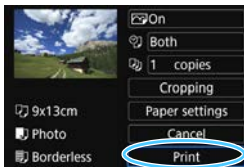

## 7 Start printing.

- Select [Print], then press <SET>.



- The [Default] setting for printing effects and other options are the printer's own default settings as set by the printer's manufacturer. Refer to the printer's instruction manual to find out what the [Default] settings are.
- Depending on the image's file size and image-recording quality, it may take some time for the printing to start after you select [Print].
- If image tilt correction (p.327) is applied, it may take longer to print the image.
- To stop the printing, press <SET> while [Stop] is displayed, then select [OK].
- If you execute [F4: Clear all camera settings] (p.267), all the settings will revert to their defaults.

## Adjusting Printing Effects

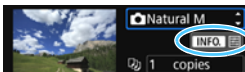

In step 4 on page 324, select the printing effect. When the <INFO. [INFO] > icon is displayed brightly, you can press the <INFO.> button. You can then adjust the printing effects. What can be adjusted or what is displayed will depend on the selection made in step 4.

### Brightness

The image brightness can be adjusted.

### Adjust levels

When you select [Manual], you can change the histogram's distribution and adjust the image's brightness and contrast.

With the Adjust levels screen displayed, press the <INFO.> button to change the position of the <↑>. Press the <◀> <▶> keys to freely adjust the shadow level (0-127) or highlight level (128-255).



### Brightener

Effective in backlit conditions where the subject's face looks dark. When [On] is set, the face will be brightened for printing.

### Red-eye corr.

Effective in flash images where the subject has red eyes. When [On] is set, the red eye will be corrected for printing.

- The [Brightener] and [Red-eye corr.] effects will not be reflected on the screen.
- When [Detail set.] is selected, you can adjust the [Contrast], [Saturation], [Color tone], and [Color balance]. To adjust the [Color balance], press the <▲> <▼> or <◀> <▶> keys. B is for blue, A for amber, M for magenta, G for green. The image's color balance will be adjusted towards the color in the direction of move.
- If you select [Clear all], all the printing effect settings will be reverted to their defaults.

## Cropping the Image

Tilt correction



You can crop the image and print only an enlarged version of the cropped portion, as if the image is recomposed.

**Set the cropping right before printing.**

If you change the print settings after setting the cropping, you may have to set the cropping again before printing.

- 1 On the print setting screen, select [Cropping].
- 2 Set the cropping frame size, position, and aspect ratio.
  - The image area within the cropping frame will be printed. The cropping frame's aspect ratio can be changed with [Paper settings].

### Changing the Cropping Frame Size

Press the <Q> or <[ ]-Q> button to change the cropping frame size. The smaller the cropping frame, the larger the image magnification will be for printing.

### Moving the Cropping Frame

Press the <←> cross keys to move the frame over the image vertically or horizontally. Move the cropping frame until it covers the desired image area.

### Switching the Orientations of the Cropping Frame

Pressing the <INFO.> button will toggle the cropping frame between the vertical and horizontal orientations. This enables you to create a vertically oriented print from a horizontal image.

### Image Tilt Correction

By turning the <[ ]> dial, you can adjust the image tilt angle up to ±10 degrees in 0.5-degree increments. When you adjust the image tilt, the <[ ]> icon on the screen will turn blue.

- 3 Press <[SET]> to exit the cropping.
  - ▶ The print setting screen will reappear.
  - You can check the cropped image area on the upper left of the print setting screen.

- Depending on the printer, the cropped image area may not be printed as you specified.
- The smaller you make the cropping frame, the grainier the picture will look in the print.
- Check the camera's LCD monitor while cropping the image. If you look at the image on a TV screen, the cropping frame may not be displayed accurately.



## Handling Printer Errors

If printing does not resume after you resolve a printer error (no ink, no paper, etc.) and select **[Continue]**, operate the buttons on the printer to resume printing. For details on resuming the printing, refer to the printer's instruction manual.

### Error Messages

If a problem occurs during printing, an error message will appear on the camera's LCD monitor. Press <  > to stop printing. After fixing the problem, resume printing. For details on how to fix a printing problem, refer to the printer's instruction manual.

#### Paper Error

Check whether the paper is properly loaded in the printer.

#### Ink Error

Check the printer's ink level and the waste ink tank.

#### Hardware Error

Check for any printer problems other than paper and ink problems.

#### File Error

The selected image cannot be printed via PictBridge. Images taken with a different camera or images edited with a computer may not be printable.



# Digital Print Order Format (DPOF)

You can set the print type, date imprinting, and file number imprinting. The print settings will be applied to all print-ordered images. (They cannot be set individually for each image.)

## Setting the Printing Options

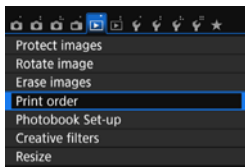

### 1 Select [Print order].

- Under the [▶] 1 tab, select [Print order], then press <SET>.

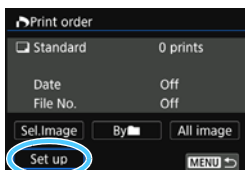

### 2 Select [Set up].

- Select [Set up], then press <SET>.

### 3 Set the option as desired.

- Set the [Print type], [Date], and [File No.].
- Select the option to be set, then press <SET>. Select the desired setting, then press <SET>.

[Print type]

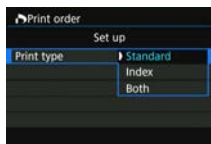

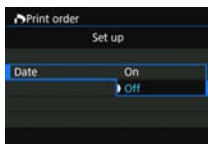

[Date]

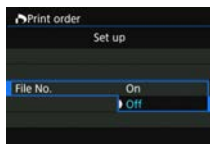

[File No.]



Print type		Standard	Prints one image on one sheet.
		Index	Multiple thumbnail images are printed on one sheet.
		Both	Prints both the standard and index prints.
Date	On	[On] imprints the recorded date on the print.	
	Off		
File number	On	[On] imprints the file number on the print.	
	Off		

## 4 Exit the setting.

- Press the <MENU> button.
- ▶ The print order screen will reappear.
- Next, select [**Sel.Image**], [**By** ], or [**All image**] to order the images to be printed.

- RAW images and movies cannot be print ordered. You can print RAW images with PictBridge (p.320).
- Even if [**Date**] and [**File No.**] are set to [**On**], the date or file number may not be imprinted depending on the print type setting and printer model.
- With [**Index**] prints, the [**Date**] and [**File No.**] cannot both be set to [**On**] at the same time.
- When printing with DPOF, use the card whose print order specifications have been set. It cannot be printed with the specified print order if you just extract images from the card and try to print them.
- Certain DPOF-compatible printers and photofinishers may not be able to print the images as you specified. Refer to the printer's instruction manual before printing, or check with your photofinisher about compatibility when ordering prints.
- Do not insert into the camera a card whose print order was set by a different camera and then try to specify a print order. The print order may be overwritten. Also, the print order may not be possible, depending on the image type.

## Print Ordering

### ● Sel.Image

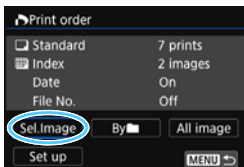

Select and order images one by one. By pressing the  $\langle \text{Sel} \cdot \text{Image} \rangle$  button, you can select images from a three-image display. To return to the single-image display, press the  $\langle \text{Image} \rangle$  button. Press the  $\langle \text{MENU} \rangle$  button to save the print order to the card.

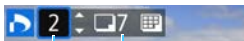

Quantity

Total images selected

### [Standard] [Both]

Press the  $\langle \blacktriangle \rangle$   $\langle \blacktriangledown \rangle$  keys to set the number of copies to be printed for the displayed image.



Checkmark

Index icon

### [Index]

Press  $\langle \text{SET} \rangle$  to add a checkmark to the box  $\langle \checkmark \rangle$ . The image will be included in the index print.

### ● By [Folder]

Select **[Mark all in folder]** and select the folder. A print order for one copy of all the images in the folder will be specified. If you select **[Clear all in folder]** and select the folder, the print order for that folder will all be canceled.

### ● All image

If you select **[Mark all on card]**, one copy of all the images on the card will be set for printing. If you select **[Clear all on card]**, the print order will be cleared for all the images on the card.



- Note that RAW images and movies will not be included in the print order even if you set **[By [Folder]]** or **[All image]**.
- When using a PictBridge printer, print no more than 400 images for one print order. If you specify more than this, all the images may not be printed.

## Direct Printing of Print-Ordered Images

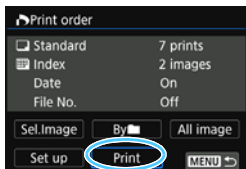

With a PictBridge printer, you can easily print images with DPOF.

### 1 Prepare to print.

- See page 320.

Follow the “Connecting the Camera to a Printer” procedure up to step 5.

### 2 Under the [▶ 1] tab, select [Print order].

### 3 Select [Print].

- [Print] will be displayed only if the camera is connected to a printer and printing is possible.

### 4 Set the [Paper settings] (p.322).

- Set the printing effects (p.324) if necessary.

### 5 Select [OK].

- Before printing, be sure to set the paper size.
- Certain printers cannot imprint the file number.
- If [Bordered] is set, certain printers may imprint the date on the border.
- Depending on the printer, the date may appear faint if it is imprinted on a bright background or on the border.
- Under [Adjust levels], [Manual] cannot be selected.

- If you stopped the printing and want to resume printing the remaining images, select [Resume]. Note that printing will not resume if any of the following occurs.
  - You changed the print order or deleted any of the print ordered images before resuming the printing.
  - When index is set, you changed the paper setting before resuming the printing.
  - The card's remaining capacity was low when you paused the printing.
- If a problem occurs during printing, see page 328.

# Specifying Images for a Photobook

You can specify up to 998 images to be printed in a photobook. When you use EOS Utility (EOS software) to transfer images to a computer, the specified images will be copied to a dedicated folder. This function is useful for ordering photobooks online.

## Specifying One Image at a Time

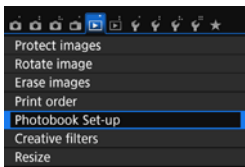

### 1 Select [Photobook Set-up].

- Under the [] tab, select [Photobook Set-up], then press <SET>.

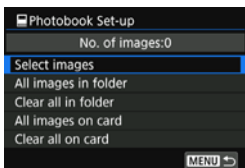

### 2 Select [Select images].

- Select [Select images], then press <SET>.
- An image will be displayed.



### 3 Select the image to be specified.

- Press the <◀> <▶> keys to select the image to be specified, then press <SET>.
- By pressing the <◻·🔍> button, you can select images from a three-image display. To return to the single-image display, press the <🔍> button.
- Repeat this step to select other images. The number of images that have been specified will be displayed on the upper left of the screen.
- To cancel the image specification, press <SET> again.
- To return to the menu, press the <MENU> button.

## Specifying All Images in a Folder or on a Card

You can specify all the images in a folder or on a card at once.

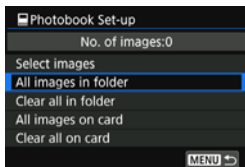

When [▶ 1: **Photobook Set-up**] is set to [**All images in folder**] or [**All images on card**], all the images in the folder or on the card will be specified.

To cancel the image specification, select [**Clear all in folder**] or [**Clear all on card**].

- ⓘ RAW images and movies cannot be specified.
- Do not specify images already specified for a photobook in another camera for another photobook with this camera. The photobook settings may be overwritten.

# 13

## Customizing the Camera

You can customize various camera functions to suit your picture-taking preferences with Custom Functions. Custom Functions can be set and used only in Creative Zone modes.

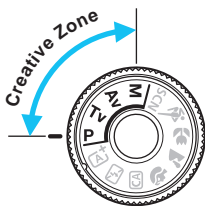

## MENU Setting Custom Functions ☆

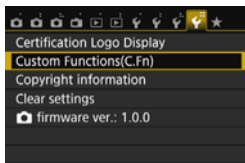

Custom Function number

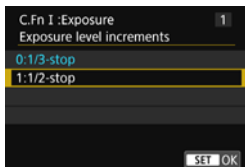
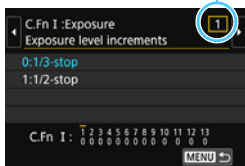

### 1 Select [Custom Functions (C.Fn)].

- Under the [**F4**] tab, select [**Custom Functions (C.Fn)**], then press <SET>.

### 2 Select the Custom Function number.

- Press the <◀> <▶> keys to select the Custom Function number, then press <SET>.

### 3 Change the setting as desired.

- Press the <▲> <▼> keys to select the desired setting (number), then press <SET>.
- Repeat steps 2 and 3 if you want to set other Custom Functions.
- At the bottom of the screen, the current Custom Function settings are indicated below the respective function numbers.

### 4 Exit the setting.

- Press the <MENU> button.
- ▶ The screen for step 1 will reappear.



## Clearing All Custom Functions

Under [**F4: Clear settings**], select [**Clear all Custom Func. (C.Fn)**] to clear all the Custom Function settings (p.267).



## Custom Functions

### C.Fn I: Exposure

			 LV Shooting	 Movie Shooting
1	Exposure level increments	p.338	<input type="radio"/>	<input type="radio"/>
2	ISO expansion		<input type="radio"/>	In <b>M</b>

### C.Fn II: Image

3	Highlight tone priority	p.339	<input type="radio"/>	<input type="radio"/>
---	-------------------------	-------	-----------------------	-----------------------

### C.Fn III: Autofocus/Drive

4	AF-assist beam firing	p.340	<input type="radio"/> *	
5	AF area selection method			
6	Auto AF point selection: Color Tracking	p.341		
7	AF point display during focus			
8	VF display illumination	p.342		
9	Mirror lockup			

\* When an EX-series Speedlite (sold separately) equipped with an LED light is used.

### C.Fn IV: Operation/Others

10	Shutter/AE lock button	p.343	<input type="radio"/>	<input type="radio"/>
11	Assign SET button	p.344	<input type="radio"/> (Except 3)	<input type="radio"/> (Except 2, 3, 6)*
12	LCD display when power ON			
13	Retract lens on power off	p.345	<input type="radio"/>	<input type="radio"/>

\* Settings 1 and 4 do not function during movie shooting.

\* [5: ISO speed] is settable only for manual exposure shooting.



The shaded Custom Functions do not function during Live View (LV) shooting or movie shooting. (Settings are disabled.)

## MENU Custom Function Settings ☆

Custom Functions are organized into four groups based on the function type: C.Fn I: Exposure, C.Fn II: Image, C.Fn III: Autofocus/Drive, C.Fn IV: Operation/Others.

### C.Fn I: Exposure

#### C.Fn-1 Exposure level increments

0: 1/3-stop

1: 1/2-stop

Sets 1/2-stop increments for the shutter speed, aperture, exposure compensation, AEB, flash exposure compensation, etc. This is effective when you prefer to control the exposure in less fine increments than 1/3-stop increments.

 With setting 1, the exposure level will be displayed as shown below.



#### C.Fn-2 ISO expansion

0: Off

1: On

When you set the ISO speed, you can set “H” (equivalent to ISO 25600) for still photos and “H” (equivalent to ISO 12800) for movies. Note that if [C.Fn-3: Highlight tone priority] is set to [1: Enable], “H” cannot be set.

## C.Fn II: Image

### C.Fn-3 Highlight tone priority

0: **Disable**

1: **Enable**

Improves the highlight detail. The dynamic range is expanded from the standard 18% gray to bright highlights. The gradation between the grays and highlights becomes smoother.



- With setting 1, the Auto Lighting Optimizer (p.136) is automatically set to **[Disable]** and the setting cannot be changed.
- With setting 1, noise (grainy image, banding, etc.) may become slightly more noticeable than with setting 0.



With setting 1, the settable range will be ISO 200 - ISO 12800 (up to ISO 6400 for movies).

Also, the <D+> icon will be displayed in the viewfinder and on the LCD monitor to indicate that highlight tone priority is enabled.

## C.Fn III: Autofocus/Drive

### C.Fn-4 AF-assist beam firing

Enables or disables the built-in flash's AF-assist beam or the EOS-dedicated external Speedlite's AF-assist beam.

**0: Enable**

The AF-assist beam will be emitted when necessary.

**1: Disable**

The AF-assist beam will not be emitted. This prevents the AF-assist beam from disturbing others.

**2: Enable external flash only**

If an external Speedlite is attached, it will emit the AF-assist beam when necessary. The camera's built-in flash will not fire the AF-assist beam.

**3: IR AF assist beam only**

When an external Speedlite is attached, only the infrared AF-assist beam will be emitted. Set this when you do not want the camera to fire the AF-assist beam as a burst of small flashes.



With an EX-series Speedlite equipped with an LED light, the LED light will not automatically turn on for AF-assist.

 If the external Speedlite's [AF-assist beam firing] Custom Function is set to [Disable], this function's setting will be overridden and the AF-assist beam will not be emitted.

### C.Fn-5 AF area selection method

You can set the method for changing the AF area selection mode.

**0:  → AF area selection button**

After you press the  or  button, each time you press the  button, the AF area selection mode changes.

**1:  → Main Dial**

After you press the  or  button, turning the  dial changes the AF area selection mode.

- 
  - With setting 1, press the <▲> <▼> or <◀> <▶> keys to move the AF point.
  - When Battery Grip BG-E18 (sold separately) is used and 1 is set, you can change the AF area selection mode by operating the battery grip.

## C.Fn-6 Auto AF point selection: Color Tracking

Use this function to autofocus by recognizing colors equivalent to skin tones. This function works in One-Shot AF mode when the AF area selection mode is set to Zone AF (manual selection of zone) or 19-point AF auto selection.

### 0: One-Shot AF only

In One-Shot AF mode, the camera selects AF points automatically based on AF information and information on colors equivalent to skin tones. This makes focusing on people easier, so you can prioritize composition in shooting.

### 1: Disable

AF points are automatically selected based only on AF information. Generally, the nearest subject will be focused on.



- With setting 0, focusing will take slightly longer than with setting 1.
- Even with setting 0, the expected result may not be obtained depending on the shooting conditions and subject.
- Under light so low that the flash emits the AF-assist beam automatically, AF points are selected automatically based only on AF information. (The AF will not use information on colors equivalent to skin tones.)

## C.Fn-7 AF point display during focus

You can set whether or not to display the AF point(s) in the following cases: 1. when selecting the AF point(s), 2. when the camera is ready to shoot (before AF operation), 3. during AF operation, and 4. when focus is achieved.

### 0: Selected (constant)

The selected AF point(s) is always displayed.

### 1: All (constant)

All 19 AF points are always displayed.

### 2: Selected (pre-AF, focused)

The selected AF point(s) is displayed for 1, 2, and 4.

### 3: Selected (focused)

The selected AF point(s) is displayed for 1 and 4.

### 4: Disable display

For 2, 3, and 4, the selected AF point(s) will not be displayed.



With setting 2 or 3, the AF point will not be displayed even when focus is achieved with AI Servo AF.

## C.Fn-8 VF display illumination

You can set whether or not the AF points in the viewfinder will light up in red when focus is achieved.

### 0: Auto

The AF points automatically light up in red under low light.

### 1: Enable

The AF points light up in red regardless of the ambient light level.

### 2: Disable

The AF points do not light up in red.

 When AI Servo AF is set, there is no illumination in red even when focus is achieved.

-  • When you press the <[AF-ON]> or <[AF-ON]> button, the AF points will be illuminated in red regardless of this setting.
- The aspect ratio lines (p.120), and the grid and flicker detection set with [**42: Viewfinder display**] will also light up in red.

## C.Fn-9 Mirror lockup

### 0: Disable

### 1: Enable

Prevents camera shake due to camera vibrations in the camera caused by the reflex mirror action (mirror shock), when shooting with super telephoto lenses or close-ups (macro photography).

See page 163 for the mirror lockup procedure.

## C.Fn IV: Operation/Others

### C.Fn-10 Shutter/AE lock button

**0: AF/AE lock**

**1: AE lock/AF**

This is convenient when you want to focus and meter separately. Press the <✳> button to autofocus, and press the shutter button halfway to apply AE lock.

**2: AF/AF lock, no AE lock**

During AI Servo AF, you can press the <✳> button to pause the AF operation momentarily. This prevents the AF from being thrown off by any obstacle passing between the camera and subject. The exposure is set at the moment the picture is taken.

**3: AE/AF, no AE lock**

This is useful for subjects that keep moving and stopping repeatedly. During AI Servo AF, you can press the <✳> button to start or stop the AI Servo AF operation. The exposure is set at the moment the picture is taken. Thus, you can set your camera, so that the optimum focusing and exposure can be achieved and wait for the decisive moment.



#### During Live View shooting or movie shooting

- With setting 1 or 3, press the <✳> button for One-Shot AF. Also, AF will not take effect for shooting during touch shutter.
- With setting 2, press the shutter button halfway for One-Shot AF.

## C.Fn-11 Assign SET button

You can assign a frequently-used function to <SET>. When the camera is ready to shoot, pressing the <SET> button will display the respective function setting screen.

**0: Normal (disabled)**

**1: Image quality**

The image quality setting screen will appear.

**2: Flash exposure compensation**

The flash exposure compensation setting screen will appear.

**3: LCD monitor On/Off**

You can turn on or off the LCD monitor.

**4: Menu display**

The menu screen will appear.

**5: ISO speed**

The ISO speed setting screen will appear.

**6: Flash function settings**

The built-in flash or external flash function setting screen will appear.

## C.Fn-12 LCD display when power ON

**0: Display on**

When the power switch is turned on, the shooting settings will be displayed (p.61).

**1: Previous display status**

If you press the <DISP.> button and turn off the camera while the LCD monitor is off, the shooting settings will not be displayed when you turn on the camera again. This helps to save battery power. The menu screens and image playback will still function when used.

If you press the <DISP.> button to display the shooting settings and then turn off the camera, the shooting settings will be displayed when you turn on the camera again.



## C.Fn-13 Retract lens on power off

This is to set the lens retraction mechanism for when a gear-driven STM lens (such as EF40mm f/2.8 STM) is attached to the camera. You can set it to retract the extended lens automatically when the camera's power switch is set to <OFF>.

**0: Enable**

**1: Disable**



- With auto power off, the lens will not retract regardless of the setting.
- Before detaching the lens, make sure that it is retracted.



With setting 0, this function takes effect regardless of the lens's focus mode switch setting (AF or MF).

## MENU Registering My Menu ☆

Under the My Menu tab, you can register up to six menu options and Custom Functions whose settings you change frequently.

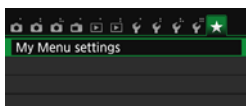

- 1 **Select [My Menu settings].**
- Under the [★] tab, select **[My Menu settings]**, then press <SET>.

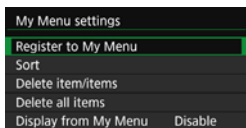

- 2 **Select [Register to My Menu].**
- Select **[Register to My Menu]**, then press <SET>.

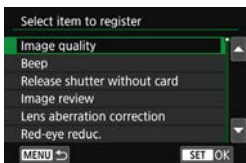

- 3 **Register the desired items.**
- Select the item, then press <SET>.
  - On the confirmation dialog, select **[OK]** and press <SET> to register the item.
  - You can register up to six items.
  - To return to the screen in step 2, press the <MENU> button.

### My Menu Settings

#### • Sort

You can change the order of the registered items in My Menu. Select **[Sort]** and select the item whose order you want to change. Then press <SET>. With [◆] displayed, press the <▲> <▼> keys to change the order, then press <SET>.

#### • Delete item/items and Delete all items

You can delete any of the registered items. **[Delete item/items]** deletes one item at a time, and **[Delete all items]** deletes all registered items.

#### • Display from My Menu

When **[Enable]** is set, the [★] tab will be displayed first when you display the menu screen.

# 14

## Reference

This chapter provides reference information for camera features, system accessories, etc.



### Certification Logo

Select [**F4: Certification Logo Display**] and press < (SET) > to display some of the logos of the camera's certifications. Other certification logos can be found in this Instruction Manual, on the camera body, and on the camera's package.

## MENU Checking the Battery Information

You can check the battery's condition on the LCD monitor.

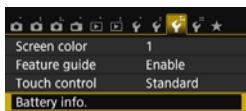

### Select [Battery info.].

- Under the [**3**] tab, select [**Battery info.**], then press <SET>.
- The battery info. screen will appear.

Battery position

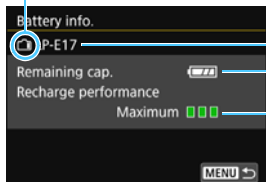

Battery model or household power source being used.

The battery level icon (p.41) is displayed.

Battery's recharge performance level is displayed in one of three levels.

■■■ (Green) : Battery's recharge performance is fine.

■■□ (Green) : Battery's recharge performance is slightly degraded.

■□□ (Red) : Purchasing a new battery is recommended.

 The use of a genuine Canon Battery Pack LP-E17 is recommended. If you use batteries that are not genuine Canon products, this camera's full performance may not be attained or malfunction may result.

-  The battery information will be displayed even when Battery Grip BG-E18 is used. If two LP-E17 battery packs are attached, it displays the remaining battery level of the two combined.
- If a battery communication error message is displayed, follow the message.

## Using a Household Power Outlet

With AC Adapter Kit ACK-E18 (sold separately), you can connect the camera to a household power outlet and not worry about the remaining battery level.

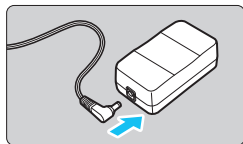

### 1 Connect the DC Coupler's plug.

- Connect the DC Coupler's plug to the AC Adapter's socket.

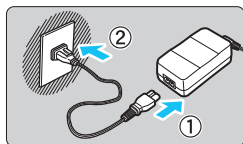

### 2 Connect the power cord.

- Connect the power cord as shown in the illustration.
- After using the camera, unplug the power plug from the power outlet.

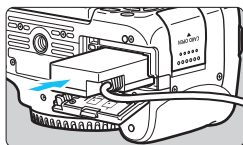

### 3 Insert the DC Coupler.

- Open the battery compartment cover and insert the DC Coupler until it securely locks in place.

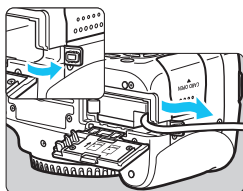

### 4 Push in the DC cord.

- Open the DC cord hole cover and install the cord as shown in the illustration.
- Close the battery compartment cover.



Do not connect or disconnect the power cord when the camera's power switch is set to <ON>.

# Remote Control Shooting

## Remote Controller RC-6 (Sold Separately)

This remote controller enables you to take pictures wirelessly up to approx. 5 meters/16.4 feet away from the camera. You can either shoot immediately or use a 2-sec. delay.

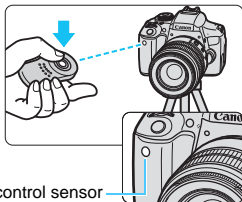

Remote control sensor

- Set the drive mode to  $\langle \text{☺} \text{ } \text{☺} \rangle$  (p.114).
- Point the remote controller toward the camera's remote control sensor and press the transmit button.
- ▶ The camera will autofocus.
- ▶ When focus is achieved, the self-timer lamp will light up and the picture will be taken.

- Fluorescent or LED lighting may cause camera misoperation by triggering the shutter inadvertently. Try to keep the camera away from such light sources.
- If you point a remote controller for a TV set toward the camera and operate it, it may cause camera misoperation by triggering the shutter inadvertently.

- Remote Controller RC-1/RC-5 (sold separately) can also be used.
- Remote control shooting is also possible with an EX-series Speedlite equipped with a remote-release function.
- The Remote Controller can also be used during movie shooting (p.221). Note that Remote Controller RC-5 cannot be used to take still photos in the movie shooting mode.

## Remote Switch RS-60E3 (Sold Separately)

Remote Switch RS-60E3 (sold separately) comes with an approx. 60 cm/2.0 ft cord. When connected to the camera's remote control terminal, it can be pressed halfway and completely, just like the shutter button.

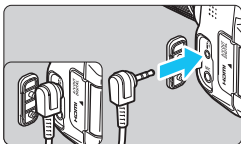

## Using the Eyepiece Cover

When you use the self-timer, bulb, or Remote Switch and do not look through the viewfinder, stray light entering the viewfinder can cause the picture to look dark. To prevent this, use the eyepiece cover (p.33) attached to the camera strap.

**During Live View shooting and movie shooting, attaching the eyepiece cover is unnecessary.**

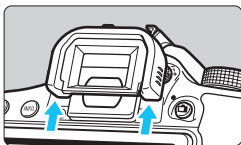

### 1 Detach the eyecup.

- Push the bottom of the eyecup to detach it.

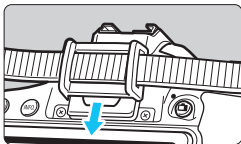

### 2 Attach the eyepiece cover.

- Slide the eyepiece cover down into the eyepiece groove to attach it.
- After you finish shooting, detach the eyepiece cover and attach the eyecup by sliding it down into the eyepiece groove.

## Using Eye-Fi Cards

With a commercially-available Eye-Fi card already set up, you can automatically transfer captured images to a computer or upload them to an online service via a wireless LAN.



The image transfer is a function of the Eye-Fi card. For instructions on how to set up and use the Eye-Fi card or to troubleshoot any image transfer problems, refer to the Eye-Fi card's instruction manual or contact the card manufacturer.

 **The camera is not guaranteed to support Eye-Fi card functions (including wireless transfer). In case of a problem with an Eye-Fi card, please check with the card manufacturer. Also note that approval is required to use Eye-Fi cards in many countries or regions. Without approval, use of the card is not permitted. If it is unclear whether the card has been approved for use in your area, please check with the card manufacturer.**

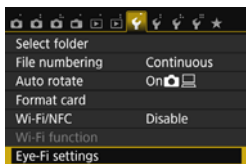
### 1 Insert an Eye-Fi card (p.37).



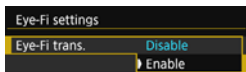

### 2 Select [Eye-Fi settings].

- Under the [ 1] tab, select [**Eye-Fi settings**], then press <  >.
- This menu is displayed only when an Eye-Fi card is inserted into the camera.



### 3 Enable Eye-Fi transmission.

- Select [**Eye-Fi trans.**], then press <  >.
- Select [**Enable**], then press <  >.
- If you set [**Disable**], there will be no automatic transmission even with the Eye-Fi card inserted (transmission status icon ).

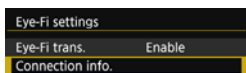

### 4 Display the connection information.

- Select [**Connection info.**], then press <  >.





## 5 Check the [Access point SSID:].





- Check that an access point is displayed for [Access point SSID:].
- You can also check the Eye-Fi card's MAC address and firmware version.
- Press the <MENU> button three times to exit the menu.



Transmission status icon

## 6 Take the picture.

- ▶ The picture is transferred and the <Wi-Fi> icon switches from gray (not connected) to one of the icons below.
- For transferred images,  is displayed in the shooting information display (p.306).

-  (Gray) **Not connected** : No connection with access point.
-  (Blinking) **Connecting...** : Connecting to access point.
-  (Illuminated) **Connected**: Connection to access point established.
-  (t) **Transferring...** : Image transfer to access point in progress.

## ⚠ Cautions for Using Eye-Fi Cards

- If [1:Wi-Fi/NFC] is set to [Enable], image transfer with an Eye-Fi card is not possible.
- If "⚠" is displayed, an error occurred while retrieving the card information. Turn the camera's power switch off and on again.
- Even if [Eye-Fi trans.] is set to [Disable], it may still transmit a signal. In hospitals, airports, and other places where wireless transmissions are prohibited, remove the Eye-Fi card from the camera.
- If the image transfer does not function, check the Eye-Fi card and computer settings. For details, refer to the card's instruction manual.
- Depending on the wireless LAN's connection conditions, the image transfer may take longer or it may be interrupted.
- The Eye-Fi card may become hot as it transmits.
- The battery power will be consumed faster.
- During the image transfer, auto power off will not take effect.
- If you insert a wireless LAN card other than an Eye-Fi card, [Eye-Fi settings] will not appear. Also, the transmission status icon <Wi-Fi> will not appear.

# Function Availability Table by Shooting Mode

## Still Photo Shooting in Basic Zone Modes

● : Set automatically ○ : User selectable □ : Not selectable/Disabled

Function		A+	S	CA	AF	M	M	M	SCN					
									1	2	3	4	5	6
All image quality settings selectable		○	○	○	○	○	○	○	○	○	○	○	○ <sup>*1</sup>	○ <sup>*1</sup>
ISO speed	Automatically set/Auto	●	●	●	●	●	●	●	●	●	●	●	●	●
	Manually set													
Picture Style	Automatically set/Auto	SCA	SCA	SCA	SCA	SCA	SCA	SCA	SCA	SCA	SCA	SCA	SCA	SCA
	Manual selection													
Extra Effect Shot <sup>*1</sup>				○										
Ambience-based shots				○	○	○	○	○	○	○	○	○	○	
Lighting/scene based shots					○	○	○	○						
Background blur				○										
Color tone									○	○				
Creative filters <sup>*1*2</sup>		○	○	○	○	○	○	○	○		○			
White balance	Auto	●	●	●	●	●	●	●	●	●	●	●	●	●
	Preset													
	Custom													
	Correction/Bracketing													
Auto Lighting Optimizer		●	●	●	●	●	●	●	●	●	●	●	●	●
Lens aberration correction	Peripheral illumination correction	○	○	○	○	○	○	○	○	○	○	○	○	○
	Chromatic aberration correction	○	○	○	○	○	○	○	○	○	○	○	○	○
	Distortion correction	○	○	○	○	○	○	○	○	○	○			
Long exposure noise reduction														
High ISO speed noise reduction		●	●	●	●	●	●	●	●	●	●	●	●	●
Highlight tone priority														
Anti-flicker shooting <sup>*3</sup>		●	●	●	●	●	●	●	●	●	●	●	●	●
Color space	sRGB	●	●	●	●	●	●	●	●	●	●	●	●	●
	Adobe RGB													
Metering mode	Evaluative metering	●	●	●	●	●	●	●	●		●	●	●	●
	Center-weighted average metering									●				
	Metering mode selection													

\*1: RAW + L or RAW cannot be selected.

\*2: Settable only during Live View shooting.

\*3: Works only during viewfinder shooting.

Function		A+	[ ]	CA	[ ]	[ ]	[ ]	[ ]	SCN					
									[ ]	[ ]	[ ]	[ ]	[ ]	[ ]
AF operation (Viewfinder shooting)	One-Shot AF				●	●	●		●	●	●	●	●	
	AI Servo AF						●	●						
	AI Focus AF	●	●	●										
AF operation (Live View shooting)	One-Shot AF	●	●	●	●	●	●	●	●		●	●	●	
AF	AF area selection mode													
	AF point selection	●	●	●	●	●	●	●	●	●	●	●	●	
	AF-assist beam	●		●	●	●			●	●	●	●	●	
	Continuous AF <sup>2</sup>	○	○	○	○	○	○	○	○	○	○	○	○	
Exposure	Program shift													
	Exposure compensation													
	AEB													
	AE lock													
	Depth-of-field preview													
Drive mode	Single shooting	○	○	○	○	○	○	○	○	○	○	○	○	
	Continuous shooting	○	○	○	○	○	○	○	○	○	○	○	○	
	Silent single shooting <sup>*3</sup>	○	○	○	○	○	○	○	○	○	○	○	○	
	Silent continuous shooting <sup>*3</sup>	○	○	○	○	○	○	○	○	○	○	○	○	
	Self-timer	○	○	○	○	○	○	○	○	○	○	○	○	
Built-in flash	Automatic firing	○		○	○		○				●			
	Manual firing	○		○	○		○	○				○		
	Flash off	○	●	○	○	●	○	○	○	●		○	●	
	Red-eye reduction	○		○	○		○	○			○	○		
	FE lock <sup>*3</sup>													
	Flash exposure compensation													
	Wireless control													
External flash	Function settings													
	Custom Function settings													
Live View shooting		○	○	○	○	○	○	○	○		○	○	○	
Aspect ratio														
Quick Control		○	○	○	○	○	○	○	○	○	○	○	○	
Feature guide		○	○	○	○	○	○	○	○	○	○	○	○	

## Still Photo Shooting in Creative Zone Modes

● : Set automatically ○ : User selectable □ : Not selectable/Disabled

Function		P	Tv	Av	M
<b>All image quality settings selectable</b>		○	○	○	○
<b>ISO speed</b>	Automatically set/Auto	○	○	○	○
	Manually set	○	○	○	○
<b>Picture Style</b>	Automatically set/Auto	○	○	○	○
	Manual selection	○	○	○	○
<b>Extra Effect Shot</b>					
<b>Ambience-based shots</b>					
<b>Lighting/scene based shots</b>					
<b>Background blur</b>					
<b>Color tone</b>					
<b>Creative filters</b> <sup>*1*2</sup>		○	○	○	○
<b>White balance</b>	Auto	○	○	○	○
	Preset	○	○	○	○
	Custom	○	○	○	○
	Correction/Bracketing	○	○	○	○
<b>Auto Lighting Optimizer</b>		○	○	○	○
<b>Lens aberration correction</b>	Peripheral illumination correction	○	○	○	○
	Chromatic aberration correction	○	○	○	○
	Distortion correction	○	○	○	○
<b>Long exposure noise reduction</b>		○	○	○	○
<b>High ISO speed noise reduction</b>		○	○	○	○
<b>Highlight tone priority</b>		○	○	○	○
<b>Anti-flicker shooting</b> <sup>*3</sup>		○	○	○	○
<b>Color space</b>	sRGB	○	○	○	○
	Adobe RGB	○	○	○	○
<b>Metering mode</b>	Evaluative metering	○	○	○	○
	Metering mode selection	○	○	○	○

\*1: RAW +  or RAW cannot be selected.

\*2: Settable only during Live View shooting.

\*3: Works only during viewfinder shooting.

Function		P	Tv	Av	M
AF operation (Viewfinder shooting)	One-Shot AF	○	○	○	○
	AI Servo AF	○	○	○	○
	AI Focus AF	○	○	○	○
AF operation (Live View shooting)	One-Shot AF	●	●	●	●
AF	AF area selection mode	○	○	○	○
	AF point selection	○	○	○	○
	AF-assist beam	○	○	○	○
	Continuous AF* <sup>2</sup>	○	○	○	○
Exposure	Program shift	○			
	Exposure compensation	○	○	○	
	AEB	○	○	○	○
	AE lock	○	○	○	* <sup>4</sup>
	Depth-of-field preview	○	○	○	○
Drive mode	Single shooting	○	○	○	○
	Continuous shooting	○	○	○	○
	Silent single shooting* <sup>3</sup>	○	○	○	○
	Silent continuous shooting* <sup>3</sup>	○	○	○	○
	Self-timer	○	○	○	○
Built-in flash	Automatic firing				
	Manual firing	○	○	○	○
	Flash off	○	○	○	○
	Red-eye reduction	○	○	○	○
	FE lock	○	○	○	○
	Flash exposure compensation	○	○	○	○
External flash	Wireless control	○	○	○	○
	Function settings	○	○	○	○
	Custom Function settings	○	○	○	○
Live View shooting		○	○	○	○
Aspect ratio		○	○	○	○
Quick Control		○	○	○	○
Feature guide		○	○	○	○

\*4: With ISO Auto, you can set a fixed ISO speed.

## Movie Shooting

● : Set automatically ○ : User selectable □ : Not selectable/Disabled

Function		Movies											Still Photos			
		A+	+	CA	Ⓜ	Ⓜ	Ⓜ	Ⓜ	SCN	P	Tv	Av	M	📷*1		
		ⓂA+											ⓂM	ⓂA+	ⓂM	ⓂM
<b>All image quality settings selectable (movie)</b>		○	○	○	○	○	○	○	○	○	○	○	○			
<b>All image quality settings selectable (still photos)</b>														○	○	○
<b>Video snapshot</b>		○	○	○	○	○	○	○	○	○	○	○				
<b>Miniature effect movie</b>		○	○	○	○	○	○	○	○	○	○	○	○	○	○	○
<b>ISO speed</b>	Automatically set/Auto	●	●	●	●	●	●	●	●	●	●	○	●	●	○	
	Manually set											○			○	
<b>Picture Style</b>	Automatically set/Auto	●	●	●	●	●	●	●	○	○	○	○	●	○	○	
	Manual selection								○	○	○	○		○	○	
<b>White balance</b>	Auto	●	●	●	●	●	●	●	○	○	○	○	●	○	○	
	Preset								○	○	○	○		○	○	
	Custom								○	○	○	○		○	○	
	Correction								○	○	○	○		○	○	
	Bracketing													○	○	
<b>Auto Lighting Optimizer</b>		●	●	●	●	●	●	●	○	○	○	○	●	○	○	
<b>Lens aberration correction</b>	Peripheral illumination correction	○	○	○	○	○	○	○	○	○	○	○	○	○	○	
	Chromatic aberration correction	○	○	○	○	○	○	○	○	○	○	○	○	○	○	
	Distortion correction															
<b>Long exposure noise reduction</b>																
<b>High ISO speed noise reduction</b>																
<b>Highlight tone priority</b>									○	○	○	○		○	○	
<b>Color space</b>	sRGB	●	●	●	●	●	●	●	●	●	●	●	●	○	○	
	Adobe RGB													○	○	

\*1: The 📷 icon indicates still photo shooting during movie shooting.

\*2: Still photos with a Miniature effect will be taken.

Function		Movies											Still Photos				
									SCN	P	Tv	Av	M	<sup>1</sup>			
		A <sup>+</sup>									M	A <sup>+</sup>		M			
<b>Metering mode</b>																	
<b>AF</b>	Face+Tracking	○	○	○	○	○	○	○	○	○	○	○	○	○	○	○	○
	FlexiZone - Multi	○	○	○	○	○	○	○	○	○	○	○	○	○	○	○	○
	FlexiZone - Single	○	○	○	○	○	○	○	○	○	○	○	○	○	○	○	○
	Manual focus (MF)	○	○	○	○	○	○	○	○	○	○	○	○	○	○	○	○
	Movie Servo AF	○	○	○	○	○	○	○	○	○	○	○	○	○	○	○	○
<b>Exposure</b>	Program shift																
	AE lock								○	○	○		*3		○		*3
	Exposure compensation								○	○	○				○		
	AEB																
	Depth-of-field preview																
<b>Drive mode</b>	Single shooting														○	○	○
	Continuous shooting*4														○	○	○
	Silent single shooting																
	Silent continuous shooting																
	Self-timer*4														○	○	○
<b>Built-in flash</b>																	
<b>Aspect ratio</b>																	
<b>Sound recording</b>		○	○	○	○	○	○	○	○	○	○	○	○				
<b>Quick Control</b>		○	○	○	○	○	○	○	○	○	○	○	○	○	○	○	○

\*3: With ISO Auto, you can set a fixed ISO speed.

\*4: Works only before you start shooting a movie.

# System Map

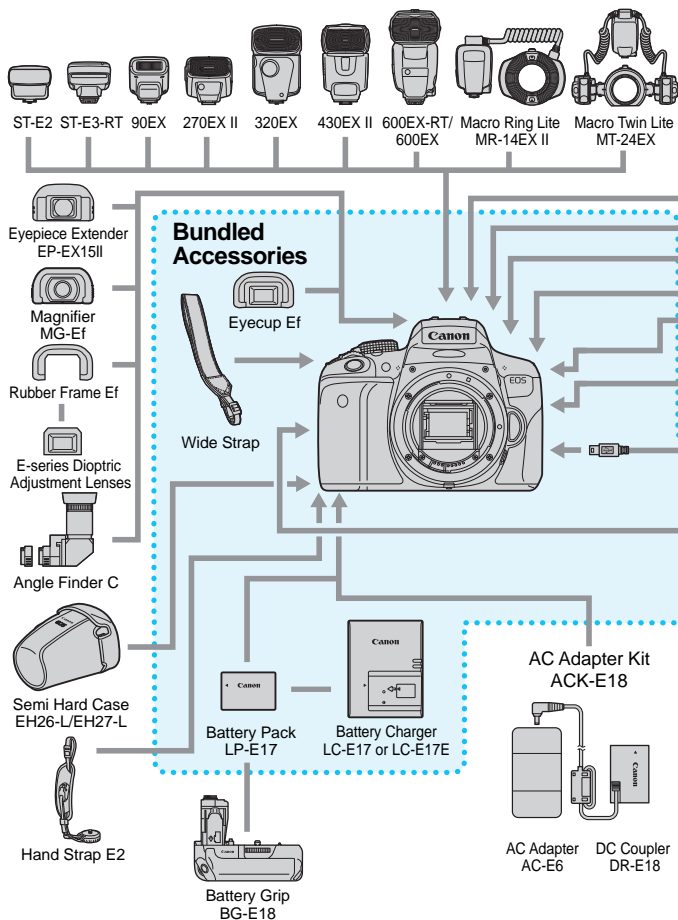



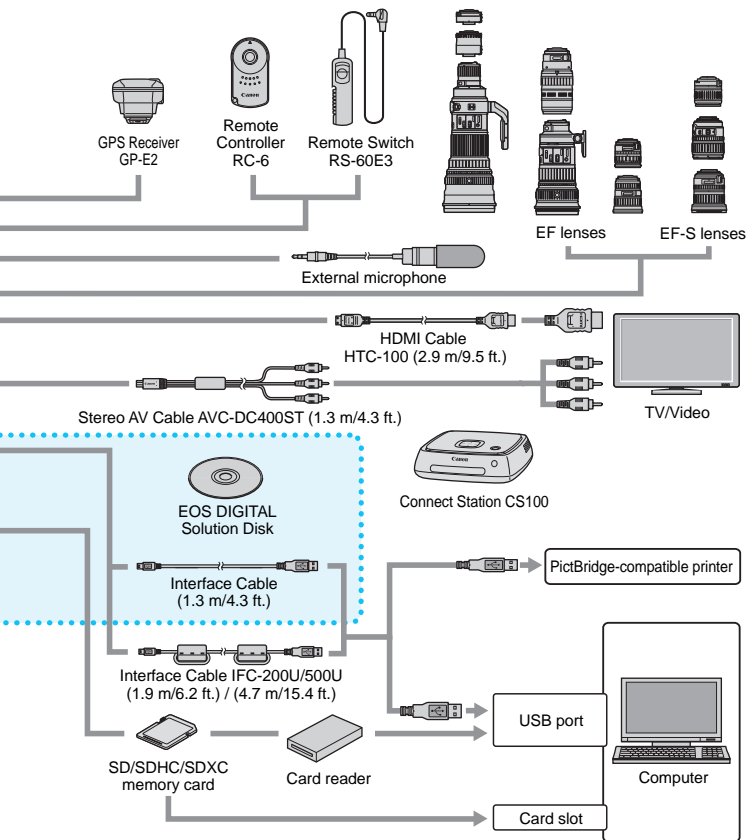

\* All cable lengths given are approximate figures.

# MENU Menu Settings

## Viewfinder Shooting and Live View Shooting

### 📷 Shooting 1 (Red)

Page

Image quality	L /  L /  M /  M /  S1 /  S1 / S2 / S3 / RAW +  L / RAW*	116
Beep	Enable / Touch to  / Disable	256
Release shutter without card	Enable / Disable	256
Image review	Off / 2 sec. / 4 sec. / 8 sec. / Hold	257
Lens aberration correction	Peripheral illumination correction: Enable / Disable	140
	Chromatic aberration correction: Enable / Disable	
	Distortion correction: Disable / Enable	
Red-eye reduction	Disable / Enable	167
Flash control	Flash firing / E-TTL II metering / Flash sync. speed in Av mode / Built-in flash settings / External flash function settings / External flash C.Fn setting / Clear settings	173

\* Not selectable in the and modes.

### 📷 Shooting 2 (Red)

Exposure compensation/AEB	1/3-stop or 1/2-stop increments, $\pm 5$ stops (AEB: $\pm 2$ stops)	160
Auto Lighting Optimizer	Disable / Low / Standard / High	136
	Disabled in manual exposure	
Custom White Balance	Manual setting of white balance	132
White balance shift/bracketing	WB correction: White balance correction	134
	BKT setting: White balance bracketing	135
Color space	sRGB / Adobe RGB	146
Picture Style	Auto /  Standard /  Portrait /  Landscape /  Neutral /  Faithful /  Monochrome /  User Def. 1-3	125
Metering mode	Evaluative metering /  Partial metering /  Spot metering /  Center-weighted average metering	157

Shaded menu options are not displayed in Basic Zone modes.

 Shooting 3 (Red)

Page

Dust Delete Data	Obtain data to be used by EOS software to delete dust spots	272
ISO Auto	Max. ISO 400, Max. ISO 800, Max. ISO 1600, Max. ISO 3200, Max. ISO 6400	123
Long exposure noise reduction	Disable / Auto / Enable	138
High ISO speed noise reduction	Disable / Low / Standard / High / Multi Shot Noise Reduction	137
Aspect ratio	3:2 / 4:3 / 16:9 / 1:1	120
Anti-flicker shooting	Disable / Enable	144

 Live View Shooting (Red)

Live View shooting	Enable / Disable	193
AF method	☺+Tracking / FlexiZone - Multi / FlexiZone - Single	206
Continuous AF	Enable / Disable	204
Touch Shutter	Disable / Enable	214
Grid display	Off / Grid 1 ㉑ / Grid 2 ㉒	204
Metering timer	4 sec. / 8 sec. / 16 sec. / 30 sec. / 1 min. / 10 min. / 30 min.	205

 Playback 1 (Blue)



Protect images	Protect images	302
Rotate image	Rotate images	283
Erase images	Erase images	304
Print order	Specify images to be printed (DPOF)	329
Photobook Set-up	Specify images for a photobook	333
Creative filters	Grainy B/W / Soft focus / Fish-eye effect / Art bold effect / Water painting effect / Toy camera effect / Miniature effect	312
Resize	Downsize JPEG image's pixel count	315

**▶ Playback 2 (Blue)**

Page

<b>Cropping</b>	Crop part of the image	317
<b>Rating</b>	[OFF] / [.] / [.] / [.] / [.] / [.]	284
<b>Slide show</b>	Playback description / Display time / Repeat / Transition effect / Background music	294
<b>Image jump with</b> 	1 image / 10 images / 100 images / Date / Folder / Movies / Stills / Rating	279
<b>AF point display</b>	Disable / Enable	309
<b>Histogram display</b>	Brightness / RGB	310
<b>Control over HDMI</b>	Disable / Enable	299

**🔧 Set-up 1 (Yellow)**

<b>Select folder</b>	Create and select a folder	259
<b>File numbering</b>	Continuous / Auto reset / Manual reset	261
<b>Auto rotate</b>	On   / On  / Off	265
<b>Format card</b>	Initialize and erase data on the card	59
<b>Wi-Fi/NFC</b>	Disable / Enable Allow NFC connections	-*
<b>Wi-Fi function</b>	Transfer images between cameras / Connect to smartphone / Print from Wi-Fi printer / Upload to Web service / View images on DLNA devices	
<b>Eye-Fi settings</b>	Displayed when a commercially-available Eye-Fi card is inserted	352

\* For details, refer to the Wi-Fi/NFC Function Instruction Manual on the CD-ROM.

## 🔧 Set-up 2 (Yellow)

Page

<b>Auto power off</b>	30 sec. / 1 min. / 2 min. / 4 min. / 8 min. / 15 min. / Disable	257
<b>LCD brightness</b>	Adjust the brightness (seven levels)	258
<b>LCD off/on button</b>	Shutter button / Shutter/DISP. / Remains on	270
<b>Date/Time/Zone</b>	Date (year, month, day) / Time (hr., min., sec.) / Daylight saving time / Time zone	42
<b>Language</b> 	Select the interface language	44
<b>Viewfinder display</b>	Grid display: Hide / Show	62
	Flicker detection: Show / Hide	63
<b>GPS device settings</b>	Settings available when the GPS Receiver GP-E2 (sold separately) is attached	-



- When using Wi-Fi function or GPS device, be sure to check the countries and areas of use, and use the device in accordance with the laws and regulations of the country or region.
- **[Wi-Fi/NFC]** cannot be set if the camera is connected to a computer, printer, GPS receiver, TV set, or other device with a cable. When **[Wi-Fi/NFC]** is set to **[Enable]**, you cannot connect the camera to the above devices with a cable.
- When connecting this camera and the GPS Receiver GP-E2 with a cable, update the firmware of GP-E2 to Ver.2.0.0 or later. With the older versions, you cannot use this camera and GP-E2 connected with a cable. Note that GP-E2 can be used by attaching it to the camera's hot shoe.

For how to update the firmware, refer to the Canon Web site or contact the nearest Canon Service Center.

**☛ Set-up 3 (Yellow)**

Page

<b>Screen color</b>	Select the shooting settings screen color	270
<b>Feature guide</b>	Enable / Disable	64
<b>Touch control</b>	Standard / Sensitive / Disable	58
<b>Battery information</b>	Remaining capacity / Recharge performance	348
<b>Sensor cleaning</b>	Auto cleaning: Enable / Disable	271
	Clean now	
	Clean manually	274
<b>Video system</b>	NTSC / PAL	298

**☛ Set-up 4 (Yellow)**

<b>Certification Logo Display</b>	Displays some of the logos of the camera's certifications	347
<b>Custom Functions (C.Fn)</b>	Customize camera functions as desired	338
<b>Copyright information</b>	Display copyright information / Enter author's name / Enter copyright details / Delete copyright information	263
<b>Clear settings</b>	Clear all camera settings / Clear all Custom Func. (C.Fn)	267
<b>📷 firmware ver.*</b>	For updating the firmware	-

\* During firmware updates, the touch screen will be disabled to prevent accidental operations.

**★ My Menu (Green)**

<b>My Menu settings</b>	Register frequently-used menu options and Custom Functions	346
-------------------------	--	-----

## Movie Shooting

### Shooting 1 (Red)

Page

Image quality	L /  L /  M /  M /  S1 /  S1 / S2 / S3 / RAW +  L / RAW	116
Beep	Enable / Touch to  / Disable	256
Release shutter without card	Enable / Disable	256
Image review	Off / 2 sec. / 4 sec. / 8 sec. / Hold	257
Lens aberration correction	Peripheral illumination correction: Enable / Disable	140
	Chromatic aberration correction: Enable / Disable	

### Shooting 2 (Red)

Exposure compensation	1/3-stop or 1/2-stop increments, $\pm 3$ stops	160
Auto Lighting Optimizer	Disable / Low / Standard / High	136
	Disable during manual exposure	
Custom white balance	Manual setting of white balance	132
White balance shift/bracketing	WB correction: White balance correction	134
	BKT setting: White balance bracketing	135
Color space	sRGB / Adobe RGB	146
Picture Style	Auto /  Standard /  Portrait /  Landscape /  Neutral /  Faithful /  Monochrome /  User Def. 1-3	125





- Shaded menu options are not displayed in Basic Zone modes.
- The menu tabs and options displayed will differ between viewfinder shooting/Live View shooting and movie shooting. Note that the menu tabs and options displayed in [▶1] Playback 1, [▶2] Playback 2, [👤1] Set-up 1 to [👤4] Set-up 4 and [★] My Menu are the same as those displayed in viewfinder shooting/Live View shooting (p.363-366).
- The [👤1] and [👤2] menu tabs will appear only for movie shooting.

 Shooting 3 (Red)

Page

<b>Dust Delete Data</b>	Obtain data to be used by EOS software to delete dust spots	272
-------------------------	---	-----

 Movie 1 (Red)

<b>AF method</b>	+Tracking / FlexiZone - Multi / FlexiZone - Single	248
<b>Movie Servo AF</b>	Enable / Disable	248
<b>AF with shutter button during movie shooting</b> 	One-Shot AF / Disable	250
<b>Grid display</b>	Off / Grid 1  / Grid 2 	250
<b>Metering timer</b>	4 sec. / 8 sec. / 16 sec. / 30 sec. / 1 min. / 10 min. / 30 min.	250

 Movie 2 (Red)

<b>Movie recording size</b>	<ul style="list-style-type: none"> <li>• 1920x1080 / 1280x720 / 640x480</li> <li>• NTSC: 59.94p / 29.97p / 23.98p</li> <li>• PAL: 50.00p / 25.00p</li> <li>• Standard / Light</li> </ul>	233
<b>Sound recording*</b>	Sound recording: Auto / Manual / Disable	251
	Recording level	
	Wind filter: Auto / Disable Attenuator: Disable / Enable	
<b>Video snapshot</b>	Video snapshot: Enable / Disable	238
	Album settings: Create a new album / Add to existing album	
	Show confirm message: Enable/Disable	

\* In Basic Zone modes, [Sound recording] will be set to [On/Off].



# Troubleshooting Guide

If a problem occurs with the camera, first consult this Troubleshooting Guide. If this Troubleshooting Guide does not resolve the problem, contact your dealer or nearest Canon Service Center.

## Power-Related Problems

### The battery pack does not recharge.

- Do not use any battery pack other than a genuine Battery Pack LP-E17.

### The battery charger's lamp blinks.

- If (1) the battery charger or battery pack has a problem or (2) communication with the battery pack failed (with a non-Canon battery pack), the protection circuit will stop charging, and the charge lamp will blink in orange. In the case of (1), unplug the charger's power plug from the power outlet. Detach and reattach the battery pack to the charger. Wait a few minutes, then reconnect the power plug to the power outlet. If the problem persists, contact your dealer or nearest Canon Service Center.

### The camera does not operate even when the power switch is set to <ON>.

- Make sure the battery is properly installed in the camera (p.36).
- Make sure the battery compartment cover is closed (p.36).
- Make sure the card slot cover is closed (p.37).
- Recharge the battery (p.34).
- Press the <DISP.> button (p.61).

### The access lamp still blinks even when the power switch is set to <OFF>.

- If the power is turned off while an image is being recorded to the card, the access lamp will remain on/continue to blink for a few seconds. When the image recording is completed, the power will turn off automatically.

### **[Battery communication error. Does this battery/do these batteries display the Canon logo?] is displayed.**

- Do not use any battery pack other than a genuine Battery Pack LP-E17.
- Remove and install the battery again (p.36).
- If the battery contacts are dirty, use a soft cloth to clean them.

### **The battery becomes exhausted quickly.**

- Use a fully-charged battery pack (p.34).
- The battery performance may have degraded. See [**▼3: Battery info.**] to check the battery's recharge performance level (p.348). If the battery performance is poor, replace the battery pack with a new one.
- The rechargeable battery pack performance will degrade over repeated use. Purchase a new one.
- The number of possible shots will decrease with any of the following operations:
  - Pressing the shutter button halfway for a prolonged period.
  - Activating the AF frequently without taking a picture.
  - Using the lens's Image Stabilizer.
  - Using the LCD monitor frequently.
  - Continuing Live View shooting or movie shooting for a prolonged period.
  - The Eye-Fi card's communication function is operating.

### **The camera turns off by itself.**

- Auto power off is in effect. If you do not want auto power off to take effect, set [**▼2: Auto power off**] to [**Disable**] (p.257).
- Even if [**▼2: Auto power off**] is set to [**Disable**], the LCD monitor will still turn off after the camera is left idle for 30 min. (The camera's power does not turn off.) Press the <DISP.> button to turn on the LCD monitor.

## Shooting-Related Problems

### The lens cannot be attached.

- The camera cannot be used with EF-M lenses (p.45).

### The viewfinder is dark.

- Install a recharged battery pack in the camera (p.34).

### No images can be shot or recorded.

- Make sure the card is properly inserted (p.37).
- Slide the card's write-protect switch to the write/erase position (p.37).
- If the card is full, replace the card or delete unnecessary images to make space (p.37, 304).
- If you try to focus in the One-Shot AF mode and the focus indicator <●> in the viewfinder blinks, a picture cannot be taken. Press the shutter button halfway again to refocus automatically, or focus manually (p.50, 111).

### The card cannot be used.

- If a card error message is displayed, see page 37 or 382.

### The image is out of focus.

- Set the lens's focus mode switch to <AF> (p.45).
- Press the shutter button gently to prevent camera shake (p.49-50).
- If the lens has an Image Stabilizer, set the IS switch to <ON>.
- In low light, the shutter speed may become slow. Use a faster shutter speed (p.150), set a higher ISO speed (p.122), use flash (p.166), or use a tripod.

### **I cannot lock the focus and recompose the shot.**

- Set the AF operation to One-Shot AF. Focus lock is not possible in the AI Servo AF mode, or when servo takes effect in AI Focus AF mode (p.100).

### **Linear noise or moire appears in the image.**

- Depending on the subject, linear noise or moire may be recorded in the image. It is likely to occur especially in the following cases.
  - Shooting fine horizontal stripes, lattice patterns, etc.
  - When there is an intense light source such as sunlight or lighting in or near the shooting range.

In such a case, noise and moire may be reduced by the following measures.

- Change the size of the subject by changing the focusing distance or zoom magnification.
- Recompose the shot to prevent an intense light source from entering the shooting range.
- Attach the lens hood to prevent intense light from entering the lens.
- If you use a TS-E lens and shift or tilt, linear noise or moire may be recorded in the image.

### **Horizontal stripes appear, or the exposure or color tone look strange.**

- Horizontal stripes (noise) or irregular exposures can be caused by fluorescent lighting, LED lighting, or other light sources during viewfinder or Live View shooting. Also, the exposure or color tone may not come out right. A slow shutter speed may solve the problem.

### The continuous shooting speed is slow.

- Depending on the lens type, shutter speed, aperture, subject conditions, brightness, etc., the continuous shooting speed may become slower.
- If [ **3: Anti-flicker shoot.**] is set to [**Enable**] and you shoot under a flickering light source, the continuous shooting speed may become slightly slower, or the continuous shooting interval may become irregular. Also, the time lag until shutter release may be slightly longer than usual (p.144).
- If you set [**Distortion**] to [**Enable**], the continuous shooting speed will decrease (p.141).

### The maximum burst during continuous shooting is lower.

- If you shoot something that has fine detail such as a field of grass, the file size will be larger, and the actual maximum burst may be lower than the number mentioned on page 117.

### ISO 100 cannot be set.

- Under [ **4: Custom Functions (C.Fn)**], if [**3: Highlight tone priority**] is set to [**1: Enable**], ISO 100 cannot be set. If [**0: Disable**] is set, ISO 100 can be set (p.339). This also applies to movie shooting (p.226).

### ISO speed [H] (equivalent to ISO 25600) cannot be set.

- Under [ **4: Custom Functions (C.Fn)**], if [**3: Highlight tone priority**] is set to [**1: Enable**], the [H] ISO speed (equivalent to ISO 25600) cannot be selected even when [**2: ISO expansion**] is set to [**1: On**]. If [**0: Disable**] is set for [**3: Highlight tone priority**], [H] can be set (p.339).

### The Auto Lighting Optimizer cannot be set.

- Under [ **4: Custom Functions (C.Fn)**], if [**3: Highlight tone priority**] is set to [**1: Enable**], the Auto Lighting Optimizer cannot be set. If [**0: Disable**] is set, the Auto Lighting Optimizer can be set (p.339).

### Even though I set a decreased exposure compensation, the image comes out bright.

- Set [ 2: Auto Lighting Optimizer] to [Disable]. When [Low], [Standard], or [High] is set, even if you set a decreased exposure compensation or flash exposure compensation, the image may come out bright (p.136).

### When I use the <Av> mode with flash, the shutter speed becomes slow.

- If you shoot at night when the background is dark, the shutter speed automatically becomes slow (slow-sync shooting) so that both the subject and background are properly exposed. To prevent a slow shutter speed, under [ 1: Flash control], set [Flash sync. speed in Av mode] to [1/200-1/60sec. auto] or [1/200 sec. (fixed)] (p.174).

### The built-in flash rises by itself.

- In shooting modes (< > < > < > < > < > < >) whose default setting is < > (Auto flash), the built-in flash will be raised automatically when necessary.
- In the < > and < > modes, when you press the shutter button halfway under low-light conditions, the built-in flash may be raised automatically and emit the AF-assist beam.

### The built-in flash does not fire.

- If you use the built-in flash too often in too short a period of time, the flash may stop firing for a while to protect the light-emitting unit.

### The external flash always fires at full output.

- If you use a flash unit other than an EX-series Speedlite, the flash will always be fired at full output (p.172).
- Under [**📷1: Flash control**], if [**Flash metering mode**] in [**External flash C.Fn setting**] is set to [**TTL flash metering**] (autoflash), the flash will always fire at full output (p.178).

### Flash exposure compensation cannot be set for the external Speedlite.

- If flash exposure compensation is set with the external Speedlite, flash exposure compensation cannot be set with the camera. When the external Speedlite's flash exposure compensation is canceled (set to 0), flash exposure compensation can be set with the camera.

### High-speed sync cannot be set in the <Av> mode.

- Under [**📷1: Flash control**], set [**Flash sync. speed in Av mode**] to [**Auto**] (p.174).

### The camera makes a small noise when it is shaken.

- A small noise may be heard when the camera's internal mechanism moves slightly.

### The shutter makes two shooting sounds during Live View shooting.

- If you use flash, the shutter will make two sounds each time you shoot (p.193).

### **During Live View or movie shooting, a white <H> or red <H> icon is displayed.**

- It indicates that the camera's internal temperature is high. If the white <H> icon is displayed, the still photo's image quality may deteriorate. If the red <H> icon is displayed, it indicates that the Live View or movie shooting will soon stop automatically (p.218, 253).

### **Movie shooting stops by itself.**

- If the card's writing speed is slow, movie shooting may stop automatically. Use an SD Speed Class 6 "CLASS 6" or faster card. To find out the card's reading/writing speed, refer to the card manufacturer's Web site, etc.
- If the movie shooting time reaches 29 min. 59 sec., the movie shooting will stop automatically.

### **The ISO speed cannot be set for movie shooting.**

- In shooting modes other than <M>, the ISO speed is set automatically. In the <M> mode, you can freely set the ISO speed (p.226).

### **The exposure changes during movie shooting.**

- If you change the shutter speed or aperture during movie shooting, the changes in the exposure may be recorded.
- Zooming the lens during movie shooting can cause changes in the exposure regardless of whether the lens's maximum aperture changes or not. The changes in the exposure may be recorded as a result.

### **The subject looks distorted during movie shooting.**

- If you move the camera to the left or right quickly (high-speed panning) or shoot a moving subject, the image may look distorted.



## The image flickers or horizontal stripes appear during movie shooting.

- Flickering, horizontal stripes (noise), or irregular exposures can be caused by fluorescent lighting, LED lighting, or other light sources during movie shooting. Also, changes in the exposure (brightness) or color tone may be recorded. In the <M> mode, a slow shutter speed may reduce the problem.

## Wi-Fi

### Wi-Fi cannot be set.

- If the camera is connected to a computer, printer, GPS receiver, TV set, or other device with a cable, Wi-Fi cannot be set ([**F1: Wi-Fi/NFC**] will be grayed out). Disconnect the cable before changing any settings.
- For details, refer to the Wi-Fi/NFC Function Instruction Manual.

## Operation Problems

### During touch screen operations, the beeper suddenly sounds softer.

- Check if your finger is blocking the speaker (p.26).

## Display Problems

### The menu screen shows fewer tabs and options.

- In Basic Zone modes and in movie shooting mode, certain tabs and menu options are not displayed. Set the shooting mode to a Creative Zone mode (p.53).

### **The file name's first character is an underscore (“\_”).**

- Set the color space to sRGB. If Adobe RGB is set, the first character will be an underscore (p.146).

### **The file name starts with “MVI\_”.**

- It is a movie file (p.262).

### **The file numbering does not start from 0001.**

- If the card already contains recorded images, the image number may not start from 0001 (p.262).

### **The shooting date and time displayed is incorrect.**

- Check that the correct date and time are set (p.42).
- Check the time zone and daylight saving time (p.42).

### **The date and time are not in the picture.**

- The shooting date and time do not appear in the picture. The date and time are instead recorded in the image data as shooting information. When printing, you can imprint the date and time in the picture, using the date and time recorded in the shooting information (p.325).

### **[###] is displayed.**

- If the number of images recorded on the card exceeds the number the camera can display, [###] will be displayed (p.285).

### **The LCD monitor does not display a clear image.**

- If the LCD monitor is dirty, use a soft cloth to clean it.
- In low or high temperatures, the LCD monitor display may seem slow or may look black. It will return to normal at room temperature.

**[Eye-Fi settings] does not appear.**

- **[Eye-Fi settings]** will appear only when an Eye-Fi card is inserted in the camera. If the Eye-Fi card has a write-protect switch set to the LOCK position, you will not be able to check the card's connection status or disable Eye-Fi transmission (p.352).

**Playback Problems****Part of the image blinks in black.**

- It is the highlight alert (p.310). Overexposed areas with clipped highlight will blink.

**The image cannot be erased.**

- If the image is protected, it cannot be erased (p.302).

**The movie cannot be played back.**

- Movies edited with a computer cannot be played back with the camera.

**Camera operation noise can be heard when the movie is played back.**

- If you operate the camera's dials or lens during movie shooting, the operation noise will also be recorded. Using an external microphone (commercially available) is recommended (p.251).

**The movie has still moments.**

- During autoexposure movie shooting, if there is a drastic change in the exposure level, the recording will stop momentarily until the brightness stabilizes. In such cases, shoot in <M> mode (p.225).

### No picture on the TV set.

- Check that the HDMI cable or stereo AV cable's plug is inserted all the way in (p.298-301).
- Set the [**F3: Video system**] correctly to [**NTSC**] or [**PAL**] (depending on the video system of your TV set).
- If [**F1: Wi-Fi/NFC**] is set to [**Enable**], the camera cannot be connected to a TV set. Set [**Wi-Fi/NFC**] to [**Disable**], then reconnect the camera to the TV set with the HDMI cable or stereo AV cable.

### There are multiple movie files for a single movie shoot.

- If the movie file size reaches 4 GB, another movie file will be created automatically (p.235).

### My card reader does not recognize the card.

- Depending on the card reader and computer OS used, SDXC cards may not be correctly recognized. In such a case, connect your camera to the computer with the interface cable, then transfer the images to your computer using EOS Utility (EOS software, p.404).

### I cannot resize the image. I cannot crop the image.

- JPEG **S3** and RAW images cannot be resized or cropped (p.315, p.317).

### A red box is displayed on the image.

- [**F2: AF point disp.**] is set to [**Enable**] (p.309).

### A red box is not displayed on the image.

- Even if [**F2: AF point disp.**] is set to [**Enable**] (p.309), the red box is not displayed for the following images:
  - Images shot with Multi Shot Noise Reduction (p.137)
  - Images recorded with distortion correction enabled (p.141)
  - Images shot with <F4> or <F5> in <SCN> mode
  - Cropped images (p.317)
  - Images with Fish-eye effect applied after shooting (p.312)

## Sensor Cleaning Problems

### The shutter makes a noise during sensor cleaning.

- If you selected [**Clean now** ], the shutter will make a noise, but no picture is taken (p.271).

### Automatic sensor cleaning does not work.



- If you repeatedly turn the power switch <ON> / <OFF> at a short interval, the < > icon may not be displayed (p.40).

## Printing-Related Problems

### There are fewer printing effects than listed in the instruction manual.

- Contents displayed on the screen vary depending on the printer. This instruction manual lists all the printing effects available (p.324).

### Direct printing does not work.

- If any of the following shooting modes or functions is set, the camera cannot be connected to a printer. Cancel all the relevant settings, then reconnect the camera to the printer with an interface cable.
  - < > or < > in <SCN> mode
  - Multi Shot Noise Reduction
  - [**Wi-Fi/NFC**] set to [**Enable**]

## Computer Connection Problems

### I cannot download images to a computer.

- Install the EOS software (EOS DIGITAL Solution Disk CD-ROM) on the computer (p.404).
- If [**Wi-Fi/NFC**] is set to [**Enable**], the camera cannot be connected to a computer. Set [**Wi-Fi/NFC**] to [**Disable**], then reconnect the camera to a computer with an interface cable.

# Error Codes

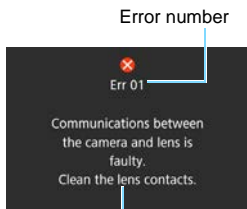

Cause and countermeasures

If there is a problem with the camera, an error message will appear. Follow the on-screen instructions.

Number	Error Message and Solution
01	<b>Communications between the camera and lens is faulty. Clean the lens contacts.</b>
	→ Clean the electrical contacts on the camera and lens, use a Canon lens, or remove and install the battery pack again (p.25, 26, 36).
02	<b>Card cannot be accessed. Reinsert/change card or format card with camera.</b>
	→ Remove and insert the card again, replace the card, or format the card (p.37, 59).
04	<b>Cannot save images because card is full. Replace card.</b>
	→ Replace the card, erase unnecessary images, or format the card (p.37, 304, 59).
05	<b>The built-in flash could not be raised. Turn the camera off and on again.</b>
	→ Operate the power switch (p.40).
06	<b>Sensor cleaning could not be performed. Turn the camera off and on again.</b>
	→ Operate the power switch (p.40).
10, 20 30, 40 50, 60 70, 80 99	<b>An error prevented shooting. Turn the camera off and on again or re-install the battery.</b>
	→ Operate the power switch, remove and install the battery pack again, or use a Canon lens (p.40, 36, 45).

\* If the error still persists, write down the error number and contact your nearest Canon Service Center.

# Handling Precautions: STM Lenses (Kit Lenses)

Kit lenses\* use a stepping motor that drives the focus lens. The motor controls the focus lens even during zooming.

\* EF-S18-55mm f/3.5-5.6 IS STM, EF-S18-135mm f/3.5-5.6 IS STM, and EF-S55-250mm f/4-5.6 IS STM

## 1. When the camera is OFF

The motor does not operate while the camera is OFF or when the camera is OFF due to the auto power off function. Therefore, users must be aware of the following points.

- Manual focusing is not possible.
- During zooming, inaccurate focusing may occur.

## 2. When the lens is in sleep mode

If not operated for a certain period of time, this lens will enter sleep mode in order to save power, apart from the camera's auto power off.

To exit sleep mode, press the shutter button halfway.

In sleep mode, the motor will not operate even if the camera is ON.

Therefore, users must be aware of the following points.

- Manual focusing is not possible.
- During zooming, inaccurate focusing may occur.

## 3. During initial reset

When the camera is turned ON or when the camera is turned ON by pressing the shutter button halfway when the camera is OFF due to the auto power off function\*<sup>1</sup>, the lens performs an initial reset of the focus lens.

- Although the image in the viewfinder will appear out of focus during the initial reset, this is not a malfunction.
- Wait approx. 1 second\*<sup>2</sup> until the initial reset has completed before shooting.

\*1: Applicable to the following EF-S lens compatible digital SLR cameras:  
EOS 7D Mark II, EOS 7D, EOS 70D, EOS 60D, EOS 60Da, EOS 50D, EOS 40D, EOS 30D, EOS 20D, EOS 20Da, EOS REBEL T3i/600D, EOS REBEL T2i/550D, EOS REBEL T1i/500D, EOS REBEL XSi/450D, EOS REBEL T5/1200D, EOS REBEL T3/1100D, EOS REBEL XS/1000D, EOS DIGITAL REBEL XTi/400D DIGITAL, EOS DIGITAL REBEL XT/350D DIGITAL, EOS DIGITAL REBEL/300D DIGITAL

\*2: The initial reset time varies depending on the camera used.

# Specifications

## • Type

Type:	Digital, single-lens reflex, AF/AE camera with built-in flash
Recording media:	SD/SDHC*/SDXC* memory cards * Compatible with UHS-I cards
Image sensor size:	Approx. 22.3 x 14.9 mm
Compatible lenses:	Canon EF lenses (including EF-S lenses) * Excluding EF-M lenses (35 mm-equivalent focal length is approx. 1.6 times the lens focal length)
Lens mount:	Canon EF mount

## • Image Sensor

Type:	CMOS sensor
Effective pixels:	Approx. 24.2 megapixels * Rounded off to the nearest 10,000th.
Aspect ratio:	3:2
Dust delete feature:	Auto/Manual, Appending Dust Delete Data

## • Recording System

Recording format:	Design rule for Camera File System (DCF) 2.0
Image type:	JPEG, RAW (14-bit Canon original) RAW+JPEG Large simultaneous recording possible
Recorded pixels:	L (Large) : 24 megapixels (6000 x 4000) M (Medium) : Approx. 10.6 megapixels (3984 x 2656) S1 (Small 1) : Approx. 5.9 megapixels (2976 x 1984) S2 (Small 2) : Approx. 2.5 megapixels (1920 x 1280) S3 (Small 3) : Approx. 350,000 pixels (720 x 480) RAW : 24 megapixels (6000 x 4000)
Aspect ratio:	3:2, 4:3, 16:9, 1:1
Create/select a folder:	Possible
File numbering:	Continuous, Auto reset, Manual reset

## • Image Processing During Shooting

Picture Style:	Auto, Standard, Portrait, Landscape, Neutral, Faithful, Monochrome, User Def. 1 - 3
Basic+:	Ambience-based shots, Light/scene-based shots
Extra Effect Shot:	Possible (in <CA> mode)
White balance:	Auto, Preset (Daylight, Shade, Cloudy, Tungsten light, White fluorescent light, Flash), Custom White Balance correction and White balance bracketing possible * Flash color temperature information transmission enabled



Noise reduction:	Applicable to long exposures and high ISO speed shots
Automatic image brightness correction:	Auto Lighting Optimizer
Highlight tone priority:	Provided
Lens aberration correction:	Peripheral illumination correction, Chromatic aberration correction, Distortion correction

### • Viewfinder

Type:	Eye-level pentamirror
Coverage:	Vertical/Horizontal approx. 95% (with Eye point approx. 19 mm) * Vertical field of view in the 16:9 aspect ratio is approx. 93%.
Magnification:	Approx. 0.82x (-1 m <sup>-1</sup> with 50mm lens at infinity)
Eye point:	Approx. 19 mm (from eyepiece lens center at -1 m <sup>-1</sup> )
Built-in diopter adjustment:	Approx. -3.0 - +1.0 m <sup>-1</sup> (dpt)
Focusing screen:	Fixed, Precision Matte
Grid display:	Possible
Mirror:	Quick-return type
Depth-of-field preview:	Provided

### • Autofocus

Type:	TTL secondary image-registration, phase-difference detection with the dedicated AF sensor
AF points:	19 points (cross-type AF point: max. 19 points) * With certain lenses, cross-type focusing at the peripheral AF points is not possible. * Dual cross-type focusing at f/2.8 with center AF point. (Except with the EF28-80mm f/2.8-4L USM and EF50mm f/2.5 Compact Macro.)
Focusing brightness range:	EV -0.5 - 18 (Conditions: f/2.8-sensitive center AF point, One-Shot AF, room temperature, ISO 100)
Focus operation:	One-Shot AF, AI Servo AF, AI Focus AF Manual focusing (MF)
AF area selection mode:	Single-point AF (Manual selection), Zone AF (Manual selection of zone), 19-point automatic selection AF
Condition of AF point automatic selection:	AF point can be selected automatically in One-Shot AF mode, using information on colors equivalent to skin tones.
AF-assist beam:	Small series of flashes fired by built-in flash

## • Exposure Control

Metering mode:	63-zone TTL full-aperture metering using 7560-pixel RGB plus IR metering sensor <ul style="list-style-type: none"><li>• Evaluative metering (linked to all AF points)</li><li>• Partial metering (approx. 6.0% of viewfinder at center)</li><li>• Spot metering (approx. 3.5% of viewfinder at center)</li><li>• Center-weighted average metering</li></ul>
Metering brightness range:	EV 1 - 20 (at room temperature, ISO 100)
Exposure control:	Program AE (Scene Intelligent Auto, Flash Off, Creative Auto, Portrait, Landscape, Close-up, Sports, Special scene modes (Kids, Food, Candlelight, Night Portrait, Handheld Night Scene, HDR Backlight Control), Program), Shutter-priority AE, Aperture-priority AE, Manual exposure
ISO speed (Recommended exposure index):	Basic Zone modes*: ISO 100 - ISO 6400 set automatically <ul style="list-style-type: none"><li>* Landscape: ISO 100 - ISO 1600, &lt;SCN&gt; Handheld Night Scene: ISO 100 - ISO 12800</li></ul> Creative Zone modes: ISO 100 - ISO 12800 set manually (whole-stop increments), ISO 100 - ISO 6400 set automatically, maximum ISO speed settable for ISO Auto, or ISO expansion to "H" (equivalent to ISO 25600)
Exposure compensation:	Manual: $\pm 5$ stops in 1/3- or 1/2-stop increments AEB: $\pm 2$ stops in 1/3- or 1/2-stop increments (can be combined with manual exposure compensation)
AE lock:	Auto: Applied in One-Shot AF with evaluative metering when focus is achieved Manual: By AE lock button
Anti-flicker:	Possible

## • Shutter

Type:	Electronically-controlled, focal-plane shutter
Shutter speed:	1/4000 sec. to 30 sec. (Total shutter speed range. Available range varies by shooting mode.), Bulb, X-sync at 1/200 sec.

## • Drive System

Drive modes:	Single shooting, Continuous shooting, Silent single shooting, Silent continuous shooting, Self-timer: 10-sec. delay/remote control, 2-sec. delay, 10-sec. delay with continuous shooting
Continuous shooting speed:	Continuous shooting: Max. approx. 5.0 shots/sec. Silent continuous shooting: Max. approx. 3.0 shots/sec.

Max. burst (Approx.):	JPEG Large/Fine: 180 (940) shots RAW: 7 (8) shots RAW+JPEG Large/Fine: 6 (6) shots * Figures are based on Canon's testing standards (3:2 aspect ratio, ISO 100 and Standard Picture Style) using an 8 GB card. * Figures in parentheses apply to an UHS-I compatible 8 GB card based on Canon's testing standards.
-----------------------	--

## • Flash

Built-in flash:	Retractable, auto pop-up flash Guide No.: Approx. 12/39.4 (ISO 100, in meters/feet) Flash coverage: Approx. 17mm lens angle of view Recycling time approx. 3 sec.
External flash:	EX-series Speedlite
Flash metering:	E-TTL II autofocus
Flash exposure compensation:	±2 stops in 1/3- or 1/2-stop increments
FE lock:	Provided
PC terminal:	None
Flash control:	Built-in flash function settings, external Speedlite function settings, external Speedlite Custom Function settings Wireless flash control via optical transmission possible

## • Live View Shooting

Focus method:	Hybrid CMOS AF III System (Face+Tracking, FlexiZone-Multi, FlexiZone-Single), Manual focus (approx. 5x / 10x magnification possible)
Continuous AF:	Provided
Focusing brightness range:	EV 0 - 18 (at room temperature, ISO 100)
Touch shutter:	Provided
Metering mode:	Real-time metering with image sensor Evaluative metering (315 zones), Partial metering (approx. 10% of Live View screen), Spot metering (approx. 2.7% of Live View screen), Center-weighted average metering
Metering brightness range:	EV 0 - 20 (at room temperature, ISO 100)
Creative Filter:	Grainy B/W, Soft focus, Fish-eye effect, Art bold effect, Water painting effect, Toy camera effect, Miniature effect
Grid display:	Two types

## • Movie Shooting

Recording format:	MP4
Movie:	MPEG-4 AVC/H.264
Audio:	Variable (average) bit rate AAC
Recording size and frame rate:	Full HD (1920x1080) : 29.97p/25.00p/23.98p HD (1280x720) : 59.94p/50.00p/29.97p/25.00p VGA (640x480) : 29.97p/25.00p
Compression method:	Standard/Light
File size:	Full HD (29.97p/25.00p/23.98p) (Standard) : Approx. 216 MB/min. Full HD (29.97p/25.00p) (Light) : Approx. 87 MB/min. HD (59.94p/50.00p) (Standard) : Approx. 187 MB/min. HD (29.97p/25.00p) (Light) : Approx. 30 MB/min. VGA (29.97p/25.00p) (Standard): Approx. 66 MB/min. VGA (29.97p/25.00p) (Light) : Approx. 23 MB/min.
Focus method:	Same as focusing with Live View shooting
Movie Servo AF:	Provided
Focusing brightness range:	EV 0 - 18 (at room temperature, ISO 100)
Metering mode:	Center-weighted average and evaluative metering with the image sensor * Automatically set by the focus method.
Metering brightness range:	EV 0 - 20 (at room temperature, ISO 100)
Exposure control:	Program AE for movies and manual exposure
Exposure compensation:	±3 stops in 1/3- or 1/2-stop increments
ISO speed (Recommended exposure index):	With autoexposure shooting: ISO 100 - ISO 6400 set automatically With manual exposure: ISO 100 - ISO 6400 set automatically/manually, expandable to H (equivalent to ISO 12800)
Miniature effect movie:	Possible
Video snapshots:	Settable to 2 sec./4 sec./8 sec.
Sound recording:	Built-in stereo microphones External stereo microphone terminal provided Sound-recording level adjustable, wind filter provided, attenuator provided
Grid display:	Two types
Still photo shooting:	Possible

### •LCD Monitor

Type:	TFT color liquid-crystal monitor
Monitor size and dots:	Wide, 7.7 cm (3.0-in.) (3:2) with approx. 1.04 million dots
Brightness adjustment:	Manual (7 levels)
Interface languages:	25
Touch screen technology:	Capacitive sensing
Feature guide:	Displayable

### •Playback

Image display format:	Single-image display (without shooting information), Single-image display (with simple information), Single-image display (Shooting information displayed: Detailed information, Lens/histogram, White balance, Picture Style, Color space/noise reduction, Lens aberration correction), Index display (4/9/36/100 images)
Zoom magnification:	Approx. 1.5x - 10x
Highlight alert:	Overexposed highlights blink
AF point display:	Provided
Image browsing method:	Single image, jump by 10 or 100 images, by shooting date, by folder, by movies, by stills, by rating
Image rotate:	Possible
Ratings:	Provided
Movie playback:	Enabled (LCD monitor, audio/video OUT, HDMI OUT) Built-in speaker
Image protect:	Possible
Slide show:	All images, by date, by folder, by movies, by stills, by rating Five transition effects selectable
Background music:	Selectable for slide shows and movie playback

### •Post-Processing of Images

Creative filters:	Grainy B/W, Soft focus, Fish-eye effect, Art bold effect, Water painting effect, Toy camera effect, Miniature effect
Resize:	Possible
Cropping:	Possible

### •Direct Printing

Compatible printers:	PictBridge-compatible printers
Printable images:	JPEG and RAW images
Print ordering:	DPOF Version 1.1 compatible

## • Custom Functions

Custom Functions:	13
My Menu registration:	Possible
Copyright information:	Entry and inclusion enabled

## • Interface

Audio/video OUT/Digital terminal:	Analog video (compatible with NTSC/PAL)/stereo audio output Hi-Speed USB equivalent: Computer communication, Direct printing, GPS Receiver GP-E2, Connect Station CS100 connection
HDMI mini OUT terminal:	Type C (Auto switching of resolution), CEC-compatible
External microphone IN terminal:	3.5 mm diameter stereo mini-jack
Remote control terminal:	For Remote Switch RS-60E3
Wireless remote control:	Compatible with Remote Controller RC-6
Eye-Fi card:	Compatible

## • Power

Battery:	Battery Pack LP-E17 (Quantity 1) * AC power can be supplied via AC Adapter Kit ACK-E18
Number of possible shots:	With viewfinder shooting: Approx. 440 shots at room temperature (23°C/73°F), approx. 400 shots at low temperatures (0°C/32°F) With Live View shooting: Approx. 180 shots at room temperature (23°C/73°F), approx. 150 shots at low temperatures (0°C/32°F) * With a fully-charged Battery Pack LP-E17
Movie shooting time:	Approx. 1 hr. 20 min. at room temperature (23°C/73°F) Approx. 1 hr. at low temperatures (0°C/32°F) * With a fully-charged Battery Pack LP-E17

## • Dimensions and Weight

Dimensions (W x H x D):	Approx. 131.9 x 100.7 x 77.8 mm / 5.20 x 3.97 x 3.07 in.
Weight:	Approx. 555 g / 19.58 oz. (CIPA Guidelines), Approx. 510 g / 17.99 oz. (Body only)

## • Operation Environment

Working temperature range:	0°C - 40°C / 32°F - 104°F
Working humidity:	85% or less

### • Battery Pack LP-E17

Type:	Rechargeable lithium-ion battery
Rated voltage:	7.2 V DC
Battery capacity:	1040 mAh
Working temperature range:	During charging: 5°C - 40°C / 41°F - 104°F During shooting: 0°C - 40°C / 32°F - 104°F
Working humidity:	85% or less
Dimensions (W x H x D):	Approx. 33.0 x 14.0 x 49.4 mm / 1.30 x 0.55 x 1.94 in.
Weight:	Approx. 45 g / 1.59 oz. (excluding protective cover)

### • Battery Charger LC-E17

Compatible battery:	Battery Pack LP-E17
Recharging time:	Approx. 2 hours (at room temperature (23°C/73°F))
Rated input:	100 - 240 V AC (50/60 Hz)
Rated output:	8.4 V DC / 700 mA
Working temperature range:	5°C - 40°C / 41°F - 104°F
Working humidity:	85% or less
Dimensions (W x H x D):	Approx. 67.3 x 27.7 x 92.2 mm / 2.65 x 1.09 x 3.63 in. (prongs retracted)
Weight:	Approx. 85 g / 3 oz.

### • Battery Charger LC-E17E

Compatible battery:	Battery Pack LP-E17
Recharging time:	Approx. 2 hours (at room temperature (23°C/73°F))
Rated input:	100 - 240 V AC (50/60 Hz)
Rated output:	8.4 V DC / 700 mA
Working temperature range:	5°C - 40°C / 41°F - 104°F
Working humidity:	85% or less
Dimensions (W x H x D):	Approx. 67.3 x 27.7 x 92.2 mm / 2.65 x 1.09 x 3.63 in. (excluding power cord)
Weight:	Approx. 80 g / 2.82 oz. (excluding power cord)

• **EF-S18-55mm f/3.5-5.6 IS STM**

Focal length / Aperture:	18 mm-55 mm f/3.5-5.6
Lens construction:	13 elements in 11 groups
Minimum aperture:	f/22 - 36 * f/22-38 when 1/2-stop increments set for aperture.
Angle of view:	Diagonal extent: 74°20' - 27°50' Vertical extent: 45°30' - 15°40' Horizontal extent: 64°30' - 23°20'
Closest focusing distance:	0.25 m / 0.82 ft.
Max. magnification:	0.36x (at 55 mm focal length)
Field of view:	Approx. 129 x 199 - 42 x 63 mm / 5.08 x 7.83 - 1.65 x 2.48 in. (at 0.25 m / 0.82 ft.)
Filter size:	58 mm
Max. diameter x length:	Approx. 69.0 x 75.2 mm / 2.72 x 2.96 in.
Weight:	Approx. 205 g / 7.2 oz.
Hood:	EW-63C (sold separately)
Lens cap:	E-58 II
Case:	LP1016 (sold separately)

• **EF-S18-135mm f/3.5-5.6 IS STM**

Focal length / Aperture:	18 mm-135 mm f/3.5-5.6
Lens construction:	16 elements in 12 groups
Minimum aperture:	f/22 - 36 * f/22-38 when 1/2-stop increments set for aperture.
Angle of view:	Diagonal extent: 74°20' - 11°30' Vertical extent: 45°30' - 6°20' Horizontal extent: 64°30' - 9°30'
Closest focusing distance:	0.39 m / 1.28 ft.
Max. magnification:	0.28x (at 135 mm focal length)
Field of view:	Approx. 248 x 372 - 53 x 80 mm / 9.76 x 14.65 - 2.09 x 3.15 in. (at 0.39 m / 1.28 ft.)
Filter size:	67 mm
Max. diameter x length:	Approx. 76.6 x 96.0 mm / 3.02 x 3.78 in.
Weight:	Approx. 480 g / 16.9 oz.
Hood:	EW-73B (sold separately)
Lens cap:	E-67 II
Case:	LP1116 (sold separately)



### • EF-S55-250mm f/4-5.6 IS STM

Focal length / Aperture:	55 mm-250 mm f/4-5.6
Lens construction:	15 elements in 12 groups
Minimum aperture:	f/22 - 32
Angle of view:	Diagonal extent: 27°50' - 6°15' Vertical extent: 15°40' - 3°30' Horizontal extent: 23°20' - 5°20'
Closest focusing distance:	0.85 m / 2.79 ft.
Max. magnification:	0.29x (at 250 mm focal length)
Field of view:	Approx. 197 x 296 - 52 x 78 mm / 7.76 x 11.69 - 2.05 x 3.07 in. (at 0.85 m / 2.79 ft.)
Filter size:	58 mm
Max. diameter x length:	Approx. 70.0 x 111.2 mm / 2.76 x 4.38 in.
Weight:	Approx. 375 g / 13.2 oz.
Hood:	ET-63 (sold separately)
Lens cap:	E-58 II
Case:	LP1019 (sold separately)

- All the data above is based on Canon's testing standards and CIPA (Camera & Imaging Products Association) testing standards and guidelines.
- Dimensions, maximum diameter, length and weight listed above are based on CIPA Guidelines (except weight for camera body only).
- Product specifications and the exterior are subject to change without notice.
- If a problem occurs with a non-Canon lens attached to the camera, consult the respective lens manufacturer.

## Trademarks

- Adobe is a trademark of Adobe Systems Incorporated.
- Microsoft and Windows are trademarks or registered trademarks of Microsoft Corporation in the United States and/or other countries.
- Macintosh and Mac OS are trademarks of Apple Inc., registered in the U.S. and other countries.
- SDXC logo is a trademark of SD-3C, LLC.
- HDMI, HDMI logo, and High-Definition Multimedia Interface are trademarks or registered trademarks of HDMI Licensing LLC.
- All other trademarks are the property of their respective owners.

## About MPEG-4 Licensing

"This product is licensed under AT&T patents for the MPEG-4 standard and may be used for encoding MPEG-4 compliant video and/or decoding MPEG-4 compliant video that was encoded only (1) for a personal and non-commercial purpose or (2) by a video provider licensed under the AT&T patents to provide MPEG-4 compliant video. No license is granted or implied for any other use for MPEG-4 standard."

\* Notice displayed in English as required.

### **Use of genuine Canon accessories is recommended**

This product is designed to achieve excellent performance when used with genuine Canon accessories.

Canon shall not be liable for any damage to this product and/or accidents such as fire, etc., caused by the malfunction of non-genuine Canon accessories (e.g., a leakage and/or explosion of a battery pack). Please note that this warranty does not apply to repairs arising out of the malfunction of non-genuine Canon accessories, although you may request such repairs on a chargeable basis.

## Digital Camera Model DS126571 Systems

This device complies with Part 15 of the FCC Rules. Operation is subject to the following two conditions: (1) This device may not cause harmful interference, and (2) this device must accept any interference received, including interference that may cause undesired operation.

**Note:** This equipment has been tested and found to comply with the limits for class B digital devices, pursuant to Part 15 of the FCC Rules. These limits are designed to provide reasonable protection against harmful interference in a residential installation. This equipment generates, uses and can radiate radio frequency energy and, if not installed and used in accordance with the instructions, may cause harmful interference to radio communications. However, there is no guarantee that interference will not occur in a particular installation. If this equipment does cause harmful interference to radio or television reception, which can be determined by turning the equipment off and on, the user is encouraged to try to correct the interference by one or more of the following measures:

- Reorient or relocate the receiving antenna.
- Increase the separation between the equipment and receiver.
- Connect the equipment into an outlet on a circuit different from that to which the receiver is connected.
- Consult the dealer or an experienced radio/TV technician for help.

The cable with the ferrite core provided with the digital camera must be used with this equipment in order to comply with Class B limits in Subpart B of Part 15 of the FCC rules.

Do not make any changes or modifications to the equipment unless otherwise specified in the manual. If such changes or modifications should be made, you could be required to stop operation of the equipment.

Canon U.S.A. Inc.  
One Canon Park, Melville, NY 11747, U.S.A.  
Tel No. 1-800-OK-CANON (1-800-652-2666)

CAN ICES-3 (B) / NMB-3 (B)



When connecting to and using a household power outlet, use only AC Adapter Kit ACK-E18 (rated input: 100-240 V AC 50/60 Hz, rated output: 8.0 V DC). Using anything else can cause fire, overheating, or electrical shock.



USA and Canada only:

The Lithium ion/polymer battery that powers the product is recyclable. Please call 1-800-8-BATTERY for information on how to recycle this battery.

For CA, USA only

Included lithium battery contains Perchlorate Material – special handling may apply. See [www.dtsc.ca.gov/hazardouswaste/perchlorate/](http://www.dtsc.ca.gov/hazardouswaste/perchlorate/) for details.

### **CAUTION**

RISK OF EXPLOSION IF BATTERY IS REPLACED BY AN INCORRECT TYPE.  
DISPOSE OF USED BATTERIES ACCORDING TO LOCAL REGULATION.



# 15

## Viewing the CD-ROM Instruction Manuals / Downloading Images to Your Computer

This chapter explains how to view the Camera Instruction Manual CD-ROM on your computer, download images from the camera to your computer, gives an overview of the software in the EOS DIGITAL Solution Disk (CD-ROM), and explains how to install the software on your computer. It also explains how to view the Software Instruction Manuals.



**Camera Instruction  
Manual**



**EOS DIGITAL Solution Disk**  
(Software/Software Instruction Manuals)

# Viewing the Camera Instruction Manual CD-ROM



The Camera Instruction Manual CD-ROM contains instruction manuals (PDF files) related to this product.

## Viewing the Camera Instruction Manual CD-ROM

To view the instruction manuals (PDF files), Adobe Reader 6.0 or higher must be installed on your computer. Adobe Reader can be downloaded free from the Internet. After installing Adobe Reader, follow the procedure below.

### 1 Insert the “CAMERA INSTRUCTION MANUAL” CD-ROM into your computer.



### 2 Double-click the CD-ROM.

- With Windows, double-click on the CD-ROM icon in [(My) Computer]. With Macintosh, double-click on the CD-ROM icon on the desktop.
- The icon displayed will differ depending on your computer’s operating system.



### 3 Double-click the START file.

- The icon displayed will differ depending on your computer’s operating system.



**4 Click your language.**

**5 Click the instruction manual you want to read.**

▶ The manual will be displayed.



- You can save the PDF file to your computer.
- To learn how to use Adobe Reader, refer to Adobe Reader's Help section.

# Downloading Images to a Computer

You can use the EOS software to download the images in the camera to your computer. There are two ways to do this.

## Downloading by Connecting the Camera to the Computer

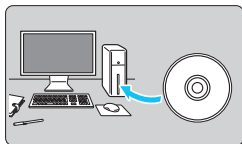

**1** Install the software (p.405).

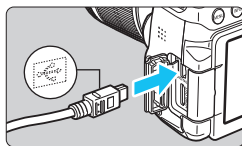

**2** Use the provided interface cable to connect the camera to your computer.

- Use the interface cable provided with the camera.
- Connect the cable to the camera's digital terminal with the cable plug's <img alt="USB symbol" data-bbox="455 515 485 535"/> icon facing the front of the camera.
- Connect the cord's plug to the computer's USB terminal.

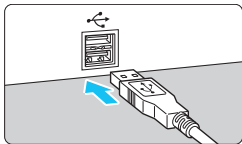

**3** Use EOS Utility to download the images.

- Refer to the EOS Utility Instruction Manual (p.406).

 If [**Wi-Fi/NFC**] is set to [**Enable**], the camera cannot be connected to a computer. Set [**Wi-Fi/NFC**] to [**Disable**], then reconnect the camera to a computer with an interface cable.

## Downloading Images with a Card Reader

You can also use a card reader to download images to your computer.

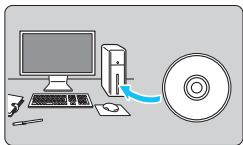

**1 Install the software** (p.405).

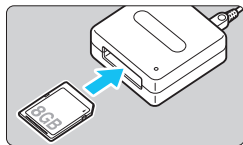

**2 Insert the card into the card reader.**

**3 Use Digital Photo Professional to download the images.**

- Refer to the Digital Photo Professional Instruction Manual (p.406).



When downloading images from the camera to your computer with a card reader without using EOS software, copy the DCIM folder on the card to your computer.

# Software Overview



## **EOS DIGITAL Solution Disk**

Various software for EOS DIGITAL cameras are contained on the EOS DIGITAL Solution Disk.

### **EOS Utility**

With the camera connected to a computer, EOS Utility enables you to transfer still photos and movies shot with the camera to the computer. You can use this software to set various camera settings and shoot remotely from the computer connected to the camera. Also, you can copy background music tracks, such as EOS Sample Music\*, to the card.

\* You can use the background music as the soundtrack for a video snapshot album, movie, or slide show played back with your camera.

### **Digital Photo Professional**

This software is recommended for users who shoot RAW images. You can view, edit, and print RAW images and JPEG images.

\* Some functions differ between the version to be installed on a 64-bit computer and that to be installed on a 32-bit computer.

### **Picture Style Editor**

You can edit Picture Styles, and create and save original Picture Style files. This software is aimed at advanced users who are experienced in processing images.

## Installing the Software



- **Do not connect the camera to your computer before you install the software. The software will not be installed correctly.**
- If a previous version is installed, follow the steps below to reinstall the software. (The newer version will overwrite the previous version.)

### **1 Insert the EOS DIGITAL Solution Disk into your computer.**

- For Macintosh, double-click to open the CD-ROM icon displayed on the desktop, then double-click on **[setup]**.

### **2 Click [Easy Installation] and follow the on-screen instructions to install.**

- If the install screen for “Microsoft Silverlight” is displayed during installation, install “Microsoft Silverlight”.

### **3 Click [Restart] and remove the CD-ROM after the computer restarts.**

- When the computer has restarted, the installation is complete.

# Software Instruction Manual



Software Instruction Manuals are contained on the EOS DIGITAL Solution Disk. You can copy and view the software instruction manual (PDF files) as follows:

## 1 Insert the EOS DIGITAL Solution Disk into your computer.

## 2 Close the install screen.

- When the EOS DIGITAL Solution Disk install screen appears, close the install screen.

## 3 Open the CD-ROM.

## 4 Open the [Manual] folder.

## 5 Copy the [English] folder to your computer.

- Instruction Manual PDFs with the names below are copied.

	Windows	Macintosh
EOS Utility	EUx.xW_E_xx	EUx.xM_E_xx
Digital Photo Professional	DPPx.xW_E_xx	DPPx.xM_E_xx
Picture Style Editor	PSEx.xW_E_xx	PSEx.xM_E_xx

## 6 Double-click the copied PDF file.

- Adobe Reader (most recent version recommended) must be installed on your computer.
- Adobe Reader can be downloaded free from the Internet.

# Index

## Numerics

10- or 2-sec. self-timer .....	114
1280x720 .....	233
1920x1080 .....	233
19-point AF auto selection .....	104
640x480 .....	233

## A

 (Scene Intelligent Auto) .....	66
AC Adapter Kit .....	349
Access lamp .....	38
Accessories .....	3
Adobe RGB .....	146
AE lock .....	162
AEB (Auto exposure bracketing) ...	160, 338
AF AF area selection mode .....	104
AF method .....	206, 248
AF operation .....	100
AF point .....	104
AF point selection .....	106
AF-assist beam .....	340
Beep (Beeper) .....	256
Difficult subjects for AF .....	110, 212
Manual focusing (MF) .....	111, 216
Out of focus .....	48, 49, 110, 212
Recomposing .....	69
AI FOCUS (AI Focus AF) .....	102
AI SERVO (AI Servo AF) .....	69, 102
Ambience-based shots .....	90
Angle of view .....	46
Anti-flicker shooting .....	144
Aperture-priority AE .....	152
Area AF frame .....	29
Art bold effect .....	202, 314
Aspect ratio .....	120
Attenuator .....	251
Auto Lighting Optimizer .....	136

Auto Playback .....	294
Auto power off .....	40, 257
Auto reset .....	262
Auto rotate vertical images .....	265
Autofocus (AF) .....	100
Automatic selection of AF point .....	104, 108
Av (Aperture-priority AE) .....	152
A/V OUT (Audio/video output) .....	301

## B

B/W (Monochrome) .....	126, 129
Background blur .....	74
Background music .....	297
Basic Zone modes .....	30
Battery .....	34, 36, 41
Battery check .....	41
Battery Grip .....	41, 360
Beep (Beeper) .....	256
Black-and-white image ...	90, 126, 129
Bracketing .....	135, 160
Brightness (exposure) .....	159
Auto exposure bracketing (AEB) .....	160, 338
Autoexposure lock (AE lock) ...	162
Exposure compensation .....	159
Measurement method (metering mode) .....	157
Built-in flash .....	166
BULB (bulb exposure) .....	156

## C

 (Creative Auto) .....	72
Cable .....	3, 298, 301, 320, 360, 402
Camera Camera shake .....	163
Clear camera settings .....	267
Holding the camera .....	49
Settings display .....	266

Camera shake ..... 48, 49  
 Candlelight ..... 83  
 Cards ..... 24, 37, 59  
   Card reminder ..... 256  
   Formatting ..... 59  
   Low-level formatting ..... 60  
   SD speed class ..... 5  
   Troubleshooting ..... 38, 60  
   Write-protect switch ..... 37  
 Center-weighted average  
   metering ..... 158  
 Charger ..... 32, 34  
 Chromatic aberration correction ... 141  
 Cleaning (image sensor) ..... 271, 274  
 Clear camera settings ..... 267  
 Clipped highlights ..... 310  
 Close-up ..... 78  
 Color saturation ..... 128  
 Color space  
   (color reproduction range) ..... 146  
 Color temperature ..... 132  
 Color tone ..... 82, 83, 128  
 Continuous AF ..... 204  
 Continuous file numbering ..... 261  
 Continuous shooting ..... 112  
 Contrast ..... 128  
 Copyright information ..... 263  
 Creative Auto ..... 72  
 Creative filters ..... 200, 312  
 ☆ (Creative Zone) icon ..... 8  
 Creative Zone modes ..... 30  
 Cropping ..... 317  
 Cross-type focusing ..... 109  
 Custom Functions ..... 336  
 Custom white balance ..... 133

**D**

Date/time ..... 42  
 Daylight saving time ..... 43  
 DC Coupler ..... 349  
 Default settings tables ..... 268  
 Depth-of-field preview ..... 154  
 Detailed information ..... 307  
 Digital terminal ..... 320, 402  
 Dioptic adjustment ..... 49  
 Direct printing ..... 320  
 Distortion correction ..... 141  
 Downloading images ..... 403  
 DPOF ..... 329  
 Dragging ..... 57  
 Drive mode ..... 28, 75, 112, 114  
 Dust Delete Data ..... 272

**E**

Erasing images ..... 304  
 Error codes ..... 382  
 Evaluative metering ..... 157  
 Exposure compensation ..... 159  
 Exposure level increments ..... 338  
 External flash ..... 171  
 Extra Effect Shot ..... 73  
 Eyecup ..... 351  
 Eye-Fi card ..... 352  
 Eyepiece cover ..... 33, 351

**F**















FE lock ..... 169  
 Feature guide ..... 64  
 FEB (Flash exposure bracketing) ... 176  
 File extension ..... 262  
 File name ..... 261  
 File size ..... 117, 235, 307  
 Filter effect ..... 129, 312



- Final image simulation ..... 197, 229
- Fine (image-recording quality) ..... 28
- Firmware version ..... 366
- First-curtain synchronization ..... 177
- Fish-eye effect ..... 202, 314
- Flash
- Built-in flash ..... 166
  - Custom Functions ..... 178
  - Effective range ..... 166
  - External flash ..... 171
  - FE lock ..... 169
  - Flash control ..... 173
  - Flash exposure bracketing (FEB) ... 176
  - Flash exposure compensation ... 168
  - Flash off ..... 71, 75, 89
  - Flash sync speed ..... 172
  - Manual flash ..... 177, 190
  - Red-eye reduction ..... 167
  - Shutter synchronization  
(1st/2nd curtain) ..... 177
  - Wireless ..... 177
- Flash mode ..... 176, 177
- Flash sync contacts ..... 26
- Flicker detection ..... 29, 63
- Focus indicator ..... 66
- Focus lock ..... 69
- Focus mode switch ..... 45, 111, 216
- Focusing → AF
- Focusing point (AF point) ..... 104
- Folder creation/selection ..... 259
- Food ..... 82
- Formatting (card initialization) ..... 59
- Frame rate ..... 233
- Full High-Definition  
(Full HD) ..... 221, 288, 298
- Fully automatic shooting (Scene  
Intelligent Auto) ..... 66
- Functions settable by shooting  
mode ..... 354
- G**
- Grainy B/W ..... 202, 313
- Grid ..... 62, 204, 250
- H**
- Handheld Night Scene ..... 85
- HD ..... 288, 298
- HDMI ..... 288, 298
- HDMI CEC ..... 299
- HDR Backlight Control ..... 86
- High ISO speed noise reduction ... 137
- High-Definition (HD) movies ... 288, 298
- Highlight alert ..... 310
- Highlight tone priority ..... 339
- Histogram (Brightness/RGB) ..... 310
- Hot shoe ..... 26, 171
- Household power ..... 349
- I**
- ICC profile ..... 146
- Image dust prevention ..... 271
- Image review time ..... 257
- Image-recording quality ..... 116
- Images
- AF point display ..... 309
  - Auto playback ..... 294
  - Auto rotate ..... 265
  - Erasing ..... 304
  - File numbering ..... 261
  - Highlight alert ..... 310
  - Histogram ..... 310
  - Index display ..... 278
  - Jump display  
(image browsing) ..... 279
  - Magnified view ..... 280
  - Manual rotate ..... 283
  - Playback ..... 97, 277
  - Protecting ..... 302
  - Rating ..... 284
  - Review time ..... 257

- Shooting information ..... 306
  - Slide show ..... 294
  - Transfer ..... 352
  - Viewing on a TV set ..... 288, 298
  - Index display ..... 278
  - INFO. button ..... 97
  - ISO speed ..... 122
    - Automatic setting (Auto) ..... 124
    - ISO expansion ..... 338
    - Maximum ISO speed  
for ISO Auto ..... 123
- J**
- JPEG ..... 117
  - Jump display ..... 279
- K**
- Kids ..... 81
- L**
- Landscape ..... 77, 126
  - Language selection ..... 44
  - Large  
(image-recording quality) ..... 28, 315
  - LCD monitor ..... 24, 39
    - Brightness adjustment ..... 258
    - Image playback ..... 97, 277
    - Menu display ..... 53, 362
    - Screen color ..... 270
    - Shooting function  
settings ..... 28, 61
  - Lens ..... 25, 31, 45
    - Chromatic aberration  
correction ..... 141
    - Distortion correction ..... 141
    - Image Stabilizer ..... 48
    - Lock release ..... 46
    - Peripheral illumination  
correction ..... 140
  - Lighting/scene-based shots ..... 94
  - Live View shooting ..... 70, 191
    - Aspect ratio ..... 120
    - Continuous AF ..... 204
    - Face+Tracking ..... 206
    - FlexiZone - Multi ..... 208
    - FlexiZone - Single ..... 210
    - Grid display ..... 204
    - Information display ..... 194
    - Manual focusing (MF) ..... 216
    - Metering timer ..... 205
    - Possible shots ..... 193
    - Quick Control ..... 198
  - Long exposure noise reduction ... 138
  - Long exposures ..... 156
- M**
- M (Manual exposure) ..... 155
  - Macro photography ..... 78
  - Magnification ..... 216, 280
  - Main Dial ..... 26
  - Manual exposure ..... 155, 225
  - Manual focus (MF) ..... 111, 216
  - Manual reset ..... 262
  - Manual selection of AF point ..... 106
  - Maximum burst ..... 117, 118
  - Medium  
(image-recording quality) ..... 28, 315
  - Memory cards → Cards
  - Menu ..... 53
    - My Menu ..... 346
    - Setting procedure ..... 54
    - Settings ..... 362
  - MENU** icon ..... 8
  - Metering mode ..... 157
  - Metering timer ..... 205, 250
  - MF (manual focusing) ..... 111, 216
  - Microphone ..... 222
  - Miniature effect ..... 203, 314
  - Miniature effect movies ..... 236

- Mirror lockup ..... 163, 342
- Mode Dial ..... 30
- Monochrome ..... 90, 126, 129
- Movies ..... 221
- AE lock ..... 162
  - AF method ..... 232, 248
  - Attenuator ..... 251
  - Autoexposure ..... 222
  - Editing ..... 292
  - Editing out first and last scenes... 292
  - Enjoying movies ..... 288
  - File size ..... 235
  - Frame rate ..... 233
  - Grid ..... 250
  - Information display ..... 227
  - Manual exposure shooting ..... 225
  - Manual focus ..... 222
  - Metering timer ..... 250
  - Miniature effect movie ..... 236
  - Movie recording size ..... 233
  - Movie Servo AF ..... 248
  - Playback ..... 290
  - Quick Control ..... 232
  - Recording size ..... 233
  - Recording Time ..... 235
  - Sound recording ..... 251
  - Still photo shooting ..... 230
  - Video snapshot album ..... 238
  - Video snapshots ..... 238
  - Viewing on a TV set ..... 288, 298
  - Wind filter ..... 251
- Multi Shot Noise Reduction ..... 137
- My Menu ..... 346
- N**
- Night Portrait ..... 84
- Night scenes ..... 84, 85
- Noise reduction
- High ISO speed ..... 137
  - Long exposures ..... 138
- Nomenclature ..... 26
- Non-Canon flash units ..... 172
- Normal (image-recording quality) ... 28
- NTSC ..... 233, 366
- O**
- ONE SHOT (One-Shot AF) ..... 101
- P**
- P (Program AE) ..... 148
- PAL ..... 233, 366
- Partial metering ..... 157
- Peripheral illumination correction... 140
- Photobook set-up ..... 333
- PictBridge ..... 319
- Picture Style ..... 125, 127, 130
- Pixel count ..... 116
- Playback ..... 97, 277
- Portrait ..... 76, 126
- Possible shots ..... 41, 117, 193
- Power
- Auto power off ..... 257
  - Battery check ..... 41
  - Battery information ..... 348
  - Household power ..... 349
  - Possible shots ..... 41, 117, 193
  - Recharge ..... 34, 41
  - Recharge performance ..... 348
- Pressing completely ..... 50
- Pressing halfway ..... 50
- Printing ..... 319
- Cropping ..... 327
  - Page layout ..... 323
  - Paper settings ..... 322
  - Photobook set-up ..... 333
  - Print order (DPOF) ..... 329
  - Printing effects ..... 324
  - Tilt correction ..... 327
- Program AE ..... 148
- Program shift ..... 149
- Protecting images ..... 302

- Q**
-  (Quick Control) ..... 51, 88, 198, 232, 286
  - Quick Control .... 51, 88, 198, 232, 286
- R**
- Rating mark ..... 284
  - Ratings ..... 284
  - RAW ..... 28, 117, 119
  - RAW+JPEG ..... 28, 117, 119
  - Recharge ..... 34, 41, 348
  - Red-eye reduction ..... 167
  - Release shutter without card ..... 256
  - Remote control shooting ..... 350
  - Remote switch ..... 351
  - Resizing ..... 315
  - Revert to default settings ..... 267
  - Rotation (image) ..... 265, 283, 327
- S**
- Safety precautions ..... 20
  - Scene icons ..... 196, 224
  - Scene Intelligent Auto ..... 66
  - SD, SDHC, SDXC cards → Cards
  - Second-curtain synchronization .... 177
  - Self-timer ..... 114
  - Sensitivity → ISO speed
  - Sensor cleaning ..... 271, 274
  - Sepia (monochrome) ..... 90, 129
  - Sharpness ..... 128
  - Shooting function settings ..... 28, 61
  - Shooting information display ..... 306
  - Shooting mode ..... 30
    - Av (Aperture-priority AE) ..... 152
    - M (Manual exposure) ..... 155
    - P (Program AE) ..... 148
    - Tv (Shutter-priority AE) ..... 150
    -  (Scene Intelligent Auto) ..... 66
    -  (Flash Off) ..... 71
    -  (Creative Auto) ..... 72
    -  (Portrait) ..... 76
    -  (Landscape) ..... 77
    -  (Close-up) ..... 78
    -  (Sports) ..... 79
    - SCN** (Special scene) ..... 80
      -  (Kids) ..... 81
      -  (Food) ..... 82
      -  (Candlelight) ..... 83
      -  (Night Portrait) ..... 84
      -  (Handheld Night Scene) .... 85
      -  (HDR Backlight Control) .... 86
  - Shutter button ..... 50
  - Shutter synchronization
    - (1st/2nd curtain) ..... 177
  - Shutter-priority AE ..... 150
  - Silent shooting
    - Continuous shooting ..... 112
    - Single shooting ..... 112
  - Single shooting ..... 75, 112, 355, 357, 359
  - Single-image display ..... 97
  - Single-point AF ..... 104
  - Slide show ..... 294
  - Small (image-recording quality) ..... 28, 315
  - Soft focus ..... 202, 313
  - Software ..... 404
  - Speaker ..... 290
  - Special scene mode ..... 80
  - Specifications ..... 384
  - Sports ..... 79
  - Spot metering ..... 157
  - sRGB ..... 146
  - Stop down aperture ..... 154
  - Strap ..... 33
  - System map ..... 360

**T**

Tapping .....	56
Temperature warning .....	218, 253
Time zone .....	42
Tone priority .....	339
Toning effect (monochrome) .....	129
Touch beeping.....	57
Touch screen.....	27, 56, 281
Touch Shutter.....	214
Toy camera effect.....	203, 314
Tripod socket .....	27
Troubleshooting .....	369
Tv (Shutter-priority AE) .....	150

**U**

USB (digital) terminal .....	320, 402
------------------------------	----------

**V**

Video snapshot album .....	238
Video snapshots .....	238
Video system .....	233, 298, 366
Viewfinder .....	29
Dioptic adjustment.....	49
Flicker detection .....	63
Grid display.....	62
Viewing on a TV set.....	288, 298
Volume (movie playback).....	291

**W**

Water painting effect .....	202, 314
WB (white balance).....	132
White balance .....	132
Bracketing.....	135
Correction .....	134
Custom .....	132
Personal .....	133
Wi-Fi.....	364
Wind filter .....	251
Wireless flash shooting.....	179

**Z**

Zone AF.....	104
--------------	-----

# Canon

The descriptions in this Instruction Manual are current as of March 2015. For information on the compatibility with any products introduced after this date, contact any Canon Service Center. For the latest version Instruction Manual, refer to the Canon Web site.